

The delicate curve of a smoke-gray glass canopy arching over your cooktop will add an elegance to your everyday cooking experience. Updated with Zephyr's trend-setting Black Stainless Steel, the Ravenna combines 21st cen-

tury know-how with timeless beauty. Titanium coated for extra durability as well as an anti-smudge coating for easy cleaning. Featuring ACT™ technology, ICON Touch® Controls and a powerful, yet quiet, 600-CFM blower.

ACT™

Min. - Max. CFM	INTERNAL BLOWER STANDARD	INTERNAL BLOWER with ACT™ AIRFLOW CONTROL TECHNOLOGY™*	
	200 - 600	200 - 390	200 - 290
Min. - Max. Sones	1 - 6	1 - 4	1 - 3

*AIRFLOW CONTROL TECHNOLOGY™ (ACT™) is an exclusive feature built into specific Zephyr hoods which can limit the maximum blower CFM to meet local code requirements.

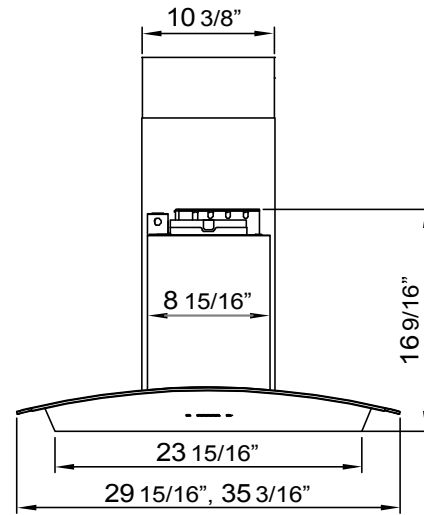
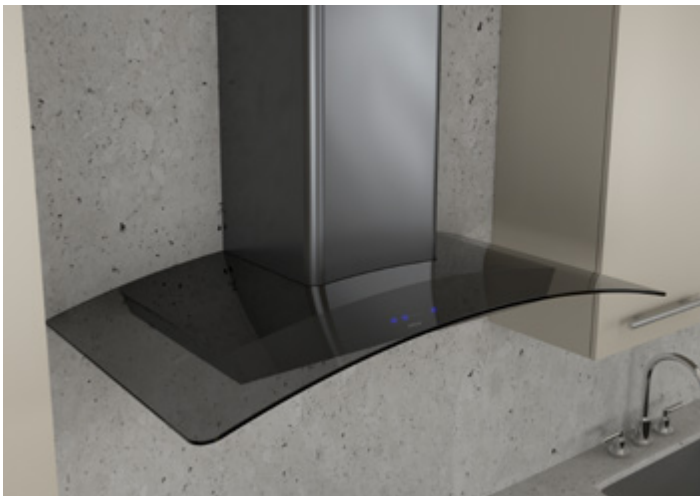

FRONT

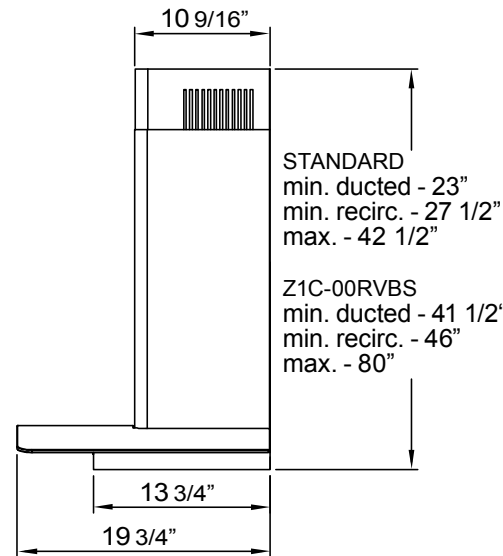

SIDE

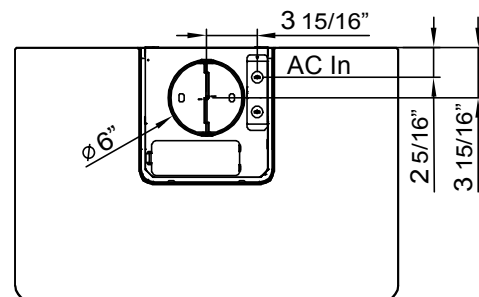

TOP

MODEL

Black Stainless Steel w/ Smoke-Gray Glass	ZRV-E30BBSGG	ZRV-M90BBSGG
--	--------------	--------------

Size	30"	36"
Blower CFM (Min. - Max.)	200 - 600	200 - 600
Sones (Min. - Max.)	1 - 6	1 - 6
ACT 390 CFM (Min. - Max.)	200 - 390	200 - 390
ACT 390 Sones (Min. - Max.)	1 - 4	1 - 4
ACT 290 CFM (Min. - Max.)	200 - 290	200 - 290
ACT 290 Sones (Min. - Max.)	1 - 3	1 - 3

FEATURES

ACT™ Technology	Yes	Yes
Controls	ICON Touch®	ICON Touch®
Speed Levels	5*	5*
Auto Delay-Off	Yes	Yes
Lighting	BriteStrip™ LED, x1	BriteStrip™ LED, x1
Dual-Level Lighting	Yes	Yes
Filters	Aluminum Mesh x1	Aluminum Mesh x1
Recirculating Option	Yes	Yes
Extension Duct Cover Option	Yes, Up to 12' Ceiling	Yes, Up to 12' Ceiling

DUCT SPECIFICATIONS

Vertical Internal Blower	6" Round	6" Round
Horizontal Internal Blower	NA	NA
AC POWER	120V, 60Hz at Max. 4A	120V, 60Hz at Max. 4A

OPTIONAL ACCESSORIES

Recirculating Kit	ZRC-00RV	ZRC-00RV
Extension Duct Cover	Z1C-00RVBS	Z1C-00RVBS
Make-Up Air Kit	MUA006A	MUA006A

MOUNTING HEIGHT RANGE**	26" - 34"	26" - 34"
--------------------------------	-----------	-----------

WARRANTY	3 years parts, 1 year labor	3 years parts, 1 year labor
-----------------	-----------------------------	-----------------------------

CEILING HEIGHT		8'	8.5'	9'	9.5'	10'	10.5'	11'	12'
STANDARD DUCT COVER	Ducted Mounting Height**	26" - 33.5"	26" - 34"	29.5" - 34"	NA	NA	NA	NA	NA
	Recirc Mounting Height**	26" - 28.5"	26" - 34"	29.5" - 34"	NA	NA	NA	NA	NA
EXTENSION DUCT COVER	Ducted Mounting Height**	NA	NA	26" - 30.5"	26" - 34"	26" - 34"	26" - 34"	26" - 34"	28" - 34"
	Recirc Mounting Height**	NA	NA	26" - 26"	26" - 32"	26" - 34"	26" - 34"	26" - 34"	28" - 34"

*When ACT™ is enabled the maximum speed levels will change. ACT 390 CFM = 4 speeds and ACT 290 CFM = 3 speeds.
 **Mounting height refers to distance between top of a 36" tall cooking surface and bottom of hood.

ACT™ AIRFLOW CONTROL TECHNOLOGY™ (ACT™) is an exclusive feature built into specific Zephyr hoods which can limit the maximum blower CFM to meet local code requirements.

Specifications subject to change, check zephyronline.com for up-to-date information.
 Zephyr Ventilation | 2277 Harbor Bay Parkway, Alameda, CA 94502 | 888.880.VENT

JAN17.0101

