



Unified Communications Microphone & Speaker System

YVC-1000

User's Manual



Update the firmware and use the latest features.

You can download the latest firmware and user's manual from the following website:

<http://www.yamaha.com/products/en/communication/download/>

Contents

Introduction

Introduction	3
Available functions	3
About this manual	4
Controls and functions	5
Control Unit (YVC-CTU1000)	5
Microphone (YVC-MIC1000)	9

How to use YVC-1000

Setting up for use	10
Installation	10
Connecting the microphone and power cables	11
Adding microphones and speakers	11
Setup	12
Connecting to communication equipment	13
Connecting to a PC using the USB cable	13
Connecting to a Mac using the USB cable	17
Connecting to a smartphone or tablet via Bluetooth	20
Connecting to a video conference system using audio cables	23

Convenient functions

Using Convenient Functions	25
Using the optional microphone (YVC-MIC1000EX)	25
Using external microphones	26
Using external speakers	27
Using the automatic audio tuning function	28
Changing voice guidance settings	30
Selecting a speaker	31
Adjusting the speaker volume	32
Muting the microphone	32
Muting the speaker	32
Enabling or disabling the Bluetooth function	33
Returning to the factory settings	34

How to use the application

Using the YVC-1000 Configurator	35
Downloading	35
Basic usage	36
Changing the setting of the audio input terminals	37
Changing the setting of the audio output terminals	39
Changing the setting of the USB port	39

Others

Troubleshooting	41
Before inquiry	41
Q1 A button or indicator is turned off or flashing	41
Q2 There is a problem with the audio quality	41
Q3 Others	43
Warning guidance list	44
Using open source software	45

Introduction

Thank you for purchasing a Yamaha YVC-1000. This product is a unified communications microphone and speaker system that serves as an audio terminal when connected to communication equipment, such as a PC or a Mac, a smartphone or tablet, and a video conference system.

Please thoroughly read this manual before installing and connecting the product.

- No part of this manual may be copied or used in any form without permission of Yamaha.
- The contents of this manual apply to the latest specifications as of the publishing date. To obtain the latest manual, access the following website then download the manual file.
<http://www.yamaha.com/products/en/communication/download/>
- Yamaha is not liable for any loss or damage to data resulting from use of the product. Please note that the warranty covers repair of the product only.

Available functions

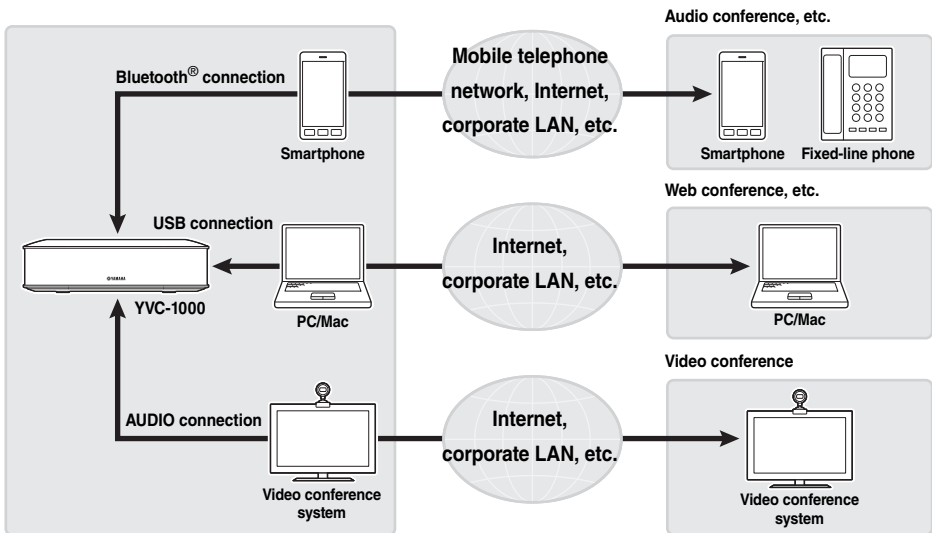

■ Connection with various communication devices

The product is equipped with three connection interfaces: "USB" to enable a connection with a PC or a Mac, "Bluetooth®" to enable a connection with a smartphone or tablet, and "Analog (AUDIO)" to enable a connection with a video conference system. If necessary, you can simultaneously use these three features: USB, Bluetooth®, and Analog (AUDIO) (audio mixer function).

■ "Easy-to-talk" and "easy-to-hear" voice communications

This product employs arrayed microphones with high voice capturing capability and speakers with high voice reproduction capability. The product also provides high-performance audio signal processing functions such as an adaptive echo canceller and noise reduction, realizing "easy-to-talk" and "easy-to-hear" voice communications without skipping or noises.

■ Extension of microphone and speaker

The product allows you to connect an optional microphone (YVC-MIC1000EX) or external speakers to extend the sound pickup range or playback range. This feature offers great flexibility for a layout or a multi-participant conference that cannot be covered by only the product.

■ Connection with external microphones

The product allows you to amplify the sound from connected external microphones, such as handheld microphones, in your location while having a conversation with the remote location.

■ Automatically tuning acoustic settings (Automatic audio tuning function)

The product provides the function that automatically measures acoustic features of the location the product is installed in as well as the positions to place the microphone and speaker, and tunes acoustic settings to the optimal level. Users are not required to make any complicated settings.

■ Notifying operation results or problems using the voice guidance (Voice guidance function)

The product provides the function that notifies results of operations such as a Bluetooth connection, problems in acoustic conditions, or the automatic audio tuning procedure in an easy-to-understand way using the voice guidance.

About this manual

■ About abbreviations

In this manual, the product names are described as follows.

- Yamaha YVC-1000: the product
- Microsoft® Windows®: Windows
- macOS®: macOS

■ About trademarks

- Microsoft and Windows are registered trademarks of Microsoft Corporation in the United States and other countries.
- Mac and macOS are registered trademarks of Apple Inc.
- Android™ is a trademark or registered trademark of Google Inc.
- Bluetooth® is a registered trademark of the Bluetooth SIG and is used by Yamaha in accordance with a license agreement.
- NFC logo (N-Mark) is a trademark or registered trademark of NFC Forum, Inc.

Controls and functions

Control Unit (YVC-CTU1000)

■ Top

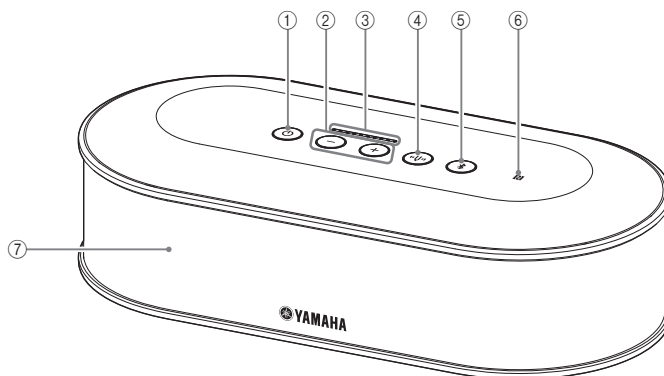

① Power button/indicator (⏻)

Press to turn the product on. Press and hold the power button for two or more seconds to enter standby mode.

② Volume +/- button/indicator (⊕ ⊖)

Press to adjust the speaker volume. Hold down the appropriate button for 0.5 or more seconds to continuously increase or decrease the volume. Press both the + and - buttons (⊕ ⊖) simultaneously for two or more seconds to switch the output device between the built-in and external speakers. (→ page 31)

③ Volume level indicator

It normally indicates the input level of an incoming voice from the remote location or external microphones (if amplifying sound from external microphones in your location is enabled). It indicates settings when adjusting the speaker volume or when selecting an output speaker. (→ page 7)

④ Tuning fork button/indicator (🔊)

It lights up or flashes orange if there is a problem. If a problem is indicated, press the tuning fork button (🔊) to activate the voice guidance about the detected problem.

When it is pressed and held for two or more seconds, the product automatically measures acoustic conditions and tunes the audio settings to an optimal condition (automatic audio tuning). (→ page 28)

⑤ Bluetooth button/indicator (📶)

Press to pair or connect with a Bluetooth compatible smartphone or tablet.

If this button is pressed while being connected to a Bluetooth device, Bluetooth will be disconnected.

⑥ NFC logo (N-Mark)

Placing an NFC (Near Field Communication)-equipped Bluetooth compatible smartphone or tablet over the N-Mark allows you to pair or connect it with the product, or to disconnect it.

⑦ Built-in speaker

Outputs an incoming voice.

■ Indicator status for each button

The status of the product is indicated by the indicator color and the light up/flash mode for each button.

Button type	Button status	Status of the product
Power button (Ⓢ) (page 5: ①)	Not lit	Power-off (the power cable is not plugged into the outlet)
	Lit (Red)	Standby (→ page 11: Step 3)
	Lit (Green)	Power-on (→ page 12)
	Lit (Orange)	Firmware error (→ page 41: Q1)
	Flash (Orange)	Firmware being updated
	Flash (Red)	Hardware error (→ page 41: Q1)
Volume + and - buttons (+)(-) (page 5: ②)	Not lit	Operation disabled
	Lit (Green)	Speaker volume adjustable (→ page 32)
	Flash (Green)	Speaker selectable (→ page 31) Speaker muted (→ page 32)
Tuning fork button (Ⓢ) (page 5: ④)	Not lit	Operation disabled
	Lit (Green)	Acoustic conditions good (→ page 28: Step 4)
	Lit (Orange)	Acoustic conditions bad
	Flash (Orange)	Automatic audio tuning being performed (→ page 28: Step 1)
	High-speed flash (Orange)	Automatic audio tuning has been ended abnormally (→ page 28: Step 4) Acoustic conditions bad (in normal mode)
Bluetooth button (Ⓢ) (page 5: ⑤)	Not lit	Operation disabled
	Lit (Green)	Bluetooth unconnected (→ page 22)
	Flash (Blue)	Bluetooth connectable (→ page 21: Step 2)
	High-speed flash (Blue)	Bluetooth pairing enabled (→ page 20: Step 3)
	Lit (Blue)	Bluetooth connected

■ **Level indicator (page 5: ③)**

The level indicator shows the input level of an incoming voice, speaker volume, or speaker output settings.

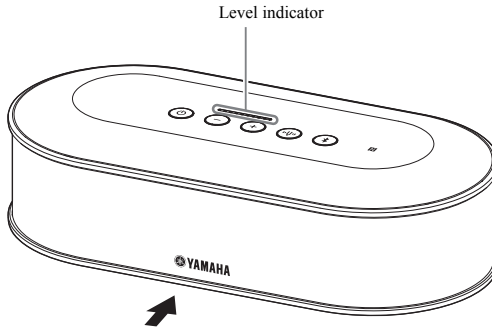

The table below shows indicator patterns viewed from this side.

Status	Description	Indication example (● : ON, ○ : OFF)	
Normal	Indicates the input level of an incoming audio signal from the remote location or external microphones (if amplifying sound from external microphones in your location is enabled).	○ ○ ○ ○ ○ ○ ○ ○ ○ ○	No audio signal is input.
		● ● ● ● ● ○ ○ ○ ○ ○	The audio signal is input.
		● ● ● ● ● ● ● ● ● ●	The audio signal input level is maximum.
When the speaker volume is adjusted (→ page 32)	Indicates the specified speaker volume.	○ ○ ○ ○ ○ ○ ○ ○ ○ ○	The speaker volume is set to the lowest level.
		● ● ● ● ● ○ ○ ○ ○ ○	The speaker volume is set to the medium level.
		● ● ● ● ● ● ● ● ● ●	The speaker volume is set to the highest level.
When the output speaker is selected (→ page 31)	Indicates output settings of the built-in speakers or external speakers.	○ ● ● ○ ○ ○ ○ ○ ○ ○ ○	The sound is output only from the built-in speakers.
		○ ● ● ○ ○ ○ ○ ● ● ○ ○	The sound is output from both the built-in speakers and external speakers.
		○ ○ ○ ○ ○ ○ ○ ○ ● ● ○ ○	The sound is output only from external speakers.

■ Rear

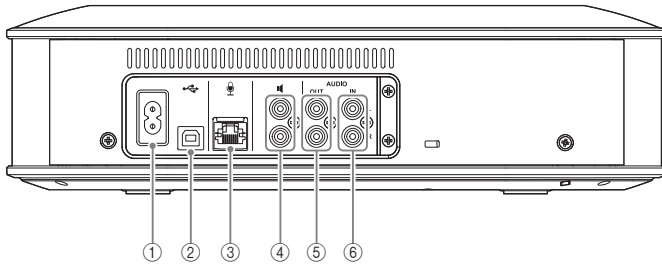

① Power terminal

Used to connect the supplied power cable.

② USB port

Used to connect the product to a PC or a Mac using the supplied USB cable.

③ Microphone terminal

Used to connect the supplied microphone using the microphone cable.

④ External speaker terminals

Used to connect the speakers to the built-in amplifier.

⑤ Audio output terminals (AUDIO OUT)

Used to connect to the audio input terminals of a video conference system.

⑥ Audio input terminals (AUDIO IN)

Used to connect to the audio output terminals of a video conference system.

External microphones can also be connected to the product by configuring a setting using the "YVC-1000 Configurator" application. (→ page 26)

■ Bottom

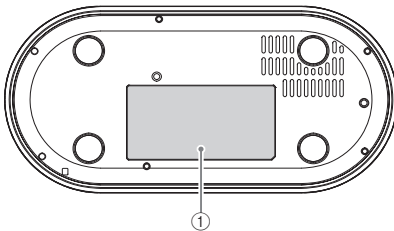

① Name plate

Provides the following information.

Model No.: Model number of the product

SERIAL LABEL: Serial number of the product

Microphone (YVC-MIC1000)

■ Top

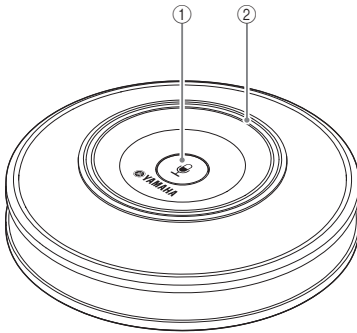

① Microphone mute button ()

Press to temporarily turn off (mute) the microphone. To cancel the mute function, press it again.

② Microphone status indicator

Lights up green when the microphone is active. Flashes red when the microphone is set to mute.

When the microphone is active, this indicator lights up brightly if sounds are input.

■ Side

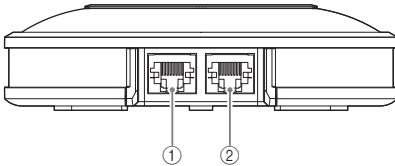

① Input terminal (IN)

Connects the optional microphone (YVC-MIC1000EX) using the microphone cable.

② Output terminal (OUT)

Connects the Control Unit using the microphone cable.

■ Bottom

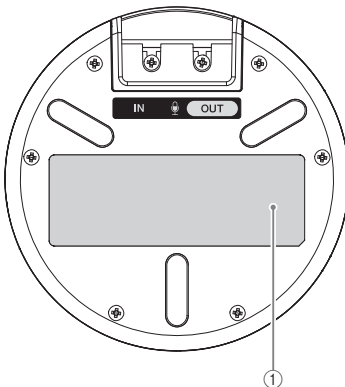

① Name plate

Provides the following information.

Model No.: Model number of the product

SERIAL LABEL: Serial number of the product

Setting up for use

Installation

Place the product in a location you will actually use it in, for example, a conference room.

■ Notes on installation

- Place the microphone at least 1 m (3.3 ft) away from the Control Unit. If the Control Unit is too close to the microphone, it may cause an echo phenomenon in the remote location.
- Keep the microphone away from any noise sources. If the noise source such as the heat radiation fan of a PC/Mac or a projector is close to the microphone, it may cause a reduction of the audio quality in the remote location.

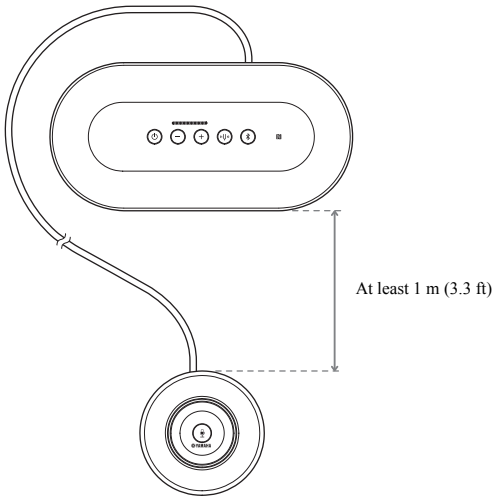

Connecting the microphone and power cables

Connect the microphone and power cables supplied with the product.

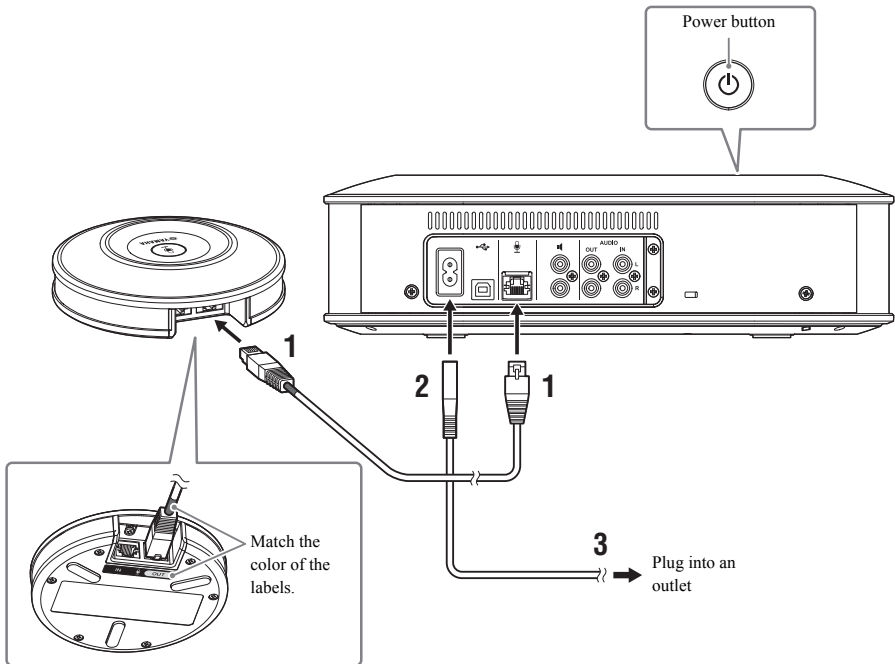

1 Connect the microphone to the Control Unit using the microphone cable supplied with the product.

2 Connect the power cable to the power terminal of the Control Unit.

3 Connect the power plug to an outlet.

The product enters the standby mode, and the power button (⏻) lights up red.

Notes

- When connecting the microphone cable, be sure to match the color of the labels on the microphone cable and of the microphone output terminal (OUT).
- Be sure to fully plug the power cable into the power terminal of the Control Unit and the outlet.

Adding microphones and speakers

If the product is used in an arrangement or in a conference with many participants where the product alone will not be sufficient, connect two or more microphones and external speakers. For details, refer to "Using the optional microphone (YVC-MIC1000EX)" (page 25) and "Using external speakers" (page 27).

The product also allows you to amplify the sound from connected external microphones, such as handheld microphones, in your location while having a conversation with the remote location. For details, refer to "Using external microphones" (page 26).

Setup

Set the product up to make best use of it.

■ Turning the power on

Press the power button (⏻) of the product to turn the power on.

When the power is turned on, all the buttons light up green.

■ Selecting the voice guidance language

The voice guidance language is set to English in the factory settings. Switch the language as necessary.

For details, refer to "Changing voice guidance settings" (page 30).

■ Selecting the speaker

Select the speaker output that suits your environment.

For details, refer to "Selecting a speaker" (page 31).

■ Adjusting the speaker volume

Adjust the speaker volume that suits your environment.

For details, refer to "Adjusting the speaker volume" (page 32).

■ Carrying out automatic audio tuning

Carry out automatic audio tuning to ensure the optimal acoustic settings to suit the environment the product is used in.

For details, refer to "Using the automatic audio tuning function" (page 28).

Connecting to communication equipment

This section describes how to connect each communication device.
After connecting them, check whether or not sounds are output normally.

Connecting to a PC using the USB cable

■ Before connecting, check the following.

Prepare the USB cable supplied with the product.

The following system environment is required in the PC to be connected to the product.

- OS: Windows (*1)
- USB: USB 2.0 or later

(*1) For the supported versions, refer to the following website:

<http://www.yamaha.com/products/en/communication/>

Notes

- It is not possible to connect and use more than one microphone or speaker including the product to one PC at the same time.
- Do not use a cable other than the USB cable supplied with the product. If a different USB cable is used, it may cause operational problems.
- The product must be connected directly to a PC. If the product is connected to a PC via a USB hub, it may cause operational problems.
- In rare cases, the audio playback may be interrupted due to PC conditions such as the workload or limited free space in memory.

■ Connection

Connect the product to a PC using the supplied USB cable.

Before connecting them, set the product to the standby mode.

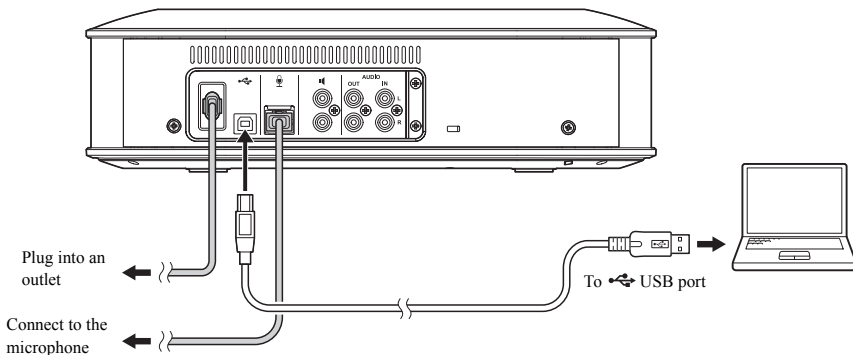

You do not need to install the USB driver separately because the product is recognized as a basic USB audio device by the PC.

■ Checking whether the connection is made normally

After the connection has been completed, execute the following steps to check that the product is normally recognized by the PC.

Note

The items and other options shown in the setting window vary depending on your PC environment.

1 Press the power button (⏻) to turn the product on.

When the power is turned on, all the buttons light up green.

2 Display the control panel.

- In Windows 7, click "Start" - "Control Panel".
- In Windows 8.1/10, right-click at the lower-left end of the Start screen, then click "Control Panel".

3 Click "Hardware and Sound" - "Sound".

The "Sound" window appears.

4 Click the "Playback" tab.

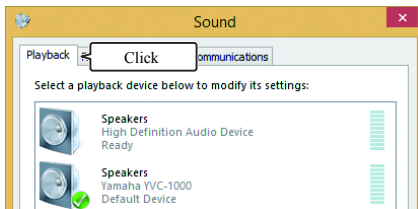

5 Check that "Yamaha YVC-1000" in the Speakers field is set to the default device.

If it is not set to the default device, click "Yamaha YVC-1000", and click "Set Default".

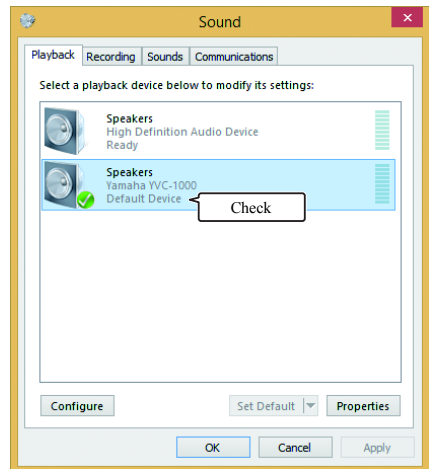

Normally, when a connection is made, "Yamaha YVC-1000" is automatically set to the default device.

6 Click the "Recording" tab.

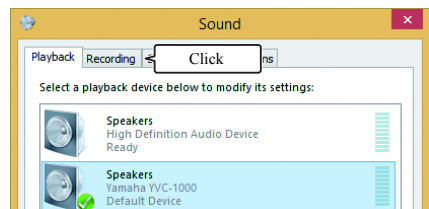

7 Check that "Yamaha YVC-1000" in the Microphone field is set to the default device.

If it is not set to the default device, click "Yamaha YVC-1000", and click "Set Default".

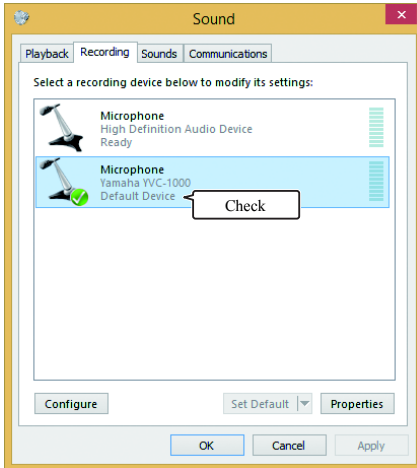

Normally, when a connection is made, "Yamaha YVC-1000" is automatically set to the default device.

8 Click "OK" to close the "Sound" window.

■ Adjusting the microphone sensitivity

The sound may crack or become faint in the remote location depending on your environment. In this case, adjust the microphone sensitivity.

Note

The items and other options shown in the setting window vary depending on your PC environment.

1 Display the control panel.

- In Windows 7, click "Start" - "Control Panel".
- In Windows 8.1/10, right-click at the lower-left end of the Start screen, then click "Control Panel".

2 Click "Hardware and Sound" - "Sound".

The "Sound" window appears.

3 Click the "Recording" tab.

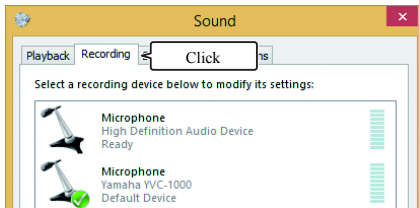

4 Select "Yamaha YVC-1000" in the Microphone field, and click "Properties".

The "Microphone Properties" window appears.

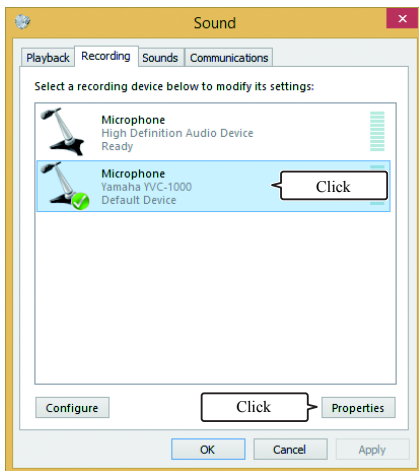

5 Click the "Levels" tab.

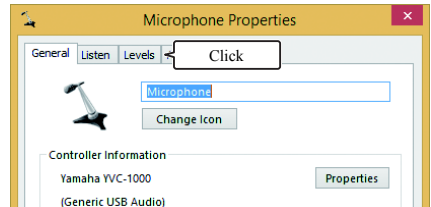

6 In the "Microphone" field, adjust the microphone sensitivity.

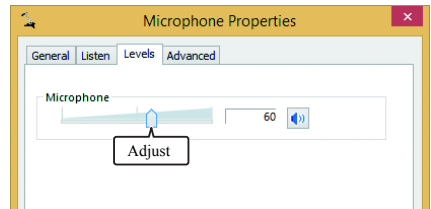

Connecting to a Mac using the USB cable

■ Before connecting, check the following.

Prepare the USB cable supplied with the product.

The following system environment is required in the Mac to be connected to the product.

- OS: macOS (*1)
- USB: USB 2.0 or later

(*1) For the supported versions, refer to the following website:

<http://www.yamaha.com/products/en/communication/>

Notes

- It is not possible to connect and use more than one microphone or speaker including the product to one Mac at the same time.
- Do not use a cable other than the USB cable supplied with the product. If a different USB cable is used, it may cause operational problems.
- The product must be connected directly to a Mac. If the product is connected to a Mac via a USB hub, it may cause operational problems.
- In rare cases, an audio playback may be interrupted due to Mac conditions such as the workload or the free space in memory.

■ Connection

Connect the product to a Mac using the supplied USB cable.

Before connecting them, set the product to the standby mode.

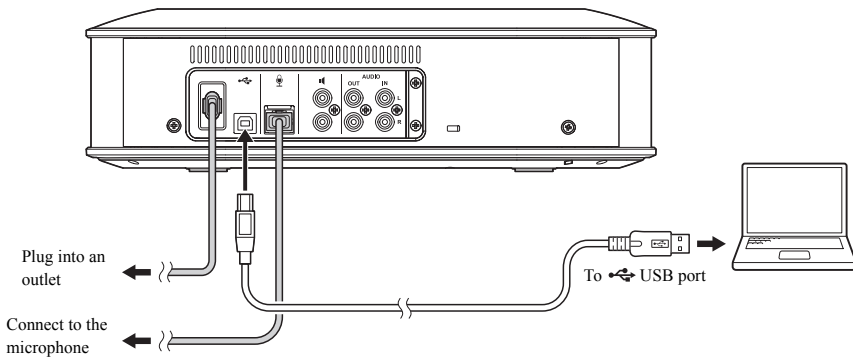

You do not need to install the USB driver separately because the product is recognized as a basic USB audio device by the Mac.

■ Checking whether the connection is made normally

After the connection has been completed, execute the following steps to check that the product is normally recognized by the Mac.

Note

The items and other options shown in the setting window vary depending on your Mac environment.

1 Press the power button () to turn the product on.

When the power is turned on, all the buttons light up green.

2 Click on the upper left of the Mac screen, and click "System Preferences".

3 Click "Sound".

The "Sound" window appears.



4 Click the "Output" tab.

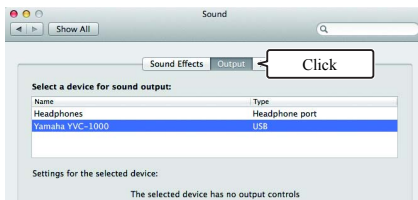

5 Check that "Yamaha YVC-1000" is selected in the "Select a device for sound output:" field.

If "Yamaha YVC-1000" is not selected, click on it.

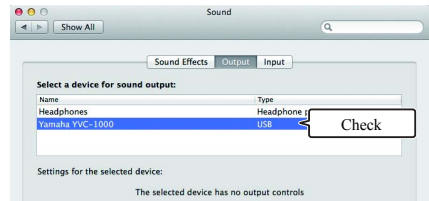

Normally, "Yamaha YVC-1000" is automatically selected when the product is connected to the Mac.

6 Click the "Input" tab.

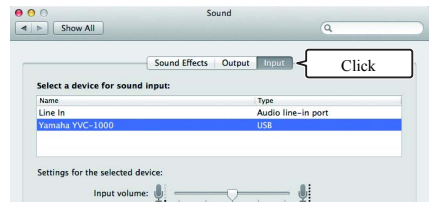

7 Check that "Yamaha YVC-1000" is selected in the "Select a device for sound input:" field.

If "Yamaha YVC-1000" is not selected, click on it.

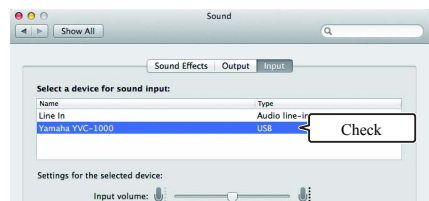

Normally, "Yamaha YVC-1000" is automatically selected when the product is connected to the Mac.

■ Adjusting the microphone sensitivity

The sound may crack or become faint in the remote location depending on your environment. In this case, adjust the microphone sensitivity.

Note

The items and other options shown in the setting window vary depending on your Mac environment.

1 From  on the upper left of the Mac screen, select "System Preferences" - "Sound" - "Input" tab.

2 In the "Input volume" field, adjust the microphone sensitivity.

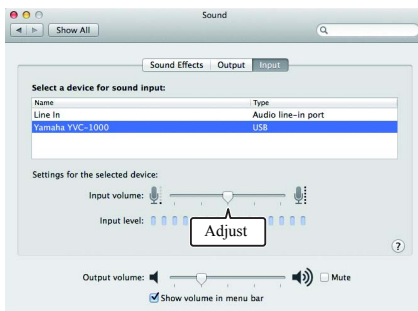

Connecting to a smartphone or tablet via Bluetooth

■ Before connecting, check the following.

Prepare a Bluetooth-compatible smartphone or tablet (hereinafter, referred to as a "smartphone").

Notes

- The distance between the smartphone and the product must be within 10 m (32.8 ft) (with no obstacles between them).
- Yamaha does not ensure all Bluetooth connections between the product and smartphones.



- The product is displayed as "YVC-1000 Yamaha" on the display of the smartphone.
- Only one smartphone can be connected to the product using Bluetooth.

■ Pairing

Pairing is an operation to register a smartphone in the product. When a Bluetooth connection is made for the first time or when pairing information is deleted, pairing is required.

Once pairing is performed, you can make a Bluetooth connection in a simple procedure.



- Check that pairing is completed on the smartphone. If pairing is not succeeded, retry pairing.
- If the power supply to the product is stopped during pairing operation, pairing information may be discarded. In this case, retry pairing.
- The product can be paired with up to eight smartphones. If pairing with the ninth smartphone succeeds, it deletes pairing information of the smartphone with the oldest date and time when a Bluetooth connection was established.
- If the product is connected to another smartphone using Bluetooth, disconnect from the smartphone before pairing.

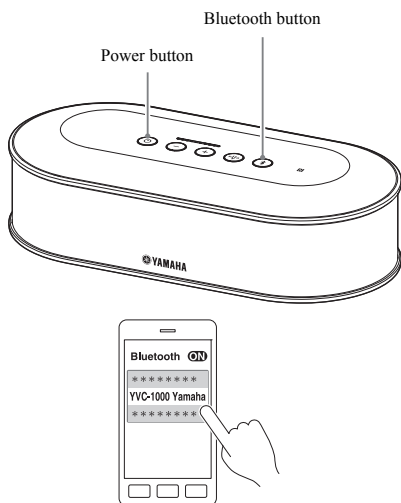

1 Press the power button (⏻) to turn the product on.

When the power is turned on, all the buttons light up green.

2 Press the Bluetooth button (Ⓜ).

The Bluetooth button (Ⓜ) flashes blue.

3 Hold down the Bluetooth button (Ⓜ) for 2 seconds or more.

The Bluetooth button (Ⓜ) flashes blue at high speed, and pairing is enabled.

4 Carry out pairing operation on the smartphone.

If a message prompts you to enter your passkey, enter "0000" in figures.



If the Bluetooth button (Ⓜ) is pressed while the Bluetooth button (Ⓜ) is flashing blue at high speed or if 90 seconds has elapsed while pairing remains uncompleted, the pairing enable status is canceled.

■ Making a Bluetooth connection with the paired smartphone



A Bluetooth connection is made simultaneously with pairing depending on smartphones. In such a case, this procedure is not required.

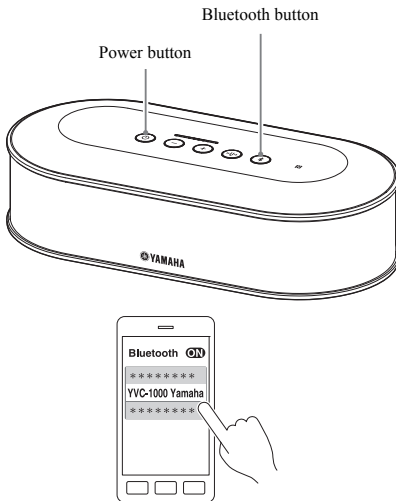

1 Press the power button (⏻) to turn the product on.

When the power is turned on, all the buttons light up green.

2 Press the Bluetooth button (Ⓜ).

The Bluetooth button (Ⓜ) flashes blue, and the Bluetooth connection is enabled.

3 Make a Bluetooth connection on the paired smartphone.

When the connection is completed, the button lights up blue.

Also, the voice guidance notifies the user that a Bluetooth connection has succeeded.



If the Bluetooth button (Ⓜ) is pressed while the Bluetooth button (Ⓜ) is flashing blue or if 90 seconds has elapsed while a Bluetooth connection remains uncompleted, the Bluetooth enable status is canceled.

■ Pairing and Bluetooth connection using the NFC function (for NFC-compatible model)

If the smartphone satisfies the following conditions (hereinafter, referred to as an "NFC-compatible model"), pairing and Bluetooth connection operations can be performed easily.

- NFC-compatible Android devices

Before starting this procedure, turn the NFC function on in the smartphone.

Note

This function may not work or the connectable distance may be different depending on smartphones.



- If the smartphone is covered with a case, remove the case.
- If pairing or Bluetooth connection has failed, change the position of where to pass the smartphone over the product.

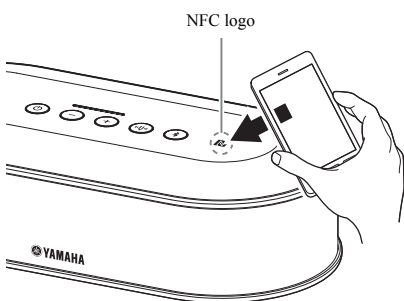

1 Press the power button (⏻) to turn the product on.

When the power is turned on, all the buttons light up green.

2 Press the Bluetooth button (Ⓜ).

The Bluetooth button (Ⓜ) flashes blue, and the Bluetooth connection is enabled.

3 Pass the smartphone over the NFC logo of the product.

When the connection is completed, the button lights up blue.

Also, the voice guidance notifies the user that a Bluetooth connection has succeeded.



If the Bluetooth button (Ⓜ) is pressed while the Bluetooth button (Ⓜ) is flashing blue or if 90 seconds has elapsed while a Bluetooth connection remains uncompleted, the Bluetooth enable status is canceled.

■ Terminating a Bluetooth connection

If one of the following operations is performed while a Bluetooth connection is made, a Bluetooth connection is terminated.

- Press the Bluetooth button (Ⓜ).
- Perform the Bluetooth disconnection procedure on the smartphone.
- Pass the smartphone over the NFC logo of the product (for an NFC-compatible model).

When a Bluetooth connection is terminated, the Bluetooth button (Ⓜ) lights up green.

Also, the voice guidance notifies the user that a Bluetooth connection has been terminated.



When the product is placed into the standby mode, a Bluetooth connection is also terminated.

Connecting to a video conference system using audio cables

■ Before connecting, check the following.

Prepare two audio cables (stereo RCA pin plug) for input and output.



The video conference system may provide different shapes of audio input and output terminals depending on the model. Use audio cables with the plug shapes that match the shapes of the audio input and output terminals for your video conference system. The product must be connected to a stereo RCA pin plug regardless of the type of the plug to be connected to the video conference system.

■ Connection

Connect the product to the video conference system using audio cables.

Before connecting them, set the product to the standby mode.

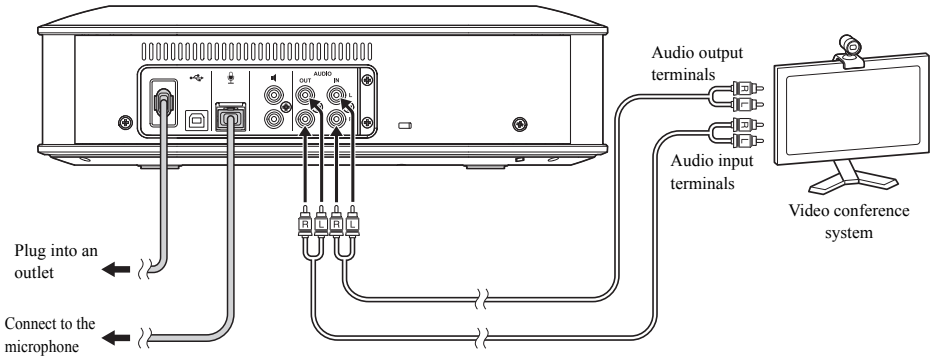

■ Changing settings for the video conference system

Change the sound input/output settings so that the product is used as a microphone and speaker of the video conference system.

Note

Be sure to disable the microphone and speaker on the video conference system side.

■ Setting with "YVC-1000 Configurator"

When using the video conference system, connect the product to a PC or a Mac on which the "YVC-1000 Configurator" application has been downloaded, and set the device to be connected to the audio input terminals to the video conference system.

For details, refer to "When the video conference system is connected:" (page 37).

The sound may crack or become faint in the remote location depending on your environment. In this case, adjust the audio output volume using the "YVC-1000 Configurator" application.

For details, refer to "Adjusting the audio output volume" (page 39).



- The device to be connected to the audio input terminals is set to the video conference system in the factory settings.
- The settings configured with "YVC-1000 Configurator" are saved in the product, therefore it is not necessary to keep the PC or Mac connected after the settings have been completed. The configured settings continue to be saved even after the product has been turned off.

Using Convenient Functions

This section describes convenient functions provided by the product.

Using the optional microphone (YVC-MIC1000EX)

Up to five microphones, including the supplied microphone and optional microphone (YVC-MIC1000EX), can be connected to the product. When using the product in a layout or a multi-participant conference that cannot be covered by only one microphone, use multiple microphones to extend the area where sounds can be picked up.

■ Installation

Place all microphones 1 m to 20 m (3.3 ft to 66 ft) away from the Control Unit.

The following figure shows an example of five microphones installed in a line.

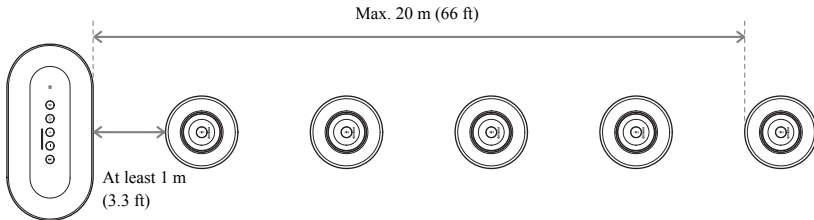

Note

If the Control Unit is too close to microphones, it may cause an echo phenomenon in the remote location.

■ Connection

Connect multiple microphones using microphone cables.

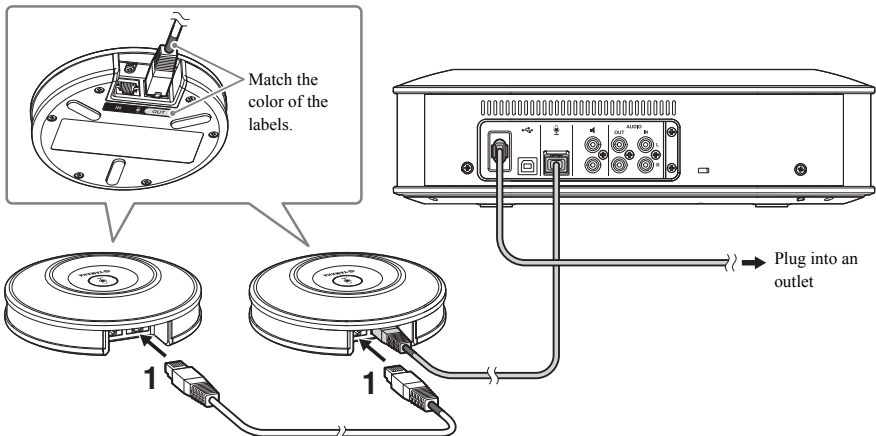

1 Connect the second microphone to the first microphone.

2 If necessary, connect the third microphone and the subsequent ones with each other.

Note

When connecting microphones, be sure to match the color of the labels on the microphone cable and of the microphone output terminal (OUT).

Using external microphones

Up to two external microphones such as a handheld microphone or pin microphone can be connected to the product. If you want to amplify the sound in your location when having a conversation with the remote location, connect an external microphone.



A wireless handheld microphone or wireless pin microphone can also be used.

■ Preparation

To connect an external microphone, use a microphone with a cable that has an RCA pin plug that can be connected to the YVC-1000.

■ Connection

The following example shows a case in which one handheld microphone is connected to the product. An external microphone can be used together with the microphone supplied with the product, or an optional microphone (YVC-MIC1000EX).

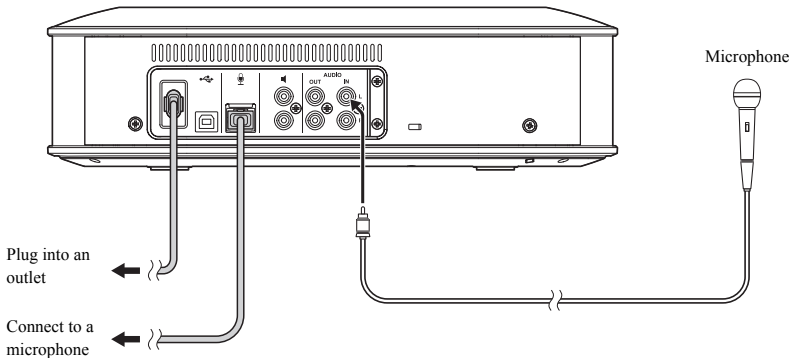

- The sound picked up by external microphones is output not only in the remote location but also from the built-in speaker. When external speakers are used, the sound is also output from them.
- The video conference system can be connected to an audio input terminal that has no external microphone connected to it. For details, refer to "Connecting to a video conference system using audio cables" (page 23).

■ Setting with "YVC-1000 Configurator"

When using external microphones, connect the product to a PC or a Mac on which the "YVC-1000 Configurator" application has been downloaded, to enable the external microphones. Also, adjust the volume or tone to suit the type of external microphone you are using, or your environment.

For details, refer to "When external microphones are connected:" (page 37).

Note

If you hear any feedback, place the external microphones away from the speakers, or reduce the sensitivity of the external microphones using "YVC-1000 Configurator".



The settings configured with "YVC-1000 Configurator" are saved in the product, therefore it is not necessary to keep the PC or Mac connected after the settings have been completed. The configured settings continue to be saved even after the product has been turned off.

Using external speakers

Up to two speakers with built-in amplifiers can be connected to the product as external speakers. When using the product in a layout or a multi-participant conference that cannot be covered by only the built-in speaker, use external speakers to extend the area where playback sounds can be heard.

Note

Use external speakers with a low latency and distortion.

If you use external speakers with a high latency or distortion, it may cause an echo phenomenon in the remote location.

Preparation

Prepare audio cables (RCA pin plug) to suit the number of external speakers to be connected.



- Speakers with a built-in amplifier may have a different shape of the audio input terminal depending on the model. Use an audio cable with the plug shape that matches the shape of the audio input terminal for each of your speakers. The product must be connected to an RCA pin plug regardless of the type of the plug to be connected to each speaker.
- Monaural signal is output as an audio signal from both external speaker terminals.

Installation

Place all external speakers 1 m to 20 m (3.3 ft to 66 ft) away from all microphones.

The following figure shows an example of installation of two external speakers and one microphone.

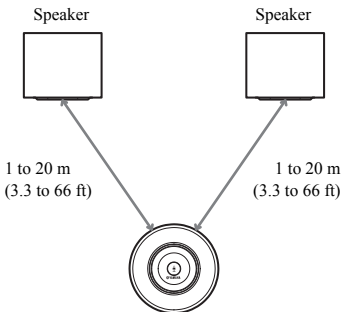

Note

If external speakers are too close to or far from microphones, it may cause an echo phenomenon in the remote location.

Connection

Connect the product to external speakers using audio cables.

The following example shows a case in which two external speakers are connected.

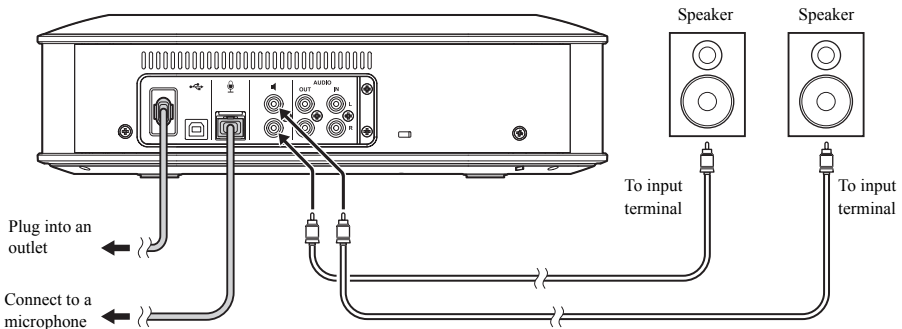

Note

Do not connect external speakers to the audio output terminals.

Using the automatic audio tuning function

The automatic audio tuning function automatically measures acoustic features of the location the product is installed in as well as acoustic conditions such as positions to place the microphone and speaker, and tunes the acoustic settings to the optimal level to suit the environment the product is used in.

If you have changed the installation location or installation position of the product, or if you have changed the number of microphones or connected an external speaker, be sure to carry out automatic audio tuning before using the product.



The result of automatic audio tuning continues to be saved even after the power has been turned off.

■ Preparation

Make the following preparation to normally carry out the automatic audio tuning.

- Place the Control Unit, microphones, and external speakers (if used) as used actually, and make connections.
- Adjust the speaker volume so that four or more lamps light up on the level indicator.

■ Carrying out automatic audio tuning

While automatic audio tuning is active, the voice guidance is replayed to explain the procedure for carrying out automatic audio tuning.

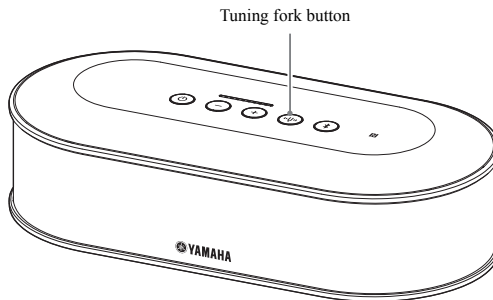

1 Hold down the tuning fork button () for 2 seconds or more.

The tuning fork button () flashes orange, and automatic audio tuning starts.

2 The acoustic measurement starts.

A white noise (hissing sound) is replayed from speakers as the measurement sound. During measurement, stay away from the devices and keep quiet.

3 The acoustic settings starts.

This carries out the optimization of adaptive echo canceller settings and automatic room EQ settings, the latency compensation of external speakers, and the calibration of frequency characteristics.

Note

If "MODE" is set to "PA MICROPHONE" using "YVC-1000 Configurator", the latency compensation of external speakers will not be enabled.

4 Automatic audio tuning ends.

When automatic audio tuning ends, the result is notified using the voice guidance.

Also, the result is indicated by the color and lit/not lit status of the tuning fork button ().

Each indicator status has the following meaning.

- Lit (Green): Normal end
- High-speed flash (Orange): Abnormal end



- Automatic audio tuning cannot be started in the following cases.

- The speaker volume is low (three or less lamps light up on the level indicator).
- No microphone is connected.

- If the following operation or status is detected during the acoustic measurement, automatic audio tuning is stopped.

- The tuning fork button () has been pressed.
- When the product is connected to a PC or a Mac using a USB cable, the speaker volume has been operated through a PC or a Mac.
- A microphone cable has been unplugged.
- When only external speakers are enabled, no sound is output from them.

■ When automatic audio tuning has ended abnormally (problem detection)

When automatic audio tuning has ended abnormally (problem detection), the tuning fork button (🔊) flashes orange at high speed. Check the detected problems using the voice guidance, and take the appropriate action, referring to "Warning guidance list" (page 44).

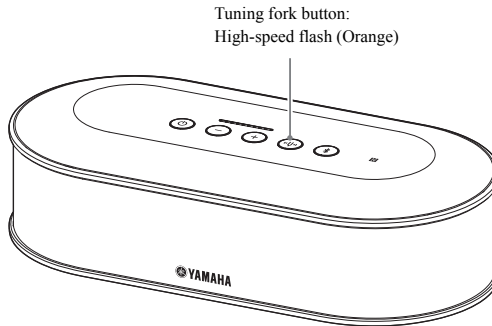

1 Press the tuning fork button (🔊) while it is flashing orange at high speed.

The voice guidance notifies the user about the detected problem three times at 5-second intervals.

2 The voice guidance notifies the user about the next problem one minute after the playback of the first problem has been completed.

After the playback of all the problems is completed, the tuning fork button (🔊) lights up green, and the product returns to the normal mode.



- If the tuning fork button (🔊) is not pressed for 5 minutes while it is flashing orange at high speed, the tuning fork button (🔊) lights up green, and the product returns to the normal mode.
- If the tuning fork button (🔊) is pressed during guidance playback, the product works as shown below depending on guidance conditions.
 - When a problem is replayed: The playback is stopped, and the product enters the standby mode (1 minute) to replay the next problem.
 - When a problem is not replayed: The playback of the next problem starts immediately.

■ Detecting acoustic conditions in general use

If any problem is detected in acoustic conditions in general use, the tuning fork button (🔊) lights up or flashes orange. Check the detected problems using the voice guidance, and take the appropriate action, referring to "Warning guidance list" (page 44).

While the button is lit or flashing orange, press the tuning fork button (🔊).

The voice guidance notifies the user about the detected problem.

When the voice guidance ends, the tuning fork button (🔊) lights up green.



If the tuning fork button (🔊) is pressed during guidance playback, the playback is stopped, and the tuning fork button (🔊) lights up green.

Changing voice guidance settings

Notify results of operations such as a Bluetooth connection, problems in acoustic conditions, or the automatic audio tuning procedure using the voice guidance.

The voice guidance can be enabled or disabled, and its language can be switched as necessary. The voice guidance language is set to English in the factory settings. Switch the language as necessary.

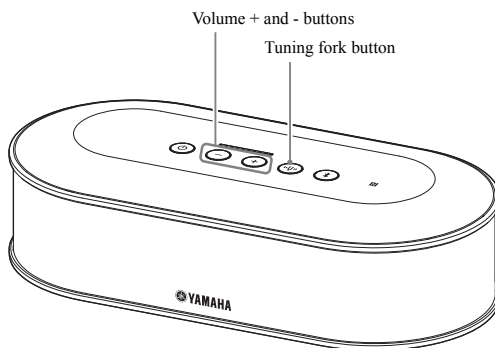

Switching the voice guidance language

When the voice guidance is enabled, repeatedly press the volume + button (⊕) while holding down the tuning fork button (🔊).

Each time the volume + button (⊕) is pressed, the language is switched as shown below.

English → Japanese → Chinese → Korean → French → Spanish → German

↑

The voice guidance notifies the user about the name of the selected language.

Disabling voice guidance

When the voice guidance is enabled, press the volume - button (⊖) while holding down the tuning fork button (🔊). The voice guidance notifies the user that the voice guidance has been disabled.

Enabling the voice guidance

When the voice guidance is disabled, press the volume + button (⊕) while holding down the tuning fork button (🔊).

The voice guidance notifies the user that the voice guidance has been enabled.

Selecting a speaker

Select whether to output the incoming sound through only the built-in speaker, only external speakers, or both the built-in speaker and external speakers.

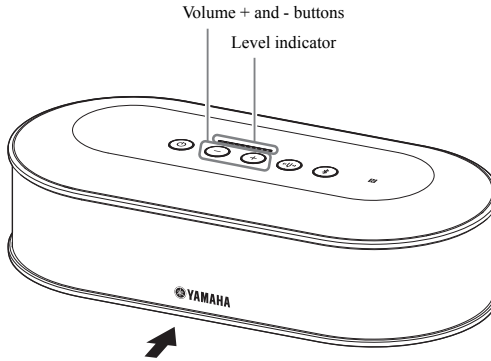

The table below shows indicator patterns viewed from this side.

1 Hold down the volume + and - buttons (\oplus \ominus) for 2 seconds or more at the same time.

The volume + and - buttons (\oplus \ominus) flash green.

The selected speaker is shown on the level indicator, and the voice guidance prompts you to determine the speaker.

Indicator pattern (● : ON, ○ : OFF)	Speaker output
○●●○○○○○○○○	The sound is output only from the built-in speakers.
○●●○○○○●●○○	The sound is output from both the built-in speakers and external speakers.
○○○○○○○○●●○○	The sound is output only from external speakers.

2 Press the volume + (\oplus) button or volume - (\ominus) button to change the required speaker.

If the speaker is changed, the voice guidance notifies the user of information about the new speaker.

If the volume + (\oplus) button or volume - (\ominus) button is not pressed for 6 seconds or more, the product returns to the normal mode.

Operation	Changed contents
Press the volume + button (\oplus).	Switches whether to enable or disable the output of external speakers.
Press the volume - button (\ominus).	Switches whether to enable or disable the output of the built-in speaker.



Both the built-in speaker and external speakers cannot be disabled.

Adjusting the speaker volume

When external speakers are not connected or only the built-in speaker is enabled, press the volume + and - buttons (⊕ ⊖) to adjust the volume.

If external speakers are enabled, perform the following procedure to suit the environment they are used in.

■ When both the built-in speaker and external speakers are enabled:

1. Set the volume of external speakers to the minimum.
2. Press the volume + and - buttons (⊕ ⊖) to adjust the volume of the built-in speaker.
3. Adjust the volume of external speakers.

■ When only external speakers are enabled:

First, take steps 1 to 3 described below to fix the volume of the external speakers. Then, use the volume + and - buttons (⊕ ⊖) of the product to adjust the volume when you are using the product.

1. Set the volume of external speakers to the minimum.
2. Press the volume + button (⊕) to set the volume to the maximum.
3. Adjust the volume of the external speakers to the maximum level available during use.
4. Press the volume + and - (⊕ ⊖) buttons to adjust the volume to the desired level.

Note

When adjusting the speaker volume, be careful to cause no sound cracking. Sound cracking may cause an echo phenomenon in the remote location.



If you operate the volume + and - buttons (⊕ ⊖) of the Control Unit, you can adjust the volume of both the built-in speaker and external speakers.

If a PC or a Mac is connected using the USB cable, its speaker volume is adjusted synchronously.

Muting the microphone

Temporarily stop the microphone so that the other party does not hear a voice in this side.

■ Muting the microphone

Press the microphone mute button (⊕).

The microphone status indicator flashes red, and microphone muting starts.

■ Canceling microphone muting

Press the microphone mute button (⊕) during microphone muting.

The microphone status indicator lights up green, and microphone muting is canceled.



The microphone muting function is synchronized with all microphones. If one microphone is muted while multiple microphones are connected, all of them are muted.

Note

Even if this function is enabled, external microphones will not be muted.

Muting the speaker

Temporarily mute the speaker so that incoming sounds cannot be heard.

This function is available only when a PC or a Mac is connected using the USB cable.

■ Muting the speaker

Mute the speaker on a PC or Mac.

The volume + and - buttons (⊕ ⊖) flash green, and the speaker is muted.

■ Unmuting the speaker

Unmute the speaker on a PC or Mac that has been muted.

The volume + and - buttons (⊕ ⊖) light up green, and the speaker is unmuted.



The speaker can also be unmuted by pressing the volume + and - buttons (⊕ ⊖).

Enabling or disabling the Bluetooth function

When not using a Bluetooth connection, you can disable the Bluetooth function. To use a Bluetooth connection again, enable the Bluetooth function.

■ Disabling the Bluetooth function

- 1 When the power is on (the power button (⏻) lights up green), press and hold the power button (⏻) for 2 seconds or more to enter standby mode.**

The product enters the standby mode, and the power button (⏻) lights up red.

- 2 Press the power button (⏻) while holding down the Bluetooth button (Ⓜ) and the volume - button (⏮) at the same time, then release the power button (⏻) only.**

The lamps on the level indicator will light up moving horizontally, and the power-on operation starts. Be sure to hold down the Bluetooth button (Ⓜ) and the volume - button (⏮).

- 3 When the Bluetooth function is disabled, you will be notified by voice guidance. When the level indicator is turned off, release the Bluetooth button (Ⓜ) and the volume - button (⏮).**

Check whether the Bluetooth button (Ⓜ) is not lit.

■ Enabling the Bluetooth function

- 1 When the power is on (the power button (⏻) lights up green), press and hold the power button (⏻) for 2 seconds or more to enter standby mode.**

The product enters the standby mode, and the power button (⏻) lights up red.

- 2 Press the power button (⏻) while holding down the Bluetooth button (Ⓜ), then release the power button (⏻) only.**

The lamps on the level indicator will light up moving horizontally, and the power-on operation starts. Be sure to hold down the Bluetooth button (Ⓜ).

- 3 When the Bluetooth function is enabled, you will be notified by voice guidance. When the level indicator is turned off, release the Bluetooth button (Ⓜ).**

Check whether the Bluetooth button (Ⓜ) is lit.

Returning to the factory settings

Return the settings of the product to the factory settings.

- 1 When the power is on (the power button (⏻) lights up green), press and hold the power button (⏻) for 2 seconds or more to enter standby mode.**

The product enters the standby mode, and the power button (⏻) lights up red.

- 2 Press the power button (⏻) while holding down the tuning fork button (🔑) and the volume - button (⏮) at the same time, then release the power button (⏻) only.**

The lamps on the level indicator will light up moving horizontally, and the power-on operation starts. Be sure to hold down the tuning fork button (🔑) and the volume - button (⏮).

- 3 When various settings are reset to their factory defaults, you will be notified by English voice guidance. When the level indicator is turned off, release the tuning fork button (🔑) and the volume - button (⏮).**



- Even if the voice guidance is disabled before returning to factory settings, the voice guidance will notify the user in English when the settings of the product are returned to factory settings.
- When the settings are returned to the factory settings, Bluetooth pairing information is also erased. Refer to "Setup" (page 12) and the subsequent sections to set the product up again.

Using the YVC-1000 Configurator

Using the "YVC-1000 Configurator" application allows you to configure various settings for the input and output terminals that cannot be carried out using buttons on the product.



This manual provides a description based on the "YVC-1000 Configurator" screens and the operations on the PC.

Downloading

Download this application from the download page on our website.

■ Download page

<http://www.yamaha.com/products/en/communication/download/>

■ Download file

Download the following file.

"XXX" in the file name indicates the version of YVC-1000 Configurator.

- For PCs:
YVC-1000_Configurator_XXX.zip
- For Macs:
YVC-1000_Configurator_XXX.dmg

Note

To use "YVC-1000 Configurator", the firmware version of the product must be 2.00 or later. The latest firmware version can be downloaded from the download page shown above.

■ Decompressing the downloaded file

Decompress the downloaded file, and check that the following files are included in the folder. (For Macs, disk images are mounted.)

PC/Mac	File name and description
PC	YVC-1000 Configurator.exe • Application file
	Uninstaller.bat • Used for uninstallation.
Mac	YVC-1000 Configurator.app • Application file
	Uninstaller.app • Used for uninstallation.

■ Uninstallation

Application information is stored on a PC or a Mac when "YVC-1000 Configurator" is initially started. To erase the stored information, perform the uninstallation procedure shown below.

■ Uninstallation procedure

Double-click the following file in the downloaded "YVC-1000 Configurator" folder.

- For PCs: Uninstaller.bat
- For Macs: Uninstaller.app

A confirmation message appears. For PCs, press the "y" key, and then the "Enter" key using the keyboard. For Macs, click "OK".

Basic usage

This section describes the basic usage of "YVC-1000 Configurator".

1 Using the USB cable supplied with the product, connect the product to a PC or a Mac on which "YVC-1000 Configurator" has been downloaded.

2 Turn on the product and a PC or a Mac.

When the product is turned on, all the buttons light up green.

3 Double-click "YVC-1000 Configurator.exe" ("YVC-1000 Configurator.app" for Macs).

The "YVC-1000 Configurator Licensing Agreement" dialog box appears when the system is initially started. Carefully read the contents, select "Accept all terms of the license agreement", and click "OK".



The "YVC-1000 Configurator Licensing Agreement" dialog box also appears when a different version is initially started, for example, immediately after the latest version of "YVC-1000 Configurator" has been downloaded.

4 Change settings.

Change settings of the product to suit your environment.

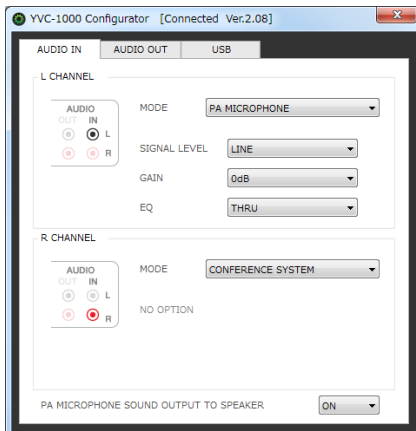

5 Exit "YVC-1000 Configurator".

- For PCs, click the button in the upper right of the "YVC-1000 Configurator" window.
- For Macs, click the button in the upper left of the "YVC-1000 Configurator" window.



The settings configured with "YVC-1000 Configurator" are saved in the product, therefore it is not necessary to keep the PC or Mac connected after the settings have been completed. The configured settings continue to be saved even after the product has been turned off.

Changing the setting of the audio input terminals

Change the setting depending on the device connected to the audio input terminals.

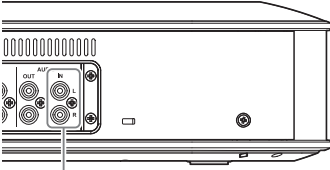

Audio input terminals

■ When the video conference system is connected:

The factory settings are compatible with the connection of the video conference system; therefore, you do not need to change them. Reconfigure the settings when connecting the video conference system in place of external microphones.

1 In the "YVC-1000 Configurator" window, select the "AUDIO IN" tab.

2 Select "CONFERENCE SYSTEM" from the "MODE" drop-down list.

Select this item for the terminal (either or both of the L and R terminals) connected to the video conference system.

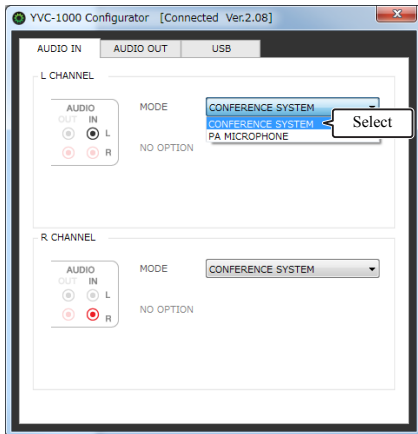

■ When external microphones are connected:

1 In the "YVC-1000 Configurator" window, select the "AUDIO IN" tab.

2 Select "PA MICROPHONE" from the "MODE" drop-down list.

Select this item for the terminal (either or both of the L and R terminals) connected to the external microphones.

After completing the setting, conduct a test to identify whether there are any problems in relation to the audio sound of the external microphones.

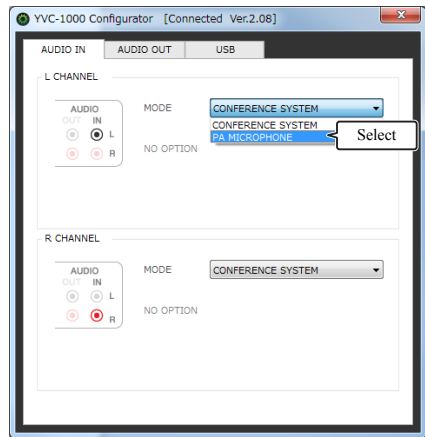

Note

If "PA MICROPHONE" is selected, the latency compensation of external speakers, which has been set by the automatic audio tuning function, will not be enabled.

3 Change the volume or tone setting to suit the type of external microphones you are using, or your environment.

Change the setting in the drop-down list.

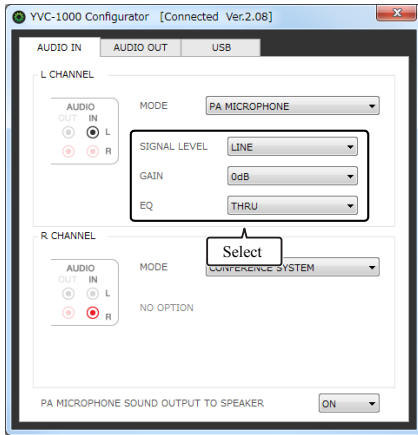

SIGNAL LEVEL:

Set the output level of the external microphones.

Setting	Description
MICROPHONE	Sets to the microphone level.
LINE	Sets to the line level.

GAIN:

Adjust the sensitivity of the external microphones. The sensitivity can be set in 3 dB steps between -12 dB (minimum) and +12 dB (maximum).

EQ:

Adjust the tone of the external microphones.

Setting	Description
THRU	Does not change the tone.
LOW CUT	Turns down the low pitch sound.
LOW BOOST	Turns up the low pitch sound.

4 Select whether to amplify the sound from the external microphones in your location.

Change the setting from the "PA MICROPHONE SOUND OUTPUT TO SPEAKER" drop-down list as necessary. This setting is applied to both the L and R terminals.

Note

If the firmware version of the product is below 2.08, the items in this setting do not appear.

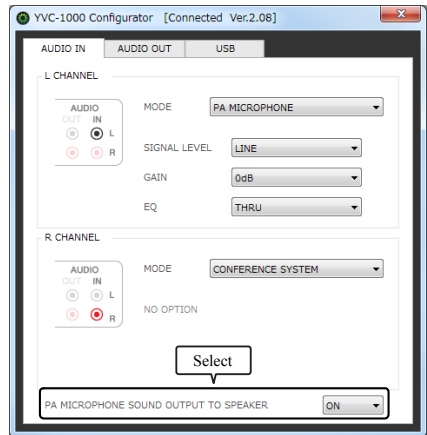

Setting	Description
ON	Enables amplifying the sound in your location.
OFF	Disables amplifying the sound in your location.

Changing the setting of the audio output terminals

Change the setting depending on the device connected to the audio output terminals.

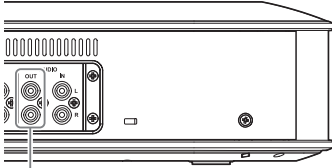

Audio output terminals

■ Adjusting the audio output volume

The sound may crack or become faint in the remote location depending on your environment. In this case, adjust the audio output volume.

1 In the "YVC-1000 Configurator" window, select the "AUDIO OUT" tab.

2 Select the volume from the "OUTPUT VOLUME" drop-down list.

The volume can be set in 3 dB steps between -12 dB (minimum) and +12 dB (maximum).

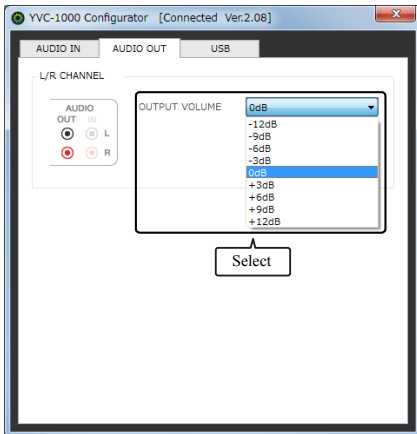

Changing the setting of the USB port

Change the setting depending on the device connected to the USB port.

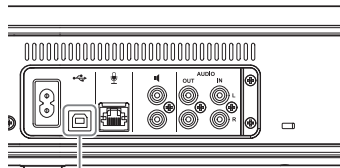

USB port

Note

If the firmware version of the product is below 2.03, you cannot change the setting of the USB port.

■ Setting the data transfer rate of the USB port

1 In the "YVC-1000 Configurator" window, select the "USB" tab.

2 Select the data transfer rate.

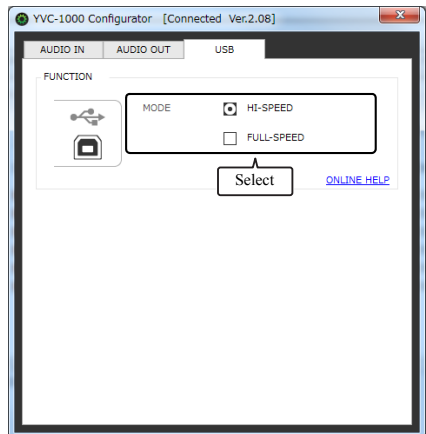

Setting	Description
HI-SPEED	Transfers data in USB 2.0 High Speed mode.
FULL-SPEED	Transfers data in USB 2.0 Full Speed mode.



Clicking "ONLINE HELP" allows you to access the support site that informs whether to select "HI-SPEED" or "FULL-SPEED" depending on the connected device.

3 A message appears to confirm whether to restart the product. Click "OK".

The product restarts. Then, the setting is changed.

Troubleshooting

Before inquiry

Referring to this manual, check whether the detected problem can be resolved. If the problem recurs, please contact the retailer or dealer who you purchased the product from.

Q1 A button or indicator is turned off or flashing

Symptom	Cause	Action
The power button (⏻) is turned off.	<ul style="list-style-type: none"> The power cable has been unplugged. The power cable is not plugged in securely. 	Securely connect the power cable to an outlet or the Control Unit. (→ page 11)
The power button (⏻) is flashing red.	The product is damaged.	Request to repair the product.
The power button (⏻) is lit up orange.	The product firmware is damaged. (The power button is flashing orange during a firmware update.)	Request to repair the product.
The Bluetooth (Ⓜ) button is not lit.	The Bluetooth function is disabled.	Enable the Bluetooth function. (→ page 33)

Q2 There is a problem with the audio quality

Symptom	Cause	Action
No incoming sounds are output from the speaker.	The speaker volume is set to the minimum.	Turn up the speaker volume. (→ page 32)
	When only the external speakers are enabled, they are not connected.	Correctly connect the external speakers. (→ page 27)
	Microphone muting is enabled in the remote location.	Disable microphone muting in the remote location.
	The microphone sensitivity in the remote location is set to the minimum.	Increase the microphone sensitivity in the remote location.
No sounds are output in the remote location.	Microphone muting is enabled.	Disable microphone muting. (→ page 32)
	If a PC or a Mac is connected using the USB cable, its microphone sensitivity is set to the minimum.	Increase the microphone sensitivity. (→ page 16, 19)
	The speaker volume in the remote location is set to the minimum.	Turn up the speaker volume in the remote location.
An echo is heard.	There is a problem with the device configuration or operating environment in the remote location.	—

Symptom	Cause	Action
An echo or feedback is heard in the remote location.	A microphone other than the product is connected to a communication device.	Select the product in the communication device settings. (→ page 14, 18)
	The Control Unit is close to or far away from the microphone.	Place all microphones 1 m to 20 m (3.3 ft to 66 ft) away from the Control Unit. (→ page 25)
	An external speaker is close to or far away from the microphone.	Place external speakers 1 m to 20 m (3.3 to 66 ft) away from all microphones. (→ page 27)
	An external speaker with a high latency or distortion is used.	Replace with an external speaker that has a low latency or distortion.
	A microphone is placed in the wall side.	Place a microphone, avoiding the wall side.
	An object is placed near a microphone.	Do not place an object near a microphone if possible.
	The product is used in a room with a high resonance.	<ul style="list-style-type: none"> Place an object with high sound absorbability in a room, avoiding the front of the microphone. To reduce a resonance, turn down the speaker volume. (→ page 32)
Noises are heard.	There is a problem with the device configuration or operating environment in the remote location.	—
Noises are heard in the remote location.	There is a device that generates noise near a microphone.	Keep the microphone away from any noise sources.
	High noises are generated in the entire space in which the product is installed.	If there is a device that generates noise, turn its power off.
Sound cracking occurs.	The device connected to the audio input terminals is set to the high output level.	Decrease the output level of the connected device.
	The external speaker is set to the high volume.	Turn down the volume of the external speaker. (→ page 32)
	An external speaker with high distortion is used.	Replace with an external speaker that has low distortion.
	The microphone sensitivity in the remote location is high.	Reduce the microphone sensitivity in the remote location.
Sound cracking occurs in the remote location.	The microphone is set to the high input level.	Take the microphone away from a speaker.
	The device connected to the audio output terminals does not satisfy the line-level input condition.	Connect the device that satisfies the line-level input condition.
	The speaker volume in the remote location is high.	Turn down the speaker volume in the remote location.
	If a device is connected to the audio output terminals, the audio output volume is high.	Turn down the audio output volume. (→ page 39)
	If a PC or a Mac is connected using the USB cable, its microphone sensitivity is high.	Reduce the microphone sensitivity. (→ page 16, 19)

Symptom	Cause	Action
The volume in the remote location is low.	If a PC or a Mac is connected using the USB cable, its microphone sensitivity is low.	Increase the microphone sensitivity. (→ page 16, 19)
	If a device is connected to the audio output terminals, the audio output volume is low.	Turn up the audio output volume. (→ page 39)

Q3 Others

Symptom	Cause	Action
The voice guidance is not played back.	The voice guidance is disabled.	Enable the voice guidance. (→ page 30)
Cannot perform pairing with Bluetooth connection.	The smartphone to be paired has pairing information with another YVC-1000.	Delete pairing information with another YVC-1000 from the smartphone, and perform pairing with the target YVC-1000. (→ page 20)
Cannot amplify the sound in your location when using the external microphones.	Amplifying of the sound from the external microphones in your location is disabled.	Enable amplifying the sound from the external microphones in your location. (→ page 38)

Warning guidance list

When the product detects a problem related to acoustic conditions, you can confirm its details using the voice guidance.

(For details, refer to "When automatic audio tuning has ended abnormally (problem detection)" (page 29) and "Detecting acoustic conditions in general use" (page 29)).

Take the appropriate actions - outlined below - to resolve the detected problem.

Voice guidance:	Cause	Action
Please connect the microphones. Automatic audio tuning cannot start.	<ul style="list-style-type: none"> • A microphone cable has been unplugged. • A microphone cable is not connected correctly. 	Correctly connect the microphone cable to the microphone or the Control Unit. (→ page 11)
The volume is set too low. Automatic audio tuning cannot start.	The speaker volume is set low.	Turn up the speaker volume level so that four or more lamps light up on the level indicator. (→ page 32)
The external speakers are not working. Please refer to the User's manual and check the external speaker settings.	<ul style="list-style-type: none"> • An audio cable has been unplugged. • An audio cable is not connected securely. 	Securely connect audio cables to external speakers or the Control Unit. (→ page 27)
	The volume of an external speaker is low.	Turn up the volume of the external speaker. (→ page 32)
The distance between the speakers and the microphones is too close. The maximum volume is now limited.	The Control Unit or external speakers are too close to the microphones.	Place all the microphones at least 1 m (3.3 ft) away from the Control Unit or external speakers. (→ page 25, 27)
The microphones are too far from the speakers. Please refer to the User's manual.	The Control Unit is placed too far from the microphones.	Place all the microphones within 20 m (66 ft) away from the Control Unit. (→ page 25)
A latency problem has been detected on the external speakers. Please refer to the User's manual and use suitable external speakers.	A high latency has been detected on the external speakers.	Place all the external speakers within 20 m (66 ft) away from all the microphones. (→ page 27) If the problem recurs, replace with external speakers with a low latency.
A sound distortion problem has been detected on the external speakers. Please refer to the User's manual and check the external speaker settings.	The external speaker is set to the high volume.	Turn down the volume of the external speaker. (→ page 32)
	The external speakers have high distortion.	Replace with an external speaker that has low distortion.
A source of noise has been detected near the microphones. To improve the audio quality, please move the microphones or the source of noise.	There is a device that generates noise near a microphone.	Keep the microphone away from any noise sources.
The noise is exceeding the normal level. The audio quality is degraded.	High noises are generated in the entire space in which the product is installed.	If there is a device that generates noise, turn its power off.
To improve audio quality, please perform automatic audio tuning.	—	Press the tuning fork button () for 2 seconds or more to carry out automatic audio tuning. (→ page 28)

Using open source software

This product uses open source software based on the BSD license. The BSD license is a software license system that grants program distribution subject to the no-warranty stipulation and the presentation of a copyright notice and license clause list. The following information is displayed based on the above-mentioned license conditions and does not prescribe any restrictions on use for the customer.

Copyright (C) 2001 Richard Herveille
richard@asics.ws

This source file may be used and distributed without restriction provided that this copyright statement is not removed from the file and that any derivative work contains the original copyright notice and the associated disclaimer.

THIS SOFTWARE IS PROVIDED "AS IS" AND WITHOUT ANY EXPRESS OR IMPLIED WARRANTIES, INCLUDING, BUT NOT LIMITED TO, THE IMPLIED WARRANTIES OF MERCHANTABILITY AND FITNESS FOR A PARTICULAR PURPOSE. IN NO EVENT SHALL THE AUTHOR OR CONTRIBUTORS BE LIABLE FOR ANY DIRECT, INDIRECT, INCIDENTAL, SPECIAL, EXEMPLARY, OR CONSEQUENTIAL DAMAGES (INCLUDING, BUT NOT LIMITED TO, PROCUREMENT OF SUBSTITUTE GOODS OR SERVICES; LOSS OF USE, DATA, OR PROFITS; OR BUSINESS INTERRUPTION) HOWEVER CAUSED AND ON ANY THEORY OF LIABILITY, WHETHER IN CONTRACT, STRICT LIABILITY, OR TORT (INCLUDING NEGLIGENCE OR OTHERWISE) ARISING IN ANY WAY OUT OF THE USE OF THIS SOFTWARE, EVEN IF ADVISED OF THE POSSIBILITY OF SUCH DAMAGE.

