

Compact In-Desk Connectivity with 1x Mains (North America/ Multi-Standard), USB Charging, HDMI & USB-C Passthrough

IDB-200-NA | IDB-200-MS



Quickstart Guide

! WyreStorm recommends reading through this document in its entirety to become familiar with the product's features before beginning the installation process.



! IMPORTANT! Installation Requirements

- Read through the [Wiring and Connections](#) section for important wiring guidelines before creating or choosing premade cables.
- Visit the product page to download the latest firmware, document version, additional documentation, and configuration tools.

In the Box

1x IDB-200-NA or IDB-200-MS

Mounting Instructions

WyreStorm recommends that you read through this section in its entirety before installing to ensure proper operation and to avoid damaging the equipment.

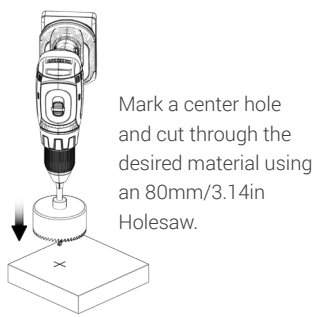

Mark a center hole and cut through the desired material using an 80mm/3.14in Holesaw.

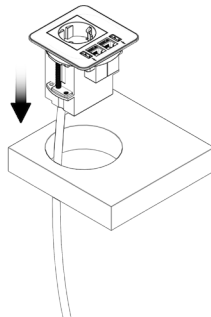

Once the hole has been cut to size, the product should simply slot into place. Make sure all cables are passed through the hole first.

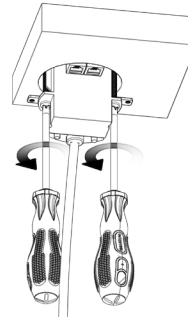

When the In-desk plate is situated in the hole, you can tighten the product in place by screwing the two Philips head screws at the bottom of the product.

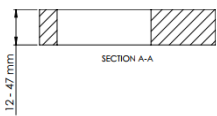

For installation, table depth must be between 12-47mm

Opening Instructions

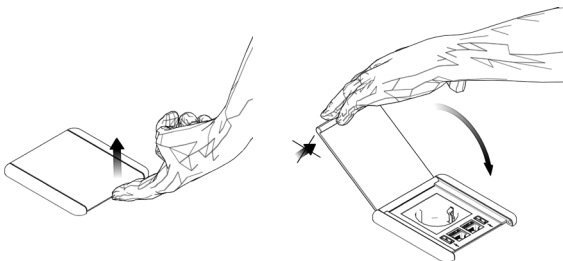

Open the product by simply pressing the button on the top of the flap. You can also open by just lifting up the flap. To close the unit, gently push the flap downwards until it clicks.

Mains Wiring

The MS models of the IDB products use a Wieland EPN 1114 mains connector. This connector requires a compatible power supply cable with an EPN 1115 connector and the proper plug type based on country of installation. The WyreStorm IDB-PWR-UK or IDB-PWR-SCH can be purchased separately and used with the IDB-MS products which are compatible with most European countries.

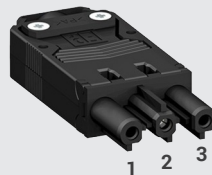

Power cable end, stripped and prepared for female Wieland connector installation.

WyreStorm Connector		3rd Party Device
Pin 1 L (Live)	----> To ---->	L (Live)
Pin 2 G (Ground)	----> To ---->	G (Ground)
Pin 3 N (Neutral)	----> To ---->	N (Neutral)

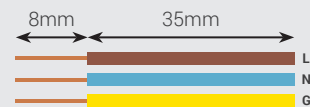

Wiring and Connections

WyreStorm recommends that all wiring for the installation is run and terminated prior to making connections to the deskplate. Read through this section in its entirety before running or terminating any wires to ensure proper operation and to avoid damaging the equipment.

IMPORTANT! Wiring Guidelines

- WyreStorm recommends using pre-terminated cables due to the complexity of these connector types. Using pre-terminated cables will ensure that these connections are accurate and will not interfere with the performance of the product.
- This product contains a USB-C connection that can be used as an audio/video input. When using this connection verify that the USB-C cable used supports audio/video functionality as not all USB-C cables support this requirement.

Troubleshooting

No or Poor Quality Picture (snow or noisy image)

- Verify that all HDMI connections are not loose and are functioning properly.
- Verify that USB-C connections are not loose and are functioning properly.
- If transmitting 4K, verify that the HDMI cables used are 4K rated.

Troubleshooting Tips

- WyreStorm recommends using a cable tester or connecting the cable to other devices to verify functionality.

Specifications

	IDB-200-NA	IDB-200-MS
Audio and Video		
Inputs	1 x Mains outlet (North American Type B) 1 x USB-C 1 x HDMI 2 x USB Type A Charging Ports	1 x Mains outlet (Multi-standard) 1 x USB-C 2 x HDMI 2 x USB Type A Charging Ports
Video Passthrough (Max)	HDMI: 3840x2160 @60Hz 4:4:4 8bit USB-C: 3840x2160 @30Hz 4:4:4 8bit	
Power		
Mains Connection	Voltage: 100-250VAC Current: Max: 16A Frequency: 50-60Hz Integrated 3 meter mains cable (Type B plug) Total power of simultaneously connected devices must not exceed 3.6kW	Voltage: 100-250VAC Current: Max 16A Frequency: 50-60Hz Integrated 40cm Weiland connector (EPN 1114) Total power of simultaneously connected devices must not exceed 3.6kW
USB Charging	5v 2.4a per port	
Environmental		
Operating Temperature	0 to +45°C (32 to + 113 °F), 10% to 90%, non-condensing	
Dimensions and Weight		
Length x Width x Height	Top surface: 85mm x 85mm Under table depth: 80mm Under table width: 79.8mm Can be mounted in surfaces between 12-47mm thick	
Weight		
Regulatory		
Safety and Emission	CE FCC RoHS RCM EAC	

Note: WyreStorm reserves the right to change product specification, appearance or dimensions of this product at any time without prior notice.

Warranty Information

WyreStorm Technologies LLC warrants that its products to be free from defects in material and workmanship under normal use for a period of five (5) years from the date of purchase. Refer to the Product Warranty page on wyrestorm.com for more details on our limited product warranty.

