

# CONNECTRAC

A brand of **legrand**



## EXPRESS KIT SPEC GUIDE

For installation on top of any flooring surface



## Express Solution for Power & Data

Express Kits are a grab-and-go solution that conveniently manages both power and data cables. Our visible on-floor option works great on top of any flooring surface for both retrofit and new construction applications.

### Features & Benefits

- **Pre-Wired Power**  
A powered Quad Receptacle is attached to a flexible steel conduit that is pre-wired for simple and quick installation.
- **Versatile Data**  
Data accommodates up to 4 Cat-6 data cables and holds up to 4 customizable keystone modules.
- **Low-Profile Transition Ramps**  
Ramps seamlessly transition the wireway to the floor and meet ADA compliance standards.
- **Non-Disruptive Installation**  
Easy to install and can be cut to size in the field, which allows more work during regular business hours.

## HOW IT WORKS

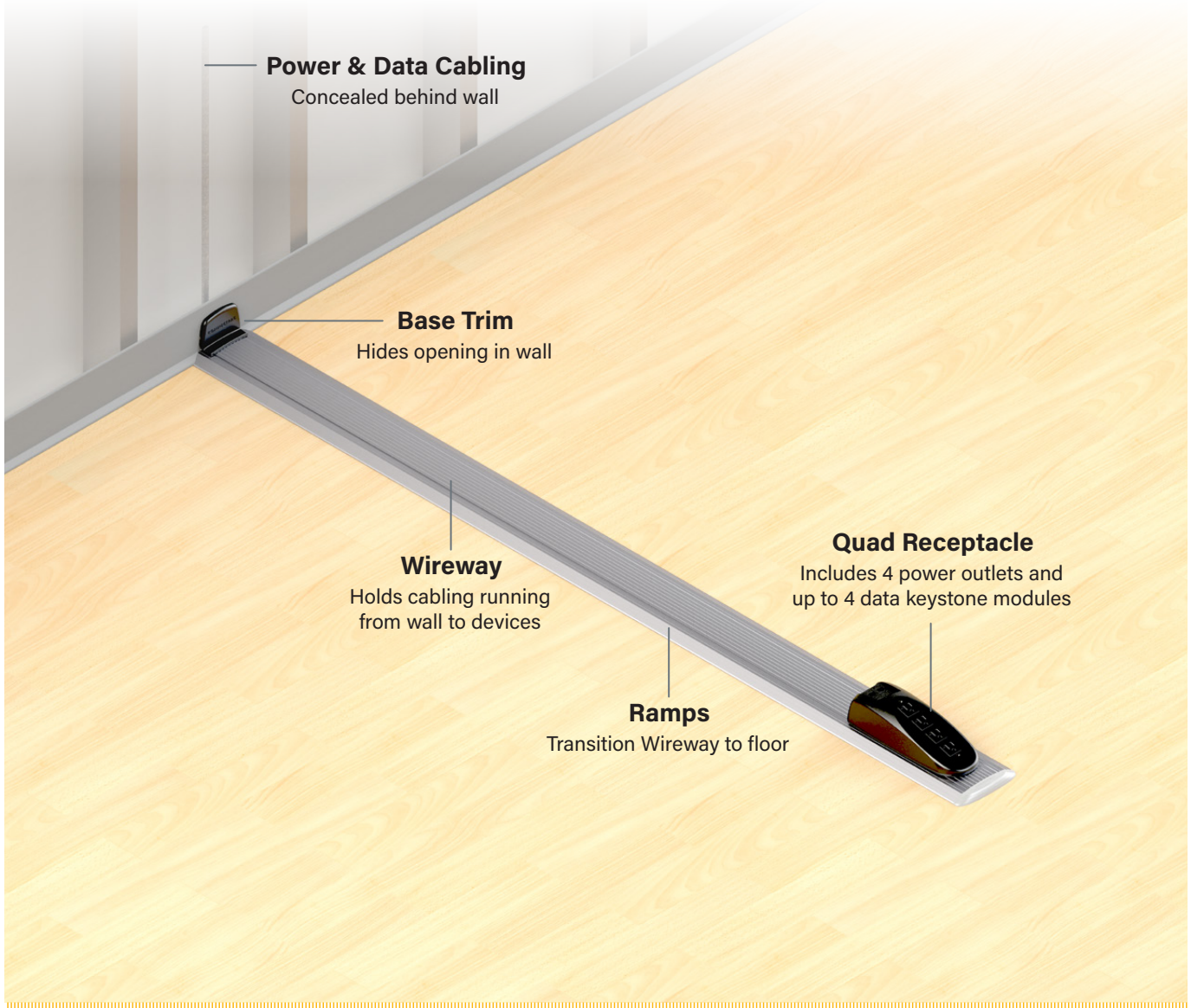

Total System Width: 5.5"

Total System Height: .65"

Available Wireway Lengths: 6', 9', 12'

## COMPONENTS

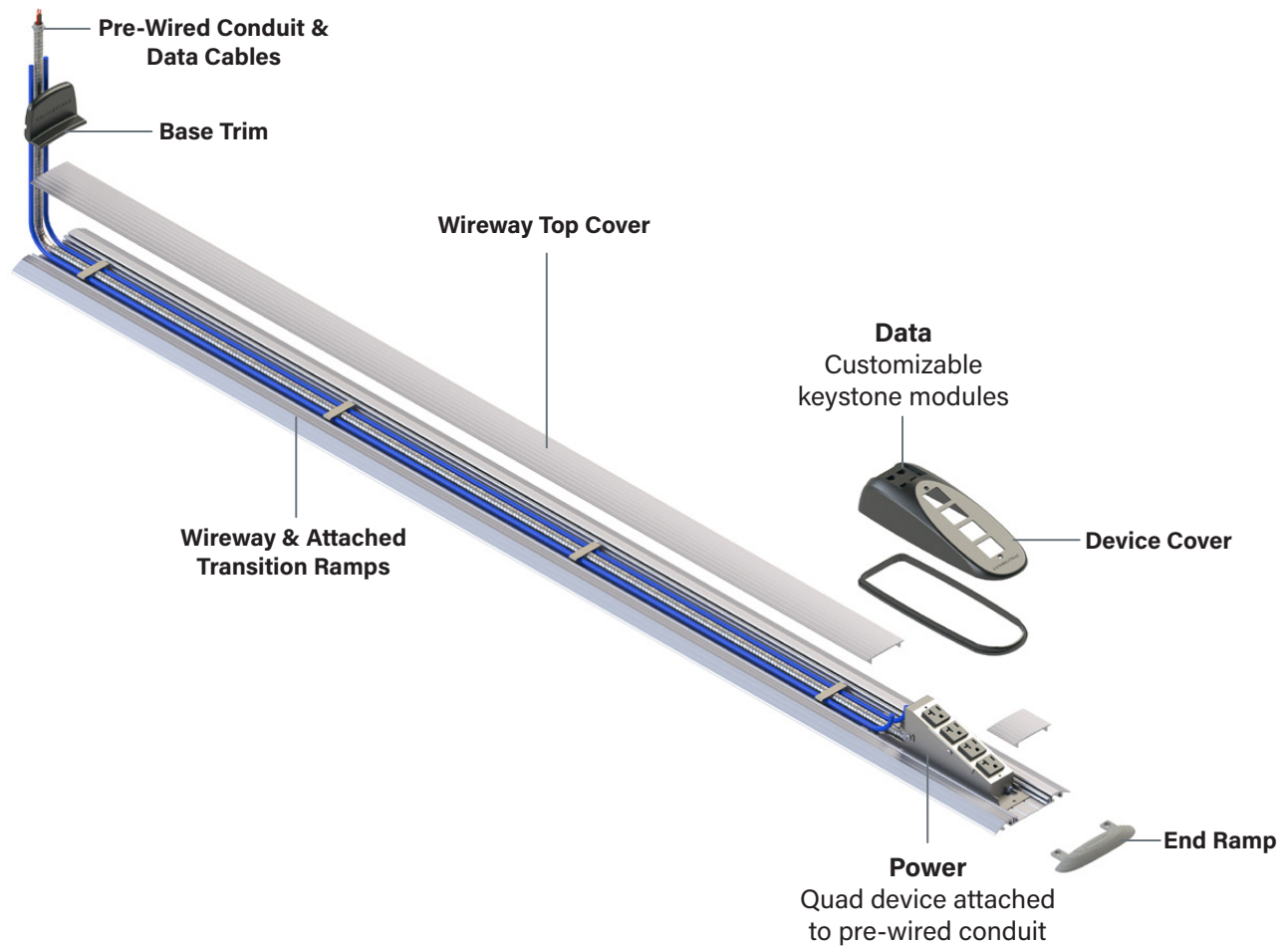

## PRODUCT LISTING

Our Express Kit for installation on top of any flooring surface is a grab-and-go solution that comes complete with all the accessories you need for installation.

To specify, simply choose from our three available lengths below, which can all be cut to size in the field as needed.

<b>Part Number</b>	<b>Description</b>
CT.XPO.1-06-25.1c-SV	6' EXPRESS on floor kit w/ 25' single circuit conduit & quad receptacle. SILVER
CT.XPO.1-09-25.1c-SV	9' EXPRESS on floor kit w/ 25' single circuit conduit & quad receptacle. SILVER
CT.XPO.1-12-25.1c-SV	12' EXPRESS on floor kit w/ 25' single circuit conduit & quad receptacle. SILVER

## OPTIONAL ACCESSORIES

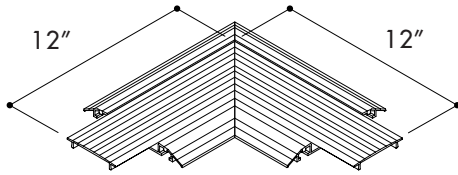

### 90° CORNER KIT *(Available May 2021)*

Allows Wireway to make a 90° turn.

**Part Number:**

CT.XPO.1-AC-C90-SV

**Description:**

EXPRESS on floor CORNER. 90 degree complete kit.

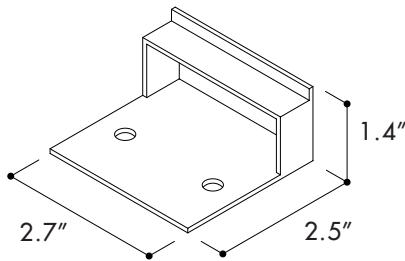

### ROUGH-IN FRAME

Installed before drywall to provide a rough opening for cabling.

**Part Number:**

CT.XPO.1-AC-RIF

**Description:**

Rough-In Frame

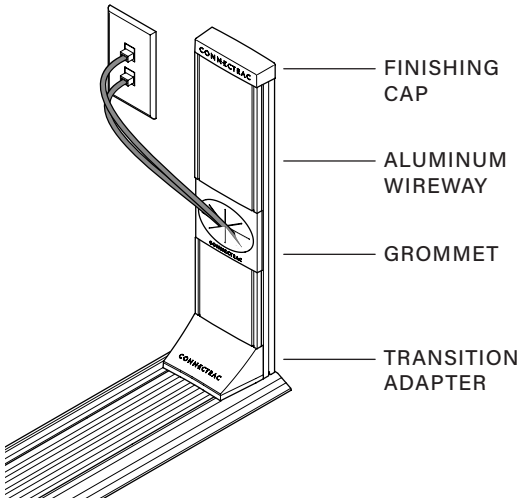

### WALL CHANNEL KIT *(Available May 2021)*

The Wall Channel Kit comes in two sizes (2', 12') and is used when power/data cabling is running outside the wall. The 2' Wall Channel Kit is designed to connect to an existing wall outlet box, while the 12' Wall Channel Kit is designed for running conduit up the wall to connect to a junction box. Both sizes can be cut to size in the field.

**Part Number:**

CT.XPO.1-AC-WT-02-SV

CT.XPO.1-AC-WT-12-SV

**Description:**

2' Wall Channel Kit

12' Wall Channel Kit

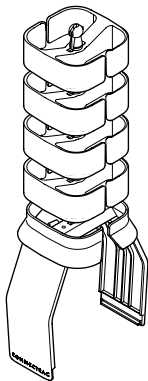

### VERTICAL WIRE MANAGER

Attaches to any power or data device to manage cabling.

**Part Number:**

CT.AC-WMV.1-DG

**Description:**

Vertical Wire Manager

# QUAD RECEPTACLE

These components are included with each quad device:

**DATA**

Provides unloaded modules to mount up to 4 keystone modules, as well as blanks if necessary



**DEVICE COVER**

Attaches to top of device



**TRIM SKIRT**

Snaps into Device Cover

**POWER**

Powered quad device attached to a flexible steel conduit that is pre-wired

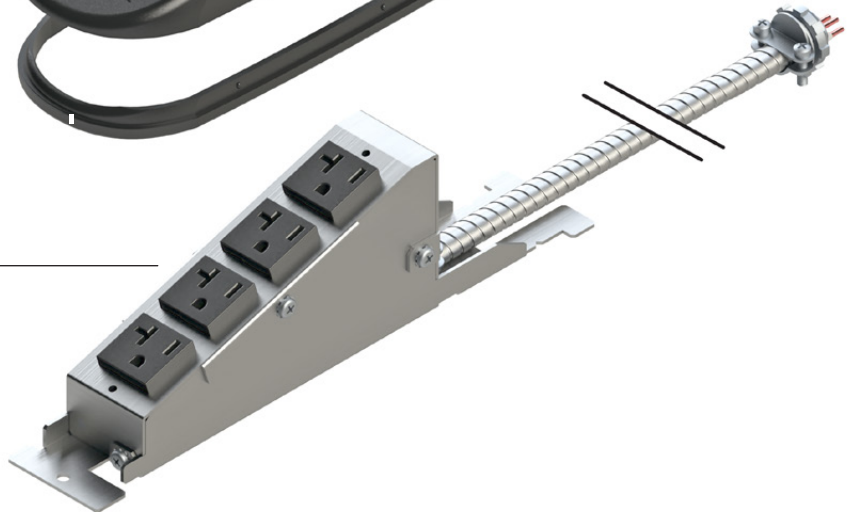

**DEVICE INFORMATION**

**NAME:** Quad Receptacle

**DESCRIPTION:** The Quad Receptacle is a pre-wired, 20-amp outlet device available in a single-circuit option. The device includes 4 power outlets and up to 4 customizable data keystone modules.

**ELECTRICAL LISTING:** **US:** This device meets UL 111 standards for multioutlet assemblies and is listed by ETL / Intertek. The device is identified with the ETL Listed Mark.

**Canada:** This device meets CAN/CSA 22.2 No. 62 standards for surface raceway systems and is listed by ETL / Intertek. The device is identified with the cETL Listed Mark.

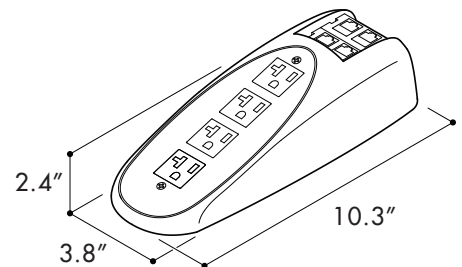

## TECHNICAL INFO

### WIREWAY CAPACITY

Alongside the shielded flexible power conduit, the Wireway can accommodate up to 4 low-voltage Cat-6 cables (data, telecom, AV):

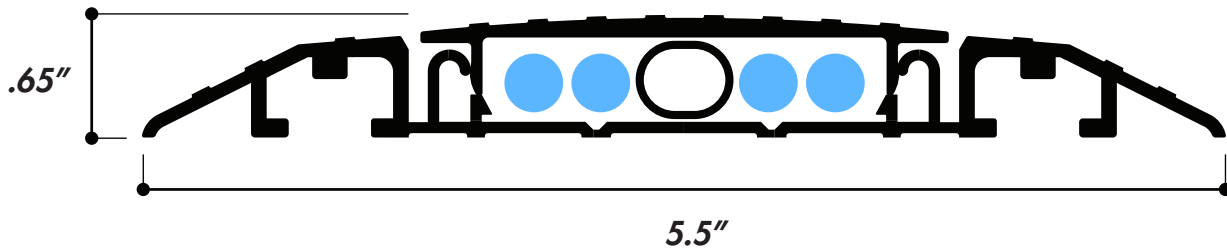

### WIREWAY DIMENSIONS

Outside Dimensions: **2.7" x .65"**

Inside Dimensions: **2" x .4"**

### WEIGHT CAPACITY

Connectrac systems are designed to withstand loads up to 1000 pounds.

### WIRING DIAGRAM

Express Kits are single-circuit, pre-wired systems. The flexible conduit includes a 1/2" knockout fitting and typically connects to a junction box in the wall or ceiling.

