

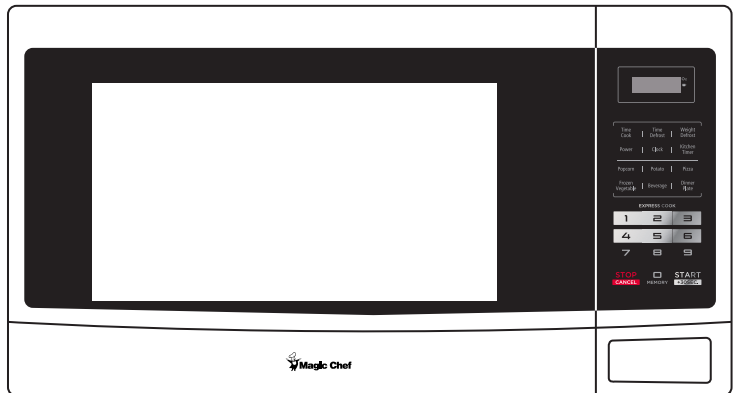

1.6 Cu. Ft. Countertop Microwave Oven

User's Manual



Model MCM1611W
MCM1611B

**PLEASE READ THIS MANUAL CAREFULLY BEFORE USING YOUR
MICROWAVE OVEN AND KEEP IT FOR FUTURE REFERENCE.**



Product Registration

Thank you for purchasing a Magic Chef product. The first step to protect your new product is to complete the product registration on our website: www.mcappliance.com/register. The benefits of registering your product include the following:

1. Registering your product will allow us to contact you regarding a safety notification or product update.
2. Registering your product will allow for more efficient warranty service processing when warranty service is required.
3. Registering your product could act as your proof of purchase in the event of insurance loss.

Once again, thank you for purchasing a Magic Chef product.

PRECAUTIONS TO AVOID POSSIBLE EXPOSURE TO EXCESSIVE MICROWAVE ENERGY

- (a) **Do not attempt to operate this oven with the door open** since open-door operation can result in harmful exposure to microwave energy. It is important not to defeat or tamper with the safety interlocks.
- (b) **Do not place any object** between the oven front face and the door or allow soil or cleaner residue to accumulate on sealing surfaces.
- (c) **Do not operate the oven if it is damaged.** It is particularly important that the oven door close properly and that there is no damage to the: (1) door (bent), (2) hinges and latches (broken or loosened), (3) door seals and sealing surfaces.
- (d) The oven should not be adjusted or repaired by anyone except properly qualified service personnel.

TABLE OF CONTENTS

- PRECAUTIONS TO AVOID POSSIBLE EXPOSURE TO EXCESSIVE MICROWAVE ENERGY..... 1
- IMPORTANT SAFETY INSTRUCTIONS..... 3
- FEDERAL COMMUNICATIONS COMMISSION
RADIO FREQUENCY INTERFERENCE STATEMENT..... 4
- GROUNDING INSTRUCTIONS..... 4
- INSTALLATION..... 5
- SPECIFICATIONS..... 6
- PARTS AND FEATURES..... 7
 - TURNABLE..... 7
- MICROWAVE OVEN CONTROL..... 7
 - DISPLAY..... 7
 - START..... 8
 - ADD 30 SECONDS..... 8
 - EXPRESS COOK..... 8
 - STOP/CANCEL..... 8
 - CLOCK..... 8
 - TONES..... 8
 - KITCHEN TIMER..... 8
 - CONTROL LOCK..... 8
- MICROWAVE OVEN USE..... 9
 - FOOD CHARACTERISTICS..... 9
 - COOKING GUIDELINES..... 9
 - COOKWARE AND DINNERWARE..... 9
 - ALUMINUM FOIL AND METAL..... 10
 - MICROWAVE COOKING POWER..... 10
 - MANUAL COOKING..... 11
 - COOKING IN STAGES..... 11
 - DEFROST..... 11
 - MEMORY..... 12
 - POPCORN..... 12
 - POTATO..... 12
 - PIZZA..... 13
 - BEVERAGE..... 13
 - DINNER PLATE..... 13
 - FROZEN VEGETABLE..... 13
- CARE OF YOUR MICROWAVE OVEN..... 14
- BEFORE YOU CALL FOR SERVICE..... 15
- CARE AND CLEANING..... 15
- QUESTIONS AND ANSWERS..... 16
- USE YOUR MICROWAVE OVEN SAFELY..... 17
- ARCING..... 17
- MICROWAVE OVEN WARRANTY..... 18

IMPORTANT SAFETY INSTRUCTIONS

When using electrical appliances, basic safety precautions should be followed, including the following: **WARNING-To reduce the risk of burns, electric shock, fire, injury to persons or exposure to excessive microwave energy:**

1. Read all instructions before using the appliance.
2. Read and follow the specific "PRECAUTIONS TO AVOID POSSIBLE EXPOSURE TO EXCESSIVE MICROWAVE ENERGY" found on page 1.
3. This appliance must be grounded. Connect only to properly grounded outlet. See "GROUNDING INSTRUCTIONS" found on page 4.
4. Install or locate this appliance only in accordance with the provided installation instructions.
5. Some products such as whole eggs and sealed containers - for example, closed glass jars are able to explode and should not be heated in this oven.
6. Use this appliance only for its intended use as described in this manual. Do not use corrosive chemicals or vapors in this appliance. This type of oven is specifically designed to heat, cook, or dry food. It is not designed for industrial or laboratory use.
7. As with any appliance, close supervision is necessary when used by children.
8. Do not operate this appliance if it has a damaged cord or plug, if it is not working properly, or if it has been damaged or dropped.
9. This appliance should be serviced only by qualified service personnel.
Contact nearest authorized service facility for examination, repair or adjustment.
10. Do not cover or block any openings on the appliance.
11. Do not store this appliance outdoors. Do not use this product near water — for example, near a kitchen sink, in a wet basement, near a swimming pool, or similar locations.
12. Do not immerse cord or plug in water.
13. Keep cord away from heated surfaces.
14. Do not let cord hang over edge of table or counter.
15. When cleaning surfaces of door and oven that comes together on closing the door, use only mild, non-abrasive soaps or detergents applied with a sponge or soft cloth.
16. To reduce the risk of fire in the oven cavity:
 - a) Do not overcook food. Carefully attend appliance when paper, plastic, or other combustible materials are placed inside the oven to facilitate cooking.
 - b) Remove wire twist-ties from paper or plastic bags before placing bag in oven.
 - c) If materials inside the oven ignite, keep oven door closed, turn oven off, and disconnect the power cord, or shut off power at the fuse or circuit breaker panel.
 - d) Do not use the cavity for storage purposes. Do not leave paper products, cooking utensils, or food in the cavity when not in use.
17. Liquids, such as water, coffee, or tea are able to be overheated beyond the boiling point without appearing to be boiling due to surface tension of the liquid. Visible bubbling or boiling when the container is removed from the microwave oven is not always present. **THIS COULD RESULT IN VERY HOT LIQUIDS SUDDENLY BOILING OVER WHEN SPOON OR OTHER UTENSIL IS INSERTED INTO THE LIQUID.**

To reduce the risk of injury to persons:

 - a) Do not overheat the liquid.
 - b) Stir the liquid both before and halfway through heating it.
 - c) Do not use straight-sided containers with narrow necks.
 - d) After heating, allow the container to stand in the microwave oven for a short time before removing the container.
 - e) Use extreme care when inserting a spoon or other utensil into the container.
18. Do not use this microwave oven to heat corrosive chemicals (for example, sulfides and chlorides). Vapors from such corrosive chemicals may interact with the contact and springs of the safety interlock switches thereby rendering them inoperable.
19. Keep the waveguide cover clean at all times. Wipe the oven interior with a soft damp cloth after each use. If you leave grease or fat anywhere in the cavity it may overheat, smoke or even catch fire when next using the oven.
20. Never heat oil or fat for deep frying as you cannot control the temperature and doing so may lead to overheating and fire.
21. Do not operate the oven without the glass tray in place. Be sure it is properly sitting on the rotating base.

SAVE THESE INSTRUCTIONS

FEDERAL COMMUNICATIONS COMMISSION RADIO FREQUENCY INTERFERENCE STATEMENT

WARNING:

This equipment generates and uses ISM frequency energy and if not installed and used properly, that is in strict accordance with the manufacturer's instructions, may cause interference to radio and television reception.

It has been type-tested and found to comply with limits for an ISM Equipment pursuant to part 18 of FCC Rules, which are designed to provide reasonable protection against such interference in a residential installation.

However, there is no guarantee that interference will not occur in a particular installation. If this equipment does cause interference to radio or television reception, which can be determined by turning the equipment off and on, the user is encouraged to try to correct the interference by one or more of the followings.

- Reorient the receiving antenna of radio or television.
- Relocate the Microwave oven with respect to the receiver.
- Move the microwave oven away from the receiver.
- Plug the microwave oven into a different outlet so that microwave oven and receiver are on different branch circuits.

THE MANUFACTURER is not responsible for any radio or TV interference caused by UNAUTHORIZED MODIFICATION to this microwave oven. It is the responsibility of the user to correct such interference.

GROUNDING INSTRUCTIONS

This appliance must be grounded. In the event of an electrical short circuit, the grounding plug reduces the risk of electric shock by providing an escape wire for electric current. This appliance is equipped with a cord having a grounding wire with a grounding plug. The plug must be plugged into an outlet that is properly installed and grounded.

WARNING:

Improper use of the grounding can result in a risk of electric shock.

Consult a qualified electrician or serviceman if the grounding instructions are not completely understood, or if doubt exists as to whether the appliance is properly grounded, and either :

If it is necessary to use an extension cord, use only a 3-wire extension cord that has a 3-blade grounding plug, and a 3-slot receptacle that will accept the plug on the appliance. The marked rating of the extension cord shall be equal to or greater than the electrical rating of the appliance.

WARNING:

Do not cut or remove the third (ground) prong from the power cord under any circumstances.

INSTALLATION

1. Examine the oven after unpacking.

Check for damage such as a misaligned door, broken door or dent in the cavity.

If any damage is visible, DO NOT INSTALL, and notify your dealer immediately.

2. Level, flat location.

Install the microwave oven on a level, flat surface.

3. Ventilation.

Do not block air vents. If they are blocked during operation, the oven may overheat and eventually cause a failure.

For proper ventilation, allow 4 inches (10.16 cm) of space between oven top, sides, rear and adjacent surfaces.

4. Away from radio and TV sets.

Poor television reception and radio interference may result if the oven is located close to a TV, radio, antenna, feeder, etc.

Place the oven as far from them as possible.

5. Away from heating appliances and water taps.

Keep the oven away from heat, steam or splashing liquids. These things can adversely affect oven wiring and contacts.

6. Power supply.

- Check your local power source.

This microwave oven requires a current of approximately 15 amperes, AC 120Volts, 60Hz grounded outlet.

1. A short power-supply cord is provided to reduce the risks resulting from becoming entangled in or tripping over a longer cord.

2. Longer cord sets or extension cords are available and may be used if care is exercised in their use.

3. If a long cord or extension cord is used:

- The marked electrical rating of the cord set or extension cord should be at least as great as the electrical rating of the appliance.

- The extension cord must be a grounding type 3-wire cord.

- The longer cord should be arranged so that it will not drape over the counter top or tabletop where it can be pulled on by children or tripped over unintentionally.

7. The minimum height of free space necessary above the top surface of the oven is about 4 inches (10.16 cm).

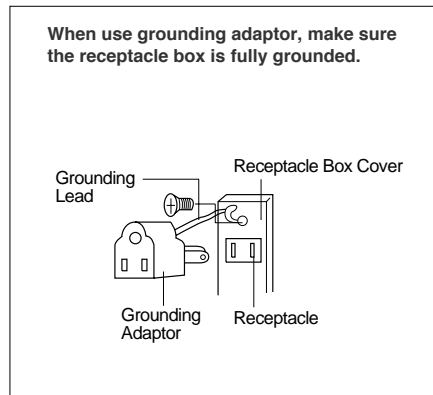
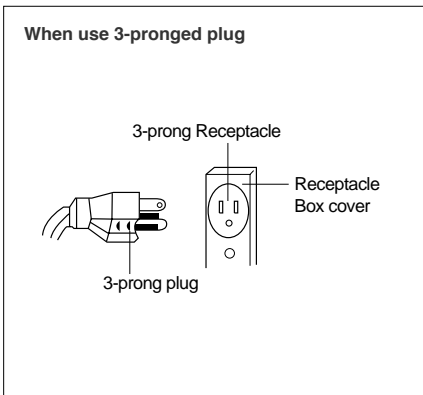

“THE CANADIAN ELECTRICAL CODE DOES NOT ALLOW THE USE OF THE GROUNDING ADAPTOR”

SPECIFICATIONS

POWER SUPPLY		120V AC, 60Hz SINGLE PHASE WITH GROUNDING
MICROWAVE	INPUT POWER	1550 W
	ENERGY OUTPUT	1100W
	FREQUENCY	2,450MHz
OUTSIDE DIMENSIONS (W x H x D)		553 x 326.1 x 455 mm (21.8 x 12.8 x 17.9 in)
CAVITY DIMENSIONS (W x H x D)		394 x 260 x 433 mm (15.5 x 10.2 x 17.0 in)
CAVITY VOLUME		1.6 cu.ft
NET WEIGHT		APPROX. 36.6 lbs.
TIMER		99 min. 99 sec.
POWER LEVELS		10 Levels

** Specifications are subject to change without notice.*

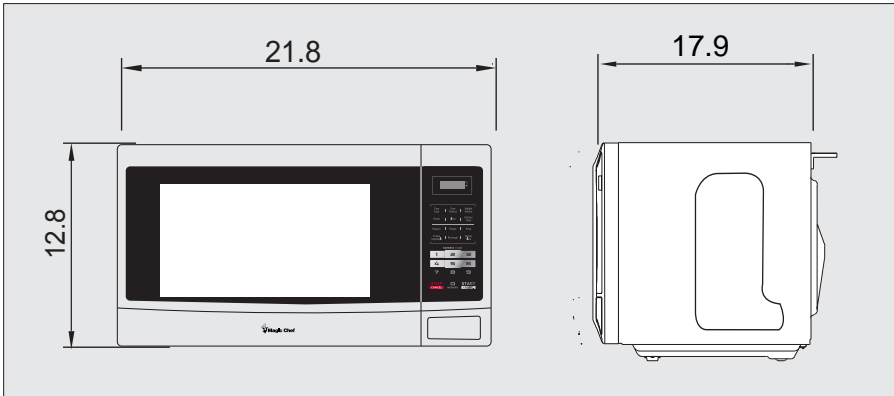

PARTS AND FEATURES

This manual may cover several different models. The model you have purchased may have some or all of the features shown here. The appearance of your particular model may differ slightly from the illustrations in this manual.

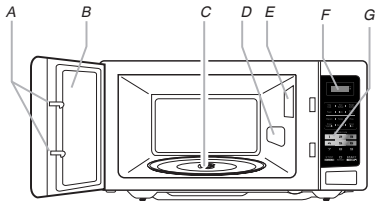

- A. Door lock system
- B. Metal shielded window
- C. Glass turntable
- D. Microwave inlet cover
- E. Microwave oven light
- F. Display
- G. Control panel

Turntable

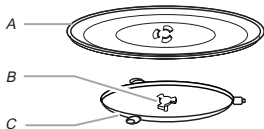

- A. Turntable
- B. Hub
- C. Roller Guide

The turntable can rotate in either direction to help cook food more evenly. For best cooking results, do not operate the microwave oven without having the turntable in place. See "Assistance or Service" to reorder any of the parts.

To Install:

1. Install the hub into the hole in the center of the microwave oven cavity bottom
2. Place the support on the microwave oven cavity bottom.
3. Place the turntable on the support.

Fit the raised, curved mounds in the center of the turntable bottom between the three spokes of the hub.

MICROWAVE OVEN CONTROL

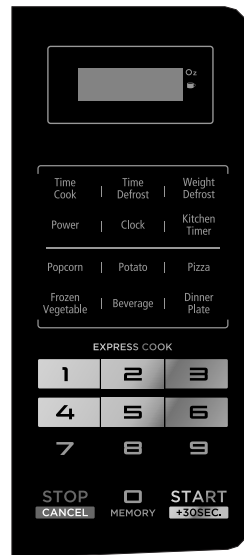

Display

When power is first supplied to the microwave oven, "0:00" will appear in the display. If the "0:00" appears in the display at any other time, a power failure has occurred. Reset the clock if needed. See "Clock" section. When the microwave oven is in use, the display shows cook time remaining. When the microwave oven is not in use, the display shows the time of day (if the clock is set) or Timer countdown.

Start

The START control (START/+30SEC pad) begins any function. If cooking is interrupted by touching STOP/CANCEL or by opening the door, touching START/+30SEC will resume the cycle.

Add 30 Seconds

The +30SEC control (START/+30SEC) automatically starts the microwave oven at 100% power for 30 seconds, and adds 30 seconds of cook time with each additional touch of the control.

Express Cook

Each of the EXPRESS COOK controls (number pads 1-6) automatically starts the microwave oven at 100% power for 1 minute, 2 minutes, 3 minutes, 4 minutes, 5 minutes or 6 minutes, depending on which pad is touched.

Stop/Cancel

The STOP/CANCEL control clears any incorrect command, and pauses and/or cancels any program during cooking. It will not erase the time of day. A cooking program may be paused by touching STOP/CANCEL once or by opening the door. The cycle may be resumed by touching START/+30SEC. A cooking program may be canceled by touching STOP/CANCEL twice, or by opening the door and then touching STOP/CANCEL.

The STOP/CANCEL control is also used to lock and unlock the control panel. See "Control Lock" section.

Clock

This is a standard 12-hour clock (1:00-12:59). If the clock is not set, "0:00" will remain in the display. When the clock is set, the ":" will flash. During cooking, the clock may be seen for 3 seconds by touching CLOCK.

To Set:

The microwave oven must be in standby mode (no functions operating).

1. Touch CLOCK control
"00:00" will appear in the display, with the first "0" flashing.
2. Enter current time, filling all four digits from left to right. The first digit can be only "1" or "0."
3. Touch CLOCK.

Tones

Tones are audible signals that indicate the following:

One tone

1. Valid entry (short tone)
2. End of stage in multistage cooking
3. Control lock activated or deactivated (long tone)

Five tones

1. End of cycle
 2. End of Kitchen Timer countdown
-

Kitchen Timer

The Kitchen Timer can be set in minutes and seconds, up to 99 minutes, 99 seconds, and counts down the set time. The Kitchen Timer may not be used while any other function is operating.

NOTE: The Kitchen Timer does not start or stop the microwave oven.

To Set:

1. Touch KITCHEN TIMER control.
"00:00" will appear in the display, with the first "0" flashing.
 2. Enter desired time in minutes and seconds, filling all four digits from left to right. Example: 1-0-0-0 for 10 minutes, or 0-5-0-0 for 5 minutes.
 3. Touch START/+30SEC.
When the set time ends, end-of-timer tones will sound, and the display will return to the time of day.
 4. Touch STOP/CANCEL at any time during the countdown to cancel the Kitchen Timer.
-

Control Lock

The Control Lock shuts down the control panel pads to avoid unintended use of the microwave oven.

To Lock/Unlock Control: The microwave oven must be in standby mode. Touch and hold STOP/CANCEL for 3 seconds until one long tone sounds and the display clears to show an outline of the display area. Repeat to unlock control, and return the display to the time of day. If any pad is touched while the control is locked, there will be no response from the microwave oven.

MICROWAVE OVEN USE

A magnetron in the microwave oven produces micro-waves which reflect off the metal floor, walls and ceiling and pass through the turntable and appropriate cookware to the food. Microwaves are attracted to and absorbed by fat, sugar and water molecules in the food, causing them to move, producing friction and heat which cooks the food.

1. To avoid damage to the microwave oven, do not lean on or allow children to swing on the microwave oven door.
2. To avoid damage to the microwave oven, do not operate when it is empty.
3. Baby bottles and baby food jars should not be heated in microwave oven.
4. Clothes, flowers, fruit, herbs, wood, gourds, paper, including brown paper bags and newspaper, should not be dried in microwave oven.
5. Paraffin wax will not melt in the microwave oven because it does not absorb microwaves.
6. Use oven mitts or pot holders when removing containers from microwave oven.
7. Do not overcook potatoes. At the end of the recommended cook time, potatoes should be slightly firm. Let potatoes stand for 5 minutes. They will finish cooking while standing.
8. Do not cook or reheat whole eggs inside the shell. Steam buildup in whole eggs may cause them to burst, requiring significant cleanup of microwave oven cavity. Cover poached eggs and allow a standing time.

Food Characteristics

When microwave cooking, the amount, size and shape, starting temperature, composition and density of the food affect cooking results.

Amount of Food

The more food heated at once, the longer the cook time needed. Check for doneness and add small increments of time if necessary.

Size and Shape

Smaller pieces of food will cook more quickly than larger pieces, and uniformly shaped foods cook more evenly than irregularly shaped food.

Starting Temperature

Room temperature foods will heat faster than refrigerated foods, and refrigerated foods will heat faster than frozen foods.

Composition and Density

Foods high in fat and sugar will reach a higher temperature, and will heat faster than other foods. Heavy, dense foods, such as meat and potatoes, require a longer cook time than the same size of a light, porous food, such as cake.

Cooking Guidelines

Covering

Covering food helps retain moisture, shorten cook time and reduce spattering. Use the lid supplied with cookware. If a lid is not available, wax paper, paper towels or plastic wrap approved for microwave ovens may be used. Plastic wrap should be turned back at one corner to provide an opening to vent steam. Condensation on the door and cavity surfaces is normal during heavy cooking.

Stirring and Turning

Stirring and turning redistribute heat evenly to avoid over-cooking the outer edges of food. Stir from outside to center. If possible, turn food over from bottom to top.

Arranging

If heating irregularly shaped or different sized foods, arrange the thinner parts and smaller sized items toward the center. If cooking several items of the same size and shape, place them in a ring pattern, leaving the center of the ring empty.

Piercing

Before heating, use a fork or small knife to pierce or prick foods that have a skin or membrane, such as potatoes, egg yolks, chicken livers, hot dogs, and sausage. Prick in several places to allow steam to vent.

Shielding

Use small, flat pieces of aluminum foil to shield the thin pieces of irregularly shaped foods, bones and foods such as chicken wings, leg tips and fish tail. See "Aluminum Foil and Metal" first.

Standing Time

Food will continue to cook by the natural conduction of heat even after the microwave cooking cycle ends. The length of standing time depends on the volume and density of the food.

Cookware and Dinnerware

Cookware and dinnerware must fit on the turntable. Always use oven mitts or pot holders when handling because any dish may become hot from heat transferred from the food. Do not use cookware and dinnerware with gold or silver trim. Use the following chart as a guide, then test before using.

MATERIAL	RECOMMENDATIONS
Aluminum Foil, Metal	See "Aluminum Foil and Metal" section.
Browning Dish	Bottom must be at least 3/16" (5 mm) above the turntable. Follow manufacturer's recommendations.
Ceramic Glass, Glass	Acceptable for use .

MATERIAL	RECOMMENDATIONS
China, Earthenware	Follow manufacturer's recommendations.
Melamine	Follow manufacturer's recommendations.
Paper:Towels, Dinnerware, Napkins	Use nonrecycled and those approved by the manufacturer for microwave oven use.
Plastic:Wraps, Bags, Covers, Dinnerware, Containers	Use those approved by the manufacturer for microwave oven use.
Pottery and Clay	Follow manufacturer's recommendations.
Silicone Bakeware	Follow manufacturer's recommendations.
Straw, Wicker, Wooden Containers	Do not use in microwave oven.
Wax Paper	Acceptable for use.

To Test Cookware or Dinnerware for Microwave Use:

- Place cookware or dinnerware in microwave oven with 1 cup (250 mL) of water beside it.
- Cook at 100% cooking power for 1 minute. Do not use cookware or dinnerware if it becomes hot and the water stays cool.

Aluminum Foil and Metal

Always use oven mitts or pot holders when removing dishes from the microwave oven. Aluminum foil and some metal can be used in the microwave oven. If not used properly, arcing (a blue flash of light) can occur and cause damage to the microwave oven.

OK for Use

Racks and bakeware supplied with the microwave oven (on some models), aluminum foil for shielding, and approved meat thermometers may be used with the following guidelines:

- To avoid damage to the microwave oven, do not allow aluminum foil or metal to touch the inside cavity walls, ceiling or floor.
- Always use the turntable.
- To avoid damage to the microwave oven, do not allow contact with another metal object during microwave cooking.

Do Not Use

Metal cookware and bakeware, gold, silver, pewter, non-approved meat thermometers, skewers, twist ties, foil liners such as sandwich wrappers, staples and objects with gold or silver trim or a metallic glaze should not be used in the microwave oven.

Microwave Cooking Power

Many recipes for microwave cooking specify which cooking power to use by percent, name or number. For example, 70% = 7 = Medium-High.

Use the following chart as a general guide for the suggested cooking power of specific foods.

PERCENT/ NAME	NUMBER	USE
100%, High (default setting)	10	Quick heating convenience foods and foods with high water content, such as soups, beverages and most vegetables.
90%	9	Cooking small, tender pieces of meat, ground meat, poultry pieces and fish fillets. Heating cream soups.
80%	8	Heating rice, pasta or stirrable casseroles. Cooking and heating foods that need a cook power lower than high. For example, whole fish and meat loaf.
70%, Medium-High	7	Reheating a single serving of food.
60%	6	Cooking sensitive foods such as cheese and egg dishes, pudding and custards. Cooking non-stirrable casseroles, such as lasagna.
50%, Medium	5	Cooking ham, whole poultry and pot roasts. Simmering stews.
40%	4	Melting chocolate. Heating bread, rolls and pastries.
30%, Medium-Low, Defrost	3	Defrosting bread, fish, meats, poultry and precooked foods.
20%	2	Softening butter, cheese, and ice cream.
10%, Low	1	Taking chill out of fruit.
0%	0	Work with fan for no power.

Manual Cooking

To Use:

1. Place food on the turntable and close the door.
 2. Touch TIME COOK.
 3. Enter length of time to cook.
 4. Touch POWER. "PL10" will appear briefly in the display. If cooking with a power other than 100%, touch number keys to select the power levels from highest to lowest. See "Microwave Cooking Power" chart.
 5. Touch START/+30SEC.
The display will count down the set cook time. When the cycle ends, the end-of-cycle tones will sound, and the display will return to the time of day.
 6. Touch STOP/CANCEL at any time during the countdown to pause or cancel cooking.
-

Cooking in Stages

The microwave oven can be set to cook at different cooking powers for various lengths of time, up to 2 stages. One of the stages may be an automatic Defrost function (see "Defrost" section), which will be the first stage.

To Cook in Stages:

1. Place food on the turntable and close the door.
2. Touch TIME COOK.
3. Enter length of time to cook.
4. Touch POWER. "PL10" will appear briefly in the display. If cooking with a power other than 100%, touch number keys to select the power levels from highest to lowest. See "Microwave Cooking Power" chart.
5. Touch TIME COOK.
6. Enter length of time to cook for second stage.
7. Touch POWER. "PL10" will appear briefly in the display. If cooking with a power other than 100%, touch number keys to select the power levels from highest to lowest.
8. Touch START/+30SEC.
The display will count down the set cook time for each stage, and a short tone will sound at the end of the first stage.
The power level may be seen for 3 seconds by touching POWER during the cycling stage.
When the cycle ends, the end-of-cycle tones will sound, and the display will return to the time of day.
9. Touch STOP/CANCEL at any time during the countdown to pause or cancel cooking.

Cook time may be added in 30-second increments during the second stage by touching START/+30SEC control.

To Use Defrost As First Stage: Touch Weight Defrost, "dEF1" appears in the display. Enter the number of ounces between 4 and 100 ounces (see "Defrost" section), then follow steps 5-8 above for second stage programming.

Defrost

The Defrost feature has two functions: dEF1, which is an automatic defrost by weight, and dEF2, which is a manual defrost by time. The default power level is 30%, and can be adjusted.

1. Unwrap foods and remove lids (for example, from fruit juice containers) before defrosting.

2. Shallow packages will defrost more quickly than deep blocks.
 3. Separate food pieces as soon as possible during or at the end of the cycle for more even defrosting.
 4. Use small pieces of aluminum foil to shield parts of food such as chicken wings, leg tips and fish tails. See "Aluminum Foil and Metal" first.
- The Defrost feature should not be used for food that has been left outside the freezer for more than 20 minutes, or for frozen ready-made food. Use the following chart as a guide.
-

MEAT

Beef: ground, steaks, roast, stew	The narrow or fatty areas of irregular shaped cuts should be shielded with foil before defrosting.
Lamb: stew and chops	
Pork: chops, ribs, roasts, sausage	Do not defrost less than 1/4 lb (113 g) or two 4 oz (113 g) patties. Place all meats in microwave-safe baking dish. Do not cover.

POULTRY

Chicken: whole and cut up	Place in microwave-safe baking dish, chicken breast side up. Do not cover.
Cornish hens	
Turkey: breast	

FISH

<i>Fillets, Steaks, Whole Shellfish</i>	Place in microwave-safe baking dish. Do not cover.
---	--

To Defrost by Weight:

1. Place food, uncovered, on the turntable and close the door.
2. Touch WEIGHT DEFROST. "dEF1" will appear.
3. Enter the weight in ounces, from 4 to 100.
If an invalid value is entered, the microwave oven will not start.
4. Touch START/+30SEC.
The display will count down the defrost time. When the cycle ends, the end-of-cycle tones will sound, and the display will return to the time of day.
5. Touch STOP/CANCEL at any time during the countdown to pause or cancel cooking.

To Defrost by Time:

1. Place food, uncovered, on the turntable and close the door.
2. Touch TIME DEFROST. "dEF2" will appear in the display.
3. Enter the desired time for defrosting.
The default microwave power is power level 3. If you want to change the power level, press "POWER" once, and the LED will display "PL 3", then press the number pad of the power level you wanted.
4. Touch START/+30SEC.
The display will count down the defrost time. When the cycle ends, the end-of-cycle tones will sound, and the display will return to the time of day.
5. Touch STOP/CANCEL at any time during the count down to pause or cancel cooking.

Memory

The Memory feature can store up to 3 unique cooking programs. The Auto Menu functions cannot be programmed as a memory function.

To Set Memory :

1. Touch MEMORY control. "1" will appear in the display for the first memory program.
2. Set the program, following the instructions in "Manual Cooking" or "Cooking in Stages."
3. Touch START/+30SEC. . A valid entry tone will sound, indicating that the program has been accepted to memory.
or
Touch START/+30SEC. again. The program will immediately start, and it will be saved to memory

To Set Second and Third Memory Programs: Touch MEMORY twice or three times, then follow steps 2 and 3 above.

To Use Memory :

1. Place food on the turntable and close the door.
2. Touch MEMORY repeatedly until the desired program number is displayed.
3. Touch START/+30SEC.
The display will count down the program cook time.
When the cycle ends, the end-of-cycle tones will sound, and the display will return to the time of day.
4. Touch STOP/CANCEL at any time during the countdown to pause or cancel cooking.

Popcorn

PAD	TOUCH	DISPLAY	SERVING SIZE
POPCORN	Once	1.75	1.75 oz (50 g)
	2 times	3.0	3.0 oz (85 g)
	3 times	3.5	3.5 oz (99 g)

NOTE: During Popcorn function, as with all microwave cooking functions, the microwave oven should be attended at all times. Listen for popping to slow to 1 pop every 1 or 2 seconds, then stop the cycle.

1. To avoid damage to the microwave oven, do not use regular paper bags or glassware.
2. Pop only one package of popcorn at a time.
3. Follow manufacturer's instructions when using a microwave popcorn popper.
4. For best cooking results, do not try to pop unpopped kern
5. Use fresh bags of popcorn for optimal results.
6. Cooking results may vary by brand and fat content. For bag sizes not listed in this section, follow directions on the package.

To Use POPCORN:

1. Place popcorn bag on the turntable, and close the door.
2. Touch POPCORN to select size (see chart).
3. Touch START/+30SEC.
The display will count down the popping time.
When the cycle ends, the end-of-cycle tones will sound, and the display will return to the time of day.
4. Touch STOP/CANCEL at any time during the countdown to pause or cancel popping.

Potato

PAD	TOUCH	DISPLAY	SERVING SIZE
POTATO	Once	1	1, 8-oz (230g) potato
	2 times	2	2, 16-oz (460g) potatoes
	3 times	3	3, 24-oz (690g) potatoes

1. Pierce each potato several times with a fork before baking.
2. Place a single potato on the turntable, off to the side (not centered). Place 2 or 3 potatoes on the turntable around the edges, at least 1" (2.5 cm) apart.
3. Let potato(es) stand for 5 minutes after baking.

To Use POTATO:

1. Place potato(es) on the turntable and close the door.
2. Touch POTATO to select number of potatoes (see chart).
3. Touch START/+30SEC.
The display will count down the cook time.
When the cycle ends, the end-of-cycle tones will sound, and the display will return to the time of day.
4. Touch STOP/CANCEL at any time during the countdown to pause or cancel cooking.

Pizza

PAD	TOUCH	DISPLAY	SERVING SIZE
PIZZA	Once	4.0	1, 4-oz (113 g) slice
	2 times	8.0	2, 8-oz (230 g) slices
	3 times	14.0	3, 14-oz (400 g) slices

- Place pizza slice(s) on a paper towel or paper plate.

To Use PIZZA:

- Place pizza on the turntable, and close the door.
- Touch PIZZA to select number of slices (see chart).
- Touch START/+30SEC.

The display will count down the reheat time.

When the cycle ends, the end-of-cycle tones will sound, and the display will return to the time of day.

- Touch STOP/CANCEL at any time during the countdown to pause or cancel heating.

Beverage

PAD	TOUCH	DISPLAY	SERVING SIZE
BEVERAGE	Once	1	1, 4-oz (120 mL) cup
	2 times	2	2, 8-oz (240 mL) cups
	3 times	3	3, 12-oz (360 mL) cups

- Do not cover.
- The diameter of the cup's opening will affect how the liquid heats. Beverages in cups with smaller openings may heat faster.

To Use BEVERAGE:

- Place cup(s) on the turntable, and close the door.
- Touch BEVERAGE to select amount (see chart).
- Touch START/+30SEC.
The display will count down the heat time.
When the cycle ends, the end-of-cycle tones will sound, and the display will return to the time of day.
- Touch STOP/CANCEL at any time during the countdown to pause or cancel heating.

Dinner Plate

PAD	TOUCH	DISPLAY	SERVING SIZE
DINNER PLATE	Once	9.0	9.0 oz (255 g)
	2 times	12.0	12.0 oz (340 g)
	3 times	18.0	18.0 oz (510 g)

- Place food on plate(s), cover with plastic wrap and vent.

To Use DINNER PLATE:

- Place dinner plate on the turntable and close the door.
- Touch DINNER PLATE to select size (see chart).
- Touch START/+30SEC.

The display will count down the cook time.

When the cycle ends, the end-of-cycle tones will sound, and the display will return to the time of day.

- Touch STOP/CANCEL at any time during the countdown to pause or cancel heating.

Frozen Vegetable

PAD	TOUCH	DISPLAY	SERVING SIZE
FROZEN VEGETABLE	Once	4.0	4.0 oz (113 g)
	2 times	8.0	8.0 oz (230 g)
	3 times	16.0	16.0 oz (460g)

- Remove frozen vegetables from package.
- Place in microwave-safe container.
- Add water:
2 tbs (30mL) to 4.0 oz (113 g) vegetables;
4 tbs (60 mL) to 8.0 oz (230 g) vegetables;
1/3 cup (80mL) to 16.0 oz (460 g) vegetables.
- Cover with plastic wrap and vent.
- Stir and let stand 2-3 minutes after cooking.

To Use FROZEN VEGETABLE:

- Place food on the turntable and close the door.
- Touch FROZEN VEGETABLE to select amount (see chart).
- Touch START/+30SEC.
The display will count down the cook time.
When the cycle ends, the end-of-cycle tones will sound, and the display will return to the time of day.
- Touch STOP/CANCEL at any time during the countdown to pause or cancel cooking.

CARE OF YOUR MICROWAVE OVEN

The oven should be cleaned regularly and any food deposits removed.

Failure to maintain the oven in a clean condition could lead to deterioration of the surface that could adversely affect the life of the appliance and possibly result in a hazardous situation.

- 1 Unplug the power cord before cleaning any part of this oven.
- 2 Keep the inside of the oven clean. When food splatters or spilled liquids adhere to oven walls, wipe with a damp cloth. Mild detergent may be used if the oven gets very dirty. The use of harsh detergent or abrasives is not recommended.
- 3 The outside oven surface should be cleaned with soap and water, rinsed and dried with a soft cloth. To prevent damage to the operating parts inside the oven, water should not be allowed to seep into the ventilation openings.
- 4 If the Control Panel becomes wet, clean with a soft, dry cloth. Do not use harsh detergents or abrasives on Control Panel.
- 5 If steam accumulates inside or around the outside of the oven door, wipe with a soft cloth. This may occur when the microwave oven is operated under high humidity conditions and in no way indicates malfunction of the unit.
- 6 It is occasionally necessary to remove the glass tray for cleaning. Wash the tray in warm sudsy water or in a dishwasher.
- 7 The roller guide and oven cavity floor should be cleaned regularly to avoid excessive noise. Simply wipe the bottom surface of the oven with mild detergent water or window cleaner and dry.

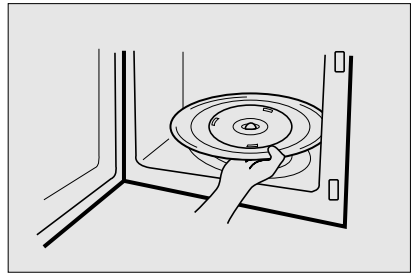

ROLLER GUIDE

- 1 The ROLLER GUIDE and oven floor should be cleaned frequently to prevent excessive noise.
- 2 The ROLLER GUIDE MUST ALWAYS be used for cooking together with the Glass Tray.

GLASS TRAY

- 1 DO NOT operate the oven without the Glass Tray in place.
- 2 DO NOT use any other Glass Tray with this oven.
- 3 If Glass Tray is hot, ALLOW TO COOL before cleaning or placing it in water.
- 4 DO NOT cook directly on the Glass Tray.

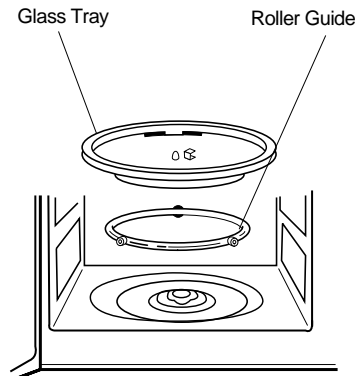

BEFORE YOU CALL FOR SERVICE

Refer to following checklist, you may prevent an unnecessary service call.

*** The oven doesn't work :**

1. Check that the power cord is securely plugged in.
2. Check that the door is firmly closed.
3. Check that the cooking time is set.
4. Check for a blown circuit fuse or tripped main circuit breaker in your house.

*** Sparking in the cavity;**

1. Check utensils. Metal containers or dishes with metal trim should not be used.
2. Check that metal skewers or foil does not touch the interior walls.

If there is still a problem, contact the service station. A list of these stations is included in the oven.

CARE AND CLEANING

Although your oven is provided with safety features, it is important to observe the following:

1. It is important not to defeat or tamper with safety interlocks.
 - i) Door(bent)
 - ii) Hinges and Hookes(broken or loosened)
 - iii) Door seals and sealing surfaces.
2. Do not place any object between the oven front face and the door or allow residue to accumulate on sealing surfaces. Wipe the sealing area frequently with a mild detergent, rinse and dry. Never use abrasive powders or pads.
3. When opened, the door must not be subjected to strain, for example, a child hanging on an opened door or any load could cause the oven to fall forward to cause injury and also damage to the door. Do not operate the oven if it is damaged, until it has been repaired by a competent service technician. It is particularly important that the oven closes properly and that there is no damage to the:
4. The oven should not be adjusted or repaired by anyone except a properly competent service technician.
5. The oven should be cleaned regularly and any food deposits removed;
6. Failure to maintain the oven in a clean condition could lead to deterioration of the surface that could adversely affect the life of the appliance and possibly result in a hazardous situation.

QUESTIONS AND ANSWERS

*** Q : Can the oven be used with the glass tray or roller guide removed?**

A : No. Both the glass tray and roller guide must always be used in the oven before cooking.

*** Q : Can I open the door when the oven is operating?**

A : The door can be opened anytime during the cooking operation. Then microwave energy will be instantly switched off and the time setting will maintain until the door is closed.

*** Q : Why do I have moisture in my microwave oven after cooking?**

A : The moisture on the side of your microwave oven is normal. It is caused by steam from cooking food hitting the cool oven surface.

*** Q : Does microwave energy pass through the viewing screen in the door?**

A : No. The metal screen bounces back the energy to the oven cavity. The holes are made to allow light to pass through. They do not let microwave energy pass through.

*** Q : Why do eggs sometimes pop?**

A : When baking or poaching eggs, the yolk may pop due to steam build-up inside the yolk membrane. To prevent this, simply pierce the yolk with a toothpick before cooking. Never cook eggs without piercing their shells.

*** Q : Why this standing time recommended after the cooking operation has been completed?**

A : Standing time is very important. With microwave cooking, the heat is in the food, not in the oven. Many foods build up enough internal heat to allow the cooking process to continue, even after the food is removed from the oven. Standing time for joints of meat, large vegetables and cakes is to allow the inside to cook completely, without overcooking the outside.

*** Q : What does “standing time” mean?**

A : “Standing time” means that food should be removed from the oven and covered for additional time to allow it to finish cooking. This frees the oven for other cooking.

*** Q : Why does my oven not always cook as fast as the microwave cooking guide says?**

A : Check your cooking guide again, to make sure you’ve followed directions exactly ; and to see what might cause variations in cooking time. Cooking guide times and heat settings are suggestions, to help prevent over-cooking... the most common problem in getting used to a microwave oven.

Variations in the size, shape and weights and dimensions could require longer cooking time. Use your own judgement along with the cooking guide suggestions to check whether the food has been properly cooked just as you would do with a conventional cooker.

*** Q : Will the microwave oven be damaged if it operates while empty?**

A : Yes. Never run it empty.

*** Q : Can I operate my microwave oven without the turntable or turn the turntable over to hold a large dish?**

A : No. If you remove or turn over the turntable, you will get poor cooking results. Dishes used in your oven must fit on the turntable.

*** Q : Is it normal for the turntable to turn in either direction?**

A : Yes. The turntable rotates clockwise or counterclockwise, depending on the rotation of the motor when the cooking cycle begins.

*** Q : Can I pop popcorn in my microwave oven? How do I get the best results?**

A : Yes. Pop packaged microwave popcorn following manufacture’s guidelines. Do not use regular paper bags. Use the “listening test” by stopping the oven as soon as the popping slows to a “pop” every 1 or 2 seconds. Do not repop unpopped kernels. Do not pop popcorn in glass cookware.

USE YOUR MICROWAVE OVEN SAFELY

General Use

Do not attempt to defeat or tamper with safety interlocks.

Do not place any object between the oven front frame and the door or allow residue to build up on sealing surfaces. Wipe with a mild detergent, rinse and dry.

Never use abrasive powders or pads.

Do not subject the oven door to strain or weight such as a child hanging on an open door.

This could cause the oven to fall forward resulting in injury to you and damage to the oven.

Do not operate the oven if door seals or sealing surfaces are damaged; or if door is bent; or if hinges are loose or broken.

Do not operate the oven empty. This will damage the oven.

Do not attempt to dry clothes, newspapers or other materials in the oven. They may catch on fire.

Do not use recycled paper products as they may contain impurities which may cause sparks or fires. Do not hit or strike the control panel with hard objects. This can damage the oven.

Food

Never use your microwave oven for home canning.

The oven is not designed for proper home canning. Improperly canned food may spoil and be dangerous to consume.

Always use the minimum recipe cooking time. It is better to undercook rather than overcook foods.

Undercooked foods can be returned to the oven for more cooking. If food is overcooked, nothing can be done.

Heat small quantities of food or foods with low moisture carefully. These can quickly dry out, burn or catch on fire.

Do not heat eggs in the shell. Pressure may build up and eggs can explode.

Potatoes, apples, egg yolks and sausages are examples of food with non-porous skins.

These must be pierced before cooking to prevent bursting.

Do not attempt to deep fat fry in your microwave oven.

Always allow a standing time of at least 20 seconds after the oven has been switched off to allow the

temperature to even out, stir during heating, if necessary, and ALWAYS stir after heating. To prevent eruptive boiling and possible scalding, you should put a spoon or glass stick into the beverages and stir before, during and after heating.

Do not leave the oven unattended while popping corn.

Do not pop corn in a paper bag unless it is the commercially prepared Microwave Popcorn product. The kernels can overheat and ignite a brown paper bag.

Do not put packaged Microwave Popcorn bags directly on the oven tray. Place the package on a microwave safe glass or ceramic plate to avoid overheating and cracking the oven tray.

Do not exceed the Microwave Popcorn manufacturers suggested popping time.

Longer popping does not yield more popcorn but it can result in burning the popcorn or risk of fire. Remember, the Popcorn bag and tray can be too hot to handle.

Remove with caution and use pot holders.

ARCING

If you see arcing, touch the STOP/CANCEL pad and correct the problem.

Arcing is the microwave term for sparks in the oven.

Arcing is caused by:

- Metal or foil touching the side of the oven.
- Foil not molded to food (upturned edges act like antennas).

- Metal, such as twist-ties, poultry pins, or gold rimmed dishes, in the microwave.
- Recycled paper towels containing small metal pieces being used in the microwave.



Limited Warranty

MC Appliance Corporation warrants each new Countertop Microwave Oven to be free from defects in material and workmanship, and agrees to remedy any such defect or to furnish a new part(s), at the company's option, for any part(s) of the unit that have failed during the warranty period. Parts and labor expenses are covered on this unit for a period of one year from the date of purchase. A copy of the dated sales receipt or invoice is required to receive warranty service by an authorized service agent.

In addition, MC Appliance Corporation warrants the magnetron (parts only) to be free from defects in material and workmanship for a period of eight years. The consumer is responsible for all labor and transportation expenses related to the diagnosis and replacement of the magnetron after the initial one-year warranty expires. In the event the unit requires replacement or refund under the terms of this warranty, the consumer is responsible for all transportation expenses to return the unit to our factory prior to receiving a replacement unit or refund. A copy of the dated sales receipt/invoice is required to receive warranty service, replacement or refund.

This warranty covers appliances in use within the continental United States, Alaska, Hawaii and Puerto Rico. This warranty does not cover the following:

- Damages due to shipping damage or improper installation.
- Damages due to misuse or abuse.
- Content losses due to failure of the unit.
- Inside components such as turntable, roller guide, light bulbs, etc.
- Repairs performed by unauthorized service agents.
- Service calls that do not involve defects in material and workmanship such as instructions on proper use of the product or improper installation.
- Replacement or resetting of house fuses or circuit breakers.
- Failure of this product if used for other purposes than its intended purpose.
- Disposal costs for any failed unit not returned to our factory.
- Any delivery/installation costs incurred as the result of a unit that fails to perform as specified.
- Expenses for travel and transportation for product service if your appliance is located in a remote area where service by an authorized service technician is not available.
- The removal and reinstallation of your appliance if it is installed in an inaccessible location or is not installed in accordance with published installation instructions.
- Refunds for non repairable products are limited to the price paid for the unit per the sales receipt.

Limitations of Remedies and Exclusions:

Product repair in accordance with the terms herein, is your sole and exclusive remedy under this limited warranty. Any and all implied warranties including merchantability and fitness for a particular purpose are hereby limited to one year or the shortest period allowed by law. MC Appliance Corporation is not liable for incidental or consequential damages and no representative or person is authorized to assume for us any other liability in connection with the sale of this product. Under no circumstances is the consumer permitted to return this unit to the factory without the prior written consent of MC Appliance Corporation.

Some states prohibit the exclusion or limitation of incidental or consequential damages, or limitations on implied warranties. This warranty gives you specific legal rights, and you may also have other rights which vary from state to state.

Model	Parts & Labor	Magnetron (Parts Only)	Type of Service
MCM1611W	One Year	Eight Years	Carry In
MCM1611B			

For Service or Assistance please call **888-775-0202** or visit us on the web at **www.mcappliance.com** to request warranty service or order parts.



**CNA International, Inc. d/b/a MC Appliance Corporation. All rights reserved.
Magic Chef® logo is a registered trademark of CNA International, Inc.**

www.mcappliance.com

Printed in China