

> **IFP52-1C Series**

Commercial Touch Display User Guide

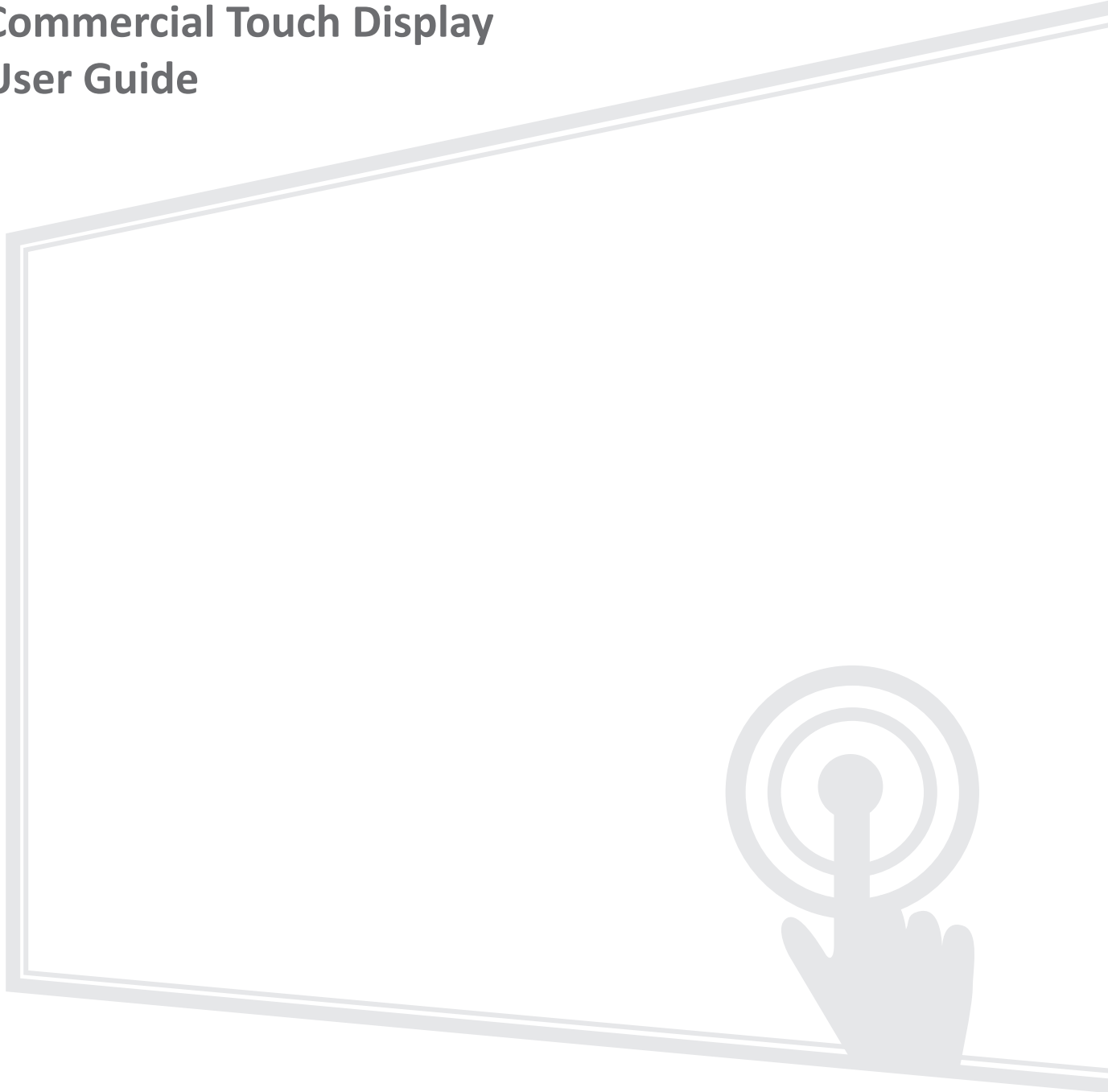

IMPORTANT: Please read this User Guide to obtain important information on installing and using your product in a safe manner, as well as registering your product for future service. Warranty information contained in this User Guide will describe your limited coverage from ViewSonic® Corporation, which is also found on our web site at <http://www.viewsonic.com> in English, or in specific languages using the Regional selection box in the upper right corner of our website.

Model No. VS18786 | VS18789 | VS18791
P/N: IFP6552-1C | IFP7552-1C | IFP8652-1C
IFP6552-1CN | IFP7552-1CN | IFP8652-1CN

Thank you for choosing ViewSonic®

As a world-leading provider of visual solutions, ViewSonic® is dedicated to exceeding the world's expectations for technological evolution, innovation, and simplicity. At ViewSonic®, we believe that our products have the potential to make a positive impact in the world, and we are confident that the ViewSonic® product you have chosen will serve you well.

Once again, thank you for choosing ViewSonic®!

> Safety Precautions

Please read the following **Safety Precautions** before you start using the device.

- Keep this user guide in a safe place for later reference.
- Read all warnings and follow all instructions.
- Do not use the device near water. To reduce the risk of fire or electric shock, do not expose the device to moisture.
- Never remove the rear cover. This display contains high-voltage parts. You may be seriously injured if you touch them.
- Avoid exposing the device to direct sunlight or other sources of sustained heat.
- Do not install near any heat sources such as radiators, heat registers, stoves, or other devices (including amplifiers) that may increase the temperature of the device to dangerous levels.
- Use a soft, dry cloth to clean the external housing. For more information, refer to the "Maintenance" section.
- When moving the device, be careful not to drop or bump the device on anything.
- Do not place the device on an uneven or unstable surface. The device may fall over resulting in an injury or a malfunction.
- Do not place any heavy objects on the device or connection cables.
- If smoke, an abnormal noise, or a strange odor is present, immediately turn the device off and call your dealer or ViewSonic®. It is dangerous to continue using the device.
- The device is a monitor with an LED backlight intended for general office use.
- Do not attempt to circumvent the safety provisions of the polarized or grounding-type plug. A polarized plug has two blades with one wider than the other. A grounding-type plug has two blades and a third grounding prong. The wide blade and the third prong are provided for your safety. If the plug does not fit into your outlet, obtain an adapter and do not attempt to force the plug into the outlet.
- When connecting to a power outlet, DO NOT remove the grounding prong. Please ensure grounding prongs are NEVER REMOVED.
- Protect the power cord from being treaded upon or pinched, particularly at the plug, and at the point where it emerges from the equipment. Ensure that the power outlet is located near the equipment so that it is easily accessible.

- Only use attachments/accessories specified by the manufacturer.
- When a cart is used, use with caution when moving the cart/equipment combination to avoid injury from tipping over.
- Disconnect the power plug from the AC outlet if the device is not being used for a long period of time.
- Place the device in a well-ventilated area. Do not place anything on the device that prevents heat dissipation. Also, avoid any direct lighting.

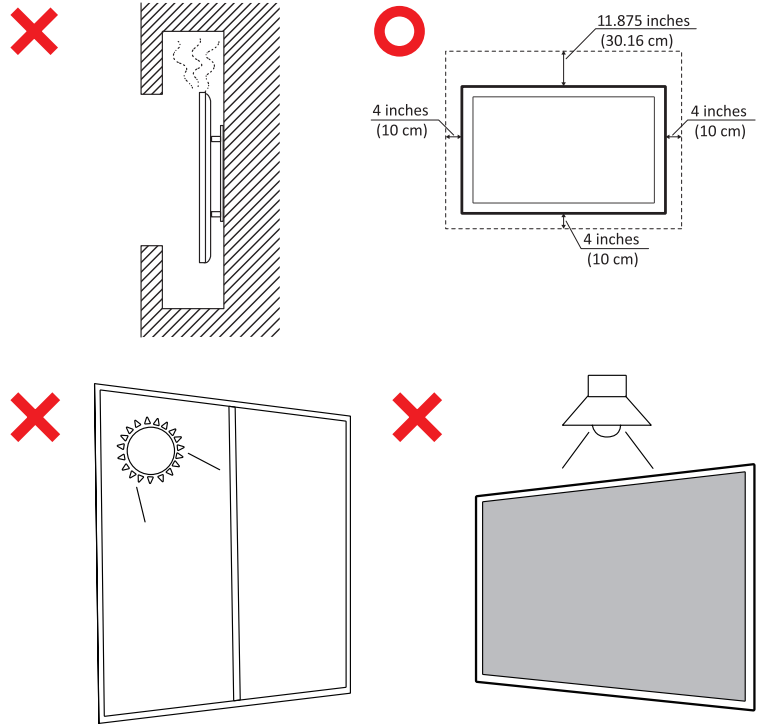

- **CAUTION:**

Immediately unplug your device from the wall outlet and refer servicing to a qualified service personnel under the following conditions:

- » When the power supply cord or plug is damaged.
- » If liquid has been spilled onto or objects have fallen into the unit.
- » If the unit has been exposed to moisture.
- » If the unit does not operate normally or has been dropped.

Never place the device in an unstable location. The device may fall, causing serious personal injury or death. Many injuries, particularly to children, can be avoided by taking simple precautions such as:

- » Using cabinets or stands recommended by the manufacturer of the device.
- » Only using furniture that can safely support the device.
- » Ensuring the device is not overhanging the edge of the supporting furniture.
- » Not placing the device on tall furniture (e.g., cupboards or bookcases) without anchoring both the furniture and the device to a suitable support.
- » Not placing the device on cloth or other materials that may be located between the device and supporting furniture.
- » Educating children about the dangers of climbing on furniture to reach the device or its controls.

If the existing device is going to be retained and relocated, the same considerations as above should be applied.

> Contents

| | |
|--|-----------|
| Safety Precautions..... | 3 |
| Introduction | 10 |
| Package Contents | 10 |
| Wall Mounting Specifications (VESA) | 11 |
| Product Overview | 12 |
| Front Panel | 12 |
| Rear Panel | 12 |
| Control Panel..... | 13 |
| I/O Panels | 14 |
| Remote Control | 16 |
| Using Gestures | 19 |
| Select and Deselect an Object (Clicking) | 19 |
| Display Menu Options (Right-Clicking) | 19 |
| Double-Clicking | 19 |
| Moving an Object | 20 |
| Erasing Digital Ink | 20 |
| Making Connections | 21 |
| Connecting External Devices and Touch Connection | 21 |
| USB Type-C Connection..... | 22 |
| HDMI Connection | 22 |
| VGA Connection | 22 |
| RS-232 Connection | 23 |
| USB and Networking Connections | 24 |
| Media Player Connection | 25 |
| SPDIF Connection | 26 |
| Video Output Connection | 27 |

| | |
|--|-----------|
| Using Your ViewBoard..... | 28 |
| Powering On/Off your ViewBoard..... | 28 |
| Initial Launch Setup | 29 |
| vLauncher - Customizable Welcome Screen..... | 31 |
| vLauncher Message..... | 31 |
| Applications..... | 32 |
| Toolbar | 34 |
| On-Screen Display (OSD) Menu | 40 |
| General Settings | 41 |
| Input Settings | 42 |
| Widget..... | 43 |
| Settings - HDMI & VGA Input Source..... | 44 |
| Audio Settings | 44 |
| Screen Settings..... | 45 |
| Display Settings | 46 |
| Low Blue Light Filter and Eye Health..... | 47 |
| Adjust Settings - (VGA Only)..... | 49 |
| Settings - ViewBoard Player | 50 |
| Wireless & Network | 50 |
| Wi-Fi | 51 |
| Ethernet | 52 |
| Wireless Hotspot..... | 53 |
| VPN..... | 54 |
| Share | 56 |
| SAMBA..... | 56 |
| Display | 58 |
| Wallpaper | 59 |
| Protection..... | 61 |
| HDMI Out | 62 |
| Preference..... | 63 |
| Touch | 64 |
| Language | 64 |
| Keyboard & Input Method | 65 |
| Date & Time | 66 |
| Boot Mode | 67 |
| Startup & Shutdown..... | 68 |
| Toolbar Setting | 69 |

| | |
|---------------------------|----|
| Input Source | 70 |
| Rename Input Source | 71 |
| Source..... | 72 |
| App | 73 |
| APP | 74 |
| System | 76 |
| Clone to USB..... | 77 |
| Display ID..... | 78 |
| Security..... | 79 |
| System Update | 82 |
| About Device | 83 |

Embedded Applications and Settings..... 84

| | |
|--|-----|
| Embedded Digital Whiteboarding App | 84 |
| Whiteboard | 84 |
| ViewBoard Cast | 86 |
| Cast Sender from Windows-based, Macbook, and Chrome devices..... | 87 |
| Cast Sender from Mobile Devices: iOS-based (iPhone, iPad) and Android OS based phone/tablet. | 88 |
| Screen Recorder | 89 |
| Air Class | 90 |
| Voter | 92 |
| Judge | 94 |
| Responder | 95 |
| Selector | 96 |
| Grouping..... | 96 |
| Message | 97 |
| Manager | 97 |
| Exit..... | 97 |
| Other Default Applications | 98 |
| vSweeper..... | 98 |
| Screen Lock | 99 |
| Chromium..... | 100 |
| Folders..... | 101 |

| | |
|--|------------|
| RS-232 Protocol | 103 |
| Description | 103 |
| RS-232 Hardware Specification | 103 |
| LAN Hardware Specification..... | 104 |
| RS-232 Communication Setting..... | 104 |
| LAN Communication Setting | 104 |
| Command Message Reference..... | 104 |
| Protocol | 105 |
| Set-Function Listing..... | 105 |
| Appendix | 110 |
| Specifications..... | 110 |
| Display Modes | 111 |
| VGA Mode | 111 |
| HDMI Mode..... | 111 |
| Type-C Mode | 112 |
| Troubleshooting | 113 |
| Maintenance..... | 115 |
| General Precautions | 115 |
| Cleaning the Screen..... | 115 |
| Cleaning the Case | 115 |
| Regulatory and Service Information | 116 |
| Compliance Information..... | 116 |
| FCC Compliance Statement..... | 116 |
| Industry Canada Statement..... | 117 |
| CAN ICES-003 (A)/NMB-003(A) | 117 |
| CE Conformity for European Countries | 117 |
| Declaration of RoHS2 Compliance..... | 117 |
| ENERGY STAR® statement..... | 118 |
| Indian Restriction of Hazardous Substances | 118 |
| Product Disposal at End of Product Life | 119 |
| Copyright Information | 120 |
| Customer Service | 121 |
| Limited Warranty | 122 |
| Mexico Limited Warranty..... | 125 |

> Introduction

Package Contents

- HDMI cable (10 ft/3 m)
- Power cable
- Remote control
- AAA battery x 2
- USB cable for touch (10 ft /3 m)
- Webcam Plate
- Webcam Screws x 4
(M4x6mm x 2, M3x6mm x 2)
- Compliance Statement
- Touch Pen x 2
- Quick Start Guide
- RS-232 adapter
- Clamp x 5
- USB Type-C cable (5.9 ft /1.8 m)
- Eraser
- Wall Mount Screws x 4
(M8x25mm x 4)

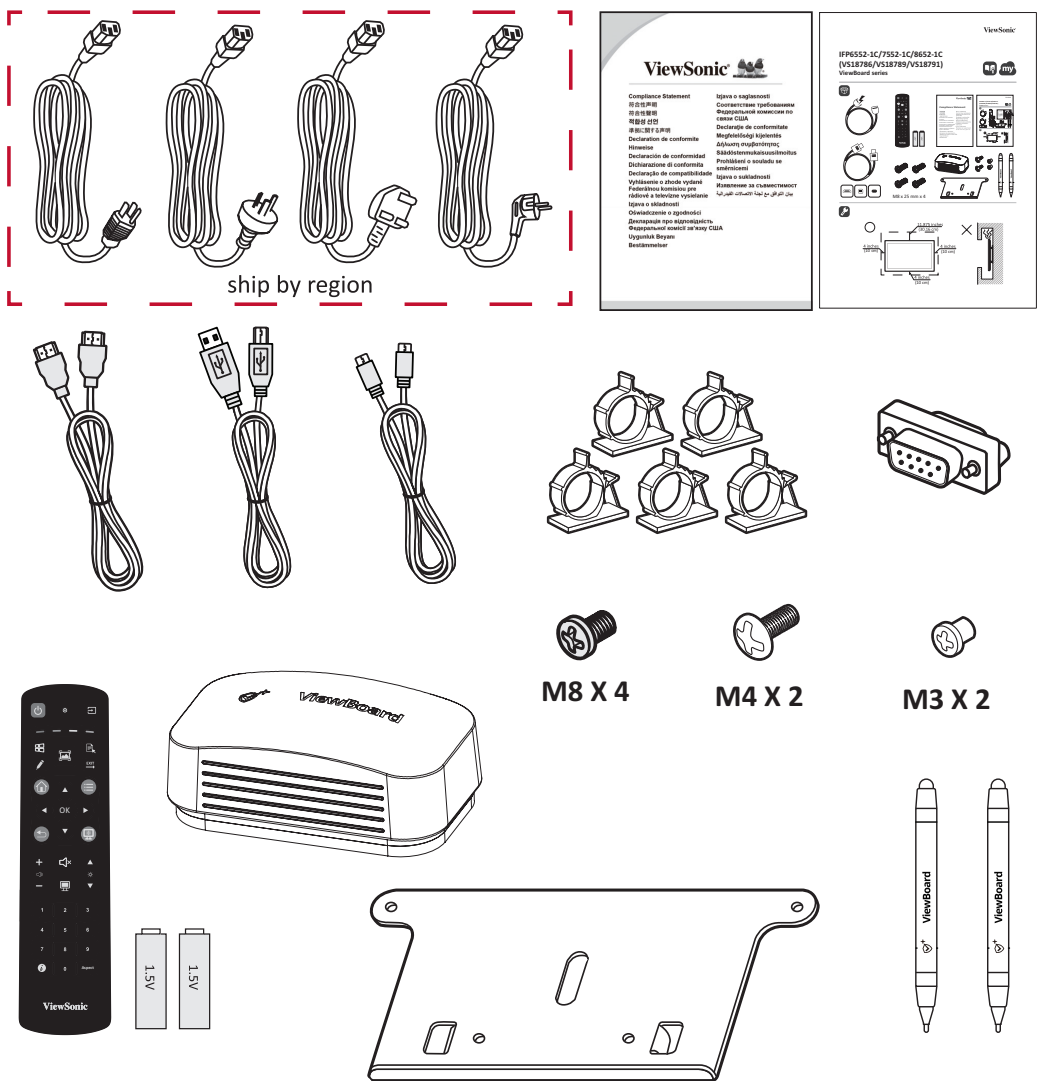

NOTE: The power cord and video cables included in your package may vary depending on your country. Please contact your local reseller for more information.

Wall Mounting Specifications (VESA)

NOTE: Please follow the instructions in the wall mount installation guide to install your wall mount or mobile mount bracket. If attaching to other building materials, please contact your nearest dealer.

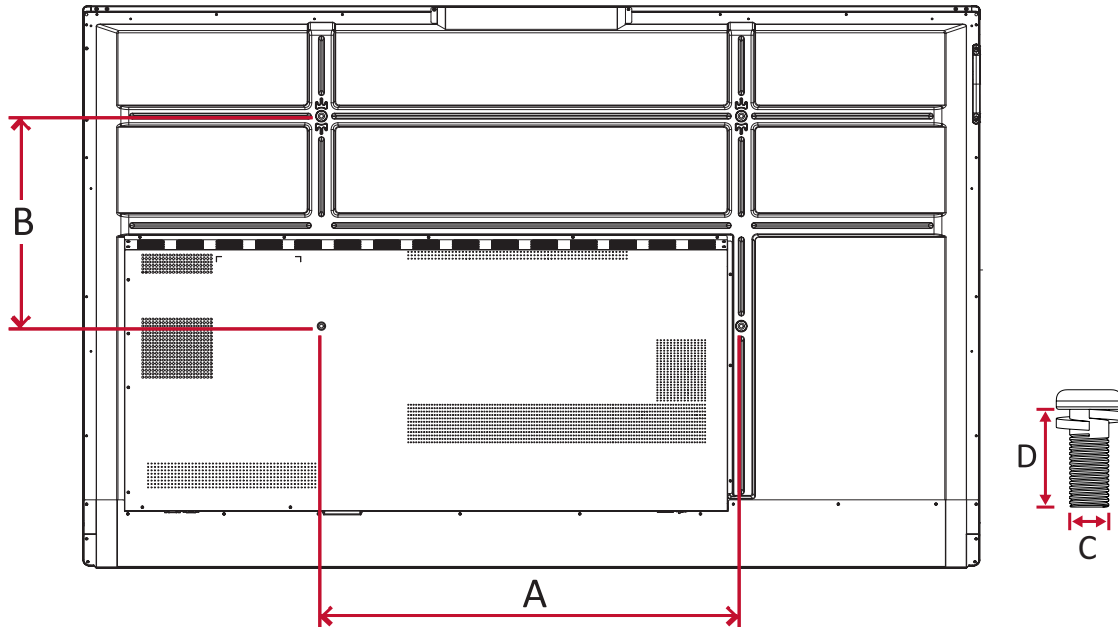

| Model | VESA Spec. (A x B) | Standard Screw (C x D) | Quantity |
|-------------------|--------------------|------------------------|----------|
| IFP6552-1C Series | 600 x 400 mm | M8 x 25 mm | 4 |
| IFP7552-1C Series | 800 x 400 mm | M8 x 25 mm | 4 |
| IFP8652-1C Series | 800 x 600 mm | M8 x 25 mm | 4 |

NOTE: Do not use screws that are longer than the standard dimension, as they may cause damage to the inside of the display.

Product Overview

Front Panel





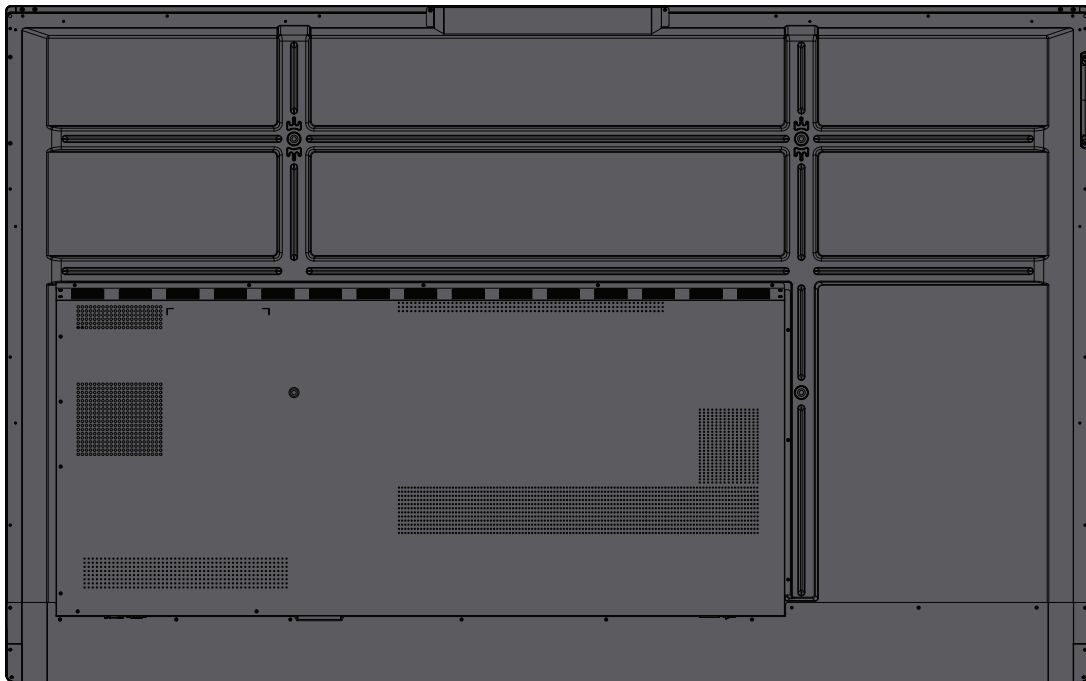



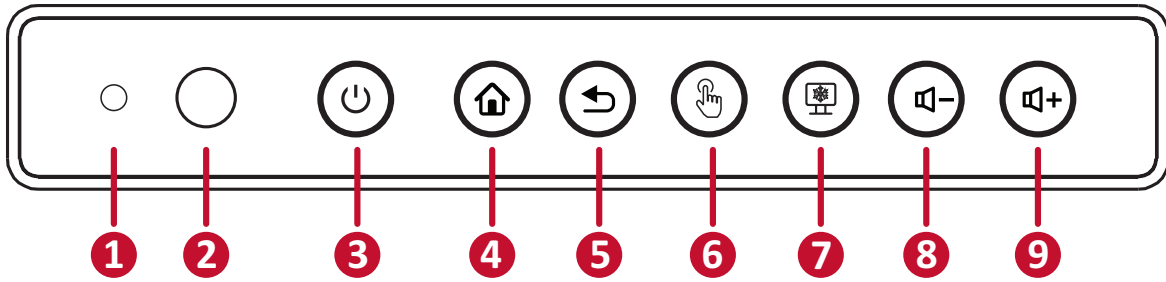

Rear Panel



Control Panel



| Number | Item | Description |
|--------|---|--|
| 1 |  | Ambient Light Sensor to monitor the ambient light |
| 2 |  | Remote control receiver |
| 3 |  | <ul style="list-style-type: none"> • Power indicator light • Press the key to turn on the device • Press the key to turn off/on the display backlight only • Press and hold to turn off the device |
| 4 |  | Back to the ViewBoard player's main interface |
| 5 |  | Return to the ViewBoard player's previous level |
| 6 |  | Disable/enable the touch screen |
| 7 |  | Freeze the current image on the screen |
| 8 |  | Decrease the Volume |
| 9 |  | Increase the Volume |

I/O Panels

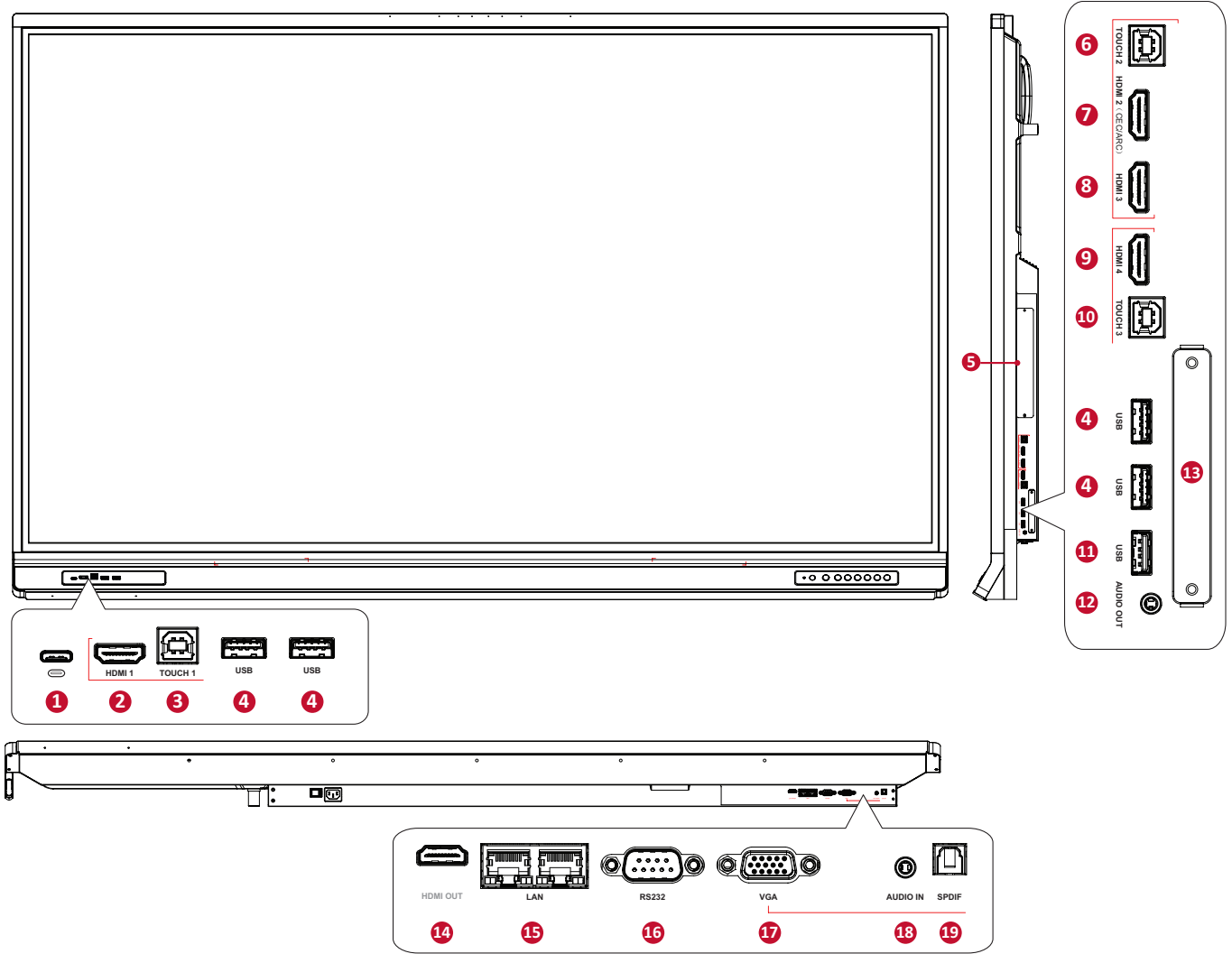

| Number | Port | Description |
|--------|-------------|--|
| 1 | USB Type-C | <ul style="list-style-type: none"> Compatible with USB-C with video IN & data (USB 2.0 data rate). Supports LAN share by 100M. Supports power charge up to 65W. Power charge supported: 5V/3A, 9V/3A, 15V/3A, 20V/3.25A. |
| 2 | HDMI 1 | High definition input; connect to PC with HDMI output, set-top box, or other video device. Supports 4K display. |
| 3 | TOUCH 1 | <ul style="list-style-type: none"> Touch signal output to external PC. After connection (with an external PC), the device connected to the USB 3.0 port can directly be used by the external PC. <p>NOTE: For use with the HDMI 1 port only.</p> |
| 4 | USB 3.0 | Connect USB devices such as hard disks, keyboard, mouse, etc. Automatically switches between PC and ViewBoard. |
| 5 | OPS PC Slot | Supports standard Open Pluggable Specification PC module. |
| 6 | TOUCH 2 | (See TOUCH 1) NOTE: For use with the HDMI 2/3 ports only. |
| 7 | HDMI 2 | (See HDMI 1) NOTE: Supports CEC & ARC. |
| 8 | HDMI 3 | (See HDMI 1) |
| 9 | HDMI 4 | (See HDMI 1) |
| 10 | TOUCH 3 | (See TOUCH 1) NOTE: For use with the HDMI 4 and VGA ports only. |
| 11 | USB | For ViewBoard channel and ViewSonic motorized trolley use only. |
| 12 | AUDIO OUT | Audio output to an external speaker/headset. |
| 13 | Wi-Fi Slot | Compatible with LB-WIFI-001 and VB-WIFI-001 which are designed for ViewBoards and verified by ViewSonic. NOTE: Non-verified Wi-Fi dongles may not be compatible. |
| 14 | HDMI OUT | Connect to devices with HDMI input function. Supports 1080p and 4K@60Hz. Supported by select models. |
| 15 | LAN | Standard RJ45 (10M/100M/1000M) Internet connection interface. Features hub support for network sharing. |
| 16 | RS-232 | Serial interface; used for mutual transfer of data between devices. |
| 17 | VGA | External computer video input. |
| 18 | AUDIO IN | External computer audio input. |
| 19 | SPDIF | Multichannel sound via optical signals. |

Remote Control

| Number | Description |
|--------|--|
| 1 | Power on/off |
| 2 | Screen capture |
| 3 | Startup writing |
| 4 | Back to the ViewBoard player Home Screen |
| 5 | Back/Return to the previous page |
| 6 | Increase/Decrease the Volume |
| 7 | Number Keypad |
| 8 | Information |
| 9 | Input source selection |
| 10 | Media control buttons: <ul style="list-style-type: none"> • Red: Play/Pause • Green: Stop • Yellow: Forwards • Blue: Backwards |
| 11 | Settings menu |
| 12 | Up/Down/Right/Left/OK |
| 13 | Freeze screen |
| 14 | Mute/Unmute |
| 15 | Increase/Decrease Brightness |
| 16 | Blank Screen |
| 17 | Adjust Aspect Ratio |

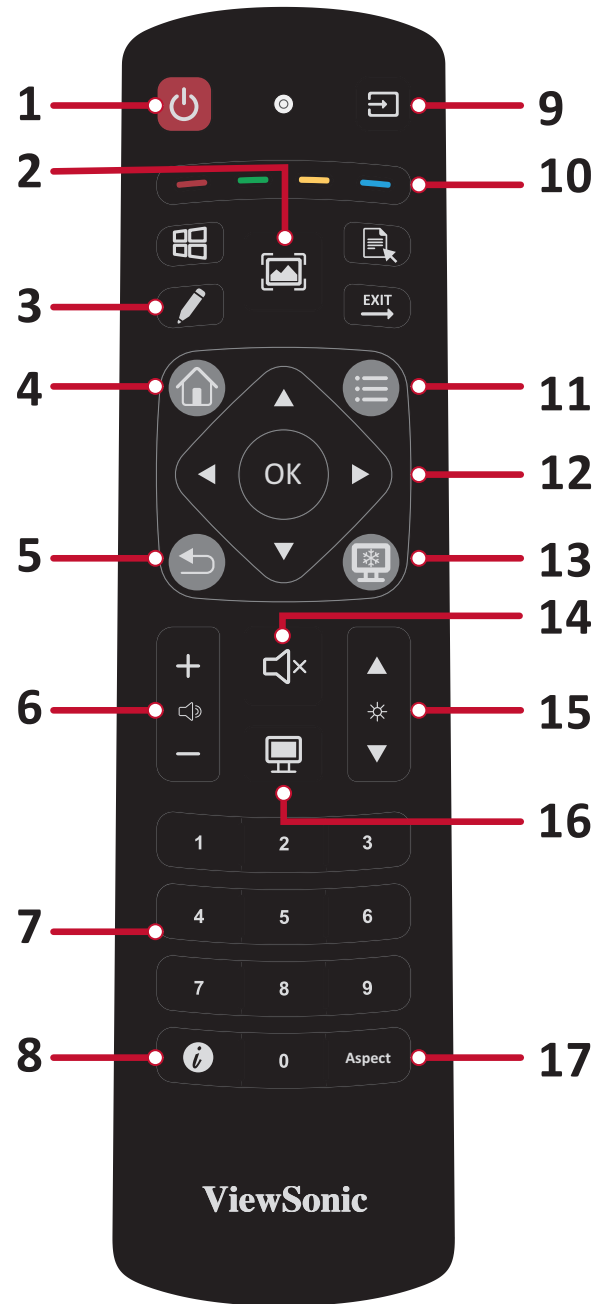

Inserting Remote Control Batteries

To insert batteries into the remote control:

1. Remove the cover on the rear of the remote control.
2. Insert two “AAA” batteries, ensuring the “+” symbol on the battery matches the “+” on the battery post.
3. Replace the cover by aligning it with the slot on the remote control and snapping the latch shut.

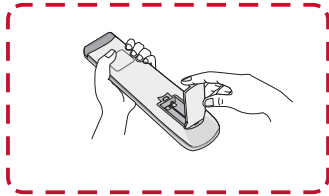

(1)

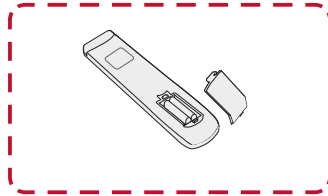

(2)

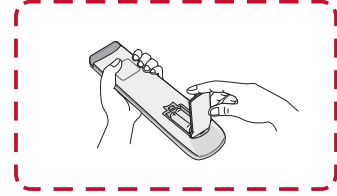

(3)

WARNING: There is a risk of explosion if batteries are replaced with the incorrect type.

NOTE:

- It is recommended that you do not mix battery types.
- Always dispose of old batteries in an environmentally friendly way. Contact your local government for more information on how to dispose of batteries safely.

Remote Control Receiver Range

The working range of the remote control is shown here. It has an effective range of 4 meters, 30° degrees left and right. Ensure there is nothing obstructing the remote control's signal to the receiver.

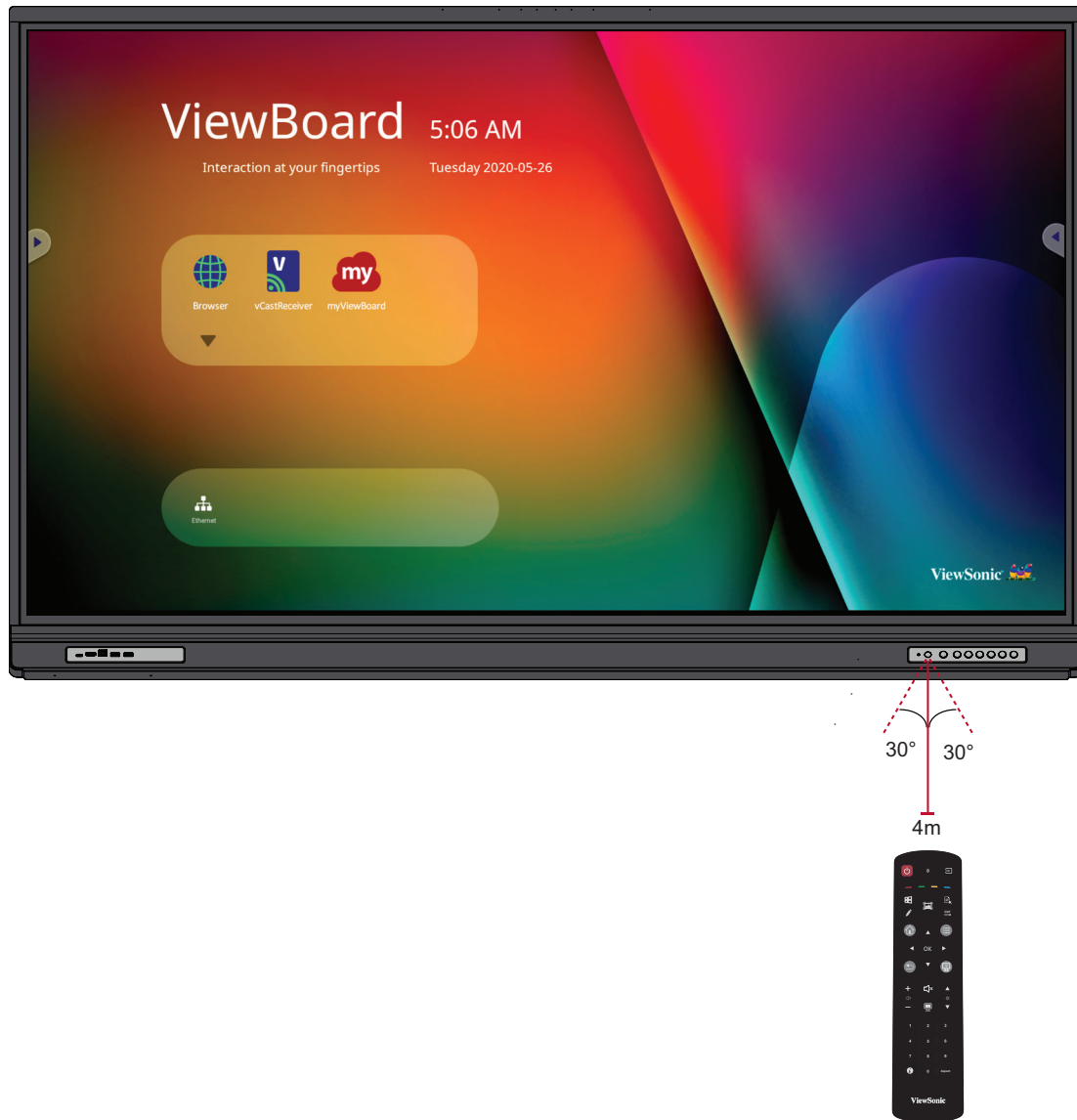

Using Gestures

Touch gestures allow the user to use pre-determined commands without using a keyboard or mouse. Using gestures on the ViewBoard, the user can select/deselect objects, change the location of an object, access settings, erase digital ink, and much more.

Select and Deselect an Object (Clicking)

Press and release the ViewBoard to select/deselect options or objects. This is like a single, standard left mouse click.



Display Menu Options (Right-Clicking)

Press and hold the ViewBoard with your finger. This is like a single, standard right mouse click.



Double-Clicking

Quickly press and release twice in the same location on the ViewBoard. This is like a double, standard left mouse click.



Moving an Object

Press and hold the object on the ViewBoard and slowly drag it with your finger to your desired location.



Erasing Digital Ink

Use your flattened hand, palm, or fist on the ViewBoard and move your hand across the area which you wish to erase.



> Making Connections

Connecting External Devices and Touch Connection



or



TOUCH



HDMI

or



TOUCH

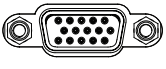

VGA

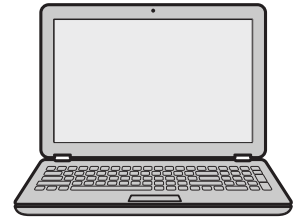

Computer

Your external device(s) can be connected in any of the following configurations:

USB Type-C Connection

To connect via USB Type-C:

Connect a USB Type-C cable from your external device to the **Type-C** port on the ViewBoard.

HDMI Connection

To connect via HDMI:

1. Connect an HDMI cable from your external device to the **HDMI** port on the ViewBoard.
2. Connect a USB cable to the external device from the **TOUCH** port of the ViewBoard.

NOTE: The **TOUCH 1** port is for the **HDMI 1** port. The **TOUCH 2** port is for the **HDMI 2 & 3** ports. The **TOUCH 3** port is for the **HDMI 4** port.

VGA Connection

To connect via VGA:

1. Connect a VGA cable from your external device to the **VGA** port on the ViewBoard.
2. Connect a USB cable to the external device from the **TOUCH** port of the ViewBoard.

NOTE: The **TOUCH 3** port is for the **VGA** port.

RS-232 Connection

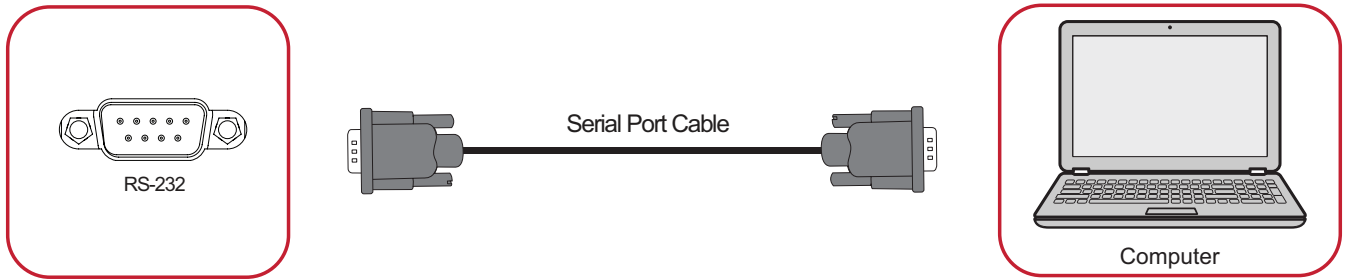

When you use a RS-232 serial port cable to connect your display to an external computer certain functions can be controlled remotely by the PC, including Power On/Off, Volume adjustment, Input select, Brightness, and more.

USB and Networking Connections

Just like any PC, it is easy to connect various USB devices and other peripherals to your ViewBoard.

USB Peripherals

Plug the USB device cable into the **USB** port.

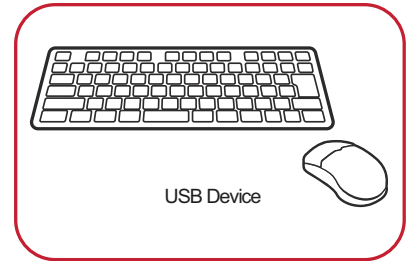
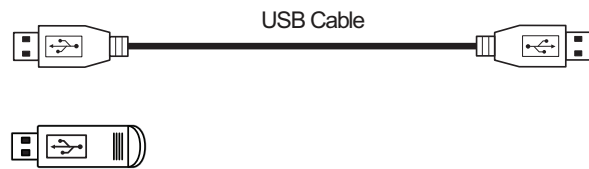
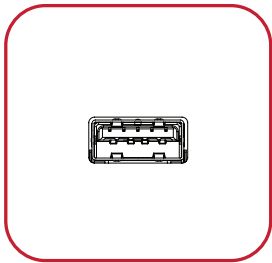

Networking and Modem cables

Plug the network cable into the **LAN** port.

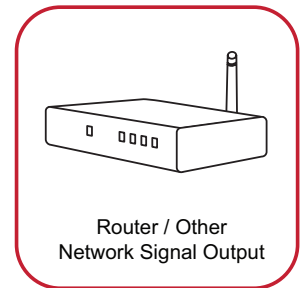
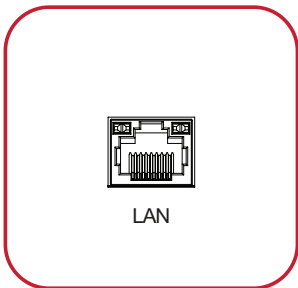

Media Player Connection

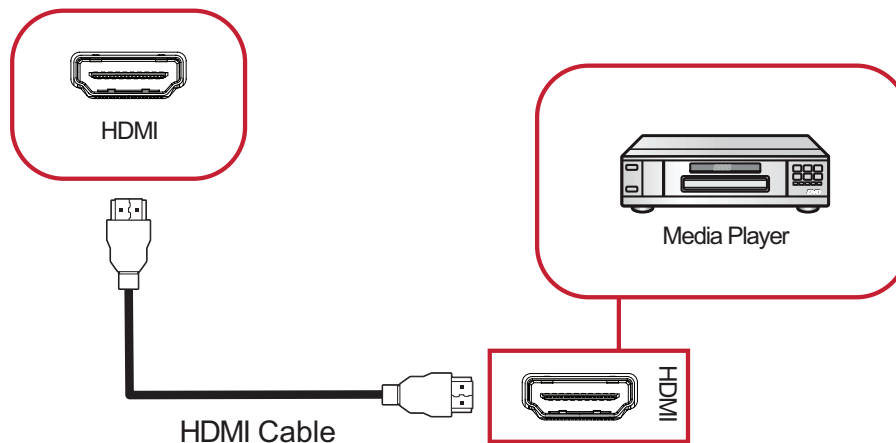

To connect to a media player:

1. Connect the HDMI cable to the **HDMI** ports on your ViewBoard and peripheral device.
2. Plug in the power cord of your ViewBoard, and turn on the power supply switch.
3. Press the **Power** button on the right-hand side of the ViewBoard to turn the screen on.
4. Press the **INPUT** button on the remote control and switch to the "HDMI" input source.

SPDIF Connection

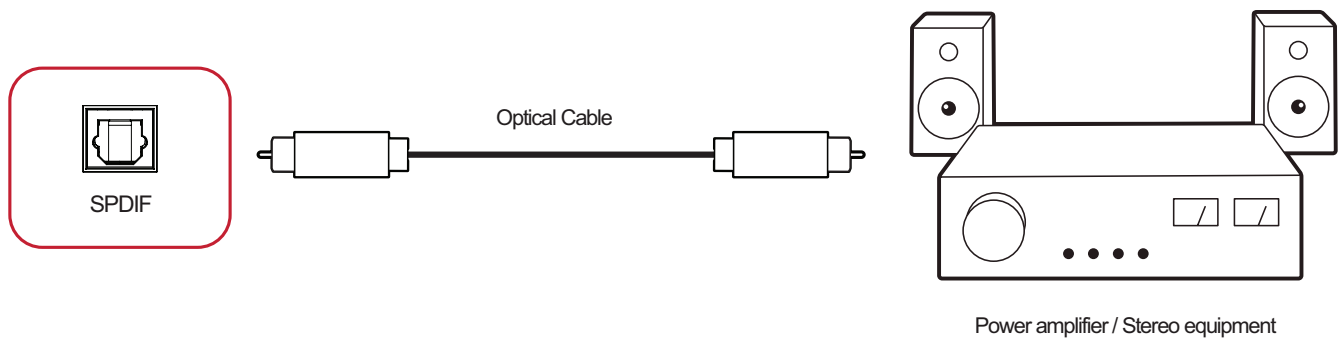

To connect to an external sound system:

1. Connect an optical cable from the **SPDIF** port to your sound system's optical connector.
2. Plug in the power cord of your ViewBoard, and turn on the power supply switch.
3. Press the **Power** button on the right-hand side of the ViewBoard to turn the screen on.

Video Output Connection

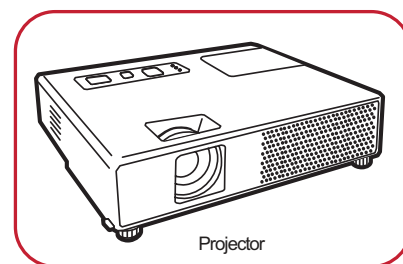
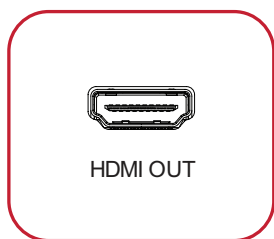

To output video via a display device:

1. Connect an HDMI cable to the **HDMI IN** port of your display device, and the other end to the **HDMI OUT** port of your ViewBoard.
2. Plug in the power cord of your ViewBoard, and turn on the power supply switch.
3. Press the **Power** button on the right-hand side of the ViewBoard to turn the screen on.



> Using Your ViewBoard

Powering On/Off your ViewBoard

1. Ensure the power cord is connected, plugged into a power outlet, and the power switch is in the “On” position.

NOTE: The AC IN socket and Power Switch are located at the bottom of the device.



2. Press the  Power button to turn on the ViewBoard.
3. To turn the ViewBoard off, press and hold the  Power button.

Initial Launch Setup

When you first turn on your ViewBoard, an initial setup wizard will launch.

1. Select your Language:

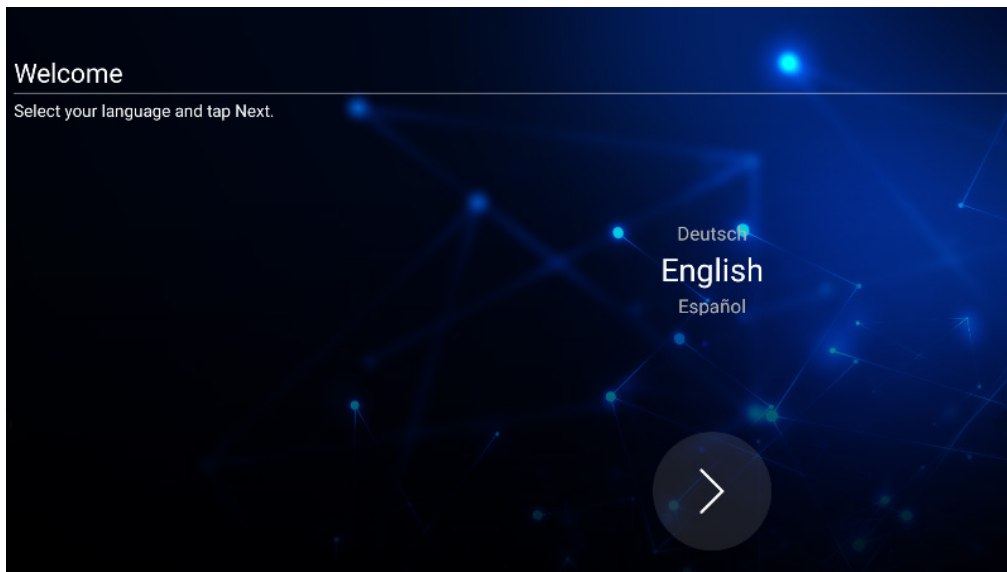

2. Setup and verify your LAN connection:

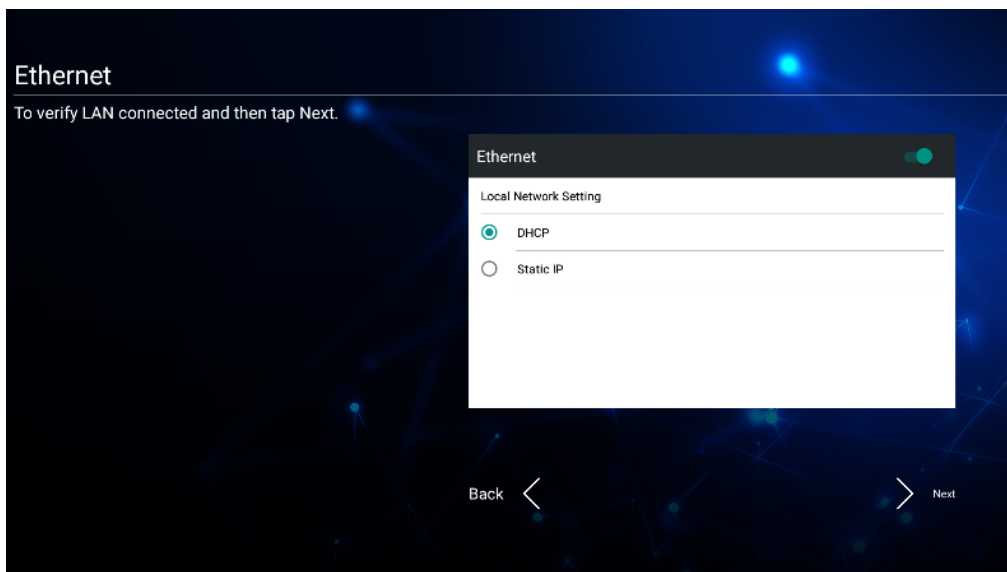

3. Select your Time Zone to set the Date and Time:

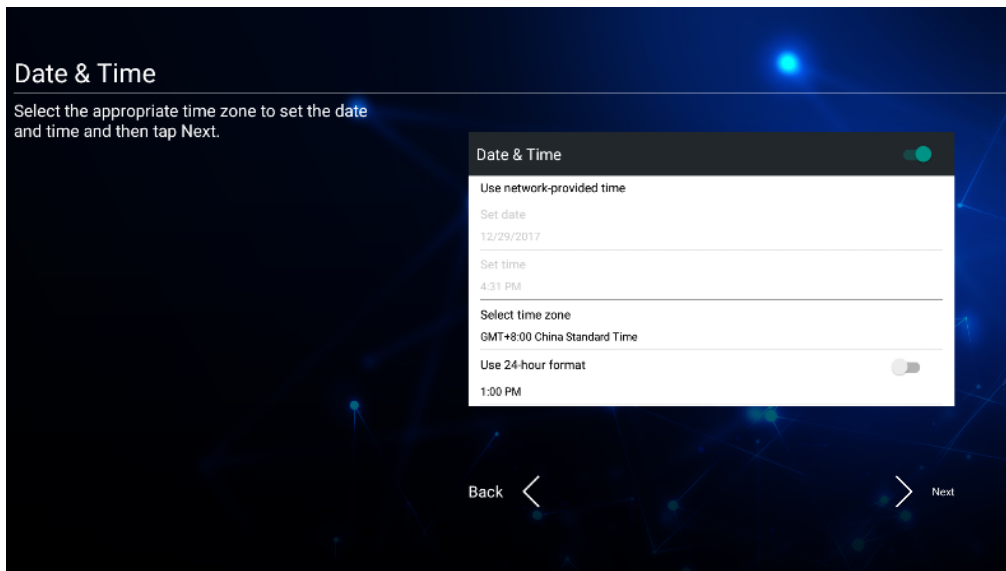

4. Select your preferred System Mode:

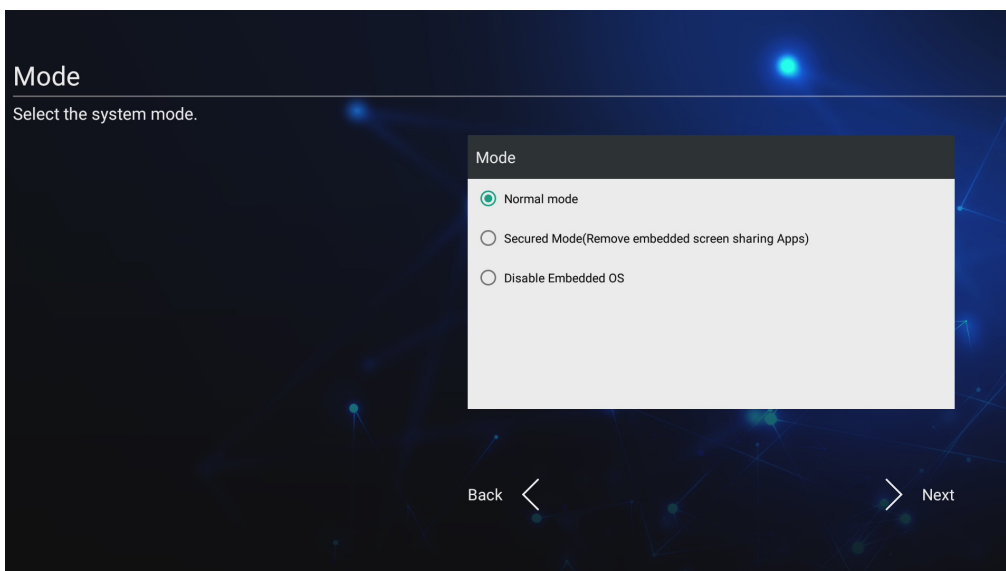

5. Accept or Decline the Privacy and Copyright Protection Terms.

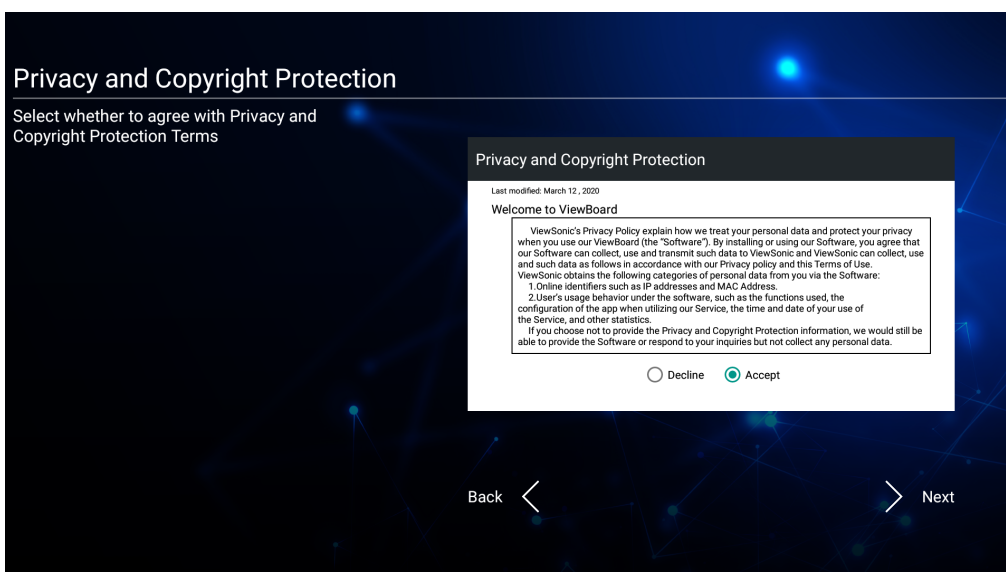

vLauncher - Customizable Welcome Screen

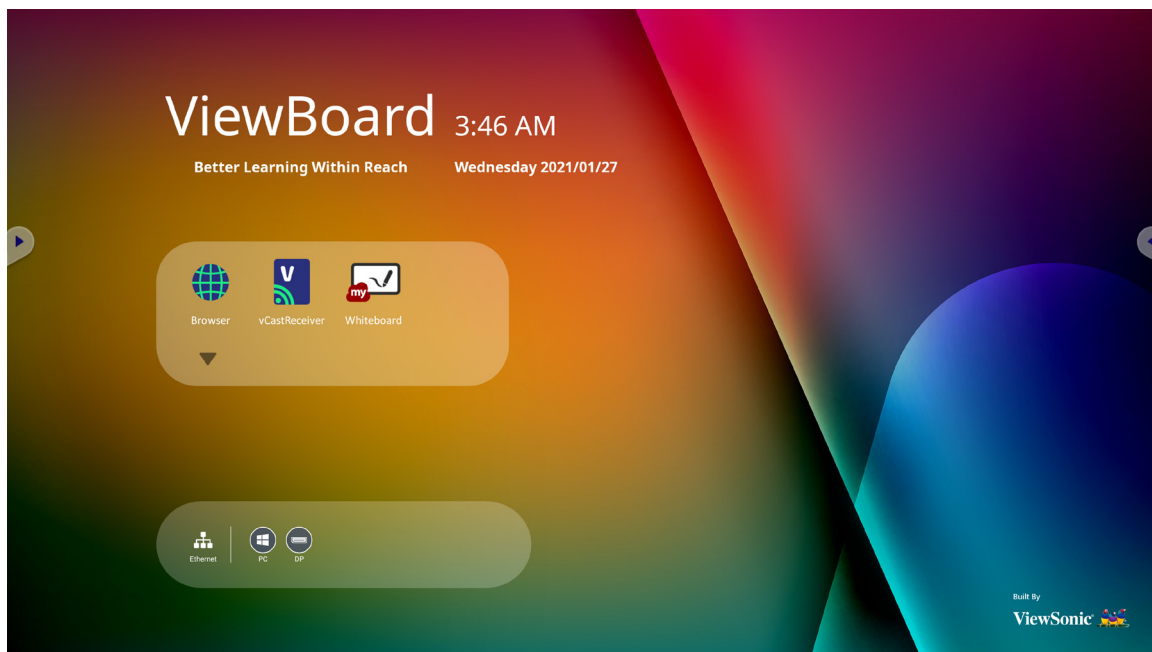

vLauncher Message

Both the vLauncher **Title** and **Subtitle** can be customized by tapping on them.



Additionally, a password can be set by tapping on **Set Password**.

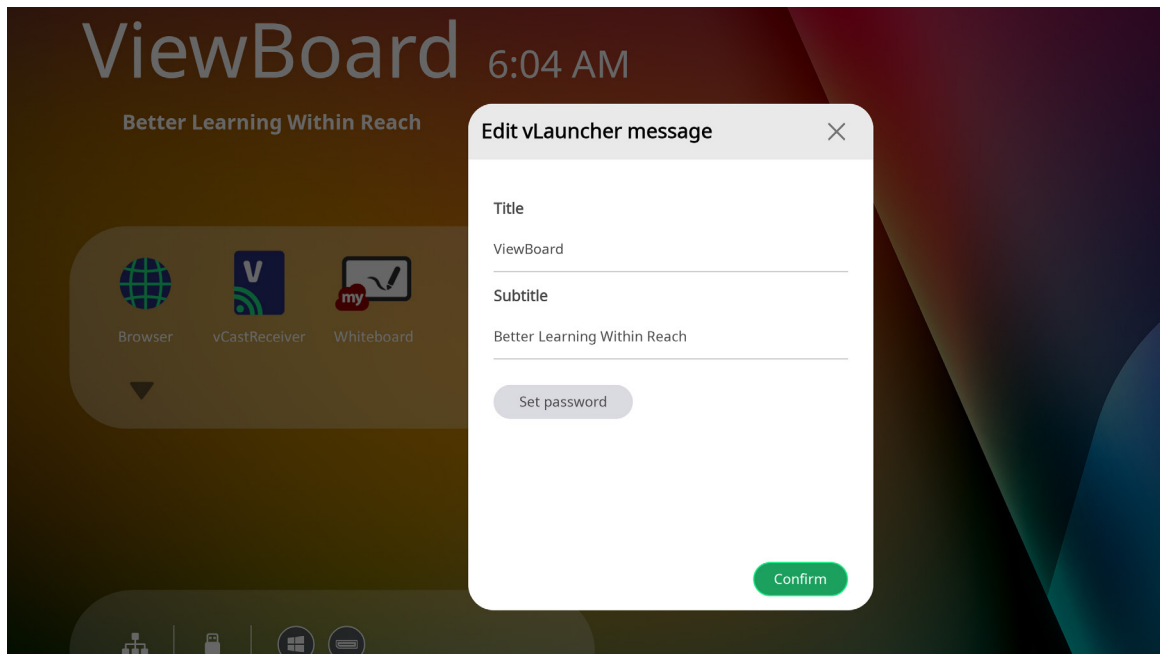

Applications

Installed applications can all be found on the welcome screen. To view all applications tap on the **Down Arrow**.

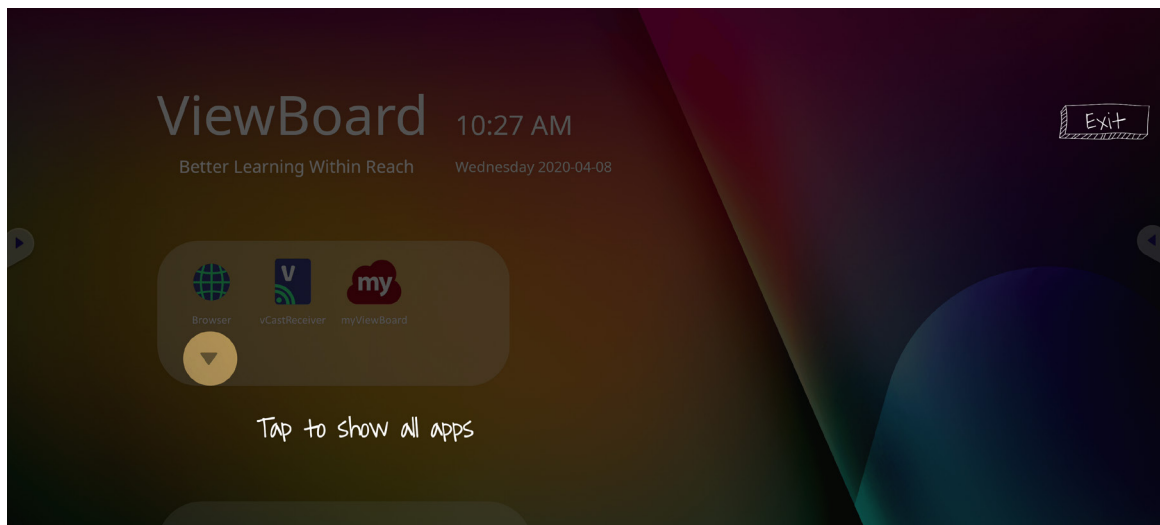

To hide the application drawer tap the **Up Arrow**.

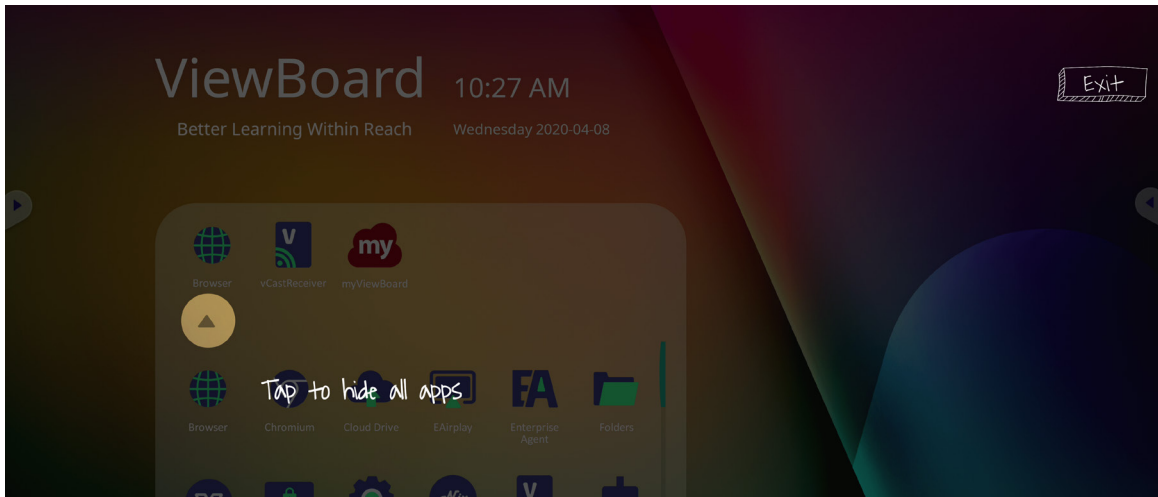

To add a shortcut to an application, tap, hold, and drag up the icon.

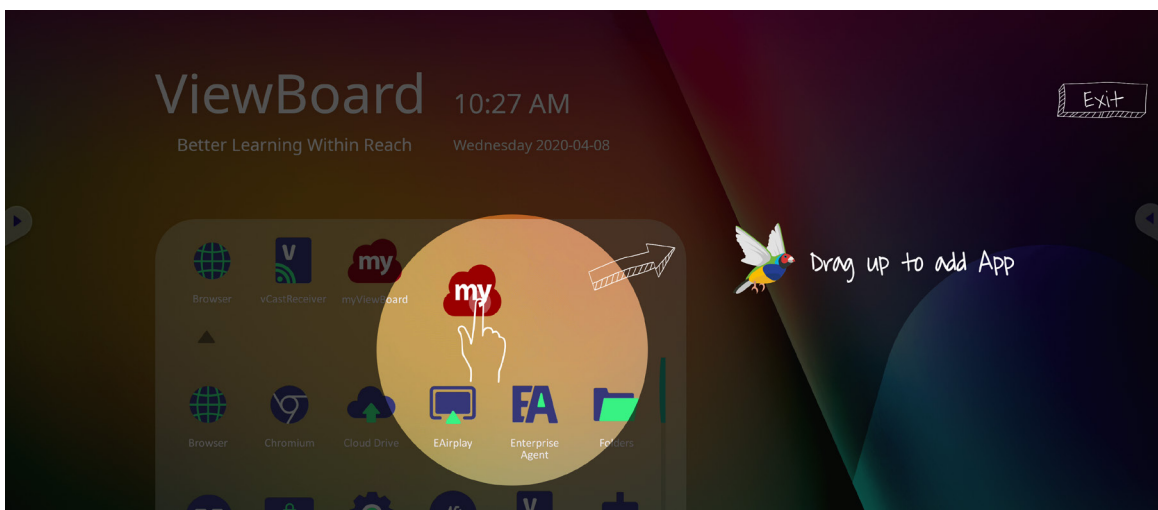

To remove an application shortcut, tap, hold, and drag the icon down.

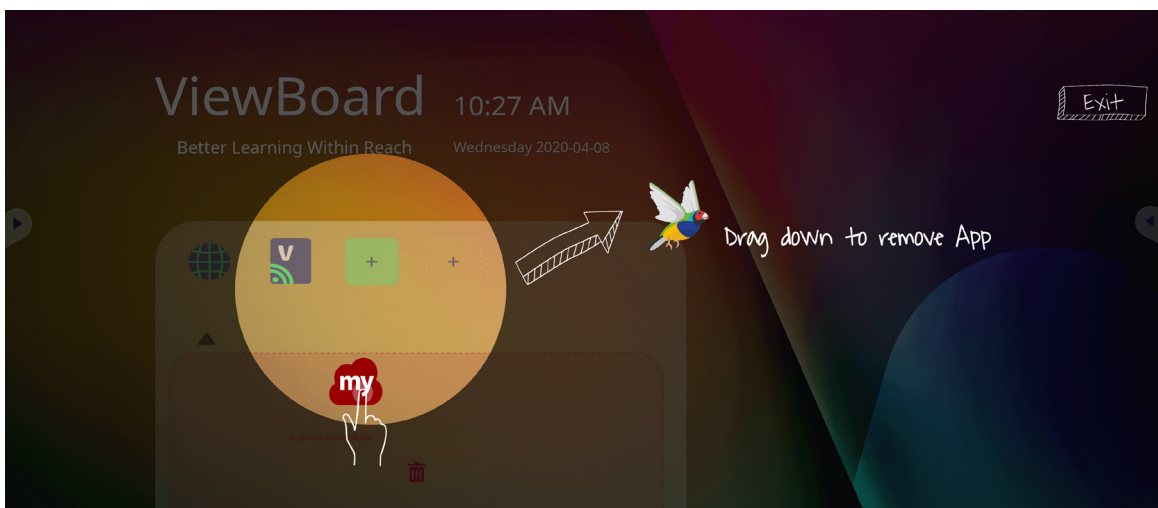

Toolbar

Toolbar trigger icons are on the edge of the ViewBoard launcher providing access to your tools.

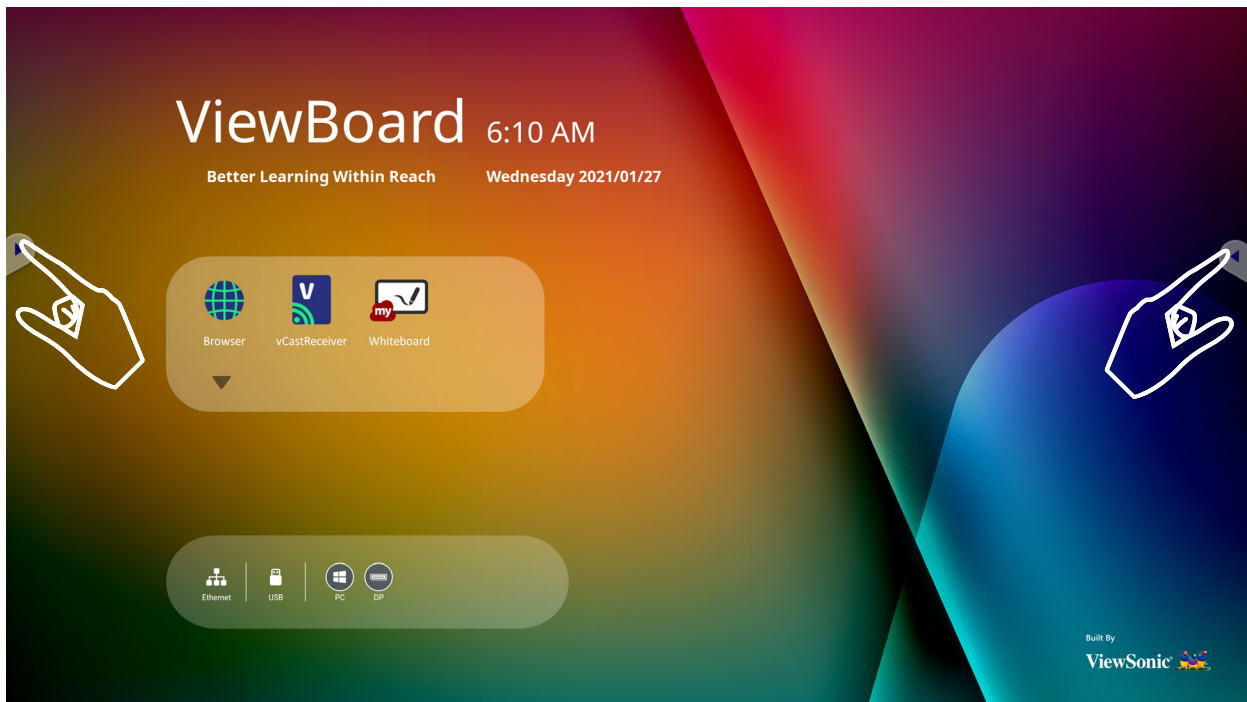















To launch a tool:





1. Tap a Toolbar trigger icon.
2. Tap on your desired tool icon.



NOTE: The default toolbar setting is to be available for all input sources; however, users can go to: **Settings > Preference > Toolbar setting** to adjust the options: (1) available for all input sources, (2) hide the toolbar for all input sources.

| Icon | Description |
|---|---|
|  Back | Return to the previous operation screen. NOTE: Only for the Embedded Player source. |
|  Home | Return to the Home Screen of the Embedded Player. |
|  Recent | Display all embedded applications that are currently being used. |
|  App | View all installed applications. |
|  Whiteboard | Launch the Whiteboard software. |
|  Recorder | Record, view, and save the on-screen content. |

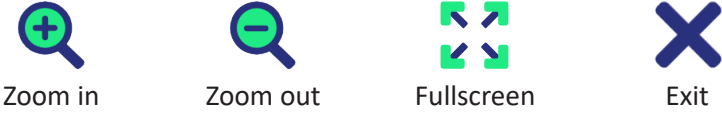
| Icon | Description |
|--|---|
| | <p>Access the pen, highlighter, clear, and save options.</p> <div style="display: flex; justify-content: space-around; align-items: center;"> <div style="text-align: center;">  Pen </div> <div style="text-align: center;">  Highlighter </div> <div style="text-align: center;">  Eraser </div> <div style="text-align: center;">  Undo </div> </div> <div style="display: flex; justify-content: space-around; align-items: center; margin-top: 10px;"> <div style="text-align: center;">  Redo </div> <div style="text-align: center;">  Clean </div> <div style="text-align: center;">  Save </div> <div style="text-align: center;">  Exit </div> </div> |
|  Draw | <p><u>Pen</u></p> <p>Annotate the overlay of any input source with black, white, yellow, orange, red, pink, green, or blue ink.</p> <p>NOTE: The default pen setting supports up to 10-point writing.</p> |
| | <p><u>Highlighter</u></p> <p>Mark and highlight with yellow, grey, gold, orange, red, pink, green or blue ink.</p> <p>NOTE: The default highlighter setting supports up to 10-point marking.</p> |
| | <p><u>Eraser</u></p> <p>Selectively remove the digital ink on the screen.</p> |
| | <p><u>Undo</u></p> <p>Undo the previous action.</p> |
| | <p><u>Redo</u></p> <p>Redo the previous action.</p> |
| | <p><u>Clean</u></p> <p>Clears all the digital ink on the screen.</p> |
| | <p><u>Save</u></p> <p>Save the screen image and any annotations.</p> |
| | <p><u>Exit</u></p> <p>Close the drawing tool.</p> |

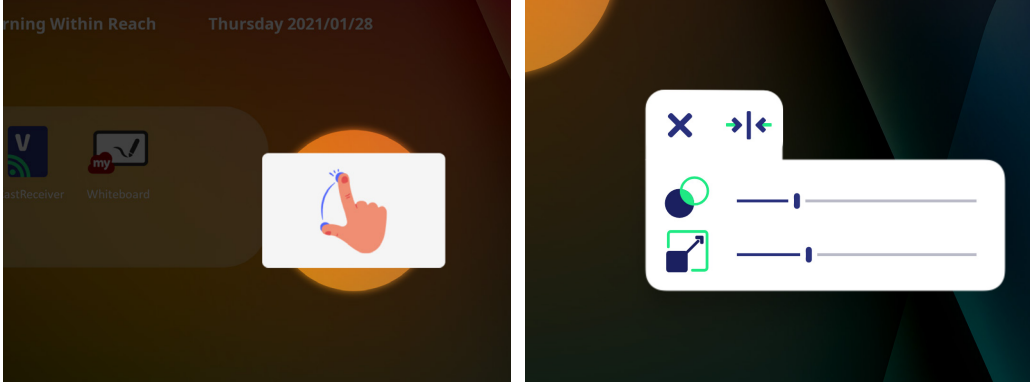
| Icon | Description |
|---|---|
|  | <p>View more applications within the ViewBoard tool bar.</p>  <p>Screen Freeze Spotlight Stopwatch Timer Hide/Unhide Screen Capture</p> |
| | <p><u>Screen Freeze</u> </p> <p>Convert the currently displayed content into a still image; then you can zoom in, zoom out, go back to full screen, and exit.</p>  <p>Zoom in Zoom out Fullscreen Exit</p> |
| | <p><u>Spotlight</u> </p> <p>Highlight the focus content zone. Tap the Setting icon to adjust the spotlight size and alpha blending effect.</p>  |

Icon

Description

Stopwatch

Tapping **Start** will initiate the stopwatch.

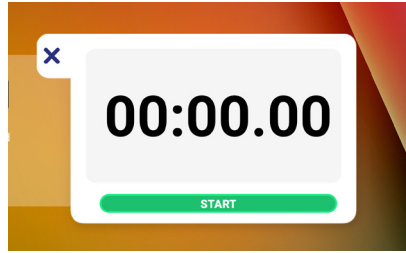

At any time, the stopwatch can be paused, resumed, split, or reset.

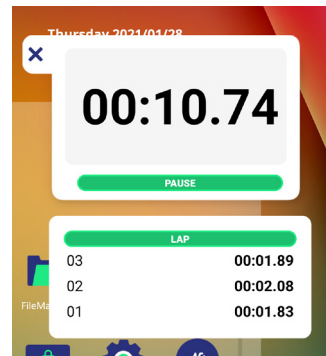
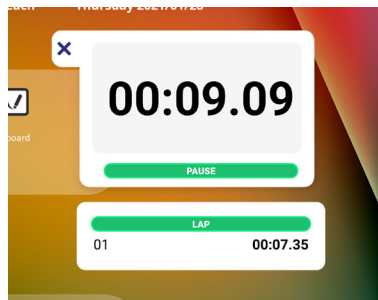

More

Timer

Access the countdown timer with an optional alarm setting. Touch and swipe to adjust the numeric values, then click **Start**.

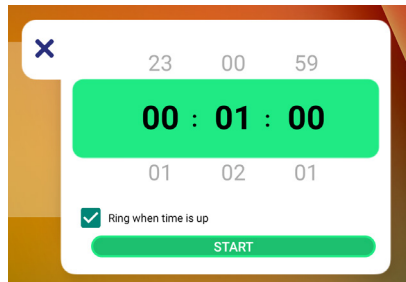

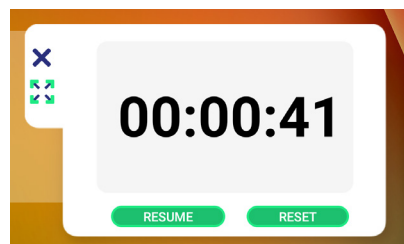
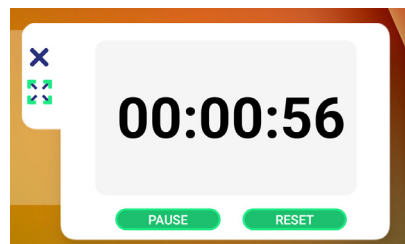

At any time, the countdown timer can be paused, resumed, or reset.



Hide/Unhide

Hide or unhide the Tool bar trigger icons.

| Icon | Description |
|---|---|
|  More | <u>Screen Capture</u>  Take a screenshot of the current screen. |
|  Settings | Access the General Settings. |

On-Screen Display (OSD) Menu

Access General Settings, Input Settings, and Widgets through the OSD Menu.

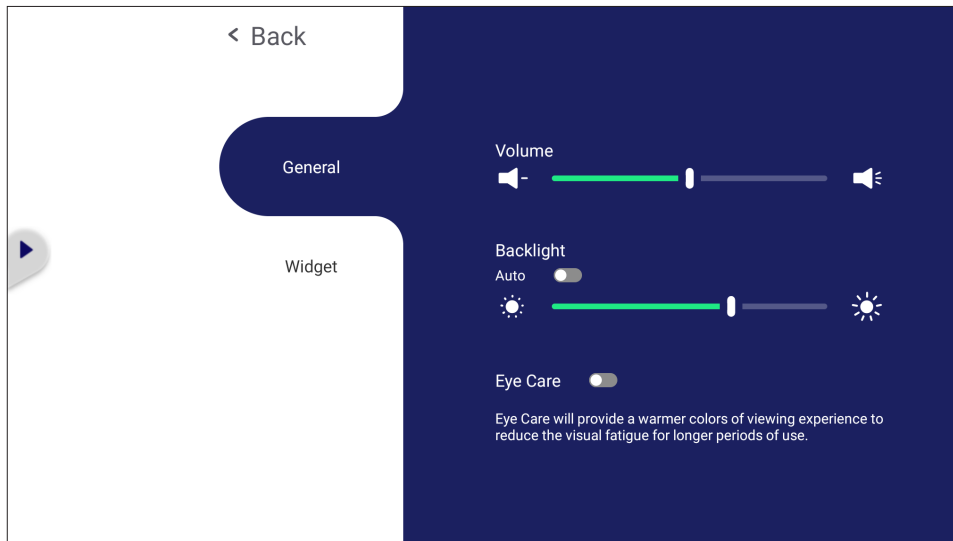

ViewBoard has two options for opening the OSD Menu:

Option 1

Long press anywhere in the vLauncher background.

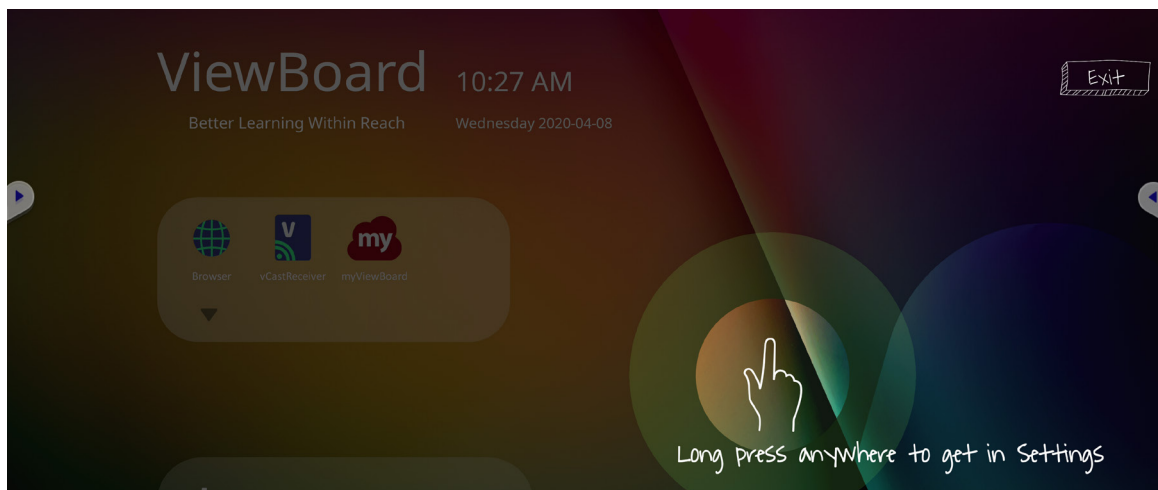

Option 2

Press the **INPUT** button on the remote control.



General Settings

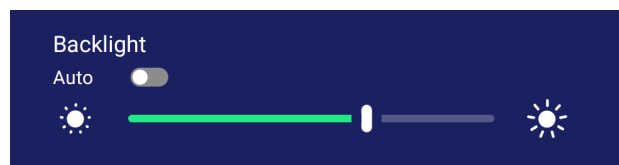



To adjust the Backlight:

1. Press **INPUT** on the remote control or long press the vLauncher background and touch **General** on-screen (if needed) to display the **General Settings** menu.
2. Drag the brightness slider directly to adjust the backlight value, and/or touch On or Off to enable/disable the function.
3. Press  on the remote control, or touch a blank area outside of the menu to exit.





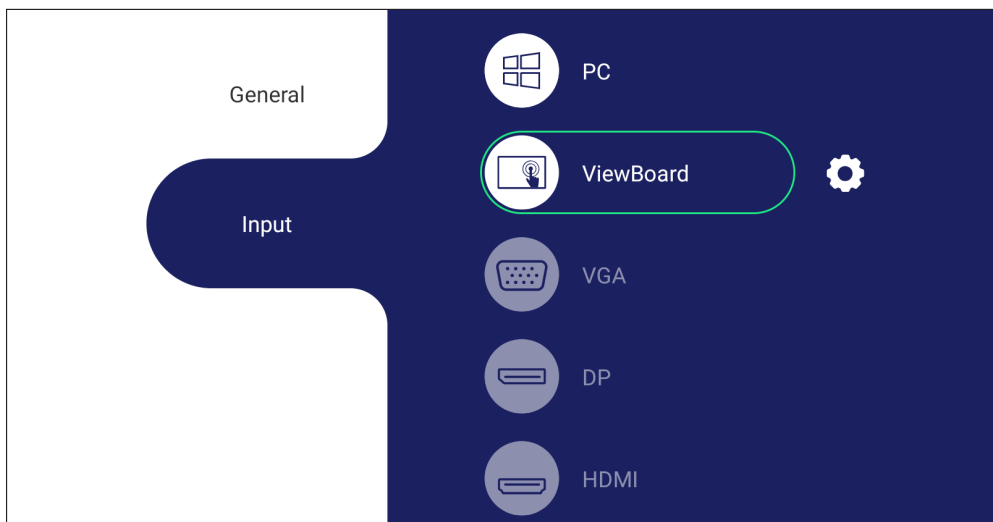

To adjust the Volume:

1. Press **INPUT** on the remote control or long press the vLauncher background and touch **General** on-screen (if needed) to display the **General Settings** menu.
2. Drag the volume slider directly to adjust the value.
3. Press  on the remote control to enable or disable the mute function.
4. Press  on the remote control, or touch a blank area outside of the menu to exit.

Input Settings



To select an Input Source:

1. Press **INPUT** on the remote control, press the setting button  on the front panel, or press the  setting icon from the toolbar to display the **Input Settings** menu.
2. Press **▼/▲/◀/▶** to select the input source you want.
NOTE: PC source will only display when the slot-in computer is connected.
3. Press  on the remote control, or touch the input source.
4. Press  on the remote control, or touch a blank area outside of the menu to exit.

NOTE: To adjust the settings of an input source, touch the setting icon next to the highlighted input source.

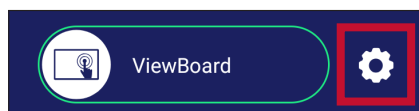

Widget

NOTE: Only available for the ViewBoard Player source.

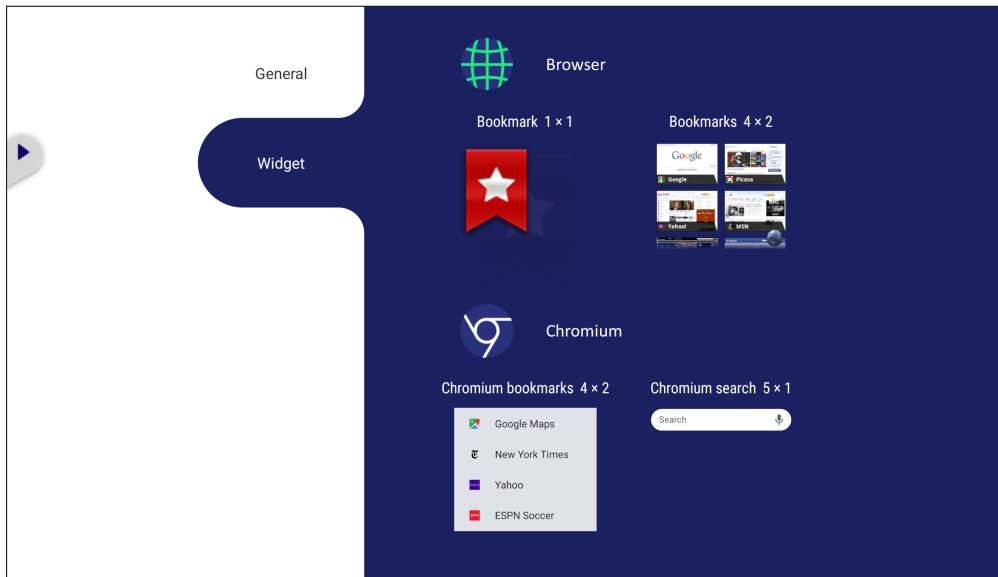

To add a widget to the vLauncher welcome screen:

1. Long press the vLancher background via touch to launch the OSD Menu.



2. Select **Widget**.

3. Touch and hold the desired widget.

4. Drag the widget onto the vLauncher background.

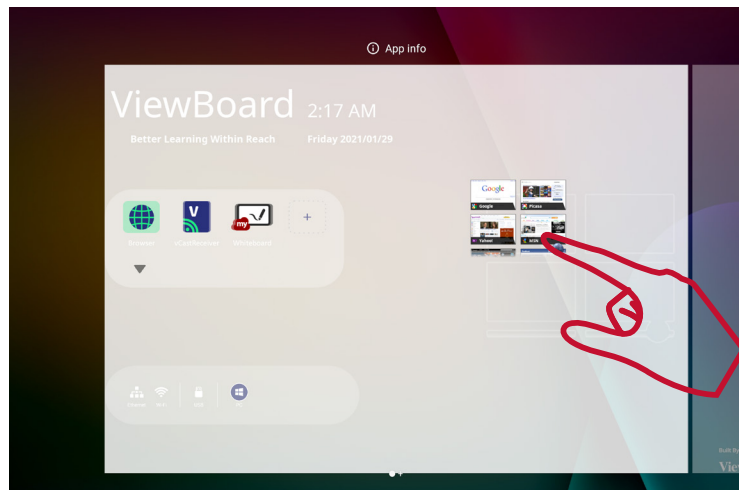

Settings - HDMI & VGA Input Source

Press **MENU** on the remote control or select the setting icon next to the input source in **Input Settings** to launch the **Settings** menu. Settings include: **Audio**, **Screen**, **Display**, and **Adjust**.

Audio Settings

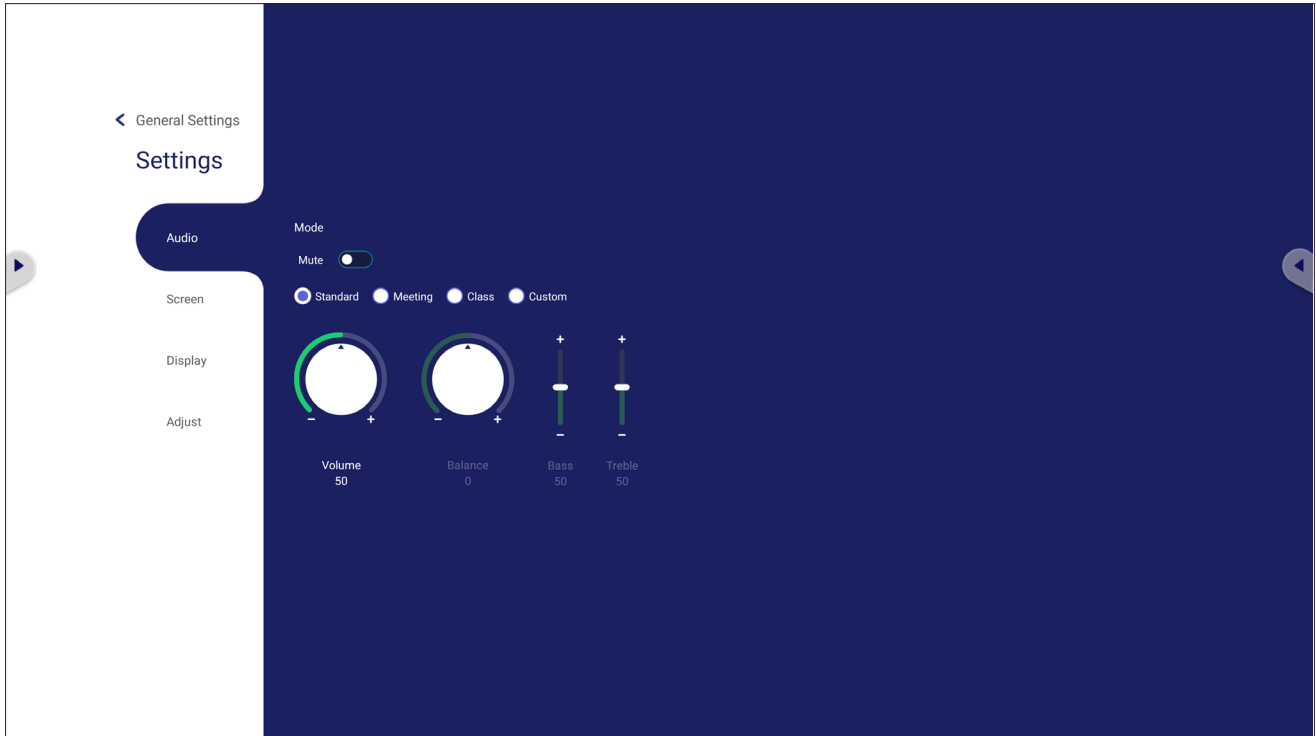

1. Press ▼ on the remote control and select the **Audio** menu.
2. Press ▼/▲/◀/▶ on the remote control or directly touch the option to select it.
3. Adjust the Volume, Bass, Treble, and Balance directly by touching and adjusting each value, or with the remote control by pressing (OK) to adjust the option.
4. Touch the Mute slider directly to enable/disable mute, or press 🔊x on the remote control.
5. Press (↩) on the remote control, or touch a blank area outside of the menu to exit.

Screen Settings

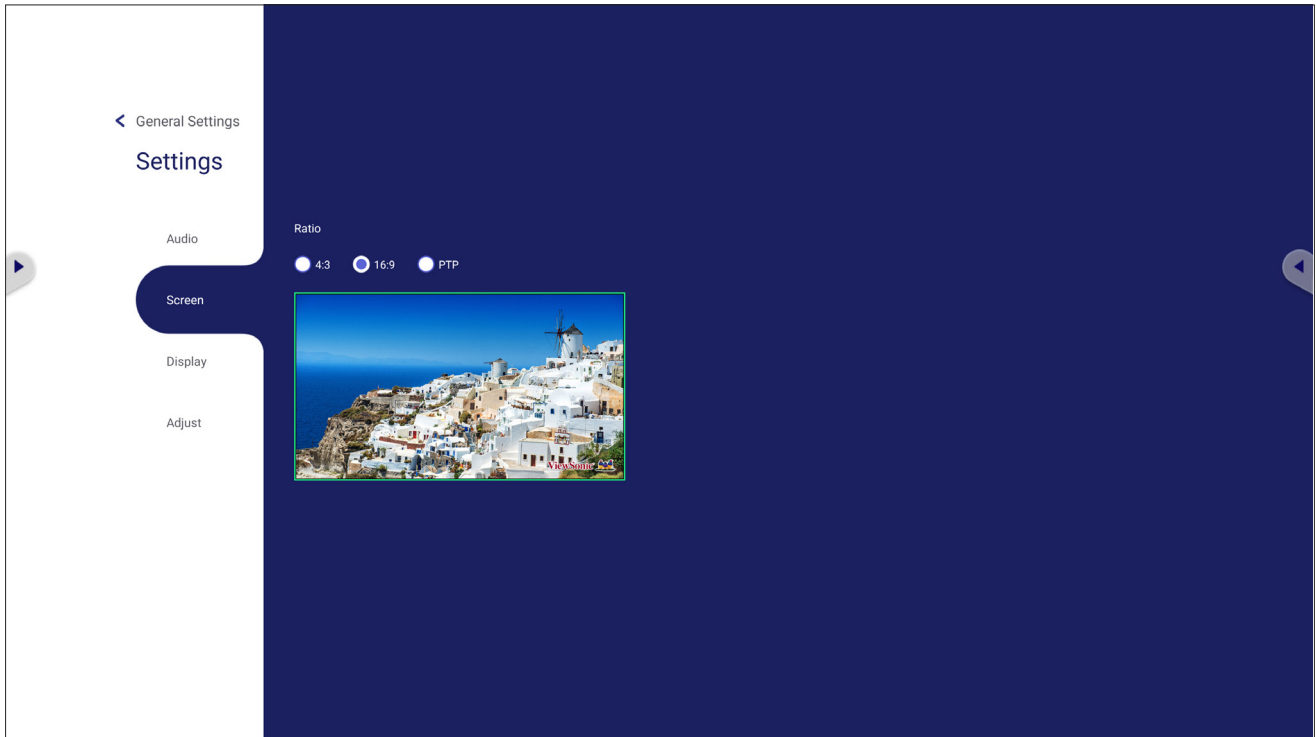

1. Press ▼ on the remote control and select the **Screen** menu.
2. Press ▼/▲/◀/▶ on the remote control or directly touch the option to select it.
3. Adjust your preference by touching each value directly, or with the remote control by pressing (OK).
4. Press (Back) on the remote control, or touch a blank area outside of the menu to exit.

Display Settings

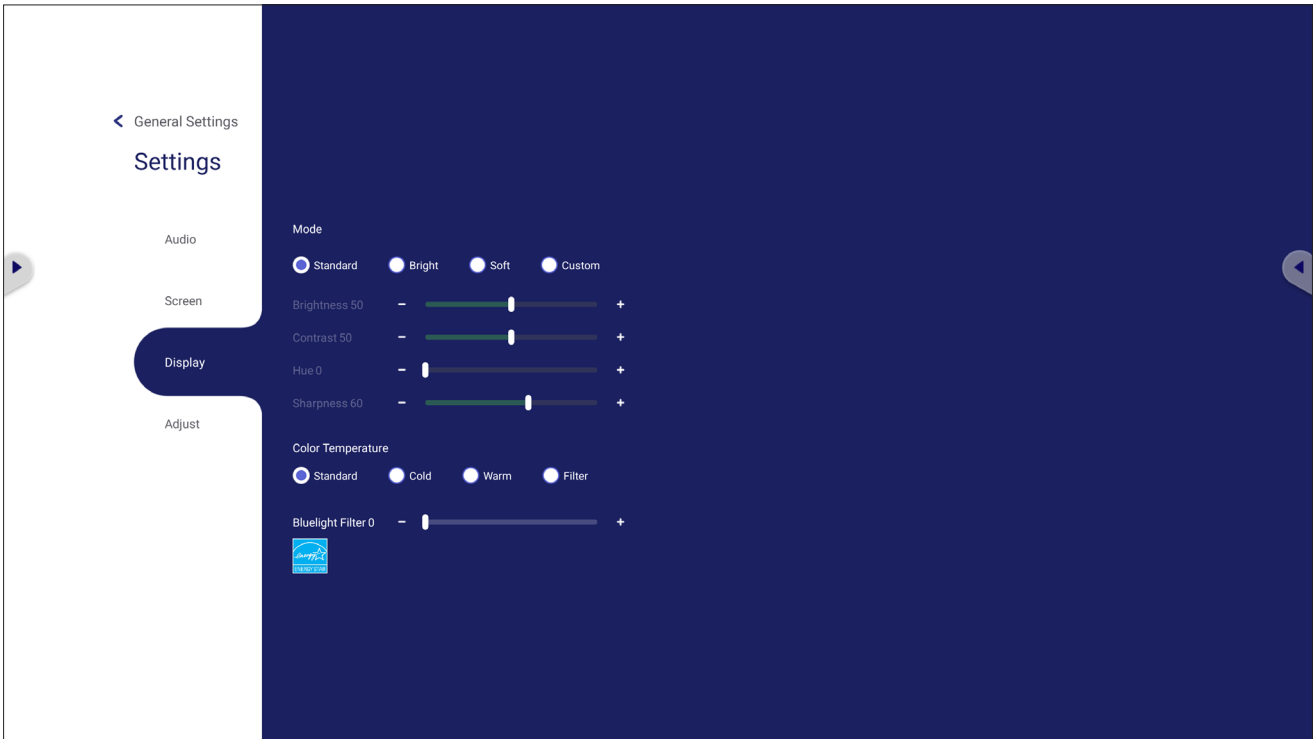

1. Press ▼ on the remote control and select the **Display** menu.
2. Press ▼/▲/◀/▶ on the remote control or directly touch the option to select it.
3. Adjust the Brightness, Contrast, Hue, and Sharpness directly by touching and adjusting each value, or with the remote control by pressing (OK) to adjust the option.
4. Drag the blue light slider directly to adjust the blue light value.



5. Press (Back) on the remote control, or touch a blank area outside of the menu to exit.

Low Blue Light Filter and Eye Health

The Blue Light Filter blocks high-energy blue light for a more comfortable viewing experience.

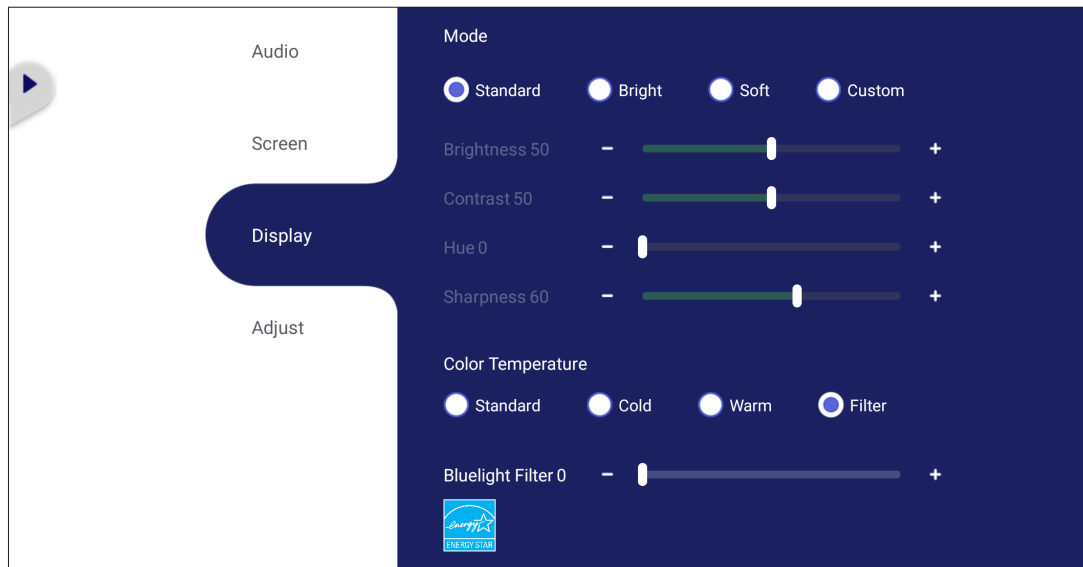

NOTE: To meet TÜV Rheinland low blue light certification, the Display Settings must be:

- Mode: Standard (Brightness and Contrast are 50)
- Color Temperature: Filter
- Blue light Filter: 0

Calculating Breaks

When viewing screens for extended periods, it is recommended to take periodic breaks from viewing. Short breaks of at least 10 minutes are recommended after one (1) hour of continuous viewing.

Taking shorter, more frequent breaks are generally more beneficial than longer, less frequent breaks.

Focus Fatigue (20-20-20 Rule)

To reduce the risk of eye fatigue by constantly looking at the screen, look away from the screen at least every 20 minutes and gaze at a distant object (at least 20 feet away) for at least 20 seconds.

Looking at Distant Objects

While taking breaks, users can further reduce eye strain and dryness by focusing on objects that are further away from them for 10-15 seconds, then gaze at something up close for 10-15 seconds. Repeat this up to 10 times. This exercise reduces the risk of your eyes' focusing ability to "lock up" after prolonged computer work.

Eye and Neck Exercises

Eye Exercises

Eye exercises can help minimize eye strain. Slowly roll your eyes to the left, right, up, and down. Repeat as many times as needed.

Exercises for the eyes

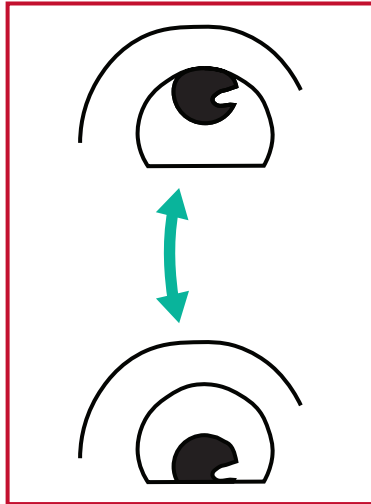

(1) Keep the body and the head upright. Move the eyes up to look at the ceiling, then turn down to look at the floor.

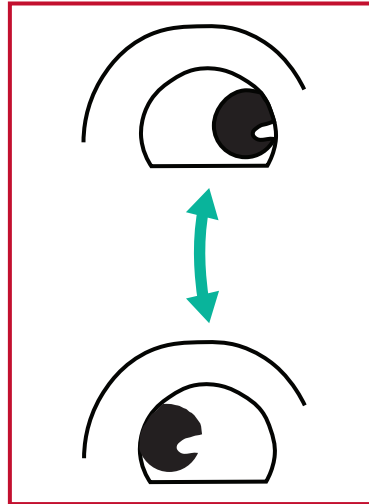

(2) Move the eyes left and right slowly to look at objects on the two sides.

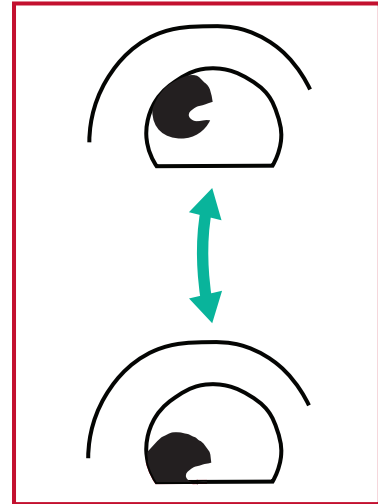

(3) Move the eyes to look at objects at the right upper direction and then right lower direction. Repeat for the left upper and left lower directions.

Neck Exercises

Neck exercises can also help minimize eye strain. Relax your arms and let them hang at your sides, bend forward slightly to stretch the neck, turn your head to the right and to the left. Repeat as many times as needed.

Adjust Settings - (VGA Only)



1. Press ▼ on the remote control and select the **Adjust** menu.
2. Press ▼/▲/◀/▶ on the remote control or directly touch the option to select it.
3. Adjust your preference by touching each value directly, or with the remote control by pressing (OK).
4. Press (Back) on the remote control, or touch a blank area outside of the menu to exit.

Settings - ViewBoard Player

When the ViewBoard is in the ViewBoard Player input source, press  on the remote control or tap the setting icon next to the input source in the On-Screen Display (OSD) Menu's Input Settings to enter the **Settings** menu.

Wireless & Network

Check current network connection status, set up and manage Wi-Fi, Ethernet, Bluetooth, and VPN, and establish a Wireless hotspot.

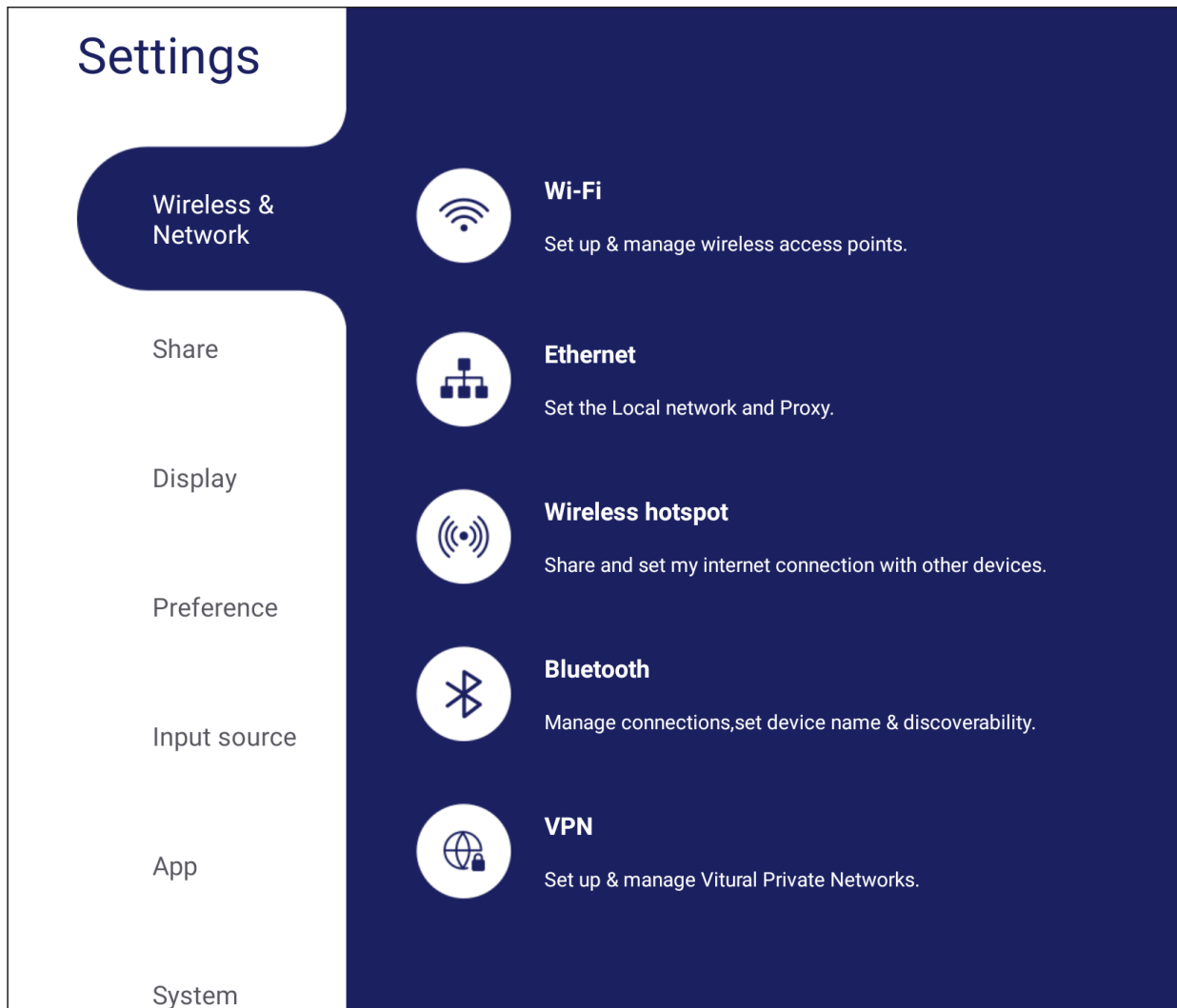

NOTE:

- Wi-Fi, Wireless hotspot and Bluetooth settings will appear when LB-WIFI-001(optional) has been installed.
- Ethernet will disable automatically when Wi-Fi is enabled. Wi-Fi will disable automatically when Ethernet is enabled.
- Miracast will disable when Wireless hotspot is enabled. Wireless hotspot will disable when Miracast hotspot is enabled.

Wi-Fi

Setup and manage wireless access points.

- Tap the toggle button to turn Wi-Fi **On** or **Off**.

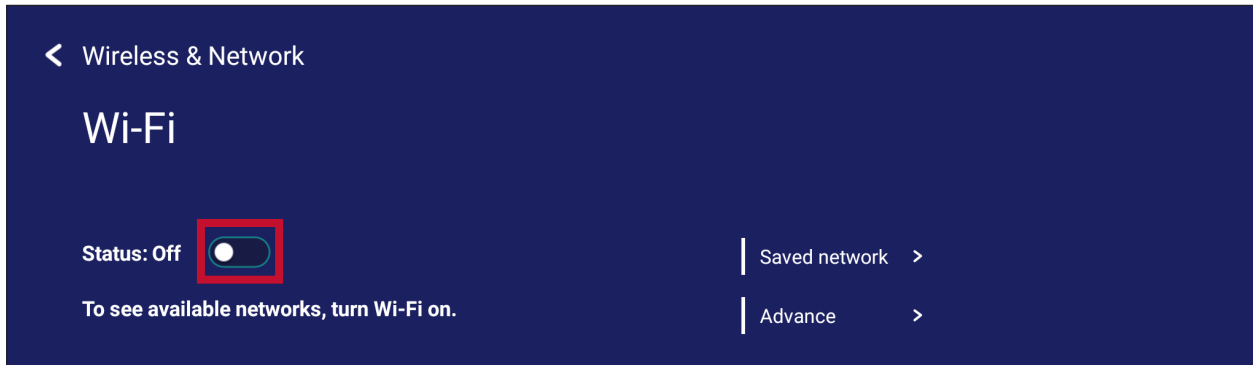

- Once **On**, you can: **Add a Network**, view **Saved Networks**, **Refresh** the network list, or view **Advanced** settings.

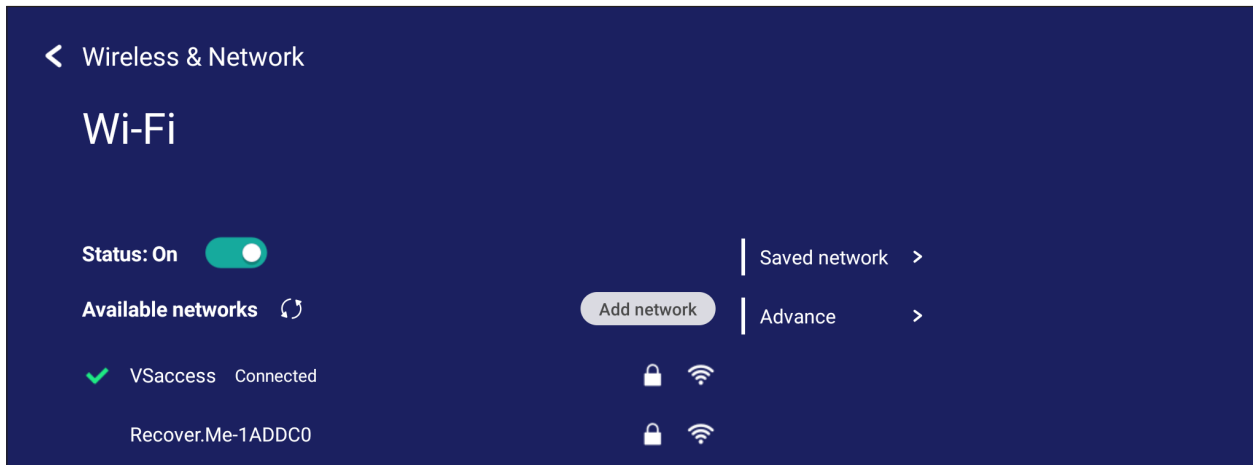

- In **Advanced** settings, you can toggle **Network notifications On** or **Off** and view **Network card info**.

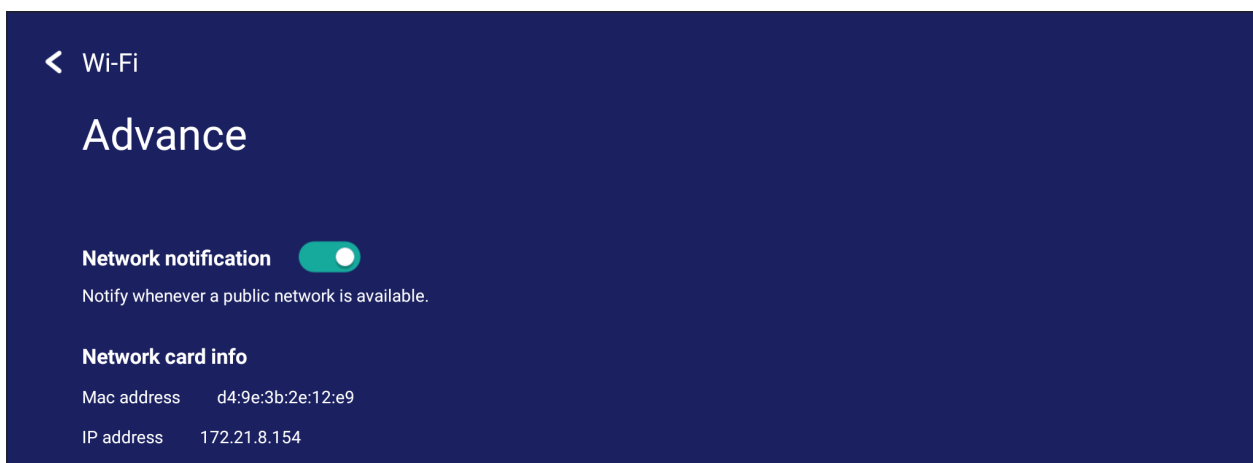

Ethernet

Set the local network and proxy.

- Tap the drop down menu to connect/disconnect the Ethernet.

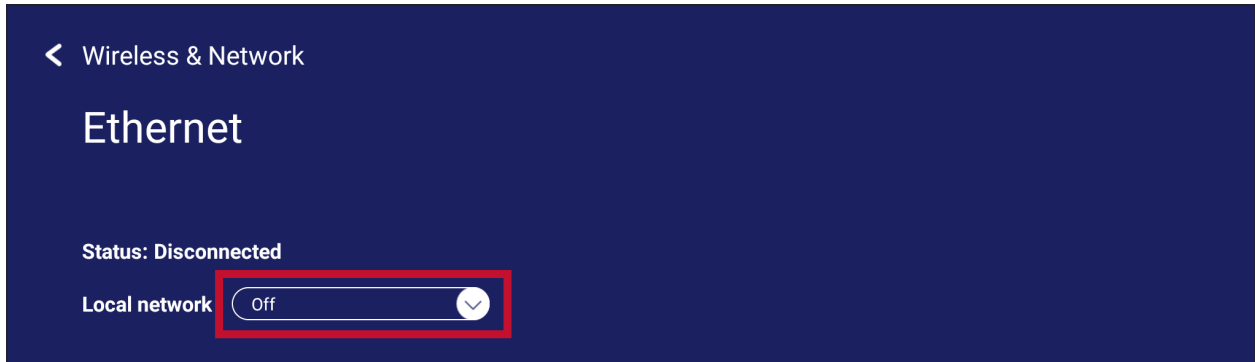

- You can adjust **Local network** and **Proxy** settings as well.

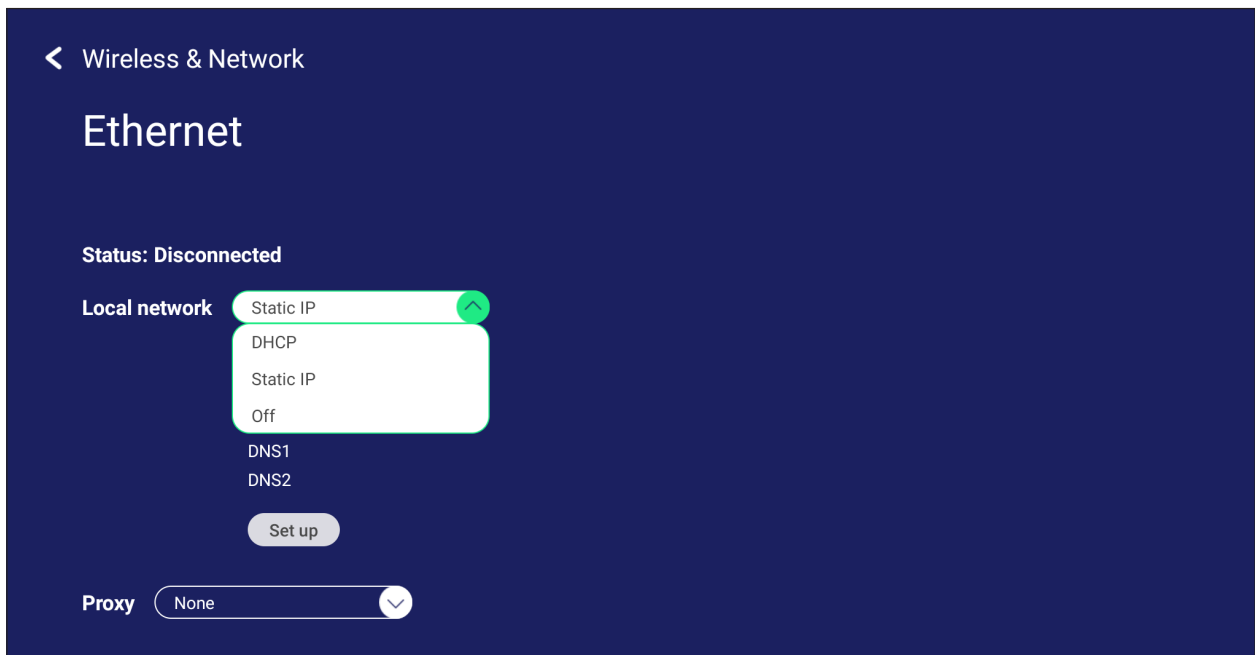

Wireless Hotspot

Set and share my internet connection with other devices.

- Tap the toggle button to turn **Wireless hotspot On** or **Off**.

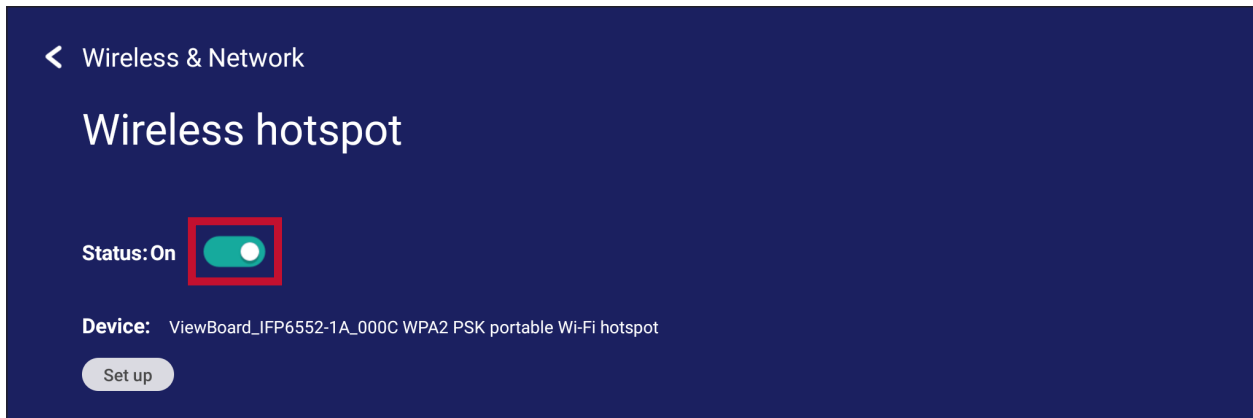

- Tap **Set up** to set the **Network name**, **Security**, and **Password**.

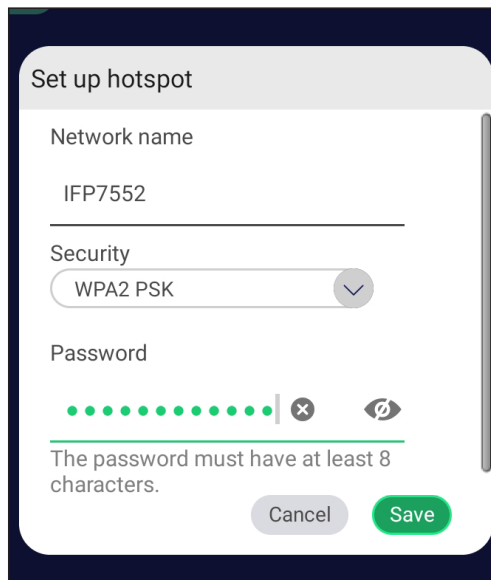

VPN

Setup and manage Virtual Private Networks.

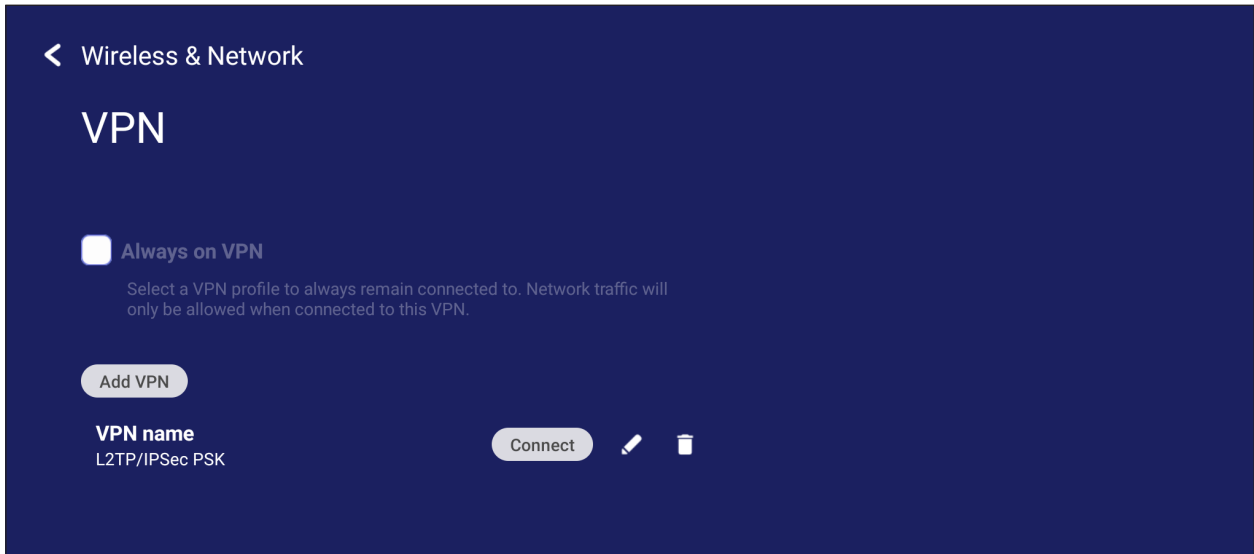

To create a VPN profile:

1. Go to: **Settings > Wireless & Network > VPN** and tap **Add VPN**.

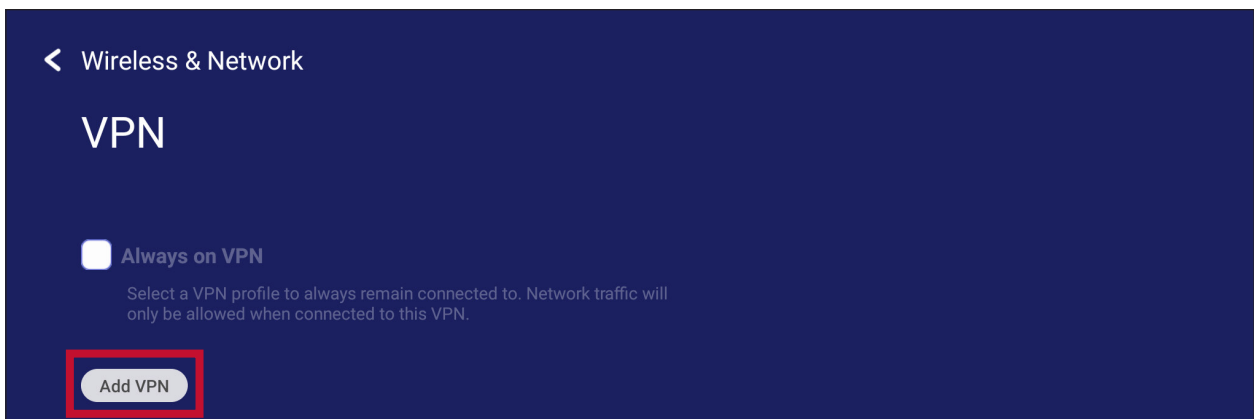

2. Key in the **Name**.

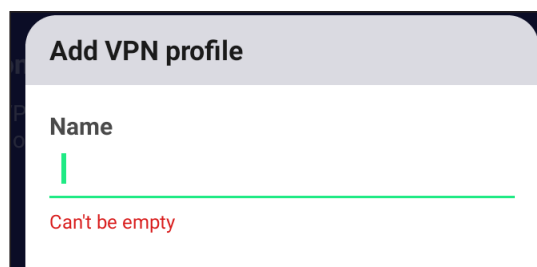

3. Select the VPN Type.

Add VPN profile

Name

Can't be empty

Type

PPTP

PPTP

L2TP/IPSec PSK

L2TP/IPSec RSA

IPSec Xauth PSK

IPSec Xauth RSA

IPSec Hybrid RSA

Advanced options

4. Choose to enable/disable **PPP encryption (MPPE)** and/or show **Advanced options**.

Server address

Can't be empty

PPP encryption(MPPE)

Advanced options

Username

Password

Always-on VPN

This VPN type can't stay connected at all times

Cancel Save

Share

SAMBA

The SAMBA Service provides file sharing via LAN. When the SAMBA Service is enabled, the user can explore the ViewBoard file system with a PC or mobile equipment.

1. To access, go to: **Settings > Share > SAMBA.**

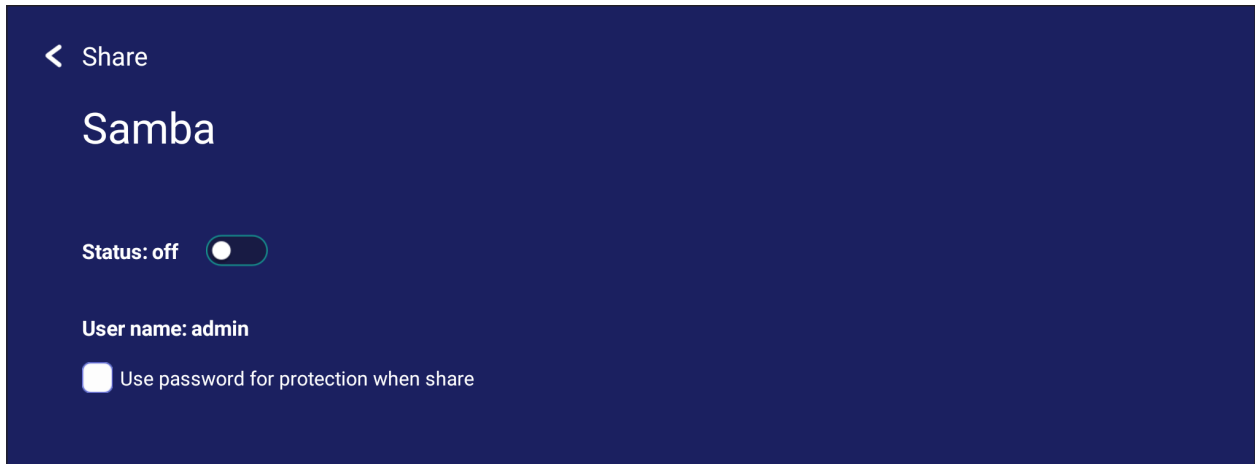

2. Tap the toggle button to enable the SAMBA Service, then set a password if needed.

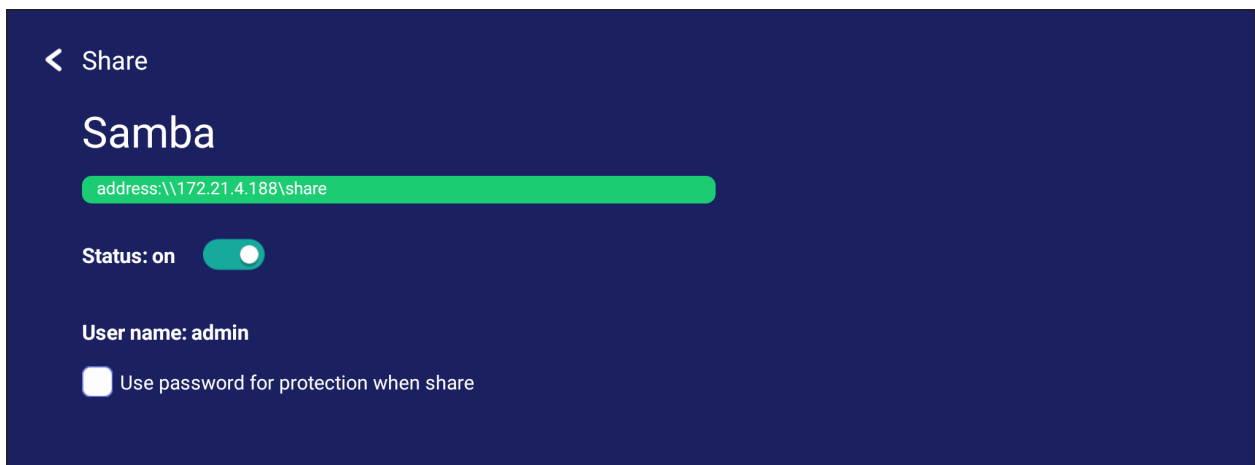

3. Ensure the ViewBoard and client equipment are connected to the same network.
4. Log in to the ViewBoard with the client equipment. Input the ViewBoard's IP address.



5. Key in the user name and password, then select **OK** (if necessary).

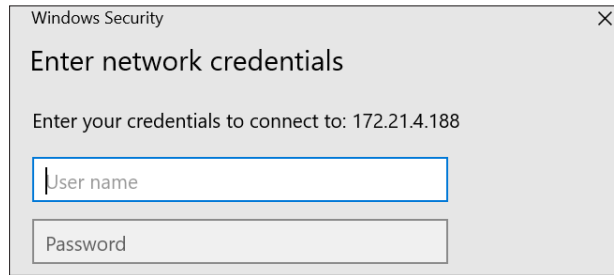

6. After a successful log in, the ViewBoard files will be available.

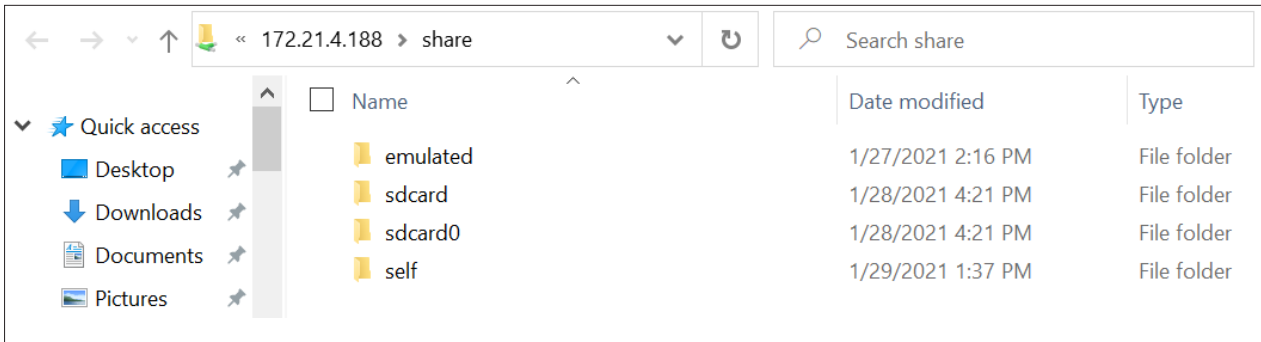

Display

Adjust the Wallpaper, Theme, Protection, and HDMI Out settings.

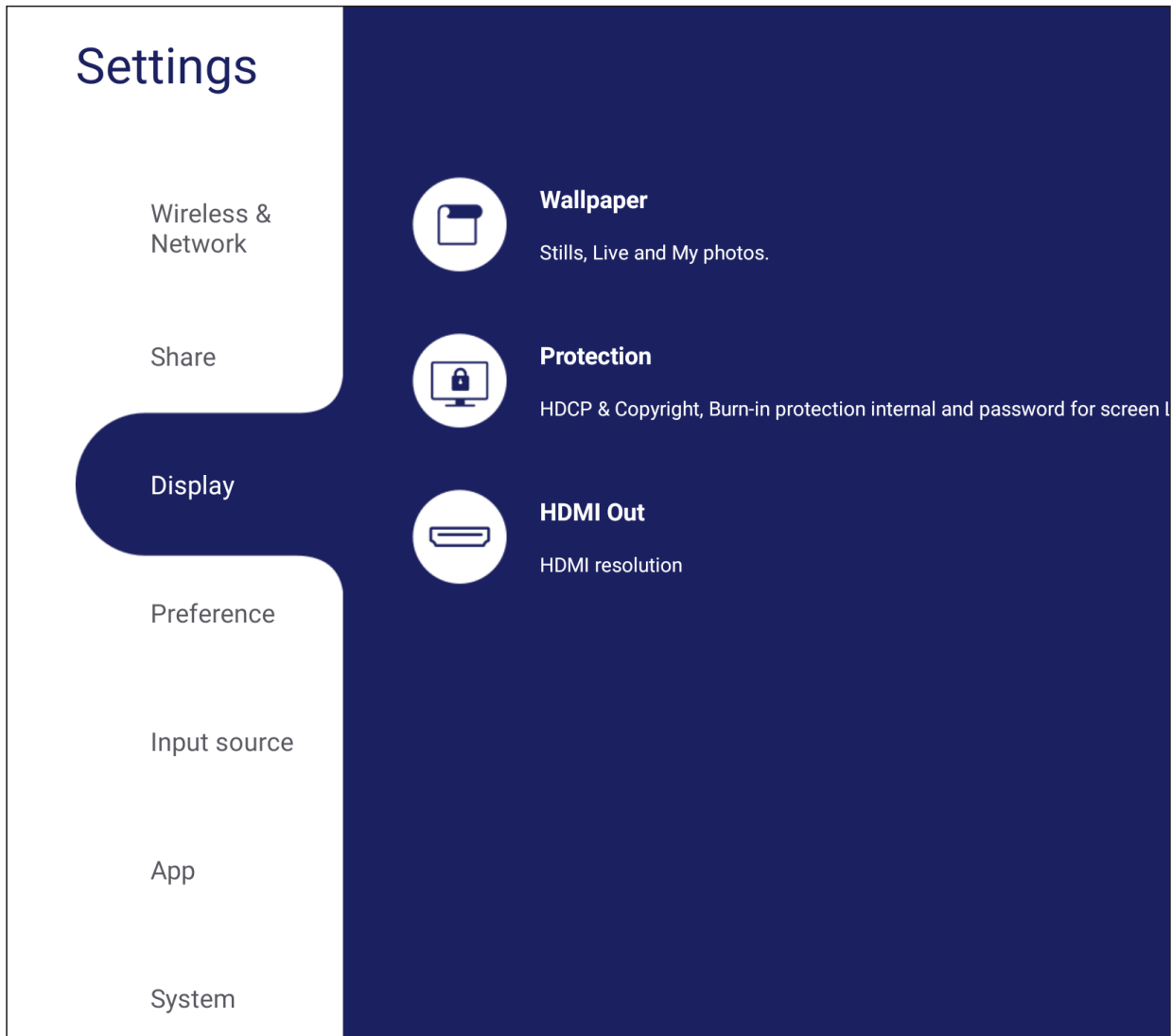

NOTE: The HDMI Out feature is only available on select models.

Wallpaper

Users can change their wallpaper with default images (both still and live), or use their own by tapping **My Photo** and selecting the image file.

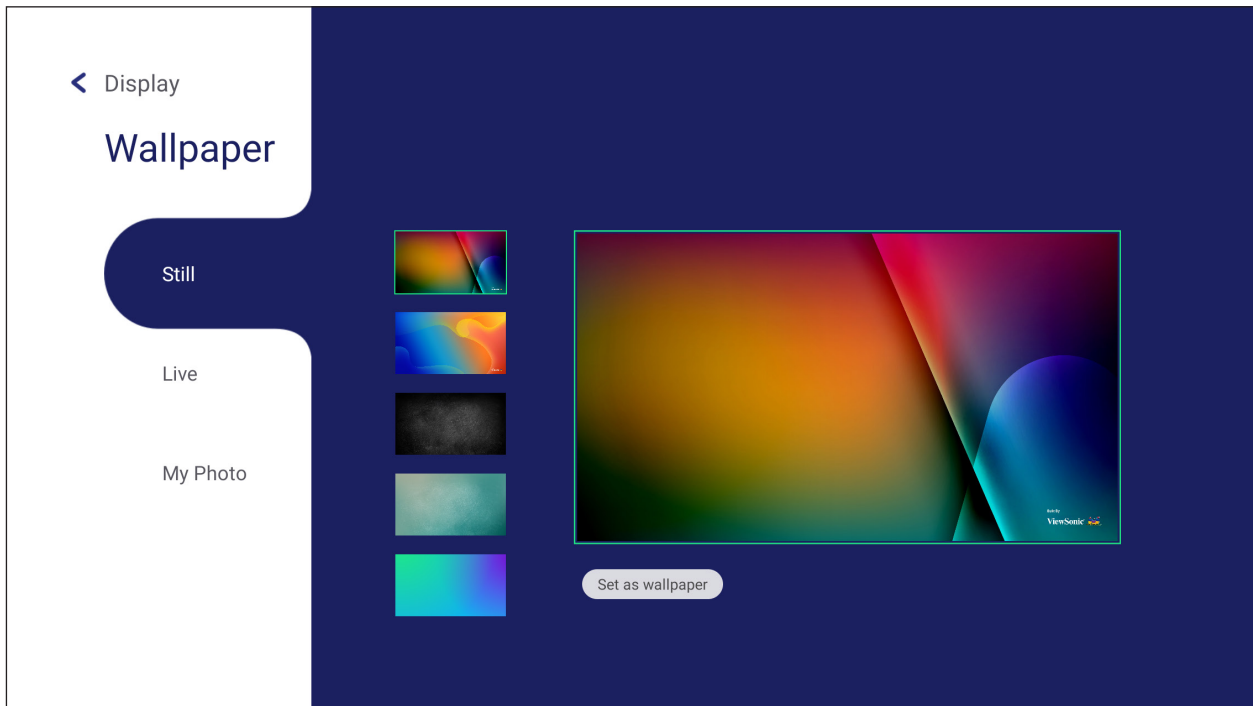

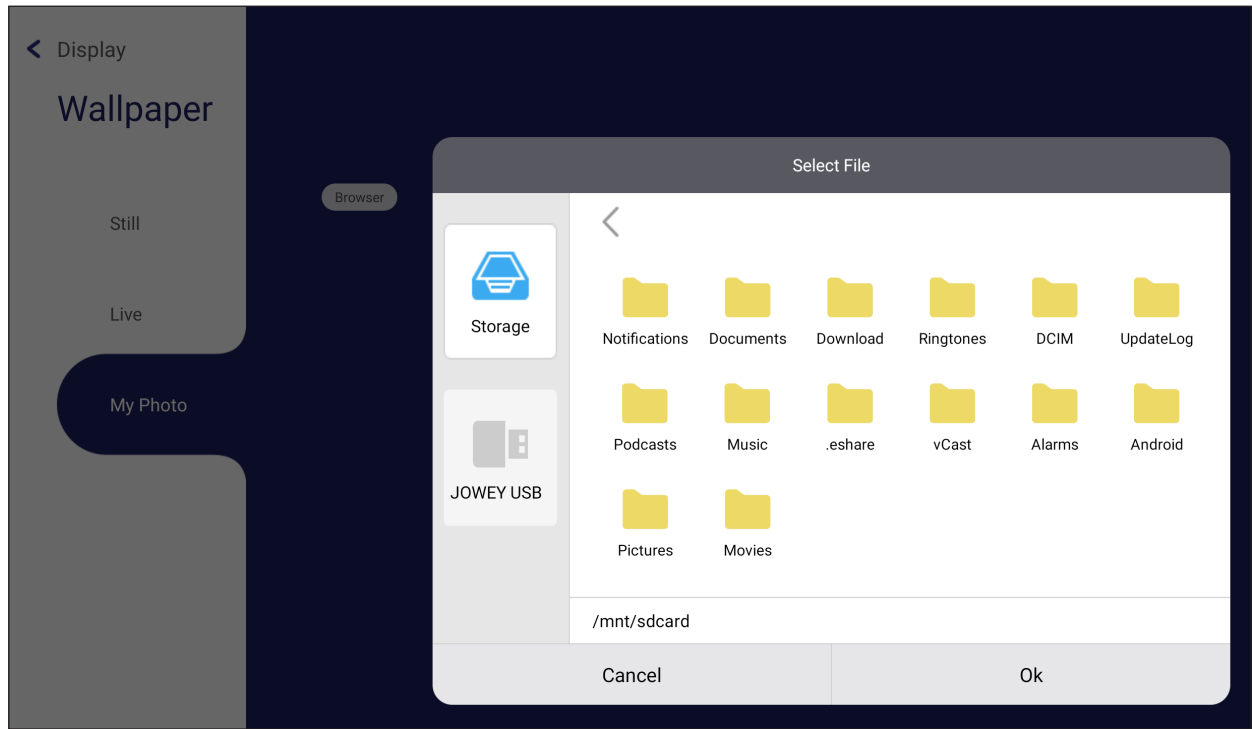

Protection

Toggle **HDCP & Copyright** and set a **Password for Screen Lock**.

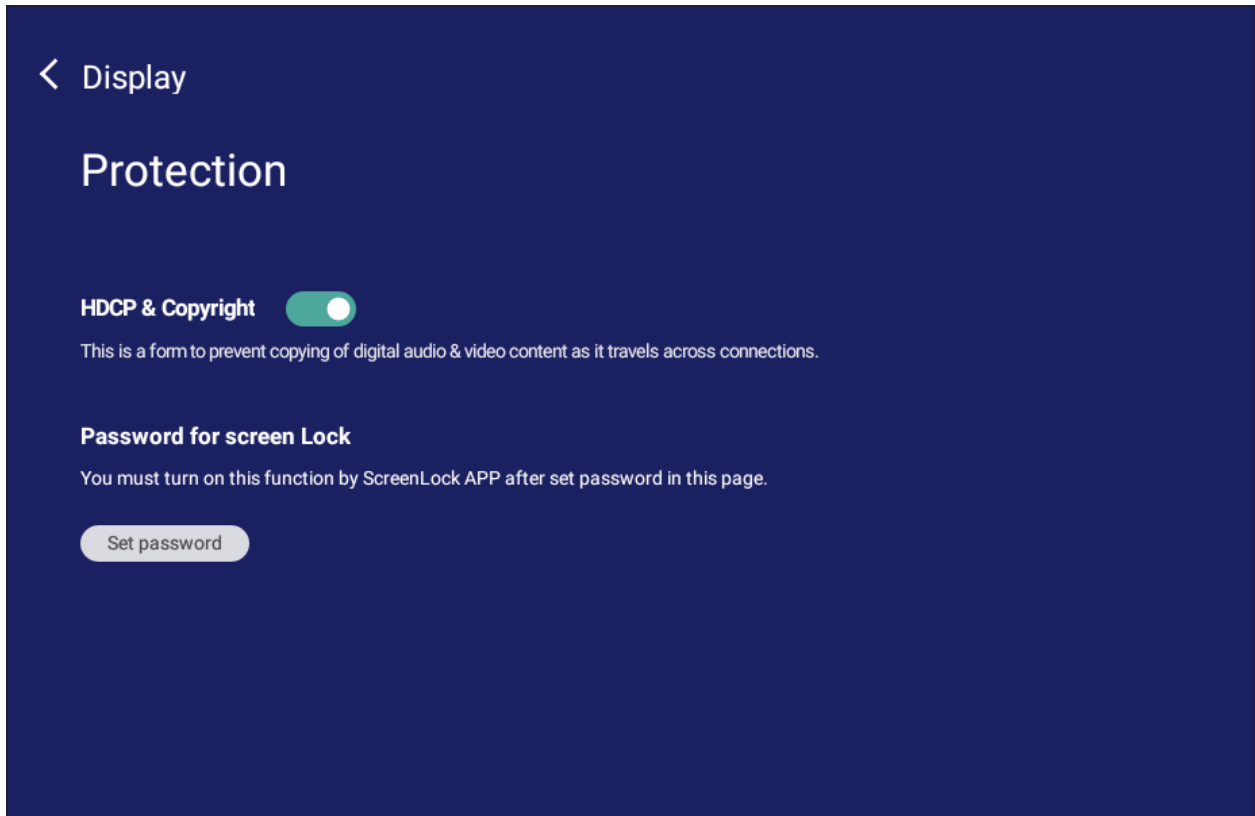

- To set up a password for screen lock, tap **Set Password** and enter the desired password.

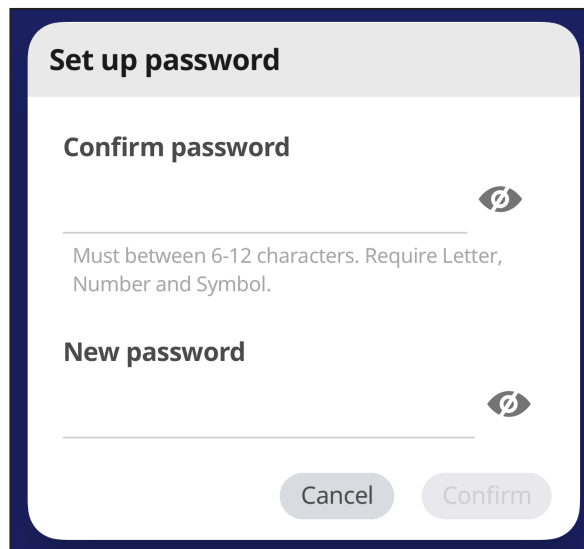

HDMI Out

Adjust the HDMI Out Resolution setting.



NOTE: The HDMI Out feature is only available on select models.

Preference

View and adjust **Touch, Language, Keyboard & Input, Date & Time, Boot Mode, Start up & Shut down, and Toolbar** settings.

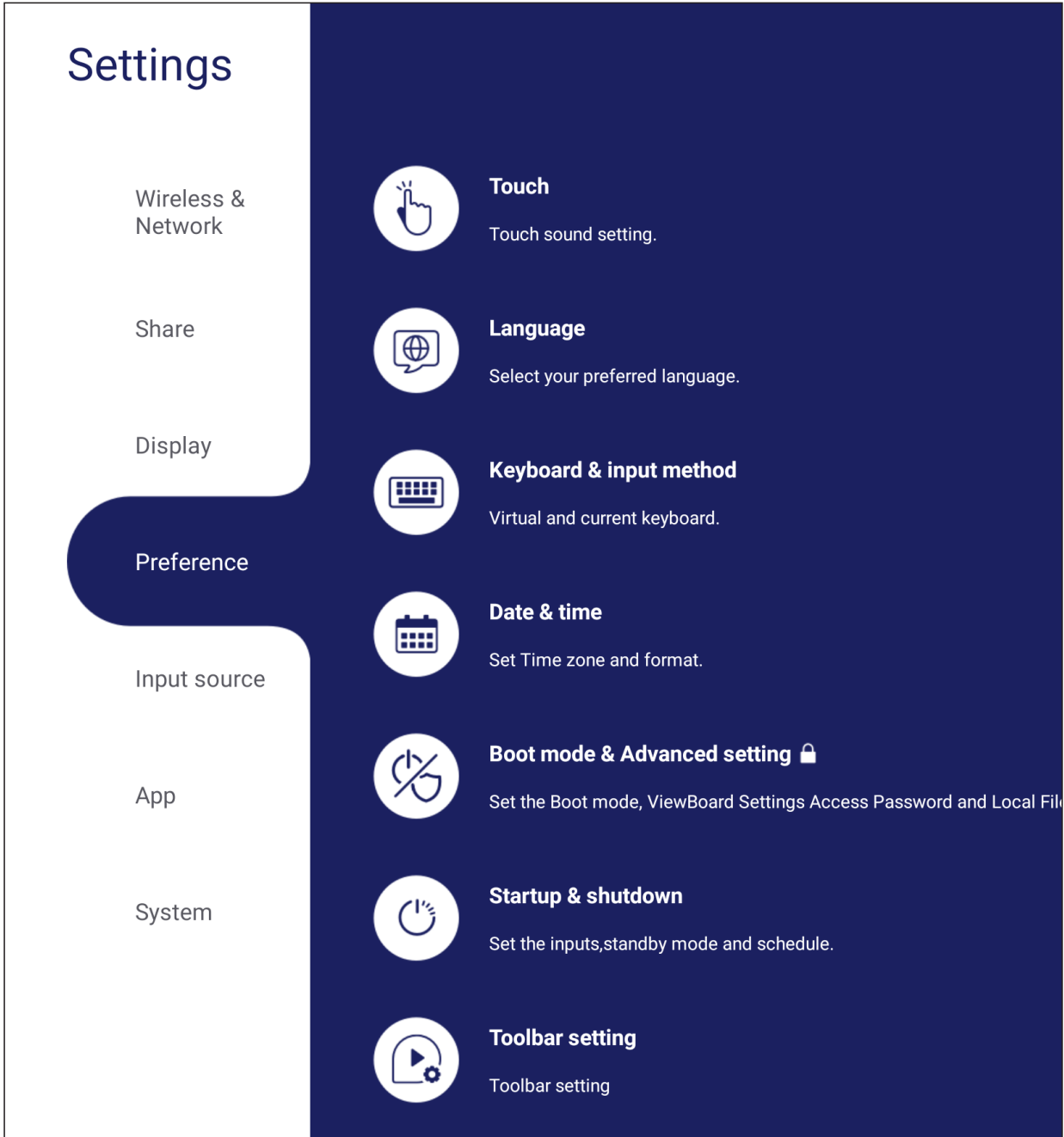

Touch

Adjust **Touch Settings** and toggle **Touch Sounds On/Off**.



Language

Adjust and choose the preferred language from the available languages.

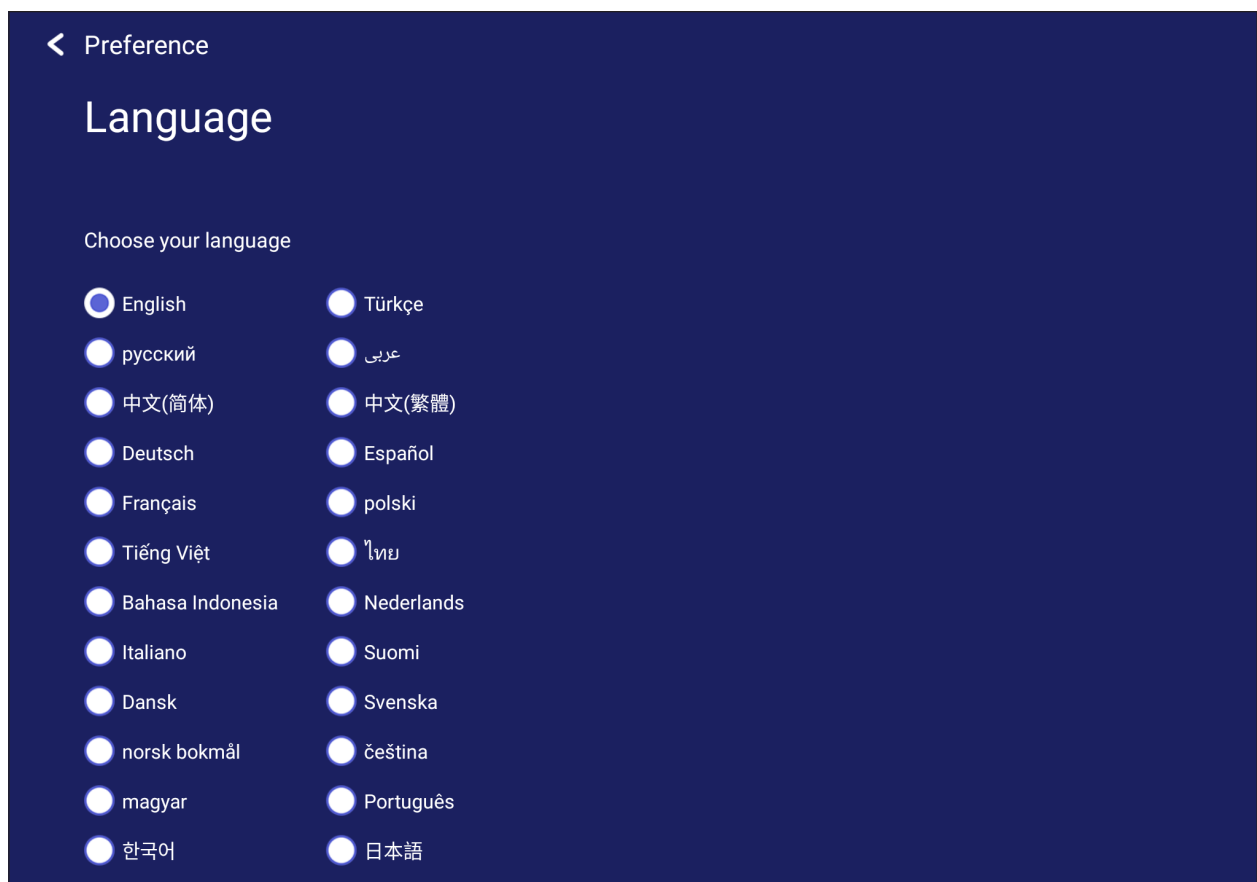

Keyboard & Input Method

Enable/disable the visual keyboard and/or change the default input method.

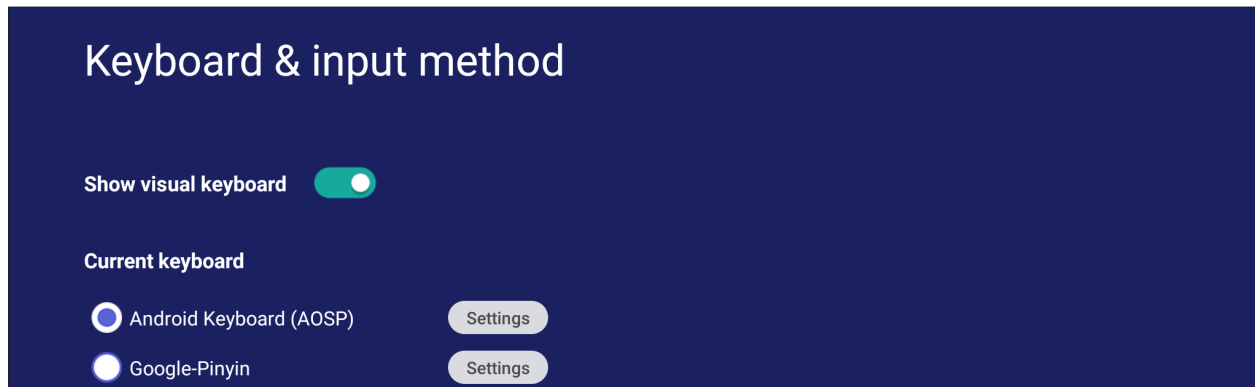

- Tap on **Settings** to adjust the advanced keyboard settings.

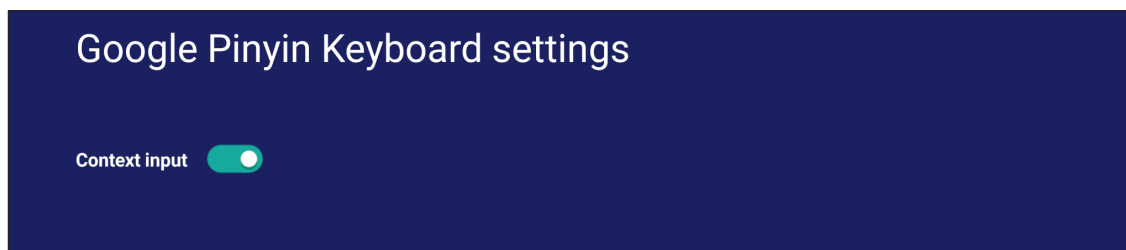

Date & Time

Set the system time and format.

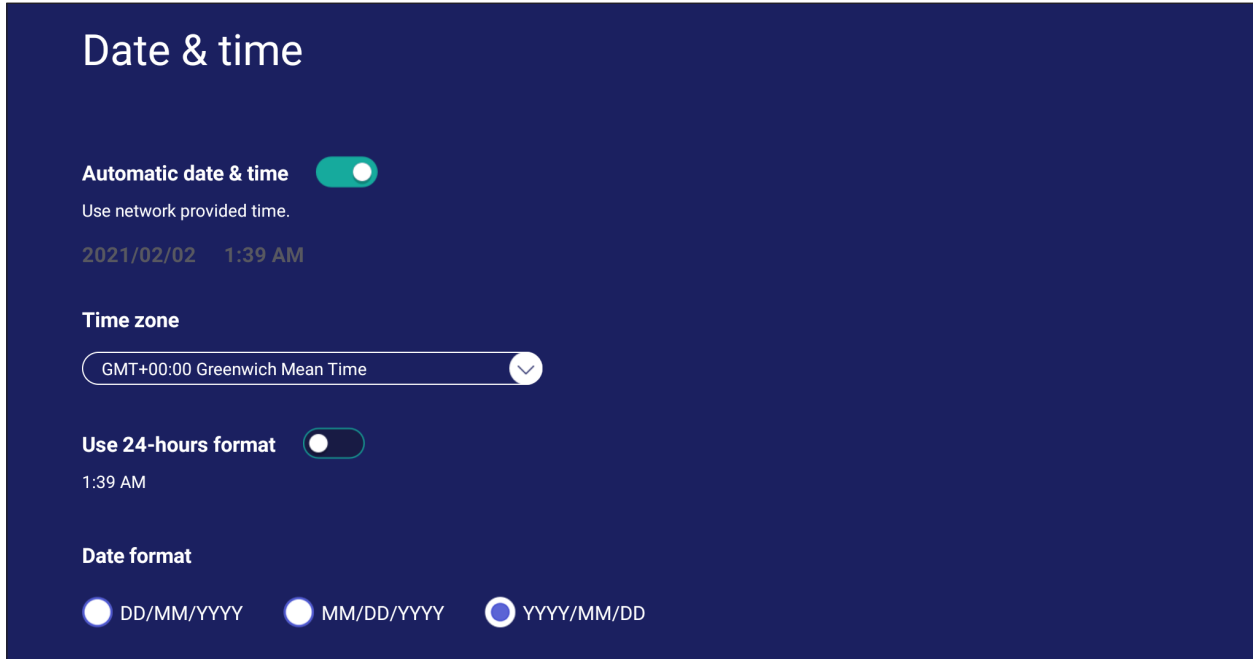

| Item | Description |
|----------------------------------|--|
| Automatic Date & Time | When enabled, the ViewBoard will automatically synchronize the date and time via the Internet. |
| Time Zone | Select the appropriate time zone. |
| Time Format | Choose from 12-hour or 24-hour time format. Simply toggle 24-hour format On/Off. |
| Date Format | Select from the available date formats. |

Boot Mode

Adjust the preferred boot up mode and set/reset a password.

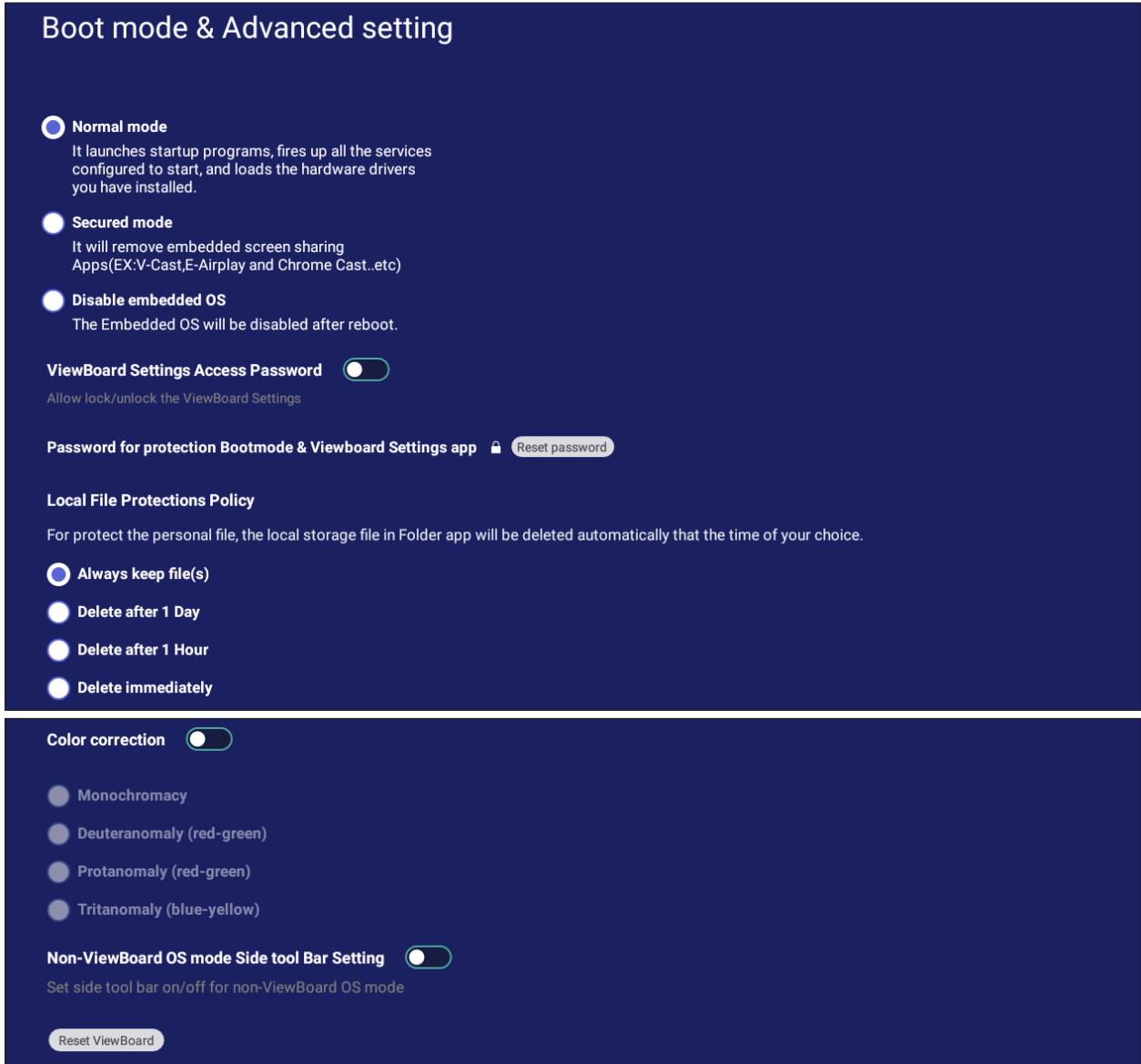

| Item | Description |
|---|---|
| Normal Mode | The embedded screen sharing Apps will run normally. |
| Secured Mode | The embedded screen sharing Apps will be removed. |
| Disable Embedded OS | The system will automatically reboot, and then the Embedded OS will not appear. |
| ViewBoard Settings Access Password | Toggle to lock/unlock the ViewBoard Settings. |
| Password for Protection | Modify the Boot mode and ViewBoard Settings entry password. |
| Local File Protection Policy | Choose how long to keep local storage files in the Folder app. |
| Color Correction | Color correct the ViewBoard display screen. |
| Non-ViewBoard OS Mode Side Toolbar Setting | Enable the side toolbar for non-ViewBoard OS. |
| Reset ViewBoard | Reset the ViewBoard to its factory default settings. |

Startup & Shutdown

Set the **Startup Input**, **Standby Mode**, **EnergyStar Mode**, **Black Screen After Startup**, **Power off Reminder** timer and **Schedule** settings.

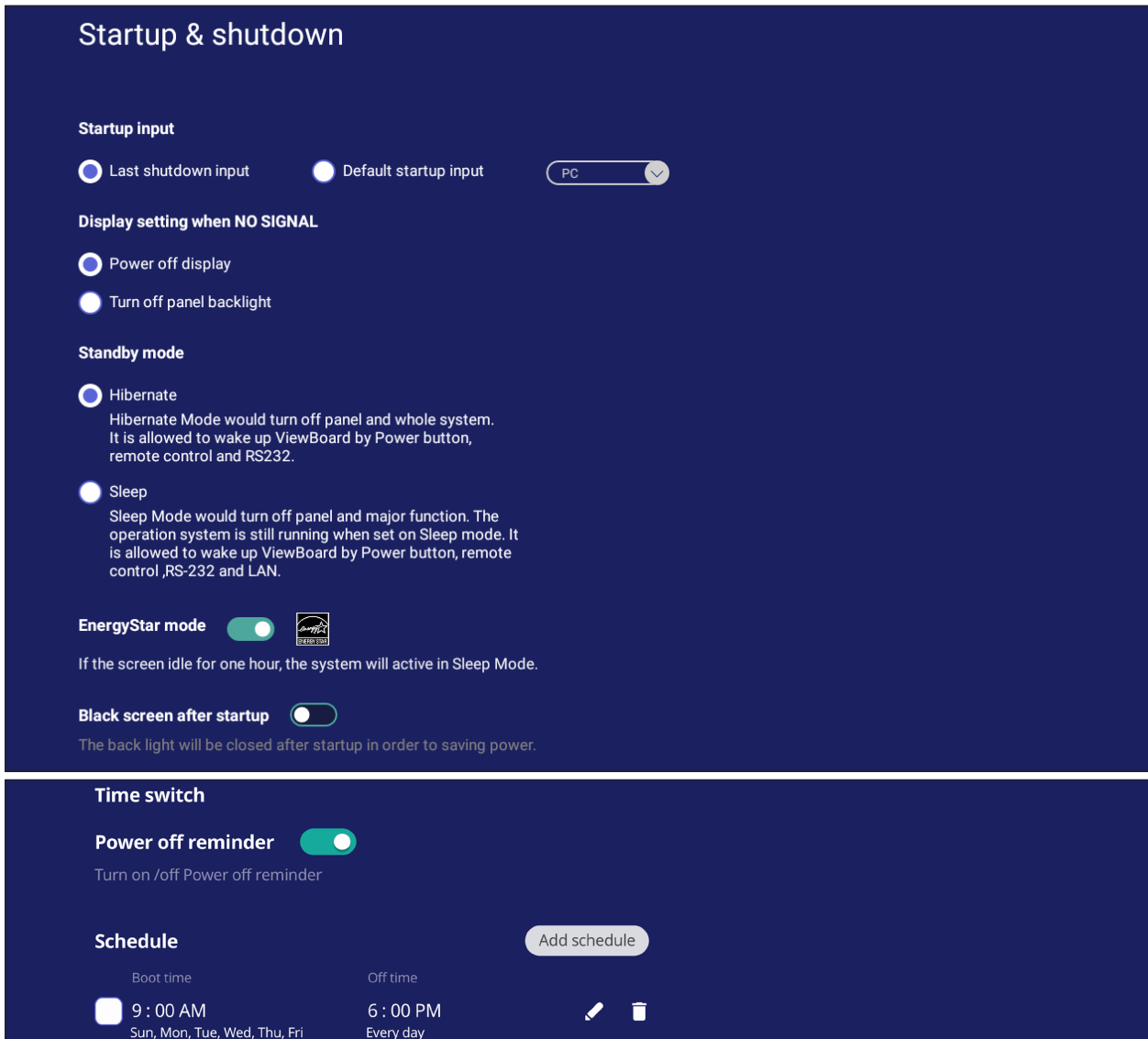

| Item | Description |
|---------------------------------------|---|
| Startup Input | Adjust the Startup Input preference. |
| Display Setting when No Signal | Decide what happens to the display when there is no signal for HDMI, PC, or VGA sources. |
| Standby Mode | Decide what happens when you press the Power button while the ViewBoard is <i>On</i> . |
| EnergyStar Mode | Enable to automatically initiate <i>Sleep Mode</i> when the screen is idle for one hour. |
| Black Screen After Startup | When enabled, the ViewBoard will turn off the backlight automatically after booting up. |
| Time Switch Power Off Reminder | When enabled, the ViewBoard will turn off without any reminder after the scheduled off time. |
| Schedule | Schedule a Boot and Shut off time. |

Toolbar Setting

Adjust the Side toolbar settings.



Input Source

Adjust the input source names and settings, as well as the side tool bar settings.

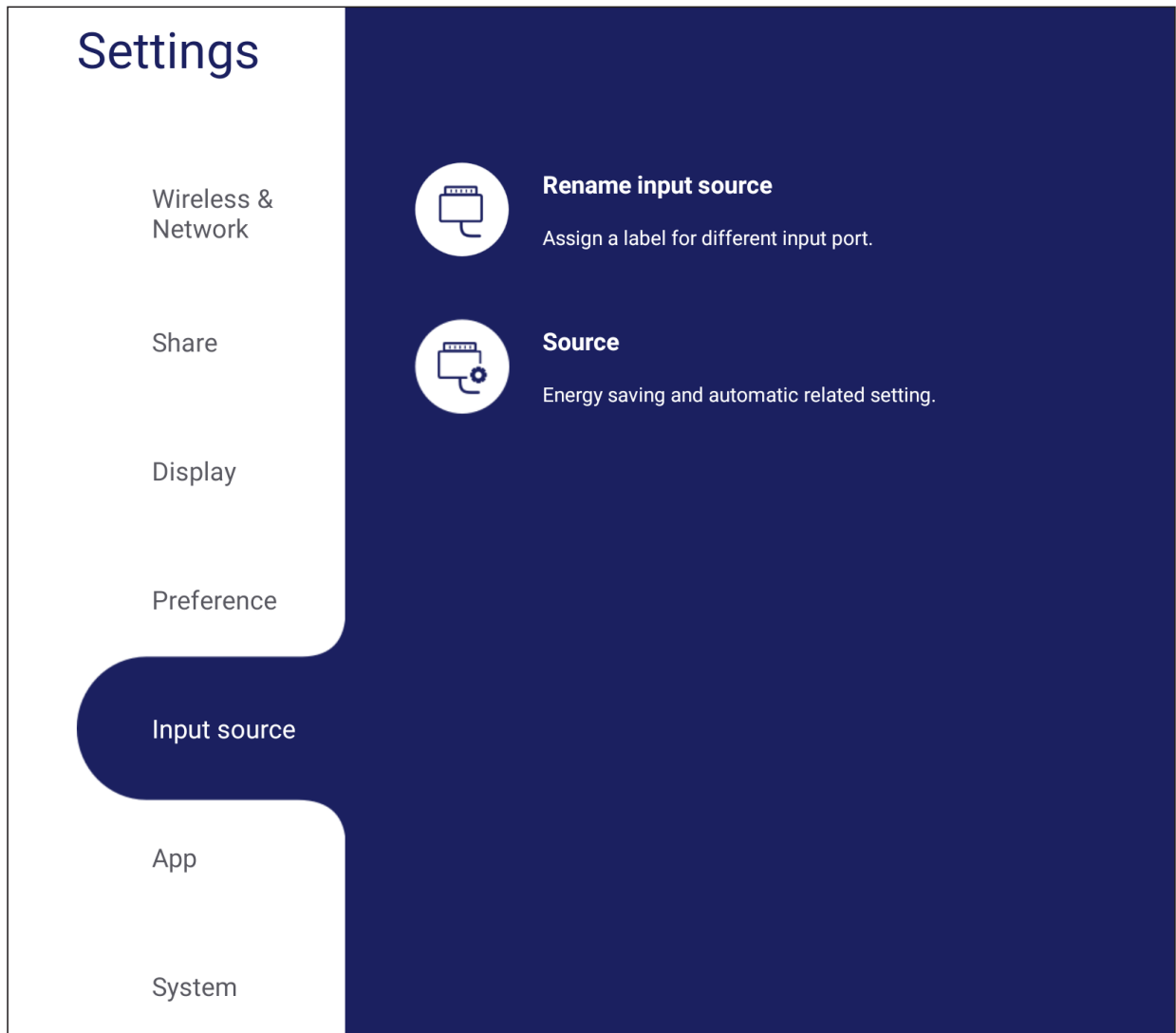

Rename Input Source

Set labels for each input source that will be easily recognized when displayed.

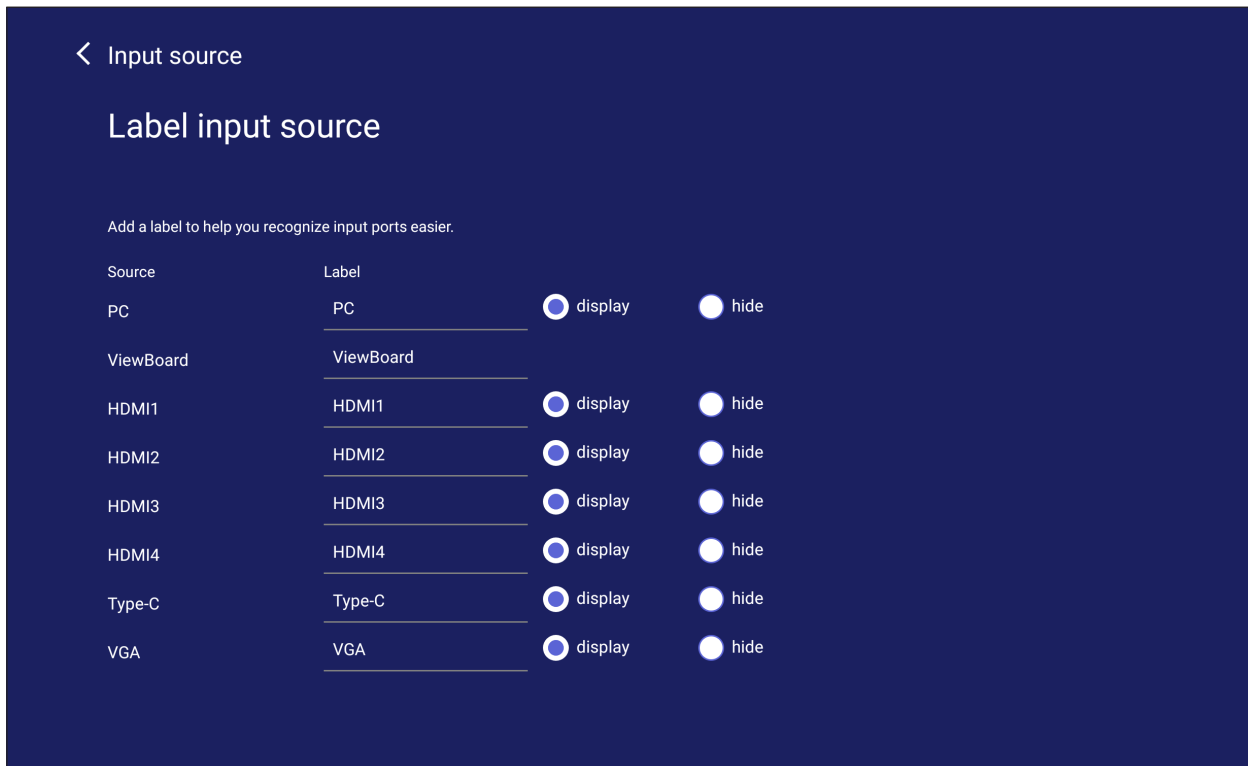

Source

Toggle Wake up by active source, Signal auto search, and HDMI CEC and select Input port auto switch.

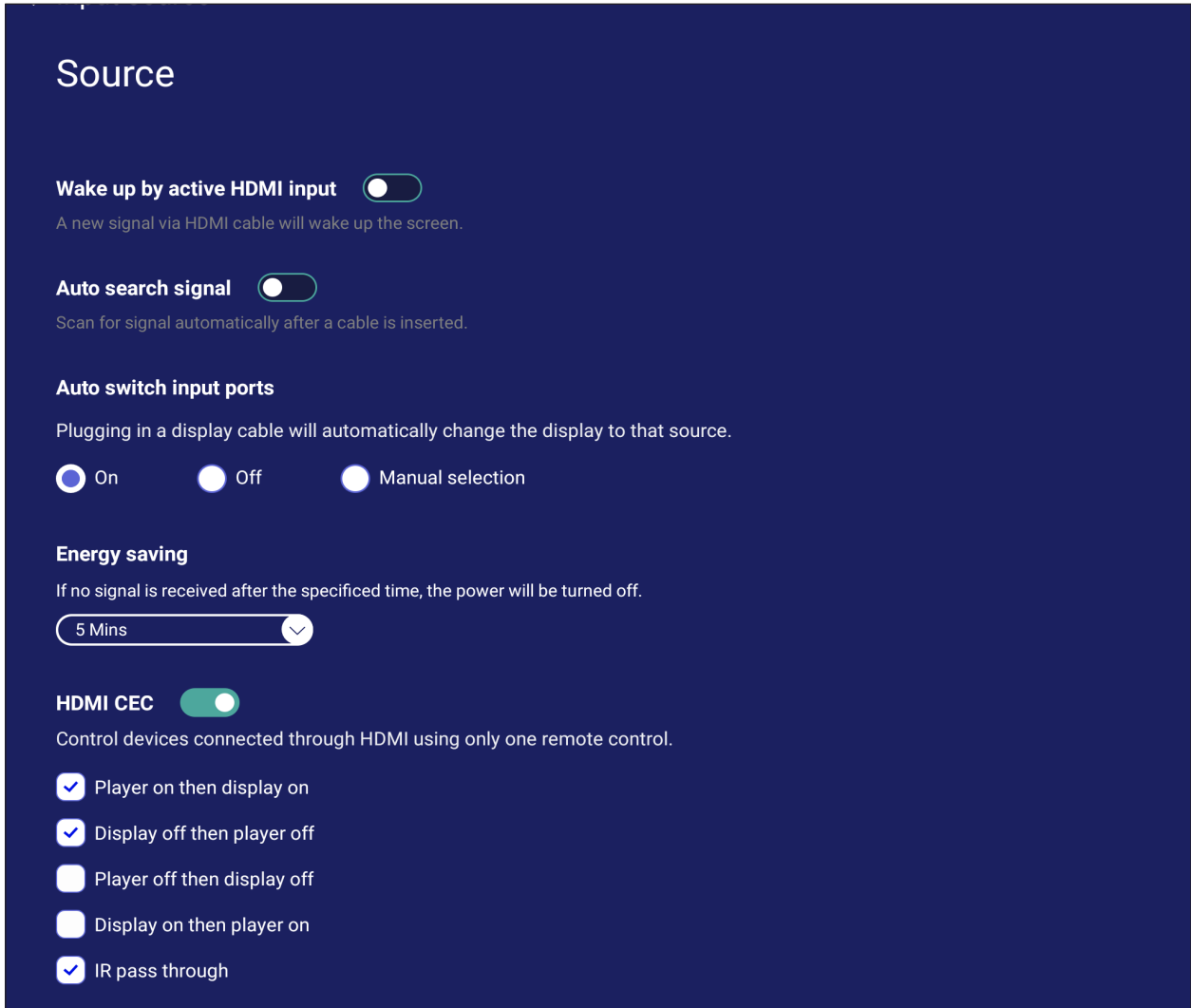

| Item | Description |
|-------------------------------------|--|
| Wake up by Active HDMI Input | The screen will turn on automatically after plugging in an HDMI cable when the screen is off. |
| Auto Search Signal | When enabled, if the current source does not have a signal, the ViewBoard will automatically search for an input source. |
| Auto Switch Input Ports | The original signal will automatically switch to a new cable after it's plugged in. |
| Energy Saving | Set a time period to power off if no signal is detected. |
| HDMI CEC | Enable/disable HDMI CEC functions. |

App

The user can view App information and force stop, uninstall, clear data, clear cache, and clear defaults.

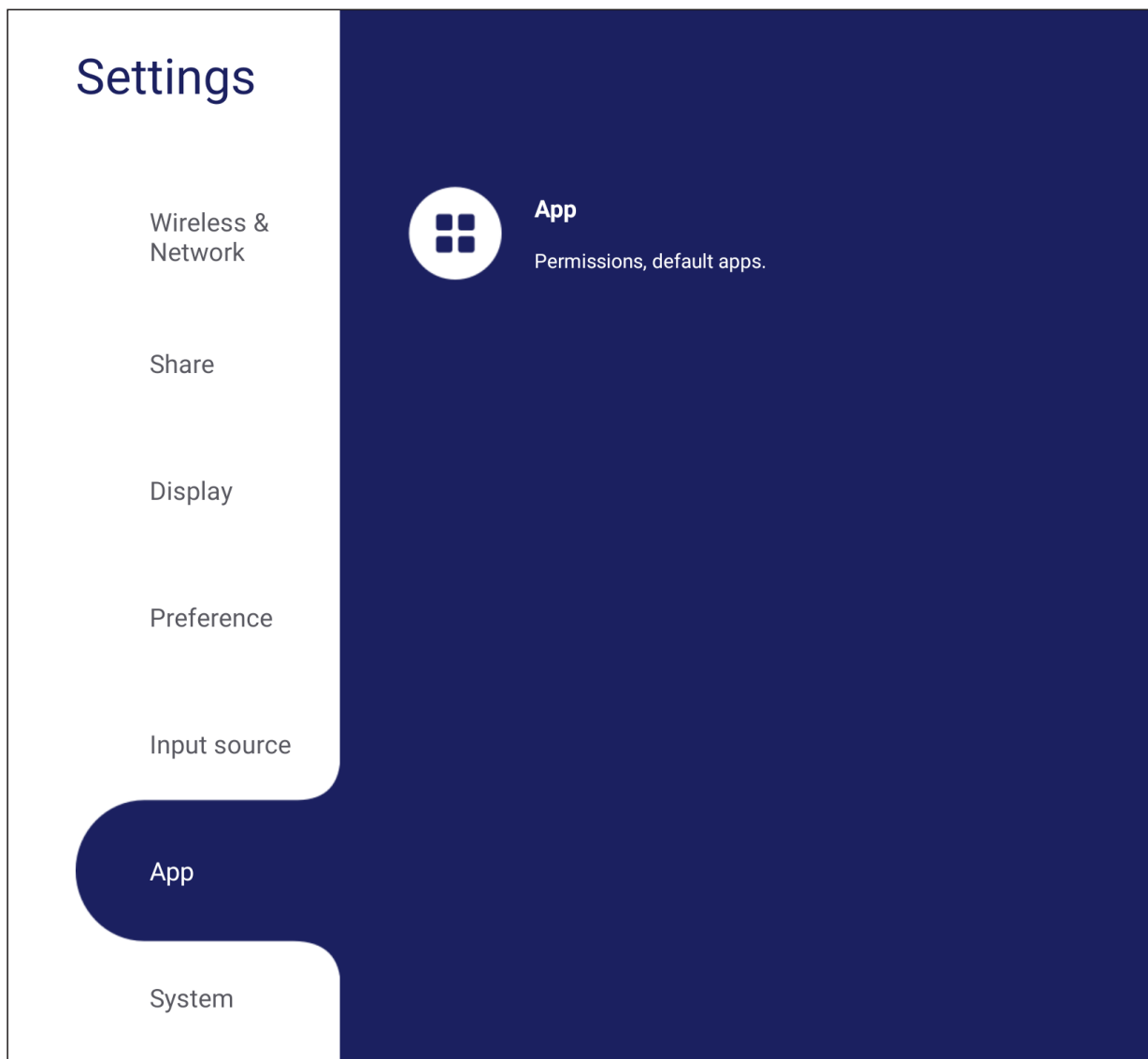

NOTE:

- Pre-loaded apps cannot be uninstalled.
- Not all apps support Clear Defaults.

APP

View any running or installed applications. Tap on them for more detailed information and options.

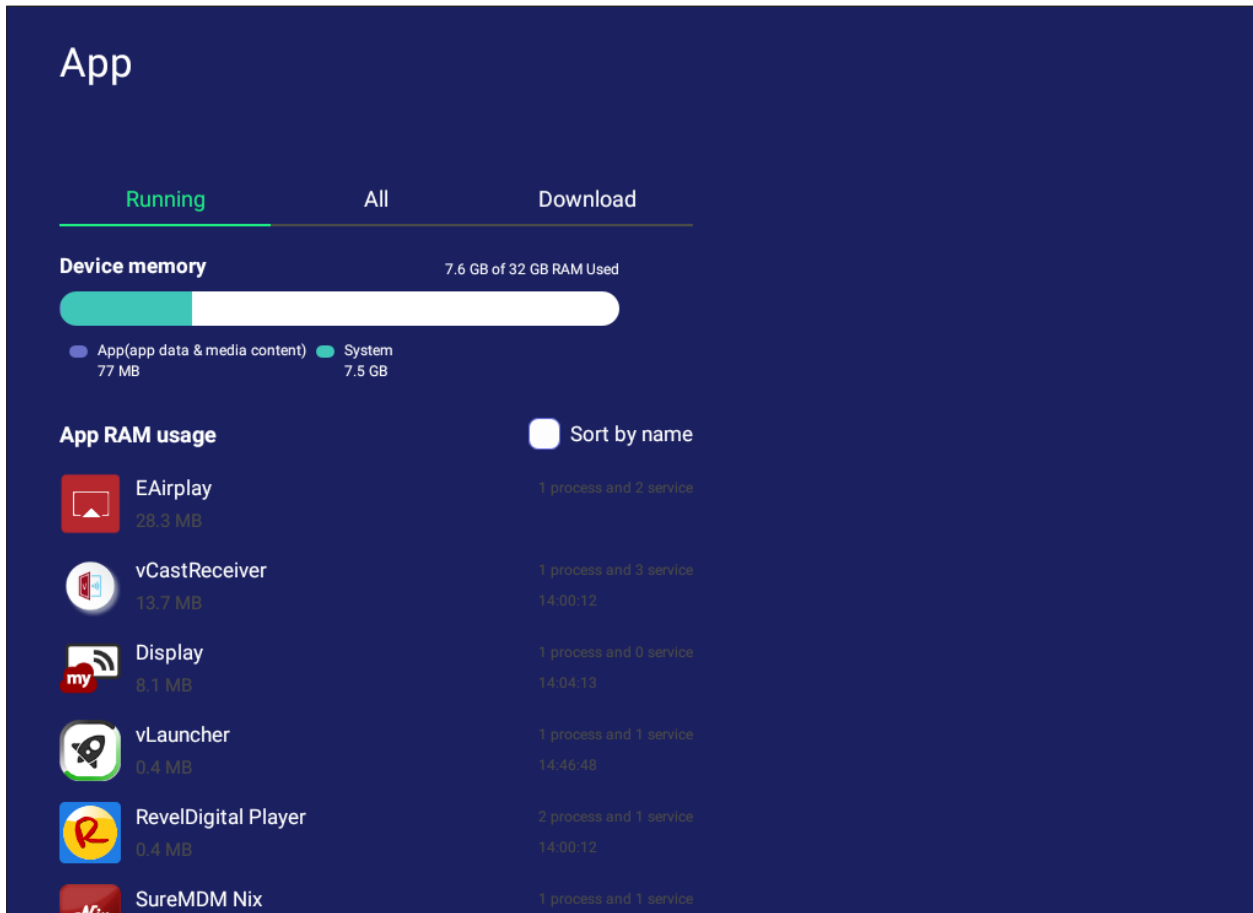

- By tapping on a running application, you can see more information, stop, or report the application.

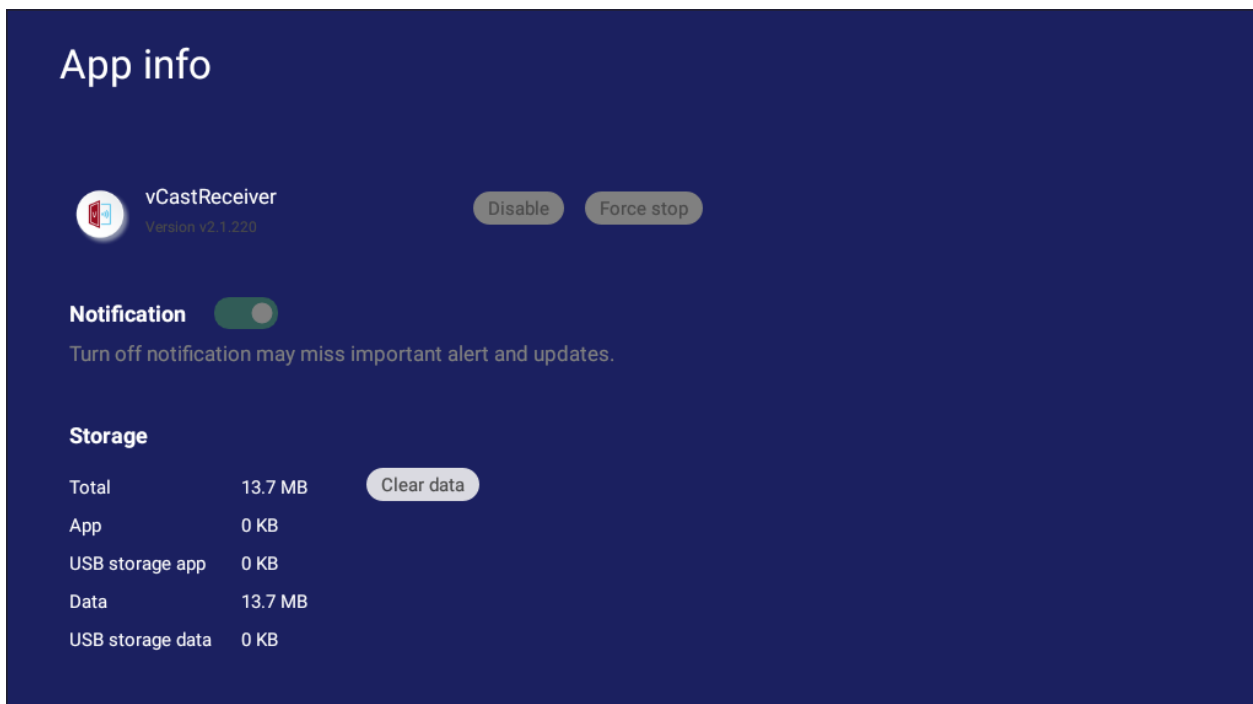

- Selecting **All**, **Download**, or **USB storage** will list all installed applications.

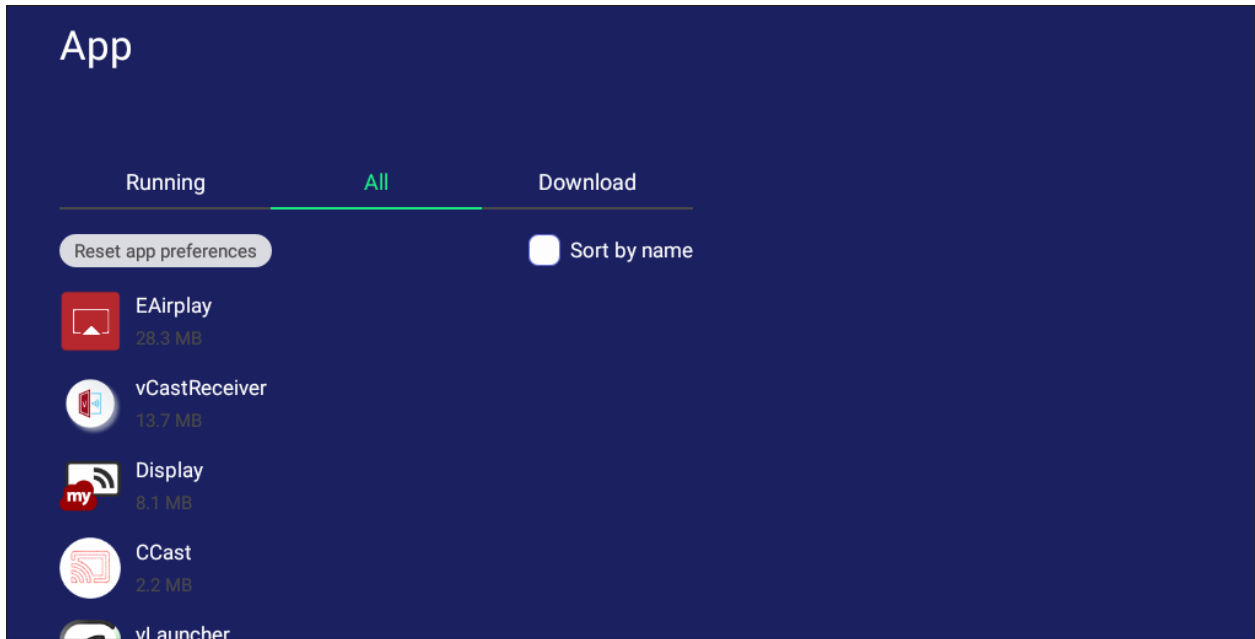

- Tapping on any application will display further information and options.

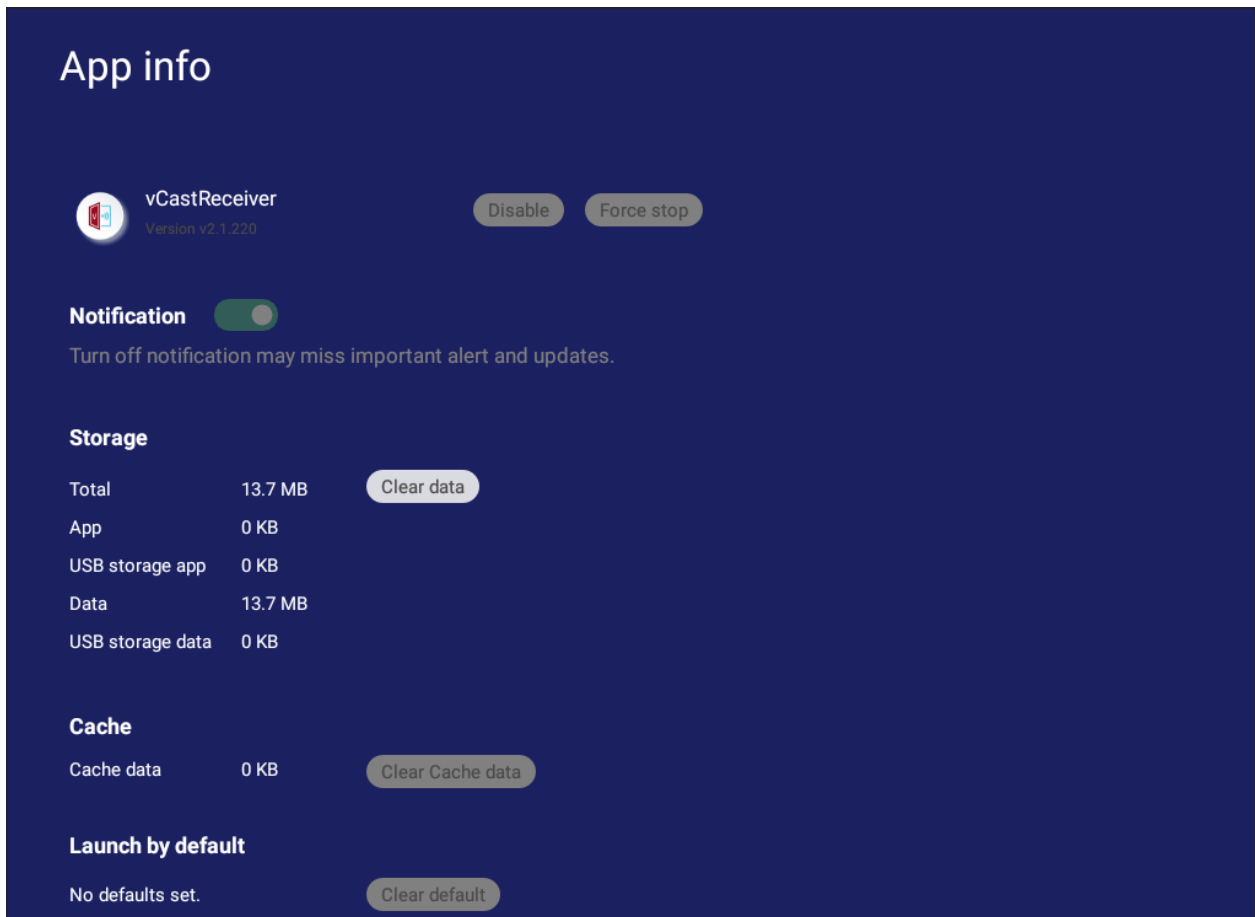

System

View and adjust **Storage**, **Security**, **System Update**, and **About device** settings.

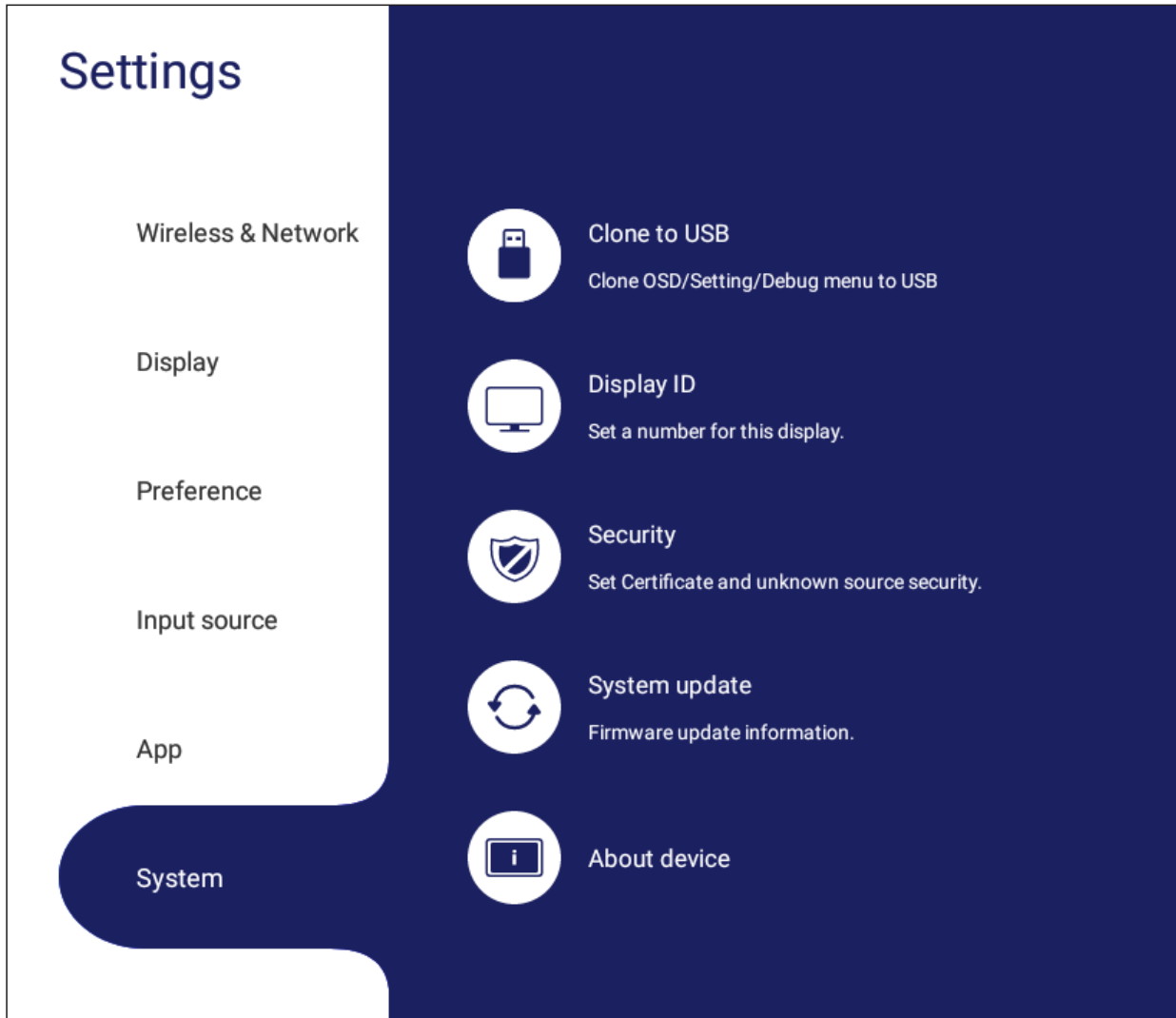

Clone to USB

Copy settings to an external USB drive.

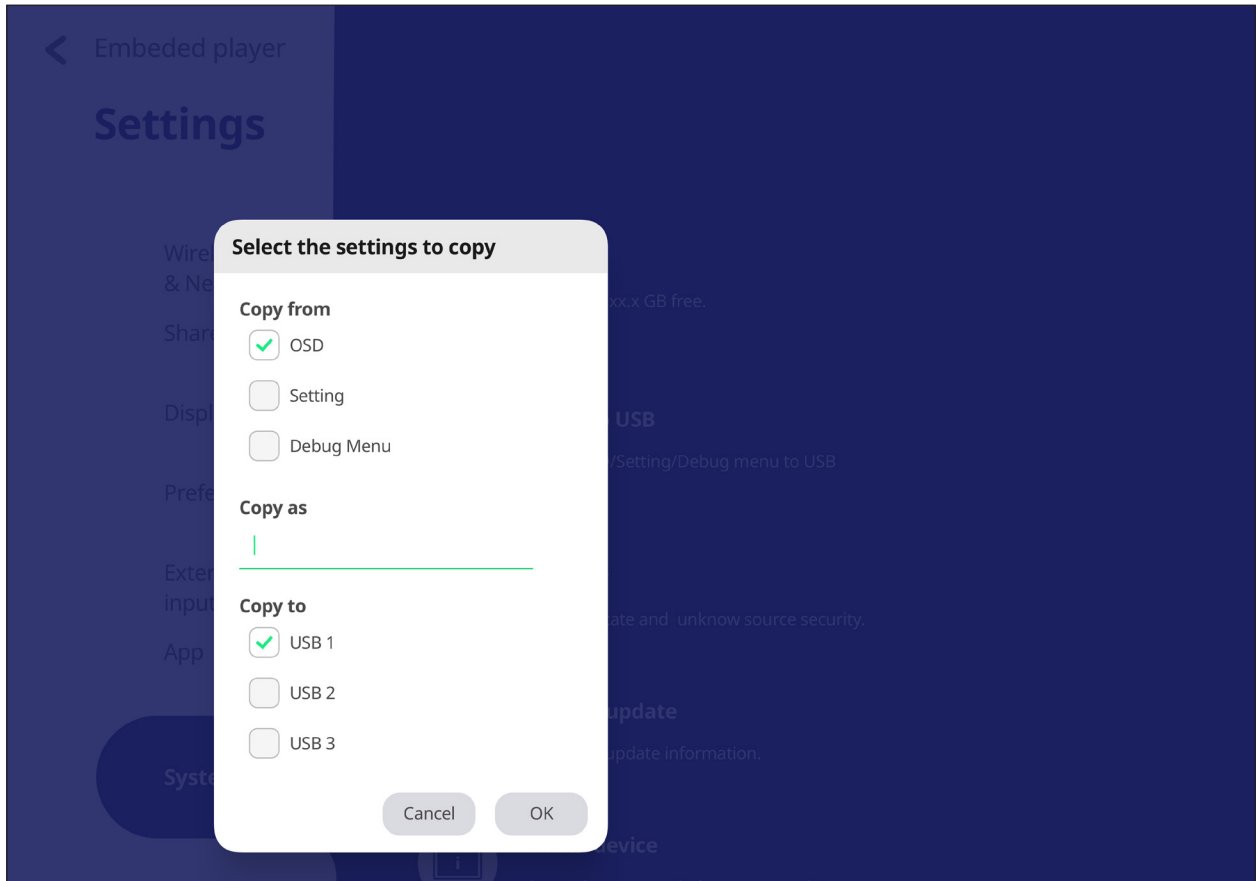

Display ID

Assign a number to remote control the display by RS-232/LAN.

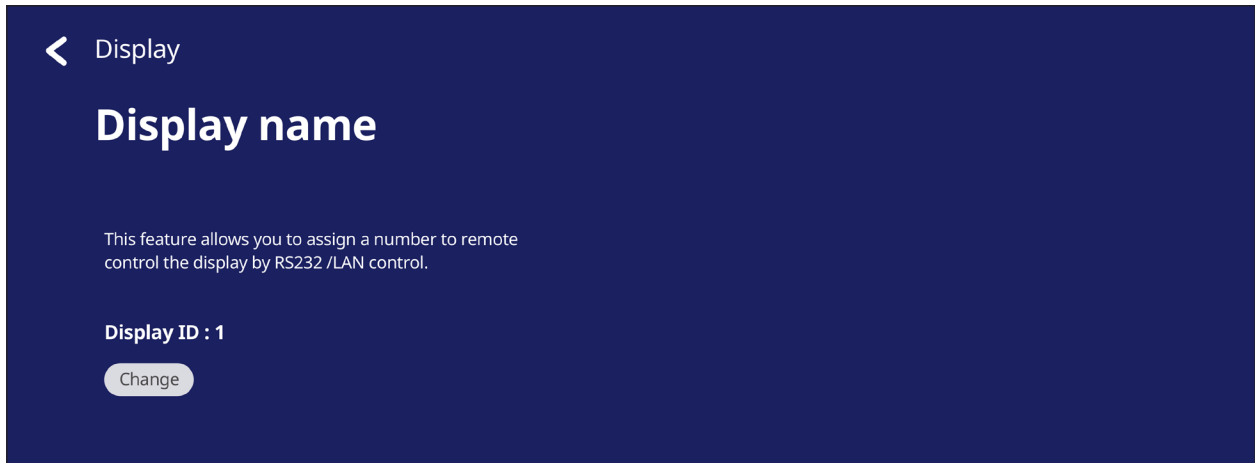

- To assign or change the Display ID, tap **Change** and input a number.

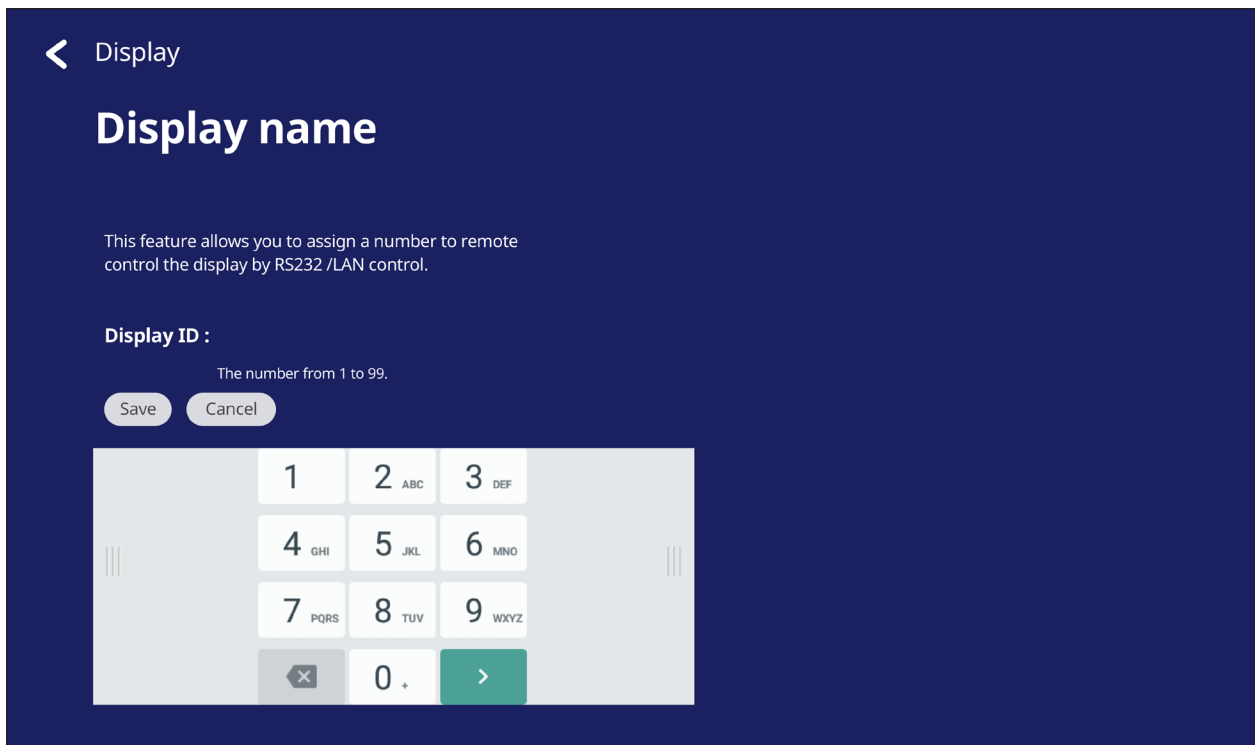

NOTE: The Display ID is for RS-232 users, and the range is 01~99.

Security

Review **Certificate**, **Trusted Credential** storage, and **Unknown sources** install settings.

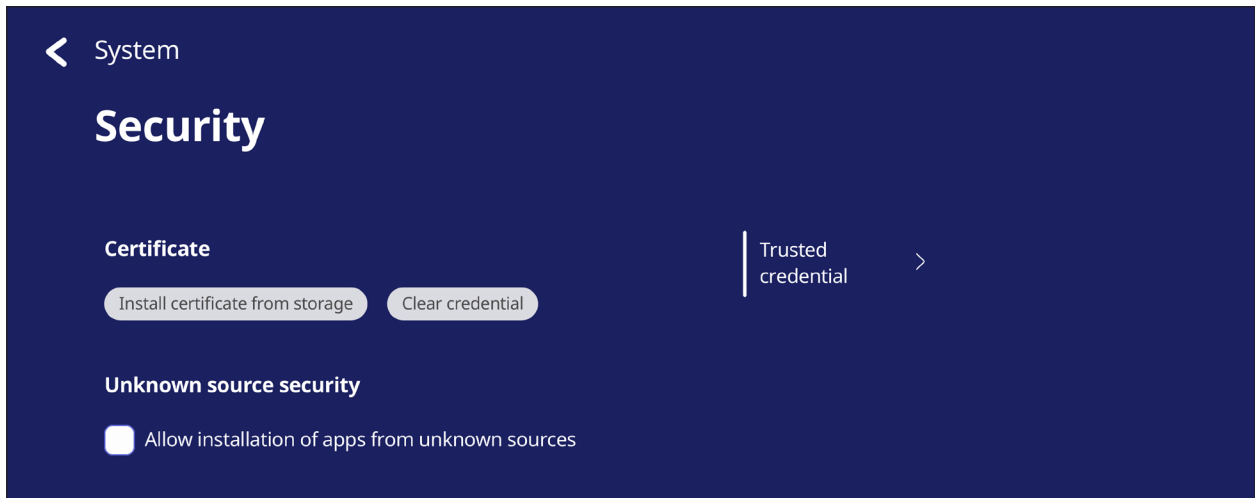

- Tap on **Install certificate from storage** to add additional certificates.

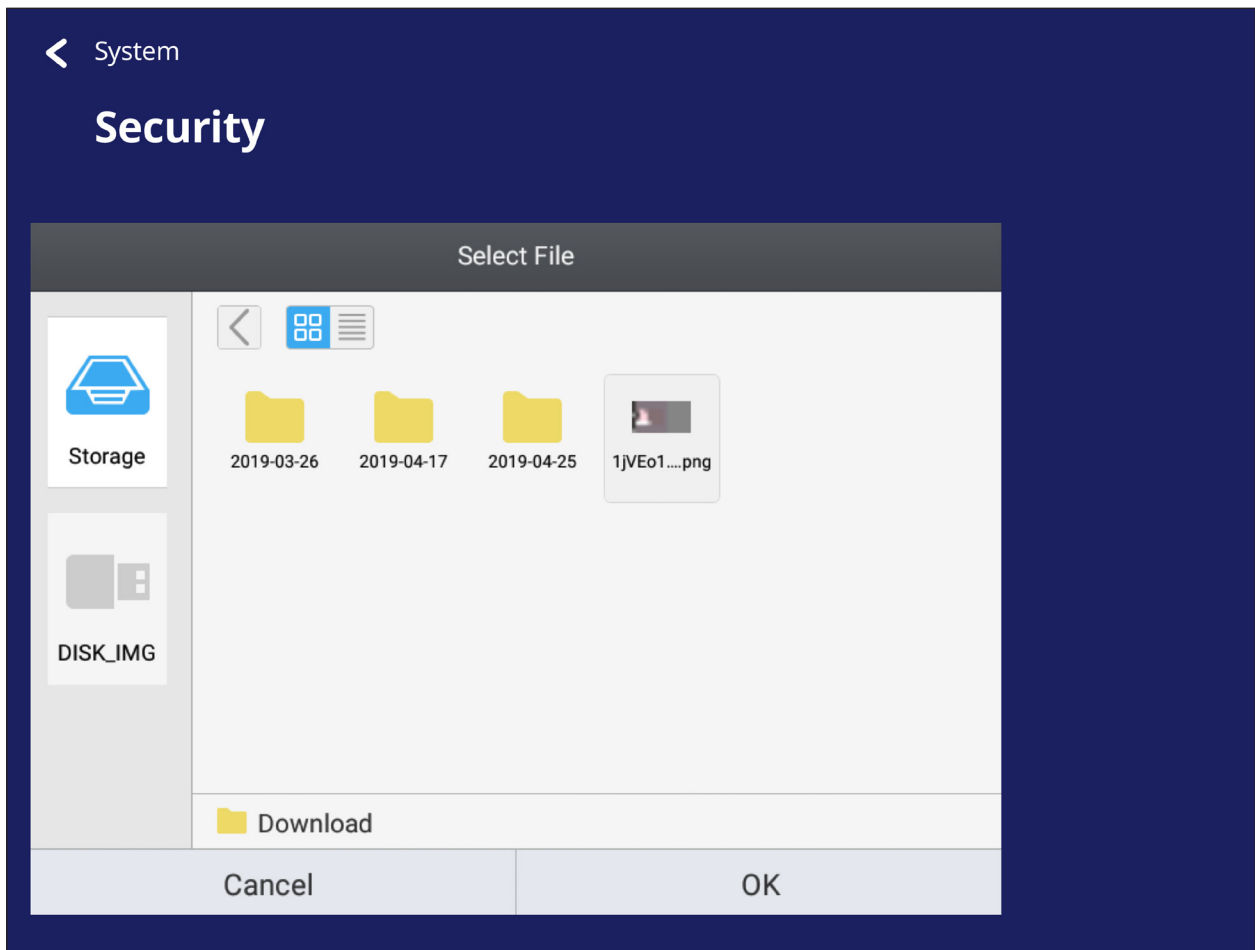

- Selecting **Clear Credentials** will remove all manually installed credentials.

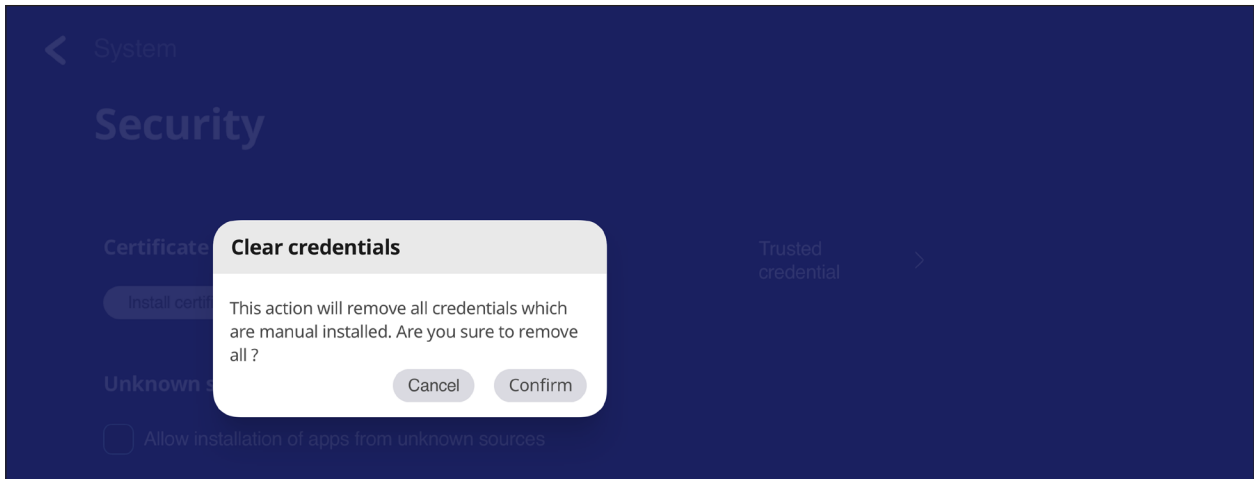

NOTE: Pre-loaded credentials cannot be cleared.

- Under **Trusted Credentials** view and edit all trusted and installed CA certificates.

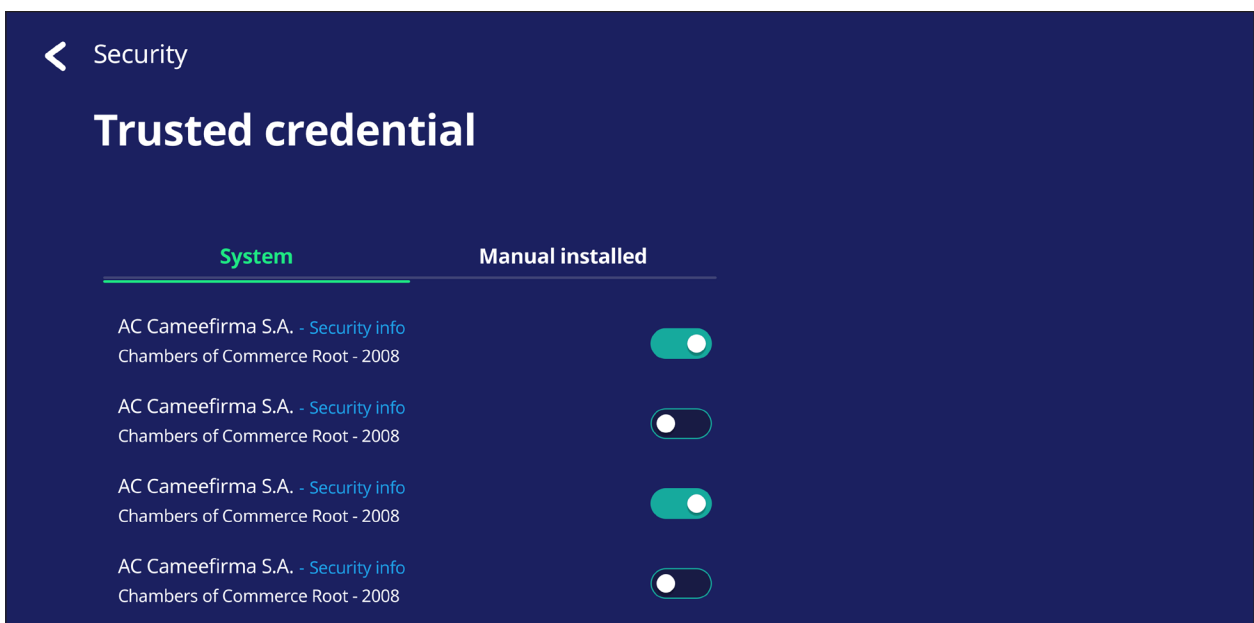

- Tapping on a credential will provide more detailed information.



- Allow the installation of applications from unknown sources by selecting the box under **Unknown source security**.

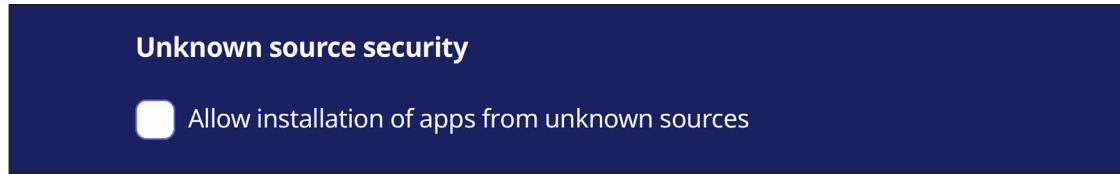

NOTE: Apps from unknown sources may not be compatible or work properly.

System Update

The ViewBoard automatically searches for software updates whenever connected to the Internet (OTA). With just one click, users can update their version of ViewBoard software.

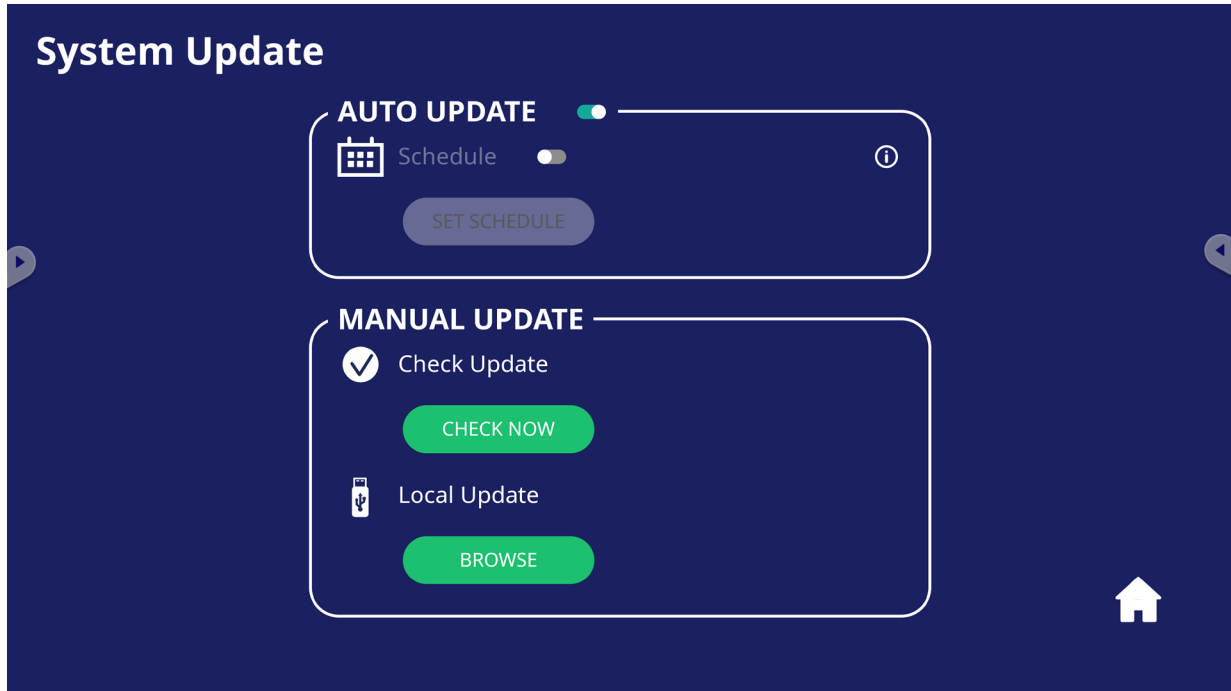

| Item | Description |
|----------------------|--|
| Auto Update | When the display is off, the system will automatically check for a new version. If a new version is found, the system will automatically update. After the update is complete, the system will turn off. |
| Schedule | Set the update time. |
| Manual Update | Update the software manually. |
| Check Update | Check for any available updates. |
| Local Update | Update the system from an external USB device. |

About Device

Display Embedded Player information, **Legal information**, and **Asset Tagging**.

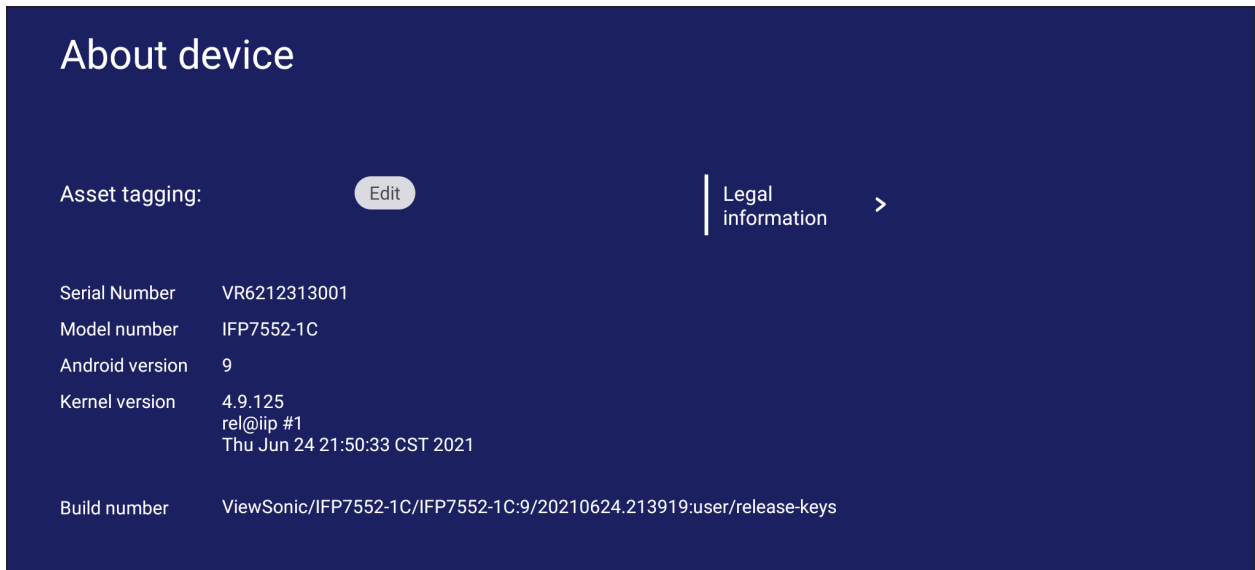

- By selecting **Edit**, the asset information can be adjusted.

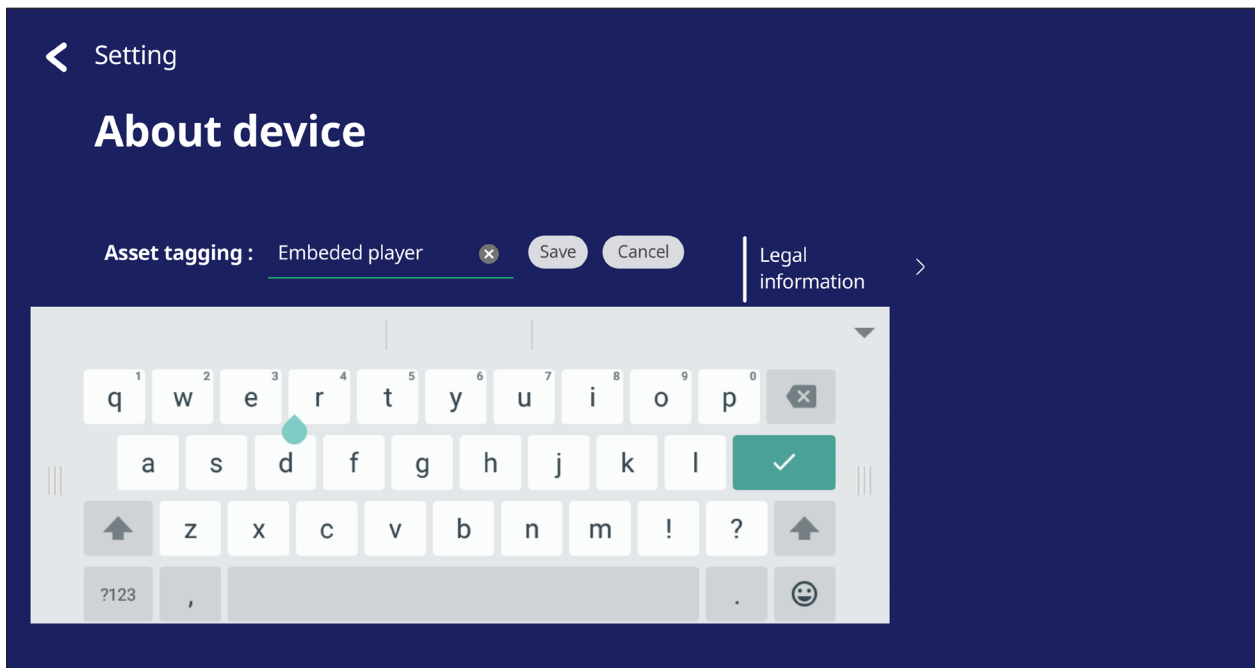

- Tap on **Legal information** to check open source licenses.

















> Embedded Applications and Settings

Embedded Digital Whiteboarding App

Within ViewBoard, ViewSonic offers the embedded digital whiteboarding app, Whiteboard.

Whiteboard

Floating Bar

| | | | |
|---|---|--|--|
|  |  | Move the Floating Bar. | |
|  |  | Switch between presentation and preparation modes. | |
|  |  | Paste from the clipboard onto the canvas. | |
|  |  | Click to open the web browser | |
|  |  | Go to the previous canvas. | 1. New Whiteboard File 2. Open File 3. Save File |
|  |  | Go to the next canvas. | |
|  |  | Add a new canvas. | |

Toolbar

| | | | |
|---|---|--|--|
|  |  | Full Screen Capture | |
|  |  | Toolbar Move Button | Select and hold to move the toolbar to the left side, right side, or bottom of the screen. |
|  |  | File Button | |
| | |  | |
| | | 1. New Whiteboard File 2. Open File 3. Save File | 4. Save as File 5. Export |
|  |  | Import resources (image, video, audio, etc.) to the whiteboard. | |
|  |  | Infinite Canvas Button | Select – Use two hands to zoom in/out on/of the working panel. |
|  |  | Selection Button | Select objects, text, and pictures to get other tools. |
|  |  | Pen Button | Writing tools, changing colors, transparency, thickness, etc. |
|  |  | Eraser to erase objects or clear the page. | |
|  |  | Shape/Line Button | Create shapes, select shape colors, insert arrows. |
|  |  | Text Box | Creates a Text box. |
|  |  | Undo Button | Undo previous actions. |
|  |  | Redo Button | Redo previous actions. |
|  |  | Page Toggle Button | Select pages, sort pages, delete pages. |
|  |  | Show or hide the current host information. | |
|  |  | Whiteboard background management menu. | |

ViewBoard Cast

Working with ViewBoard® Cast software, the vCastReceiver app, will allow the ViewBoard® to receive vCastSender laptop screens (Windows/Mac/Chrome) and mobile (iOS/Android) users' screens, photos, videos, annotations, and camera(s).

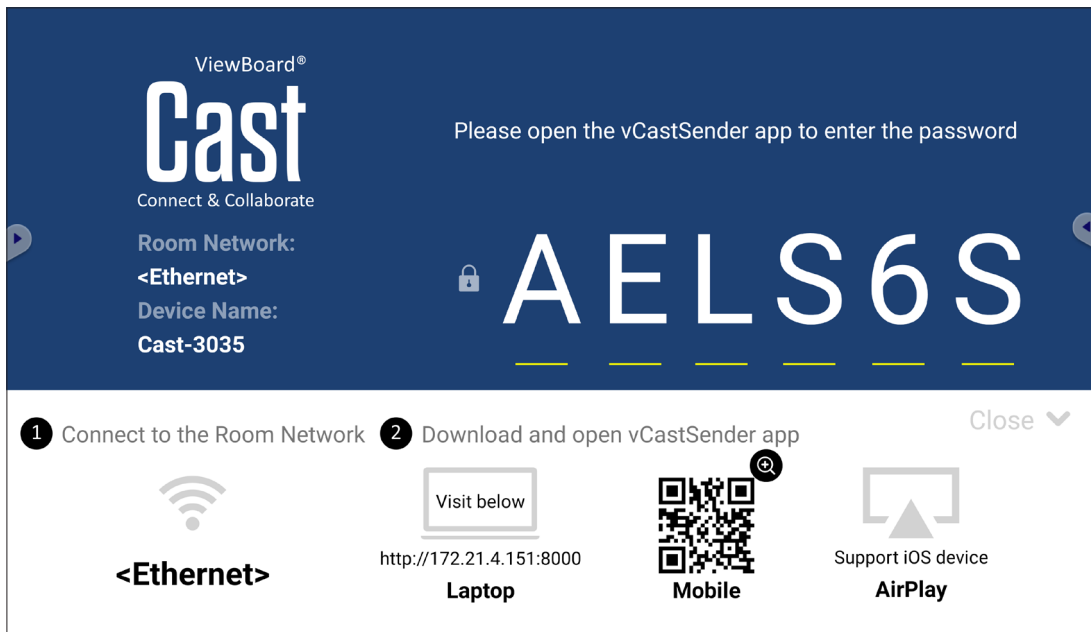

Network Information

- ViewBoard® Cast software, laptops, and mobile devices can connect to both the same subnet and across the subnet network.
- Connected devices will show up under “Device List” on the same subnet connection.
- If the device does not show up under “Device List”, users will need to key-in the on-screen PIN-code.

ViewBoard Cast is a wireless peer to peer data communication, therefore the below port settings are required:

Ports:

- CP: 56789, 25123, 8121, and 8000
- UDP: 48689 and 25123

Port and DNS activation:

- Port: 8001
- DNS: h1.ee-share.com

Cast Sender from Windows-based, Macbook, and Chrome devices.

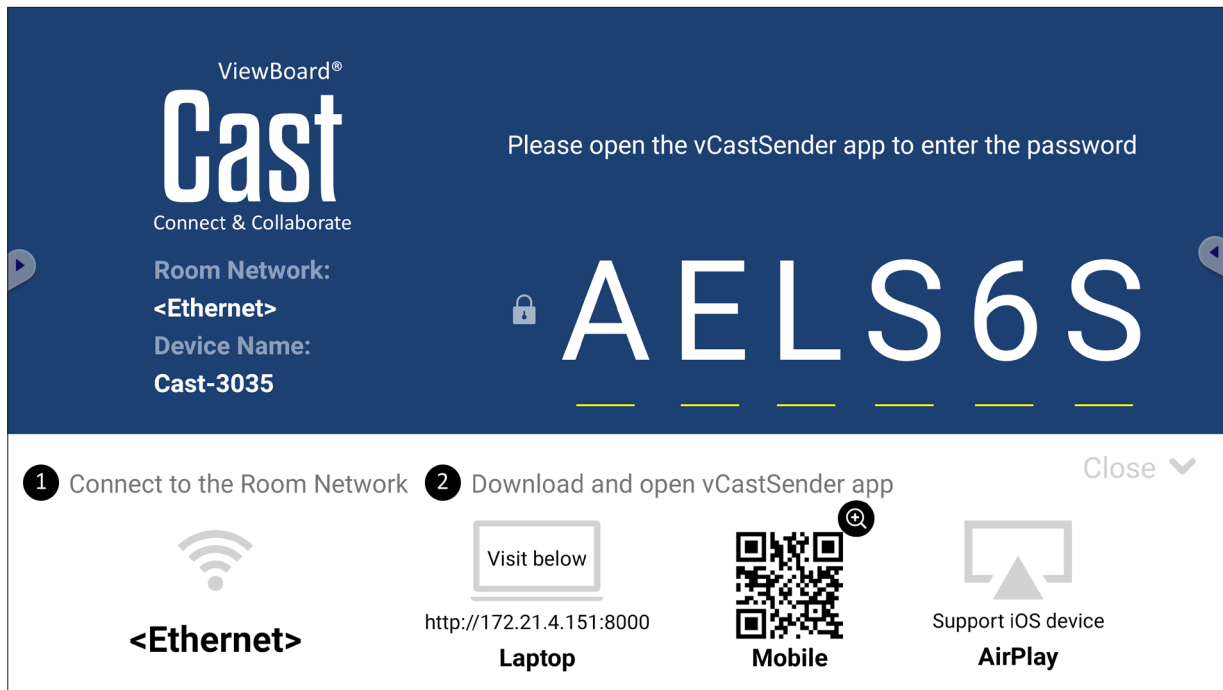

Mac, Windows, Chrome Devices:

1. Make sure your device is connected to the same network as the ViewBoard.
2. Visit the address that is shown on the ViewBoard to download the application.
3. Launch the application and enter the PIN Code or click Device List, then click the connect icon next to the Device Name.

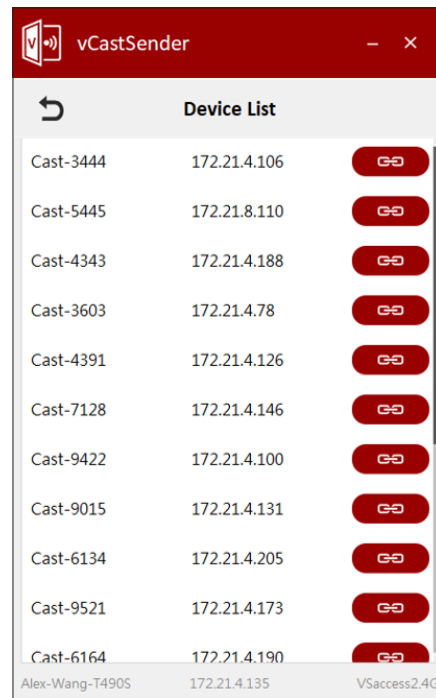
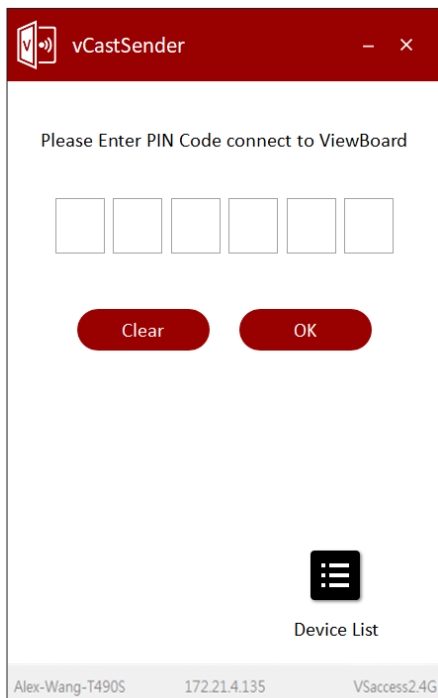

Cast Sender from Mobile Devices: iOS-based (iPhone, iPad) and Android OS based phone/tablet.

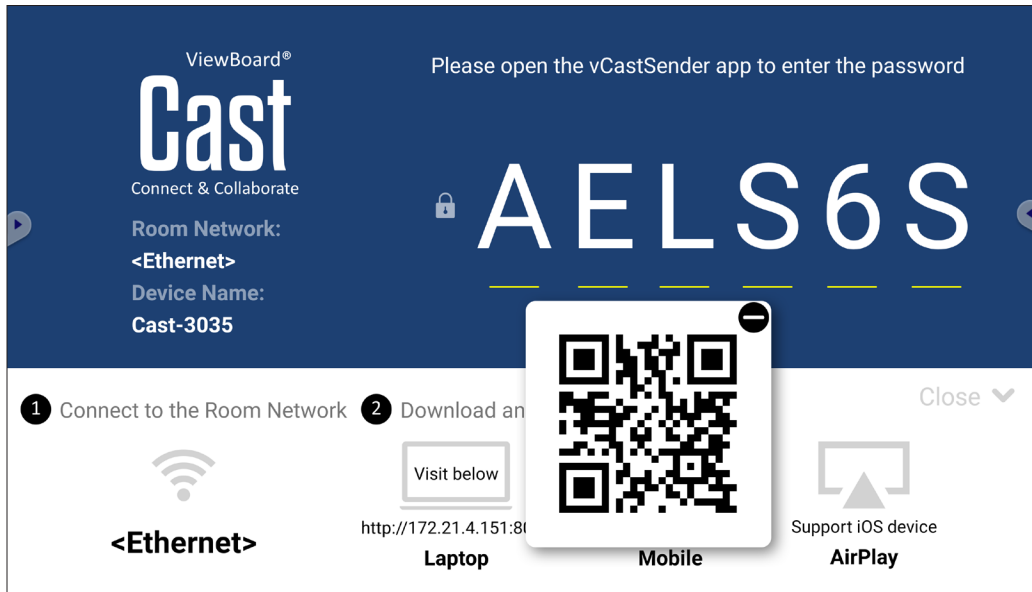

Android/iOS:

1. Make sure your device is connected to the same network as the ViewBoard.
2. Scan the QR Code that is shown on the ViewBoard to download directly from the server, or download from the Google Play Store or the Apple Store.
3. Launch the application and select the correct Device Name and input the pin to connect. You can also directly input the pin-code displayed on the ViewBoard to connect.

Apple AirPlay®:

1. Make sure your device is connected to the same network as the ViewBoard.
2. Directly open AirPlay and select the Device Name to connect.
3. Another "AirPlay Password" will be generated on-screen for connection.

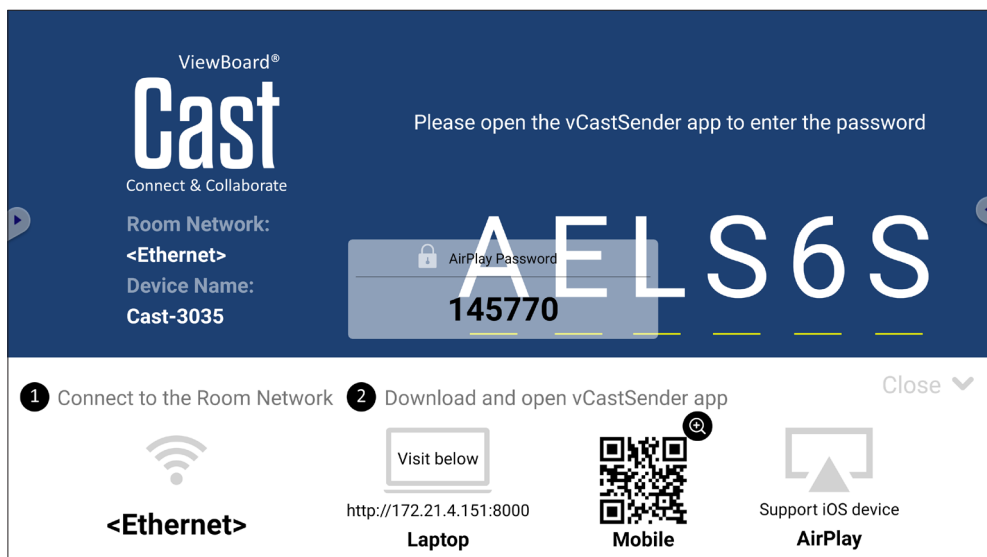

Screen Recorder

Capture everything that is displayed on screen in a video format.

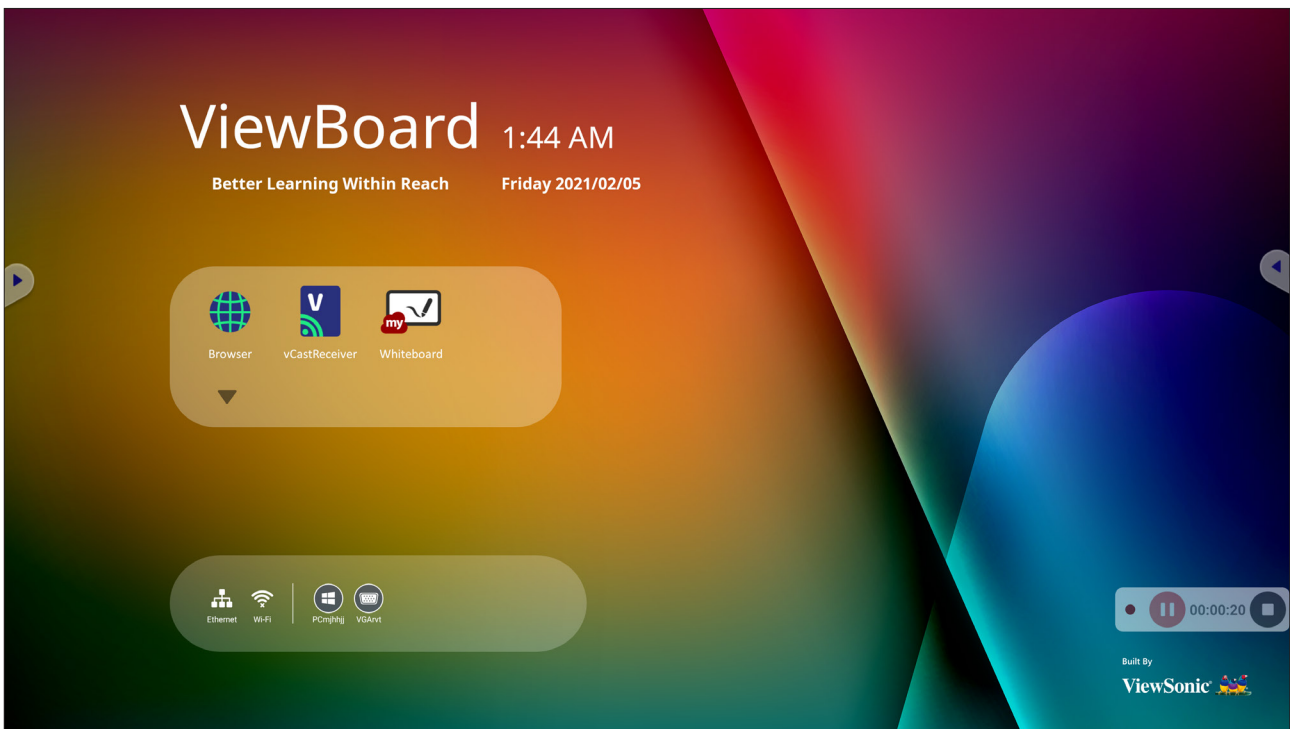

To launch the Screen Recorder application:

1. Select the Screen Recorder icon in the application drawer.
2. Tap the record icon  and select the preferred recording configurations. Then tap the check mark.

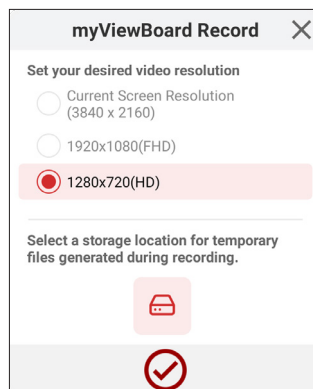

3. Select *Start Now* and a three (3) second countdown will begin. Screen recording will begin immediately after the countdown.
4. After stopping the recording, you will be able to preview the video, save it, or discard it.

Air Class

Display quiz questions on the ViewBoard and allow up to 30 mobile users to submit answers remotely. Whether deploying single or multiple choice questions, the ViewBoard will record the results for each device being used.

Air Class

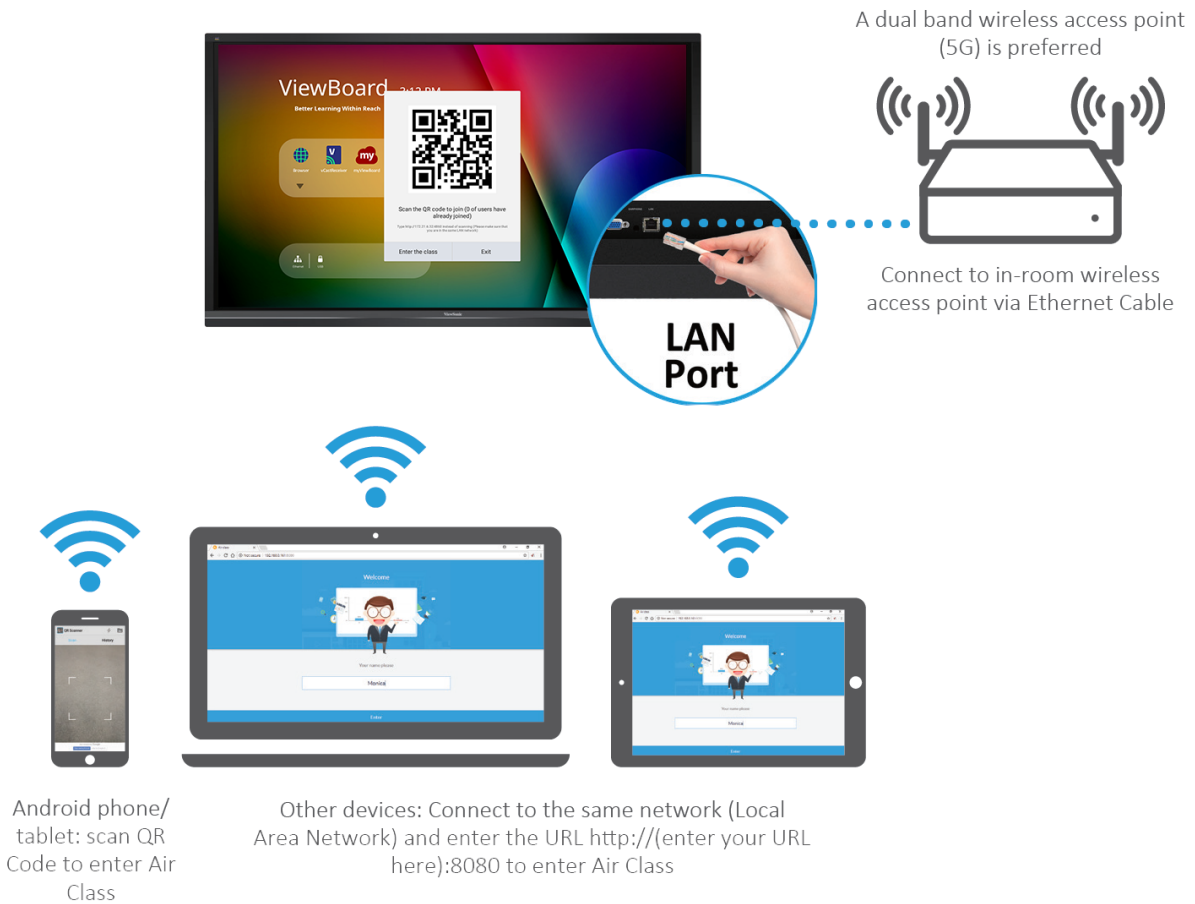

Network Information

- PC (Windows/Mac/Chromebook) and tablet/mobile (iOS/Android) devices, as well as the ViewBoard need to be linked to the same LAN network subnet.
- Ports: TCP 8080





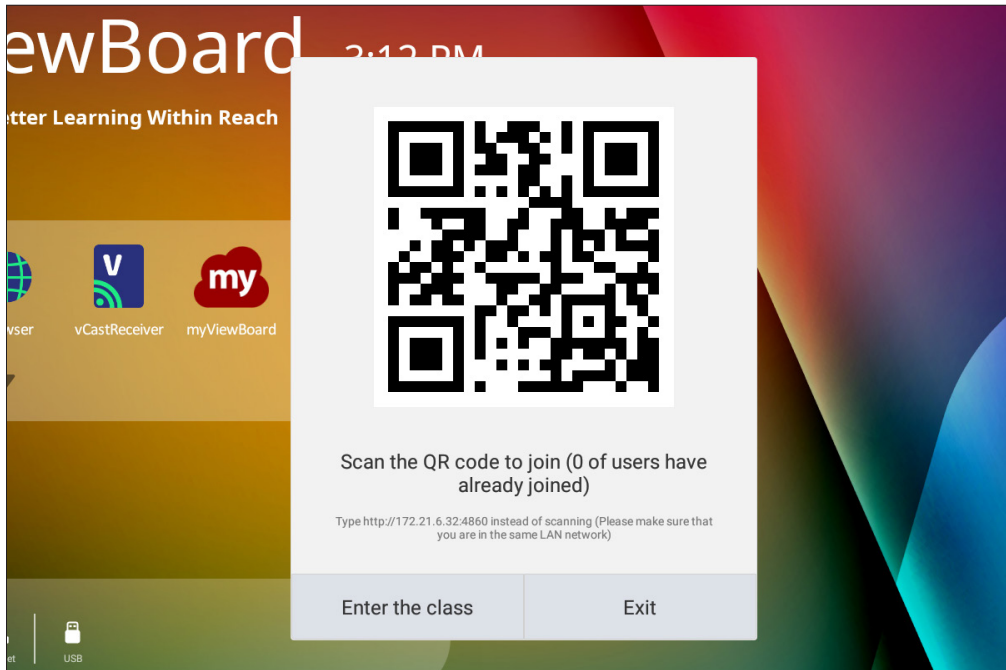

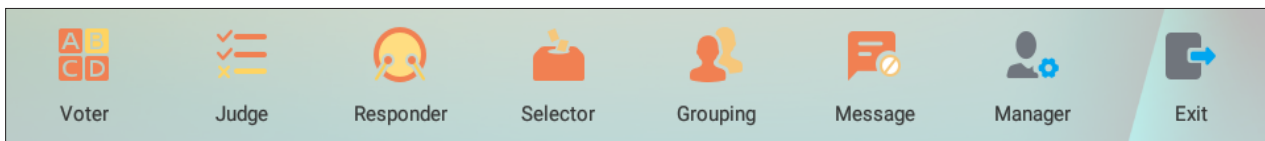

To launch Air Class:

1. Tap the tool bar trigger icon and select the more tools icon. Then select the Air Class icon.
2. Select “Enter the class”.



3. Choose from the available interactive functions at the bottom of the screen.



| Item | Description |
|--|--|
|  Voter | Single and Multiple choice questions. |
|  Judge | True/False questions. |
|  Responder | Race to answer first. |
|  Selector | Randomly select a participant. |
|  Grouping | Assign participants to groups. |
|  Message | Allow/Deny participants to direct message the ViewBoard. |
|  Manager | Add participants. |
|  Exit | Exit Air Class. |

Voter

1. Select the **Single choice** or **Multiple choice** icon to select the preferred answer type.

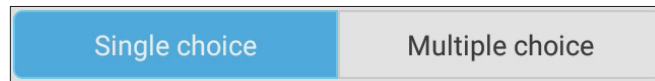

2. Tap **BEGIN VOTING** to let the participants start.

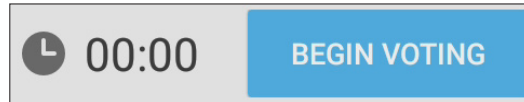

3. After the participants are finished and press **OK**, the ViewBoard will show the participant's name on screen.

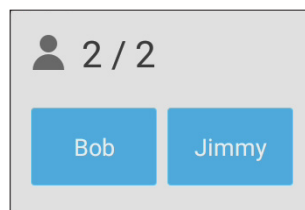

4. Tap **FINISH VOTING** to close the quiz.

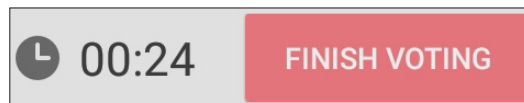

5. Then the participants' "Answer Statistics" will be displayed.

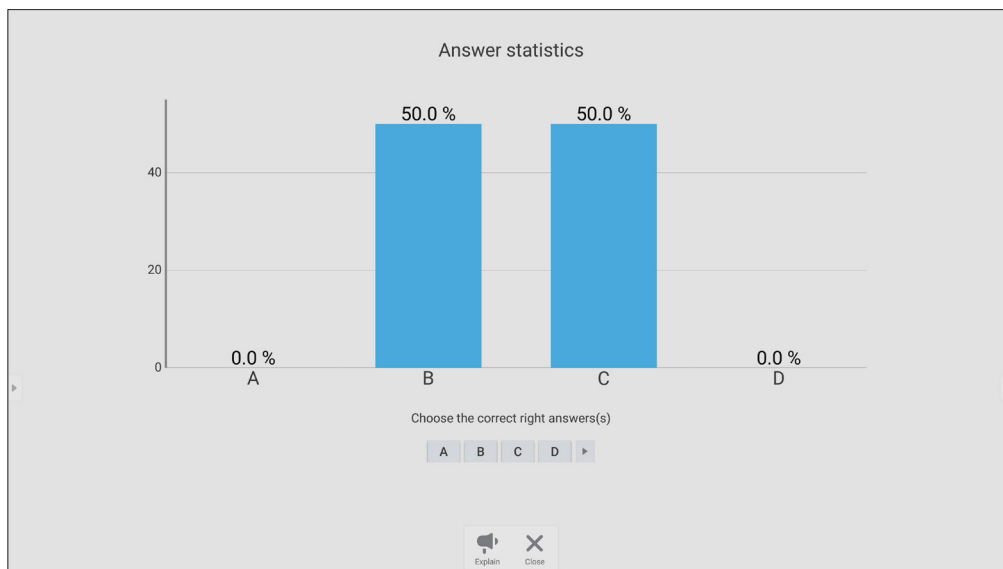

6. Choose the right answer to show the correct rate.

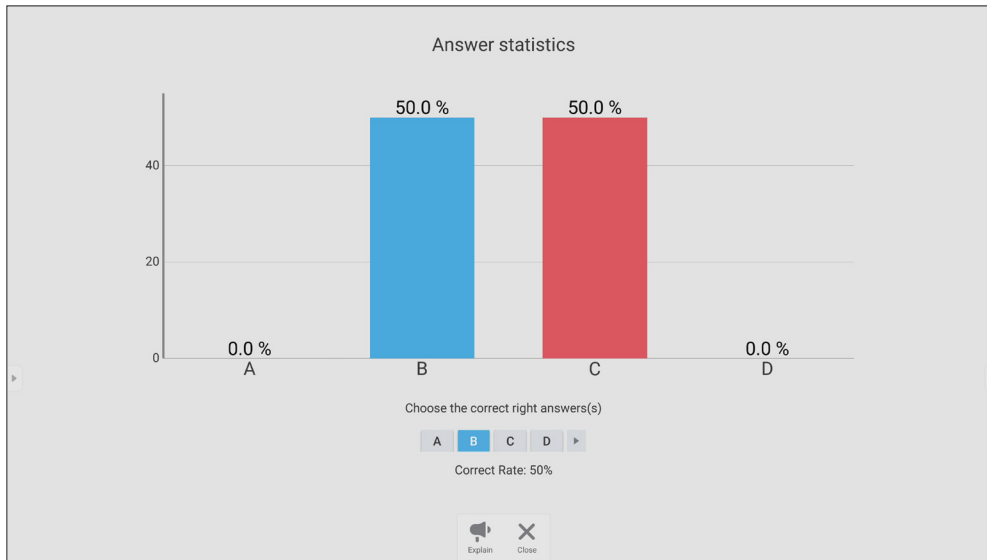

7. Click the Explain icon () to further analyze the topic.

The image shows a digital whiteboard interface. At the top, the equation $2 \times 3 =$ is written in white. Below it, four options are listed: A. 7, B. 6, C. 9, and D. 4. The numbers 7, 6, 9, and 4 are written in yellow. On the left side, there is a vertical toolbar with various drawing and editing tools. At the bottom, there is a horizontal toolbar with icons for "Voter", "Judge", "Responder", "Selector", "Message", "Manager", and "Exit". In the bottom right corner, a small window titled "Answer statistics" is embedded, showing a bar chart with the same data as in the first figure: B and C at 50.0%, and A and D at 0.0%.

Judge

1. Tap **BEGIN VOTING** to let the participants start a True/False questionnaire.

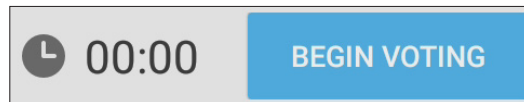

2. After the participants are finished and press **OK**, the ViewBoard will show the participant's name on screen.

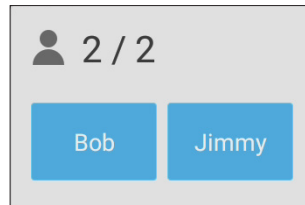

3. Tap **FINISH VOTING** to close the quiz.

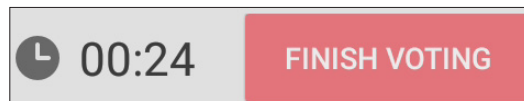

4. Then the participants' "Answer Statistics" will be displayed.



1. Choose the right answer to show the correct rate.

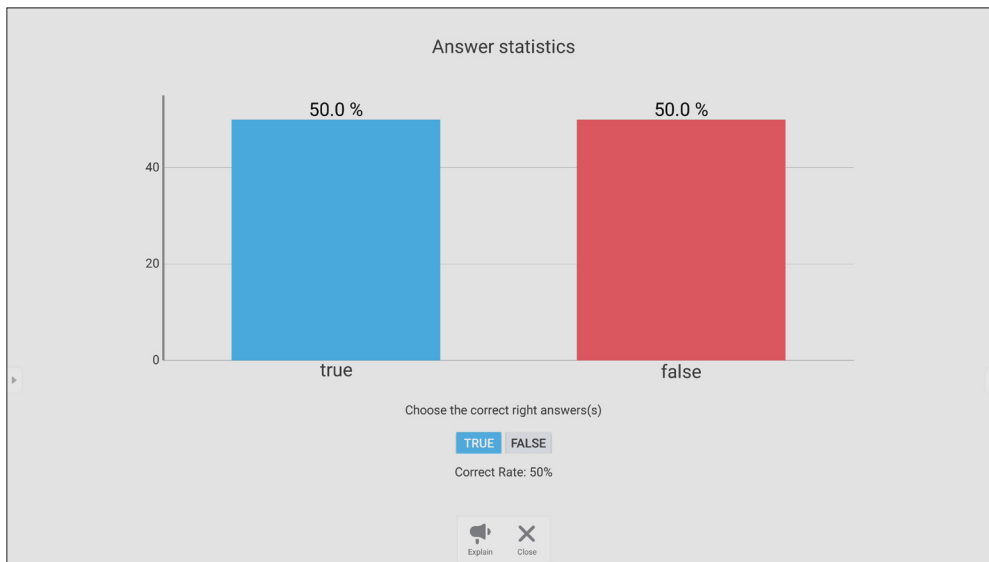

2. Click the Explain icon () to further analyze the topic.

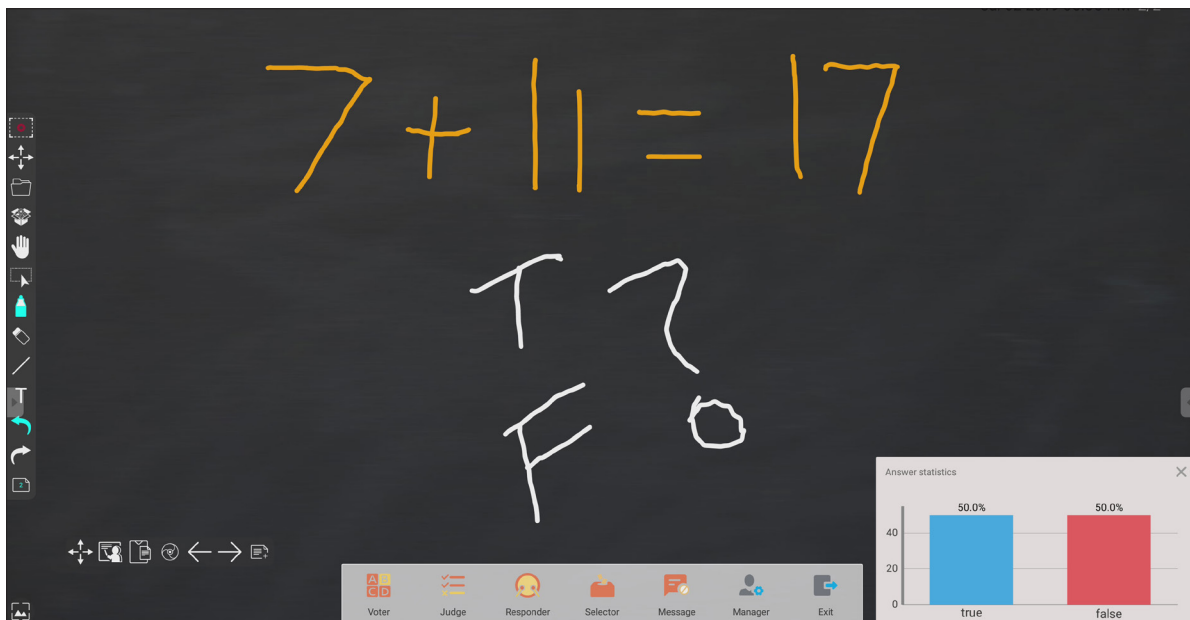

Responder

Participants race to select their answer and tap **OK** to submit their answer.

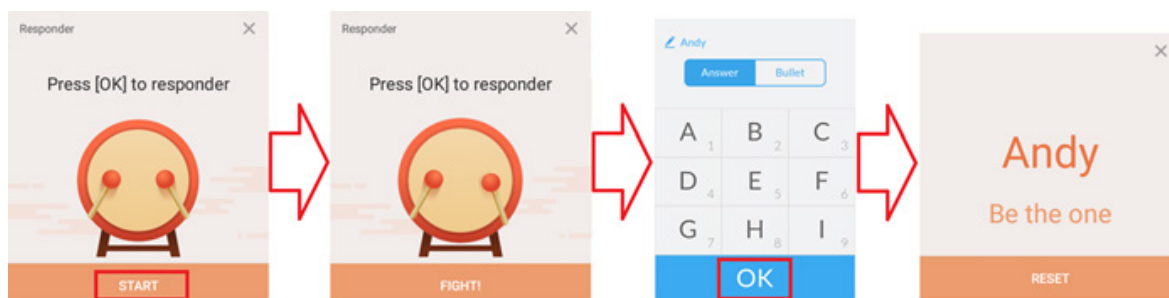

Selector

1. Select the “Selector’ icon.
2. Set the number of participants to be selected.

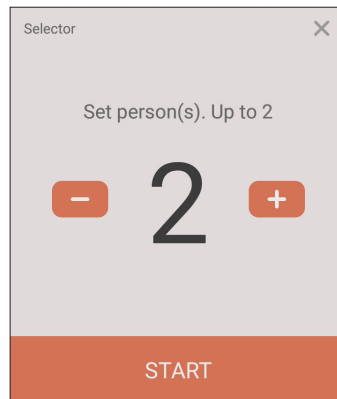

NOTE: The number of participants that can be selected will be based on the total number of participants.

3. Tap **START** to start the random selection.

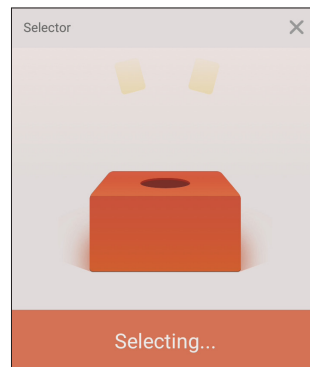

4. The selected participant’s name will then be displayed.

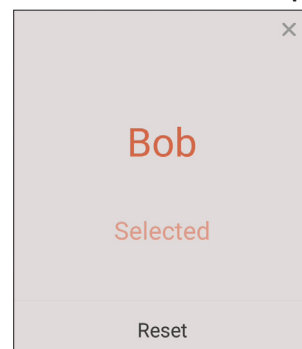

Grouping

Select the icon to assign participants to groups.

Message

To allow messaging:

1. Tap the “Message” icon to enable the function.
2. Participants select “Message” to change to the message interface.

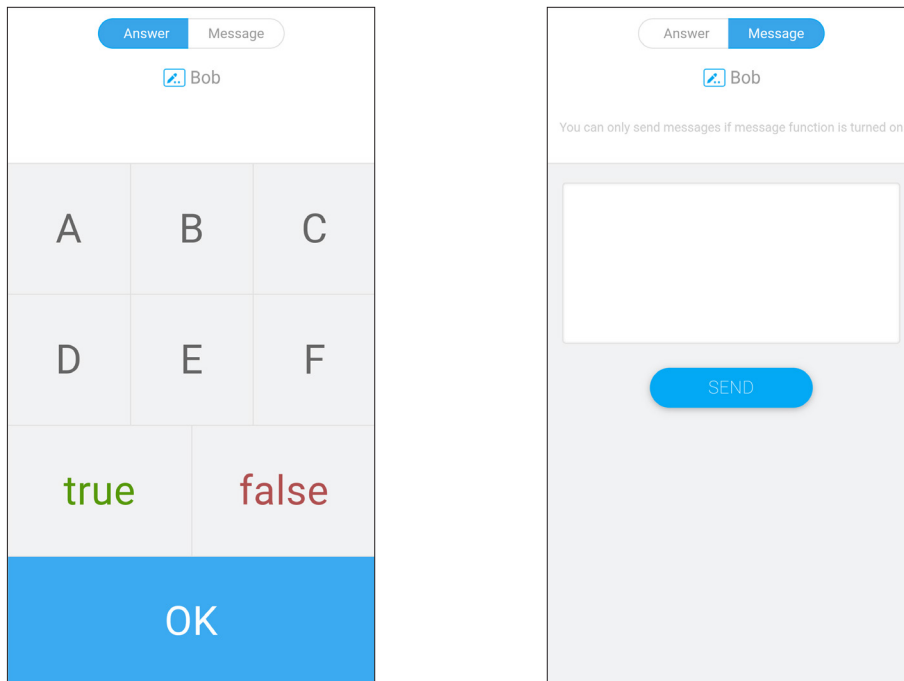

3. Participants key in their message then select **SEND**.

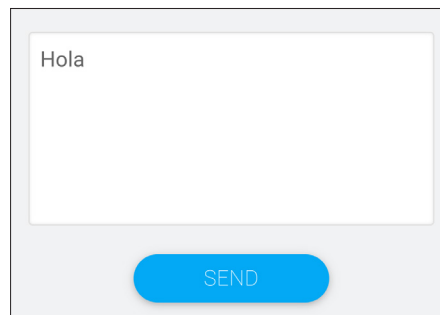

4. The message will scroll across the top of the ViewBoard.

Manager

Select the icon to let more participants join the class.

Exit

Select to exit the Air Class interface.

Other Default Applications

vSweeper

Clear unnecessary data and unwanted files.

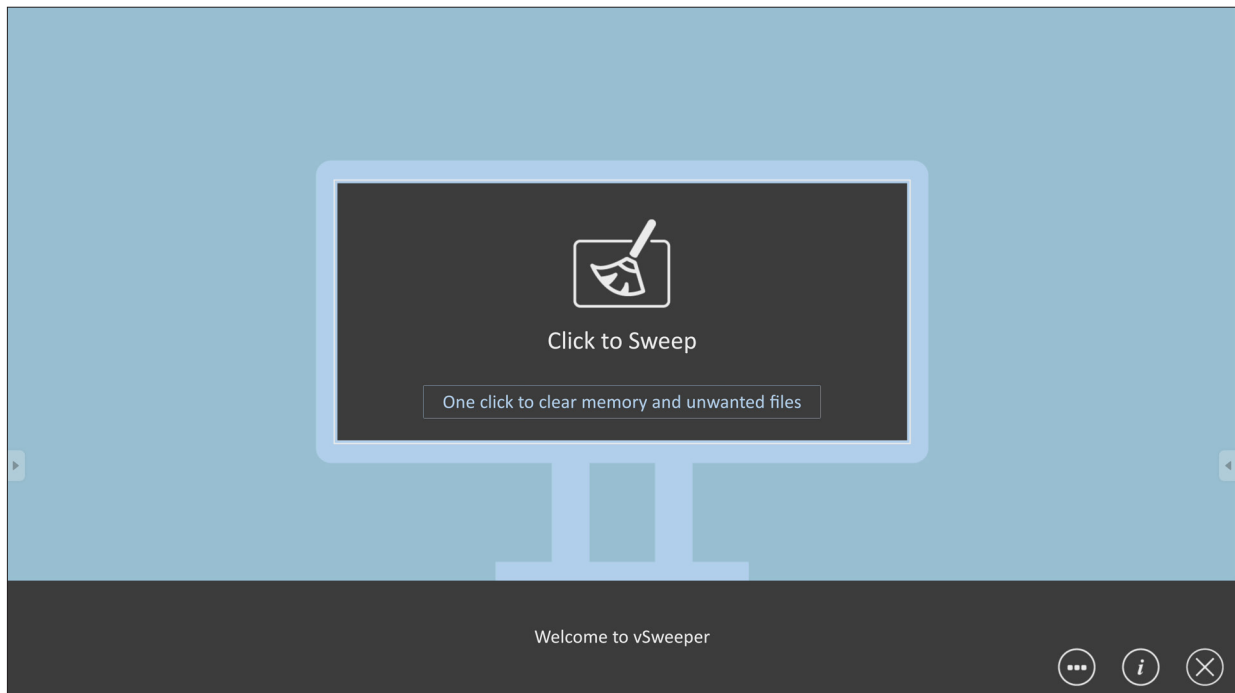

Advanced Settings can also be customized to the user's needs.

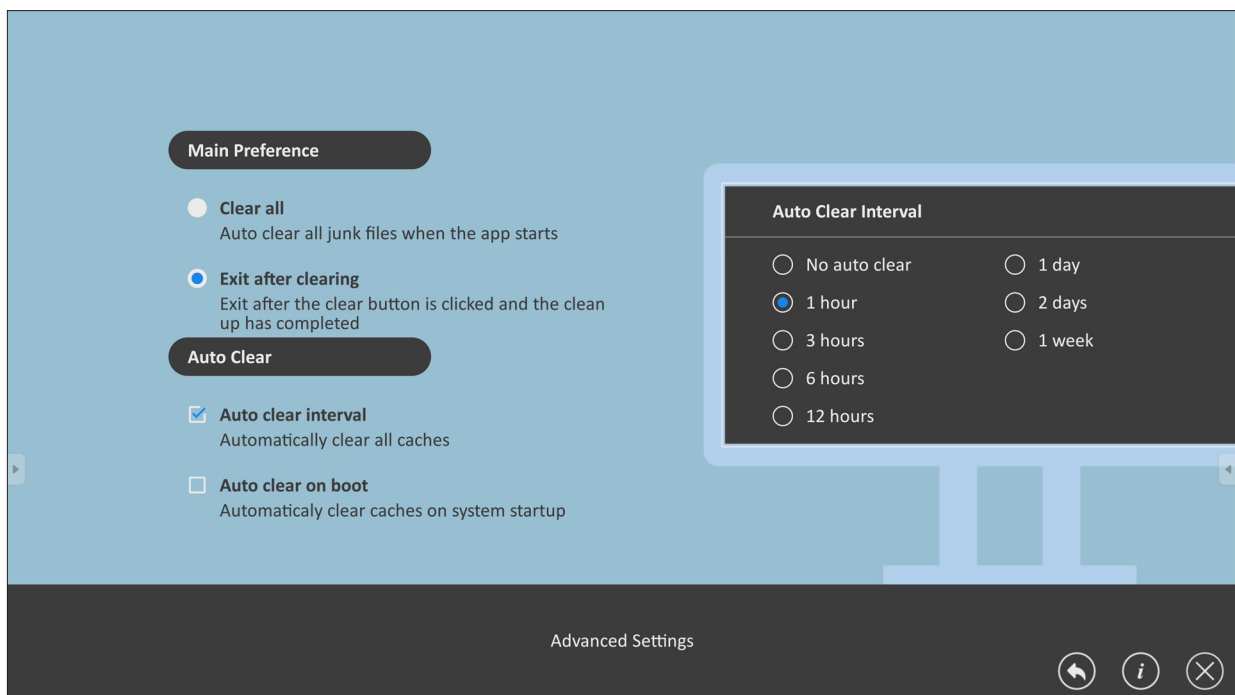

Screen Lock

Set a screen lock password and enable screen lock.

NOTE: If the user forgets the password, use the remote control and press **INPUT-0-2-1-4** to restore the password to default.

To set a screen lock password:

1. Go to: **Settings > Personal > Password for screen lock**, or select the Screen Lock icon in the apps list.

NOTE: If you select the Screen Lock icon and no password has been set, the below prompt will appear:

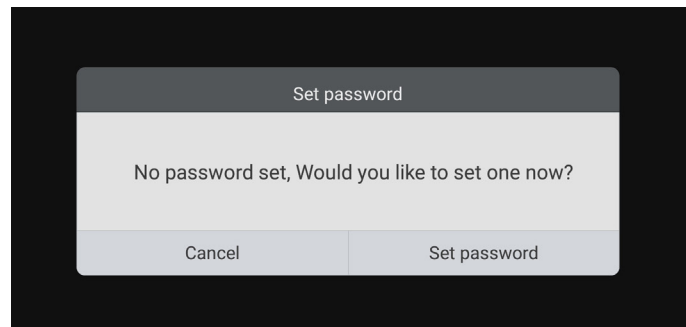

2. Select **Set Password**, and input a new four (4) digit password. Then select **OK**.

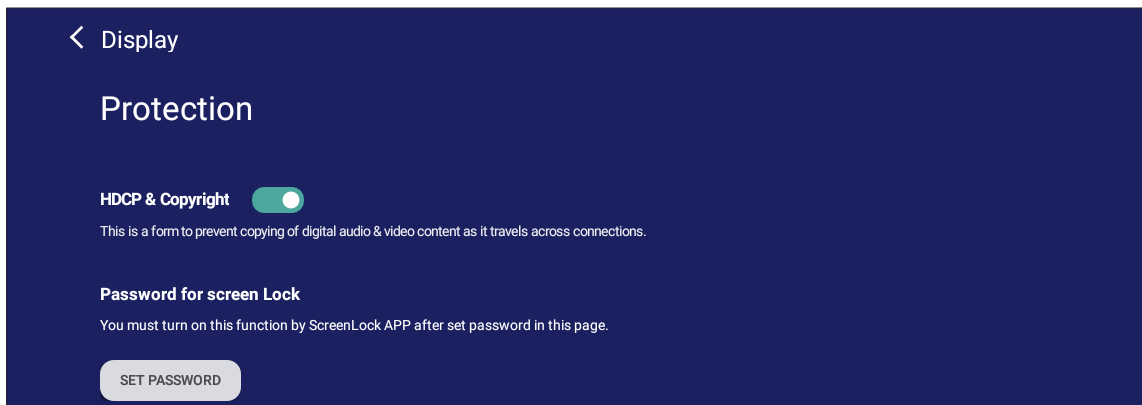

3. Now when selecting the Screen Lock icon, the screen will be locked.



Chromium

Web browser for surfing the Internet.

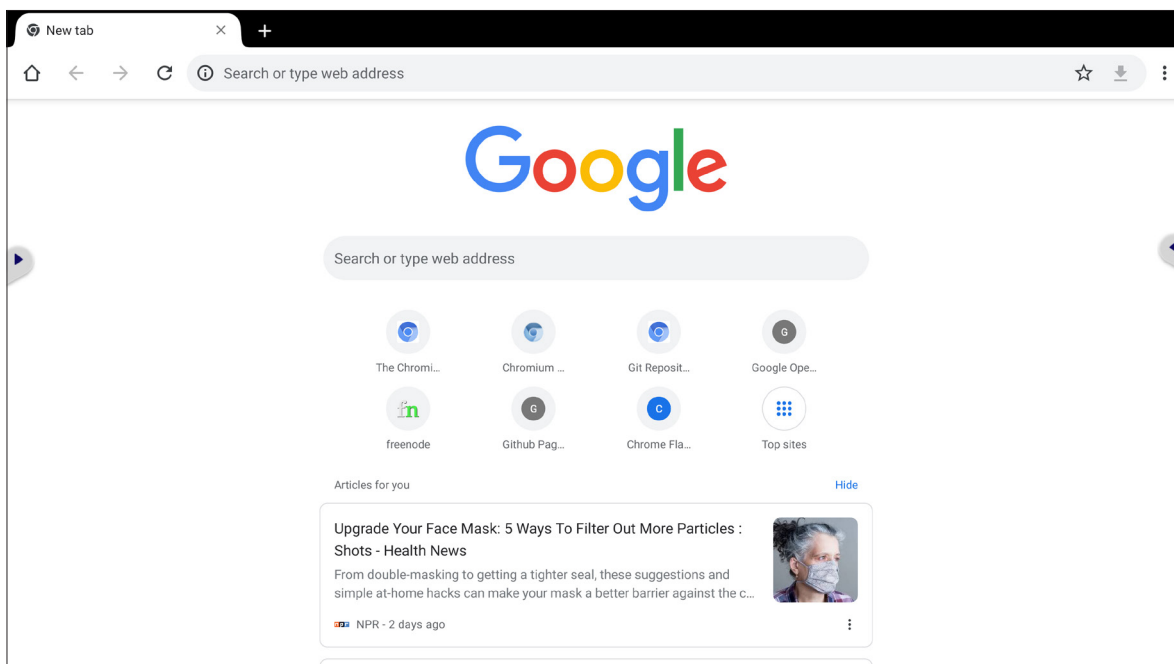



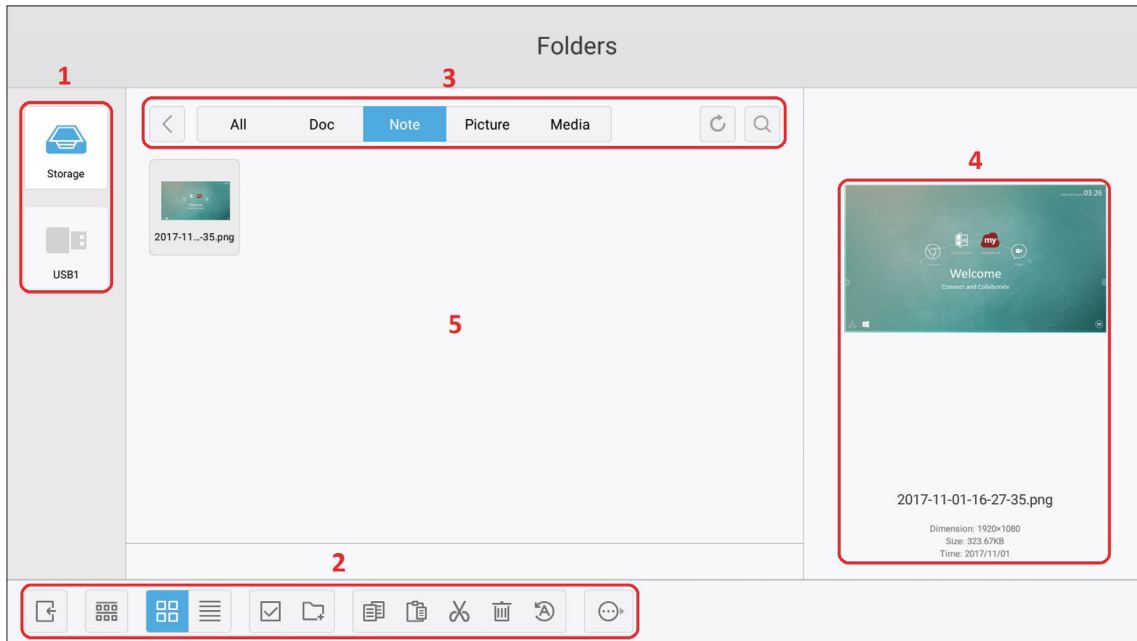









Folders



1. Storage Device Display

Select the appropriate storage device.

2. Icons

| Item | Description |
|--|--|
|  Exit | Click to exit. |
|  Sort | Click to sort file. |
|  Thumbnail | Click to display file by thumbnail mode. |
|  List | Click to display file by list mode. |
|  Select | Click to select file. |
|  Add folder | Click to add folder. |
|  Copy | Click to copy file. |
|  Paste | Click to paste file. |
|  Cut | Click to cut file. |
|  Delete | Click to delete file. |
|  Rename | Click to rename file. |
|  More | Click to show more functions. |

3. File Type Menu

| Item | Description |
|---------|---|
| All | All types |
| Doc | OFFICE files |
| Note | Image stored by myViewBoard, Side Tool Bar, and remote control Screen Capture button. |
| Picture | Image files |
| Media | Audio and Video files |

4. File Information

Preview the image, show the image's name, size, resolution, and creation date.

5. Main Display Area

Display files of corresponding type.

> RS-232 Protocol

This document describes the hardware interface spec and software protocols of the RS-232 interface communication between ViewSonic LFD and a PC or other control units with RS-232 protocol.

The protocol contains three command sections:

- Set-Function
- Get-Function
- Remote control pass-through mode

NOTE: Below, “PC” represents all the control units that can send or receive the RS-232 protocol command.

Description

RS-232 Hardware Specification

ViewSonic LFD communication port on the rear side:

1. Connector type: DSUB 9-Pin Male (female or 3.5 mm barrel connector)
2. Use of crossover (null modem) cable for connection
3. Pin Assignment:

Male DSUB 9-Pin
(preferred)

1 2 3 4 5



6 7 8 9

Female DSUB 9-Pin

5 4 3 2 1



9 8 7 6

3.5 mm barrel
connector (alternative
for limited space)



| Pin # | Signal | Remark |
|-------|--------|---------------------|
| 1 | NC | |
| 2 | RXD | Input to Display |
| 3 | TXD | Output from Display |
| 4 | NC | |
| 5 | GND | |
| 6 | NC | |
| 7 | NC | |
| 8 | NC | |
| 9 | NC | |
| frame | GND | |

| Item | Signal | Remark |
|--------|--------|---------------------|
| Tip | TXD | Output from Display |
| Ring | RXD | Input to Display |
| Sleeve | GND | |

LAN Hardware Specification

ViewSonic LFD communication port on the rear side:

1. Connector type: 8P8C RJ45
2. Pin Assignment:

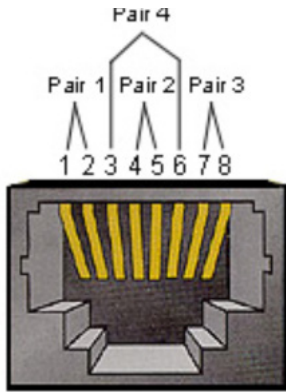

| Pin # | Signal | Remark |
|-------|--------|---------------------|
| 1 | TX+ | Output from Display |
| 2 | TX- | Output from Display |
| 3 | RX+ | Input to Display |
| 4 | BI_D3+ | For 1G case |
| 5 | BI_D3- | For 1G case |
| 6 | RX- | Input to Display |
| 7 | BI_D4+ | For 1G case |
| 8 | BI_D4- | For 1G case |
| frame | GND | |

RS-232 Communication Setting

- Baud Rate Select: 9600bps (fixed)
- Data bits: 8 bits (fixed)
- Parity: None (fixed)
- Stop Bits: 1(fixed)

LAN Communication Setting

- Type: Ethernet
- Protocol: TCP/IP
- Port: 5000 (fixed)
- WOL Port: 9 (fixed) for UDP ^{*3.2.0}
- Cross subnet: No
- Logon Credentials: No

Command Message Reference

PC sends to LFD command packet followed by “CR”. Every time PC sends control command to Display, the Display shall respond as follows:

1. If the message is received correctly it will send “+” (02Bh) followed by “CR” (00Dh)
2. If the message is received incorrectly it will send “-” (02Dh) followed by “CR” (00Dh)

Protocol

Set-Function Listing

The PC can control the Display for specific actions. The Set-Function command allows you to control the Display behavior at a remote site through the RS-232 port. The Set-Function packet format consists of 9 bytes.

Set-Function Description:

- Length:** Total Byte of Message excluding "CR"
- LFD ID** Identification for each of Display (01~98; default is 01)
ID "99" means to apply the set command for all connected displays. Under such circumstances, only ID#1 display has to reply.
The LFD ID can be set via the OSD menu for each Display.
- Command Type** Identify command type,
"s" (0x73h): Set Command
"+" (0x2Bh): Valid command Reply
"- " (0x2Dh): Invalid command Reply
- Command:** Function command code: One byte ASCII code.
- Value[1~3]:** Three bytes ASCII that defines the value.
- CR** 0x0D

Set-Function Format

Send: (Command Type="s")

| Name | Length | ID | Command Type | Command | Value1 | Value2 | Value3 | CR |
|-------------|--------|--------|--------------|---------|--------|--------|--------|--------|
| Byte Count | 1 Byte | 2 Byte | 1 Byte | 1 Byte | 1 Byte | 1 Byte | 1 Byte | 1 Byte |
| Bytes order | 1 | 2~3 | 4 | 5 | 6 | 7 | 8 | 9 |

Reply: (Command Type="+" or "-")

| Name | Length | ID | Command Type | CR |
|-------------|--------|--------|--------------|--------|
| Byte Count | 1 Byte | 2 Byte | 1 Byte | 1 Byte |
| Bytes order | 1 | 2~3 | 4 | 5 |

NOTE: When PC applies command to all displays (ID=99), only the #1 set needs to reply by the name of ID=1.

Example 1: Set Brightness as 76 for Display (#02) and this command is valid

Send (Hex Format)

| Name | Length | ID | Command Type | Command | Value1 | Value2 | Value3 | CR |
|------|--------|--------------|--------------|---------|--------|--------|--------|------|
| Hex | 0x38 | 0x30 0x32 | 0x73 | 0x24 | 0x30 | 0x37 | 0x36 | 0x0D |

Reply (Hex Format)

| Name | Length | ID | Command Type | CR |
|------|--------|--------------|--------------|------|
| Hex | 0x34 | 0x30 0x32 | 0x2B | 0x0D |

Example 2: Set Brightness as 75 for Display (#02) and this command is NOT valid

Send (Hex Format)

| Name | Length | ID | Command Type | Command | Value1 | Value2 | Value3 | CR |
|------|--------|--------------|--------------|---------|--------|--------|--------|------|
| Hex | 0x38 | 0x30 0x32 | 0x73 | 0x24 | 0x30 | 0x37 | 0x35 | 0x0D |

Reply (Hex Format)

| Name | Length | ID | Command Type | CR |
|------|--------|--------------|--------------|------|
| Hex | 0x34 | 0x30 0x32 | 0x2D | 0x0D |

Set-Function Table

A. Basic Function

| Set Function | Length | ID | Command | Command | | Value Range | Comments |
|--------------------------------|--------|----|---------|--------------|--------------|--|---|
| | | | | Type (ASCII) | Code (ASCII) | | |
| Power on *3.2.1/ off (standby) | 8 | | s | ! | 21 | 000: STBY 001: ON | 1. The Power-on via LAN control may work only under specific mode. To see display UG for details. *3.1.1 2. "WOL by MAC address" may available as alternative.*3.2.1 |
| Input Select | 8 | | s | " | 22 | 004: HDMI1 014: HDMI2 024: HDMI 006: VGA 007: Slot-in PC (OPS) 009: DP 019: Type-C *3.2.4 00A: Embedded/ Main (Android) | 1. No need for USB 2. For the case of two more same sources, the 2nd digital is used to indicate the extension. 3. The HEX of 00A is 30 30 41. |
| Brightness | 8 | | s | \$ | 24 | 000 ~ 100 900: Bright down (-1) 901: Bright up (+1) *3.1.1 | |
| Backlight *3.2.0 | 8 | | A | B | 42 | 000 ~ 100 | 1. For Android platform whose main mode is controlled by backlight and the other sources are controlled by brightness. 2. Derived from Color calibration. *3.2.0 |
| Power lock | 8 | | s | 4 | 34 | 000: Unlock 001: Lock | *See note in details |
| Volume | 8 | | s | 5 | 35 | 000 ~ 100 900: Volume down(-1) 901:Volume up(+1) | |
| Mute | 8 | | s | 6 | 36 | 000: OFF 001: ON (mute) | |
| Button lock | 8 | | s | 8 | 38 | 000: Unlock 001: Lock | *See note in details |
| Menu lock | 8 | | s | > | 3E | 000: Unlock 001: Lock | *See note in details |

| Set Function | Length | ID | Command | Command | Value Range | Comments | |
|-----------------|--------|----|---------|---------|-------------|--|---|
| Number *3.1.1 | 8 | | s | @ | 40 | 000~009 | |
| Key Pad *3.1.1 | 8 | | s | A | 41 | 000: UP 001: DOWN 002: LEFT 003: RIGHT 004: ENTER 005: INPUT 006: MENU/(EXIT) 007: EXIT | |
| Remote Control | 8 | | s | B | 42 | 000: Disable 001: Enable 002: Pass through | Disable: RCU will be no function Enabled: RCU controls normally Pass through: Display will bypass the RC code to connected device via the RS-232 port, but not react itself. |
| Restore default | 8 | | s | ~ | 7E | 000 | Recover to factory setting |

B. Optional Function

| Set Function | Length | ID | Command | Command | | Value Range (Three ASCII bytes) | Comments |
|----------------------------|--------|----|---------|--------------|----------------------------|--|---|
| | | | | Type (ASCII) | Code (ASCII) Code (Hex) | | |
| Contrast | 8 | | s | # | 23 | 000 ~ 100 | |
| Sharpness | 8 | | s | % | 25 | 000 ~ 100 | |
| Color | 8 | | s | & | 26 | 000 ~ 100 | |
| Tint | 8 | | s | ' | 27 | 000 ~ 100 | |
| Backlight On_Off *3.2.3 | 8 | | s | (| 29 | 000: Off 001: On | |
| Color mode | 8 | | s |) | 29 | 000: Normal 001: Warm 002: Cold 003: Personal | |
| Freeze On_Off *3.2.5 | 8 | | s | * | 2A | 000: Off 001: On | |
| Bass | 8 | | s | . | 2E | 000 ~ 100 | |
| Treble | 8 | | s | / | 2F | 000 ~ 100 | |
| Balance | 8 | | s | 0 | 30 | 000 ~ 100 | 050 is central |
| Picture Size | 8 | | s | 1 | 31 | 000: FULL (16:9) 001: NORMAL (4:3) 002: REAL (1:1) *3.1.0 | |
| OSD language | 8 | | s | 2 | 32 | 000: English 001: French 002: Spanish | Could be extended for more supported languages by model |
| Date: Year | 8 | | s | V | 56 | Y17~Y99 | Last 2 digits (20)17~(20)99 |
| Date: Month | 8 | | s | V | 56 | M01~M12 | 2 digits |
| Date: Day | 8 | | s | V | 56 | D01~D31 | 2 digits |
| Time: Hour | 8 | | s | W | 57 | H00~H23 | 24-hr format. 2 digits. |
| Time: Min | 8 | | s | W | 57 | M00~M59 | 2 digits |
| Time: Sec | 8 | | s | W | 57 | S00~S59 | 2 digits |
| Customized Hot Keys *3.2.6 | 8 | | s | X | 58 | 001~999 001: Open MVBA app *3.2.6 | |

> Appendix

Specifications

| Item | Category | Specifications | | |
|----------------------|-------------------------|---|---------------------------|---------------------------|
| Model | P/N. | IFP6552 - 1C IFP6552-1CN | IFP7552-1C IFP7552-1CN | IFP8652-1C IFP8652-1CN |
| | No. | VS18786 | VS18789 | VS18791 |
| Screen Size | | 65.5" | 74.5" | 85.4" |
| Input Signal | | 4 x HDMI 1 x VGA 1 x USB Type-C 1 x Audio In 2 x LAN (RJ45) 5 x USB Type-A | | |
| Output Signal | | 1 x Audio Out 1 x SPDIF 3 x USB Type-B | | |
| Speaker Output | | 15W x 2, 15W Subwoofer x 1 | | |
| RS-232 | | RS-232 Communication | | |
| Power | Voltage | 100V-240V AC 50/60Hz | | |
| Operating Conditions | Temperature | 32° F to 104° F (0° C to 40° C) | | |
| | Humidity | 10%~90% non-condensing | | |
| | Altitude | < 2,000 m | | |
| Storage Conditions | Temperature | -4° F to 140° F (-20° C to 60° C) | | |
| | Humidity | 10%~90% non-condensing | | |
| | Altitude | < 2,000 m | | |
| Dimensions | Physical W x H x D (mm) | 1488 x 948 x 120 | 1709 x 1071 x 120 | 1957 x 1211 x 120 |
| | Physical W x H x D (in) | 58.6 x 37.3 x 4.7 | 67.3 x 42.2 x 4.7 | 77 x 47.7 x 4.7 |
| Weight | Physical (kg) | 42.35 | 55.25 | 68.65 |
| | Physical (lbs) | 93.37 | 121.81 | 151.35 |
| Power Consumption | On | 170.3W | 233.5W | 286.4W |
| | Off | <0.5W | <0.5W | <0.5W |

NOTE: Product specifications are subject to change without notice.

Display Modes

VGA Mode

| Resolution | Refresh Rate (@) |
|-------------|------------------------|
| 640 x 480 | 60Hz, 72Hz, 75Hz |
| 800 x 600 | 56Hz, 60Hz, 72Hz, 75Hz |
| 1024 x 768 | 60Hz, 70Hz, 75Hz |
| 1152 x 864 | 75Hz |
| 1280 x 720 | 60Hz |
| 1280 x 768 | 60Hz |
| 1280 x 800 | 60Hz |
| 1280 x 960 | 60Hz |
| 1280 x 1024 | 60Hz |
| 1360 x 768 | 60Hz |
| 1366 x 768 | 60Hz |
| 1440 x 900 | 60Hz |
| 1600 x 1200 | 60Hz |
| 1680 x 1050 | 60Hz |
| 1920 x 1080 | 60Hz |

HDMI Mode

| Resolution | Refresh Rate (@) |
|-------------|-------------------------|
| 640 x 480 | 60Hz |
| 800 x 600 | 60Hz |
| 1024 x 768 | 60Hz |
| 1280 x 960 | 60Hz |
| 1920 x 1080 | 60Hz |
| 3840 x 2160 | 24Hz, 30Hz, 50Hz, 60Hz |
| 480i | 60Hz |
| 480p | 59Hz, 60Hz |
| 576i | 50Hz |
| 576p | 50Hz |
| 720p | 50Hz, 60Hz |
| 1080i | 50Hz, 60Hz |
| 1080p | 24Hz, 30 Hz, 50Hz, 60Hz |

Type-C Mode

| Resolution | Refresh Rate (@) |
|-------------|-------------------------|
| 640 x 480 | 60Hz, 75Hz |
| 800 x 600 | 60Hz, 75Hz |
| 1024 x 768 | 60Hz, 75Hz |
| 1280 x 800 | 60Hz |
| 1280 x 960 | 60Hz |
| 1280 x 1024 | 60Hz |
| 1440 x 900 | 60Hz |
| 1920 x 1080 | 60Hz |
| 3840 x 2160 | 24Hz, 30Hz, 60Hz |
| 480p | 59Hz, 60Hz |
| 720p | 60Hz |
| 1080p | 24Hz, 30 Hz, 50Hz, 60Hz |

Troubleshooting

This section describes some common problems that you may experience when using the ViewBoard.

| Problem or Issue | Possible Solutions |
|---------------------------------|--|
| Remote Control is not working | <ol style="list-style-type: none">1. Check whether something is obstructing the display's remote control receiver.2. Check whether the batteries in the remote control are installed correctly.3. Check whether the batteries need to be replaced. |
| The unit turns off unexpectedly | <ol style="list-style-type: none">1. Check whether Sleep mode is enabled.2. Check if there is a power outage in your area.3. Turn on the display and see if the problem is with the signal and control system. |

PC Mode

| Problem or Issue | Possible Solutions |
|----------------------|--|
| No PC signal | <ol style="list-style-type: none">1. Check the display settings.2. Check the display resolution.3. Adjust the Hs & Vs (synchronization) settings using the OSD menu. |
| Background streaking | <ol style="list-style-type: none">1. Choose auto adjust.2. Adjust clock and phase. |
| False color | <ol style="list-style-type: none">1. Check the VGA connection.2. Adjust the chroma, brightness, and contrast settings. |
| Unsupported format | <ol style="list-style-type: none">1. Choose auto adjust.2. Adjust clock and phase settings. |

Touch Function

| Problem or Issue | Possible Solutions |
|------------------------------|---|
| Touch function does not work | <ol style="list-style-type: none">1. Check that drivers are installed correctly.2. Reinstall driver(s).3. Check setup and align it.4. Check whether the touch pen is working properly. |

Video Not Working Properly

| Problem or Issue | Possible Solutions |
|---------------------------------------|---|
| No picture/ No sound | <ol style="list-style-type: none">1. Check the Power status.2. Check the signal cable.3. Check that the internal PC is installed correctly. |
| Picture is unclear or cuts in and out | <ol style="list-style-type: none">1. Check the signal cable.2. Check if other electronics are interrupting the signal. |
| Poor picture | <ol style="list-style-type: none">1. Adjust chroma, brightness, and contrast settings in the menu.2. Check the signal cable. |

Audio Not Working Properly

| Problem or Issue | Possible Solutions |
|------------------|--|
| No sound | <ol style="list-style-type: none">1. Press the Mute/Unmute button.2. Adjust the volume.3. Check the audio cable. |
| One speaker only | <ol style="list-style-type: none">1. Adjust the sound balance in the menu.2. Check the sound control panel settings of the computer.3. Check the audio cable. <p>NOTE: SPDIF and Earphone only work in ViewBoard Player, HDMI, Type-C, and DisplayPort (DP) channels.</p> |

Maintenance

General Precautions

- Make sure the device is turned off and the power cable is unplugged from the power outlet.
- Never spray or pour any liquid directly onto the screen or case.
- Handle the device with care, as a darker-colored device, if scuffed, may show marks more clearly than a lighter-colored device.
- Do not use the system continuously for long periods of time.

Cleaning the Screen

- Wipe the screen with a clean, soft, lint-free cloth. This removes dust and other particles.
- If the screen is still not clean, apply a small amount of non-ammonia, non-alcohol based glass cleaner onto a clean, soft, lint-free cloth; then wipe the screen.

Cleaning the Case

- Use a soft, dry cloth.
- If the case is still not clean, apply a small amount of non-ammonia, non-alcohol based, mild non-abrasive detergent onto a clean, soft, lint-free cloth, then wipe the surface.

Disclaimer

- ViewSonic® does not recommend the use of any ammonia or alcohol-based cleaners on the display screen or case. Some chemical cleaners have been reported to damage the screen and/or case of the device.
- ViewSonic® will not be liable for damage resulting from use of any ammonia or alcohol-based cleaners.

NOTE: If condensation appears between the glass and the panel, keep the display turned on until the moisture disappears.

> Regulatory and Service Information

Compliance Information

This section addresses all connected requirements and statements regarding regulations. Confirmed corresponding applications shall refer to nameplate labels and relevant markings on the unit.

FCC Compliance Statement

This device has been tested and found to comply with the limits for a Class A digital device, pursuant to Part 15 of the FCC Rules. These limits are designed to provide reasonable protection against harmful interference when the equipment is operated in a commercial environment. This equipment generates, uses, and can radiate radio frequency energy and, if not installed and used in accordance with the instruction manual, may cause harmful interference to radio communications. Operation of this equipment in a residential area is likely to cause harmful interference, in which case the user will be required to correct the interference at his own expense.

Properly shielded and grounded cables and connectors must be used in order to meet FCC emission limits. ViewSonic is not responsible for any radio or television interference caused by using other than recommended cables and connectors or by unauthorized changes or modifications to this equipment. Unauthorized changes or modifications could void the user's authority to operate the equipment.

This device complies with Part 15 of the FCC Rules. Operation is subject to the following two conditions:

- (1) this device may not cause harmful interference, and
- (2) this device must accept any interference received, including interference that might cause undesired operation.

Class A:

NOTE: This device has been tested and found to comply with the limits for a Class A digital device, pursuant to part 15 of the FCC Rules. These limits are designed to provide reasonable protection against harmful interference when the equipment is operated in a commercial environment. This equipment generates, uses, and can radiate radio frequency energy and, if not installed and used in accordance with the instruction manual, may cause harmful interference to radio communications. Operation of this equipment in a residential area is likely to cause harmful interference in which case the user will be required to correct the interference at his own expense.

Warning: You are cautioned that changes or modifications not expressly approved by the party responsible for compliance could void your authority to operate the equipment.

Industry Canada Statement

CAN ICES-003 (A)/NMB-003(A)

CE Conformity for European Countries



The device complies with the EMC Directive 2014/30/EU and Low Voltage Directive 2014/35/EC.

The following information is only for EU-member states:

The mark shown to the right is in compliance with the Waste Electrical and Electronic Equipment Directive 2012/19/EU (WEEE). The mark indicates the requirement NOT to dispose the equipment as unsorted municipal waste, but use the return and collection systems according to local law.



Attention: This is a Class A product. In a domestic environment this product may cause radio interference in which case the user may be required to take adequate measures.

Declaration of RoHS2 Compliance

This product has been designed and manufactured in compliance with Directive 2011/65/EU of the European Parliament and the Council on restriction of the use of certain hazardous substances in electrical and electronic equipment (RoHS2 Directive) and is deemed to comply with the maximum concentration values issued by the European Technical Adaptation Committee (TAC) as shown below:

| Substance | Proposed Maximum Concentration | Actual Concentration |
|---|--------------------------------|----------------------|
| Lead (Pb) | 0.1% | < 0.1% |
| Mercury (Hg) | 0.1% | < 0.1% |
| Cadmium (Cd) | 0.01% | < 0.01% |
| Hexavalent Chromium (Cr6 ⁺) | 0.1% | < 0.1% |
| Polybrominated biphenyls (PBB) | 0.1% | < 0.1% |
| Polybrominated diphenyl ethers (PBDE) | 0.1% | < 0.1% |
| Bis (2-ethylhexyl) phthalate (DEHP) | 0.1% | < 0.1% |
| Butyl benzyl phthalate (BBP) | 0.1% | < 0.1% |
| Dibutyl phthalate (DBP) | 0.1% | < 0.1% |
| Diisobutyl phthalate (DIBP) | 0.1% | < 0.1% |

Certain components of products as stated above are exempted under the Annex III of the RoHS2 Directives as noted below:

- Lead as an alloying element in aluminium containing up to 0.4% lead by weight.
- Copper alloy containing up to 4% lead by weight.
- Lead in high melting temperature type solders (i.e., lead-based alloys containing 85% by weight or more lead).
- Electrical and electronic components containing lead in a glass or ceramic other than dielectric ceramic in capacitors, (e.g., piezoelectronic devices, or in a glass or ceramic matrix compound).

ENERGY STAR® statement

ENERGY STAR® is a U.S. Environmental Protection Agency voluntary program that helps businesses and individuals save money and protect our climate through superior energy efficiency. Products that earn the ENERGY STAR® prevent greenhouse gas emissions by meeting strict energy efficiency criteria or requirements set by the U.S. Environmental Protection Agency.

As an ENERGY STAR® Partner, ViewSonic is determined to meet the ENERGY STAR® Guidelines and mark all certified models with the ENERGY STAR® logo.

The following logo appears on all ENERGY STAR®-certified models:



NOTE: The power management features significantly reduce energy consumption when the product is not in use. Power management allows the device to automatically enter a low power “sleep” mode after a defined period of inactivity. And the power management features also enter Sleep Mode or Off Mode within 5 minutes of being disconnected from a host computer. Please note any change in energy settings will increase energy consumption.

Indian Restriction of Hazardous Substances

Restriction on Hazardous Substances statement (India). This product complies with the “India E-waste Rule 2011” and prohibits use of lead, mercury, hexavalent chromium, polybrominated biphenyls or polybrominated diphenyl ethers in concentrations exceeding 0.1 weight % and 0.01 weight % for cadmium, except for the exemptions set in Schedule 2 of the Rule.

Product Disposal at End of Product Life

ViewSonic® respects the environment and is committed to working and living green. Thank you for being part of Smarter, Greener Computing. Please visit the ViewSonic® website to learn more.

USA & Canada:

<http://www.viewsonic.com/company/green/recycle-program/>

Europe:

<http://www.viewsoniceurope.com/eu/support/call-desk/>

Taiwan:

<https://recycle.epa.gov.tw/>

Copyright Information

Copyright© ViewSonic® Corporation, 2021. All rights reserved.

Macintosh and Power Macintosh are registered trademarks of Apple Inc.

Microsoft, Windows, and the Windows logo are registered trademarks of Microsoft Corporation in the United States and other countries.

ViewSonic®, the three birds logo, OnView, ViewMatch, and ViewMeter are registered trademarks of ViewSonic® Corporation.

VESA is a registered trademark of the Video Electronics Standards Association. DPMS, DisplayPort, and DDC are trademarks of VESA.

Disclaimer: ViewSonic® Corporation shall not be liable for technical or editorial errors or omissions contained herein; nor for incidental or consequential damages resulting from furnishing this material, or the performance or use of this product.

In the interest of continuing product improvement, ViewSonic® Corporation reserves the right to change product specifications without notice. Information in this document may change without notice.

No part of this document may be copied, reproduced, or transmitted by any means, for any purpose without prior written permission from ViewSonic® Corporation.

Customer Service

For technical support or product service, see the table below or contact your reseller.

NOTE: You will need the product's serial number.

| Country/ Region | Website | Country/ Region | Website |
|----------------------------------|--|--------------------------|--|
| Asia Pacific & Africa | | | |
| Australia | www.viewsonic.com/au/ | Bangladesh | www.viewsonic.com/bd/ |
| 中国 (China) | www.viewsonic.com.cn | 香港 (繁體中文) | www.viewsonic.com/hk/ |
| Hong Kong (English) | www.viewsonic.com/hk-en/ | India | www.viewsonic.com/in/ |
| Indonesia | www.viewsonic.com/id/ | Israel | www.viewsonic.com/il/ |
| 日本 (Japan) | www.viewsonic.com/jp/ | Korea | www.viewsonic.com/kr/ |
| Malaysia | www.viewsonic.com/my/ | Middle East | www.viewsonic.com/me/ |
| Myanmar | www.viewsonic.com/mm/ | Nepal | www.viewsonic.com/np/ |
| New Zealand | www.viewsonic.com/nz/ | Pakistan | www.viewsonic.com/pk/ |
| Philippines | www.viewsonic.com/ph/ | Singapore | www.viewsonic.com/sg/ |
| 臺灣 (Taiwan) | www.viewsonic.com/tw/ | ประเทศไทย | www.viewsonic.com/th/ |
| Việt Nam | www.viewsonic.com/vn/ | South Africa & Mauritius | www.viewsonic.com/za/ |
| Americas | | | |
| United States | www.viewsonic.com/us | Canada | www.viewsonic.com/us |
| Latin America | www.viewsonic.com/la | | |
| Europe | | | |
| Europe | www.viewsonic.com/eu/ | France | www.viewsonic.com/fr/ |
| Deutschland | www.viewsonic.com/de/ | Қазақстан | www.viewsonic.com/kz/ |
| Россия | www.viewsonic.com/ru/ | España | www.viewsonic.com/es/ |
| Türkiye | www.viewsonic.com/tr/ | Україна | www.viewsonic.com/ua/ |
| United Kingdom | www.viewsonic.com/uk/ | | |

Limited Warranty

ViewSonic® Smart White Board

What the warranty covers:

ViewSonic® warrants its products to be free from defects in material and workmanship during the warranty period. If a product proves to be defective in material or workmanship during the warranty period, ViewSonic® will, at its sole option, and as your sole remedy, repair or replace the product with a similar product. Replacement Product or parts may include remanufactured or refurbished parts or components. The repair or replacement unit or parts or components will be covered by the balance of the time remaining on the customer's original limited warranty and the warranty period will not be extended. ViewSonic® provides no warranty for any third-party software whether included with the product or installed by the customer, installation of any unauthorized hardware parts or components (e.g. Projector Lamps). (Please refer to: "What the warranty excludes and does not cover" section).

Who the warranty protects:

This warranty is valid only for the first consumer purchaser.

What the warranty excludes and does not cover:

- Any product on which the serial number has been defaced, modified, or removed.
- Damage, deterioration, or malfunction resulting from:
 - » Accident, misuse, neglect, fire, water, lightning, or other acts of nature, unauthorized product modification, or failure to follow instructions supplied with the product.
 - » Repair or attempted repair by anyone not authorized by ViewSonic®.
 - » Damage to or loss of any programs, data, or removable storage media.
 - » Normal wear and tear.
 - » Removal or installation of the product.
- Software or data loss occurring during repair or replacement.
- Any damage of the product due to shipment.
- Causes external to the product, such as electric power fluctuations or failure.
- Use of supplies or parts not meeting ViewSonic's specifications.
- Failure of owner to perform periodic product maintenance as stated in the User Guide.
- Any other cause which does not relate to a product defect.

- Damage caused by static (non-moving) images displayed for lengthy periods of time (also referred to as image burn-in).
- Software - Any third-party software included with the product or installed by the customer.
- Hardware/Accessories/Parts/Components – Installation of any unauthorized hardware, accessories, consumable parts or components (e.g. Projector Lamps).
- Damage to, or abuse of, the coating on the surface of the display through inappropriate cleaning as described in the product User Guide.
- Removal, installation, and set-up service charges, including wall-mounting of the product.

How to get service:

- For information about receiving service under warranty, contact ViewSonic® Customer Support (Please refer to the “Customer Service” page). You will need to provide your product’s serial number.
- To obtain warranty service, you will be required to provide: (a) the original dated sales slip, (b) your name, (c) your address, (d) a description of the problem, and (e) the serial number of the product.
- Take or ship the product, freight prepaid, in the original container to an authorized ViewSonic® service center or ViewSonic®.
- For additional information or the name of the nearest ViewSonic® service center, contact ViewSonic®.

Limitation of implied warranties:

There are no warranties, express or implied, which extend beyond the description contained herein including the implied warranty of merchantability and fitness for a particular purpose.

Exclusion of damages:

ViewSonic's liability is limited to the cost of repair or replacement of the product. ViewSonic® shall not be liable for:

- Damage to other property caused by any defects in the product, damages based upon inconvenience, loss of use of the product, loss of time, loss of profits, loss of business opportunity, loss of goodwill, interference with business relationships, or other commercial loss, even if advised of the possibility of such damages.
- Any other damages, whether incidental, consequential or otherwise.
- Any claim against the customer by any other party.
- Repair or attempted repair by anyone not authorized by ViewSonic®.

Effect of state law:

This warranty gives you specific legal rights, and you may also have other rights which vary from state to state. Some states do not allow limitations on implied warranties and/or do not allow the exclusion of incidental or consequential damages, so the above limitations and exclusions may not apply to you.

Sales outside the U.S.A. and Canada:

For warranty information and service on ViewSonic® products sold outside of the U.S.A. and Canada, contact ViewSonic® or your local ViewSonic® dealer.

The warranty period for this product in mainland China (Hong Kong, Macao, and Taiwan Excluded) is subject to the terms and conditions of the Maintenance Guarantee Card.

For users in Europe and Russia, full details of warranty provided can be found at: <http://www.viewsonic.com/eu/> under "Support/Warranty Information".

Mexico Limited Warranty

ViewSonic® Smart White Board

What the warranty covers:

ViewSonic® warrants its products to be free from defects in material and workmanship, under normal use, during the warranty period. If a product proves to be defective in material or workmanship during the warranty period, ViewSonic® will, at its sole option, repair or replace the product with a like product. Replacement product or parts may include remanufactured or refurbished parts or components & accessories.

Who the warranty protects:

This warranty is valid only for the first consumer purchaser.

What the warranty excludes and does not cover:

- Any product on which the serial number has been defaced, modified or removed.
- Damage, deterioration, or malfunction resulting from:
 - » Accident, misuse, neglect, fire, water, lightning, or other acts of nature, unauthorized product modification, unauthorized attempted repair, or failure to follow instructions supplied with the product.
 - » Causes external to the product, such as electrical power fluctuations or failure.
 - » Use of supplies or parts not meeting ViewSonic®'s specifications.
 - » Normal wear and tear.
 - » Any other cause which does not relate to a product defect.
- Any product exhibiting a condition commonly known as “image burn-in” which results when a static image is displayed on the product for an extended period of time.
- Removal, installation, insurance, and set-up service charges.

How to get service:

For information about receiving service under warranty, contact ViewSonic® Customer Support (Please refer to the attached “Customer Service” page). You will need to provide your product’s serial number, so please record the product information in the space provided below on your purchase for your future use. Please retain your receipt of proof of purchase to support your warranty claim.

For Your Records

Product Name: _____ Model Number: _____
Document Number: _____ Serial Number: _____
Purchase Date: _____ Extended Warranty Purchase? _____(Y/N)
If so, what date does warranty expire? _____

- To obtain warranty service, you will be required to provide (a) the original dated sales slip, (b) your name, (c) your address, (d) a description of the problem, and (e) the serial number of the product.
- Take or ship the product, in the original container packaging, to an authorized ViewSonic® service center.
- Round trip transportation costs for in-warranty products will be paid by ViewSonic®.

Limitation of implied warranties:

There are no warranties, express or implied, which extend beyond the description contained herein including the implied warranty of merchantability and fitness for a particular purpose.

Exclusion of damages:

ViewSonic®’s liability is limited to the cost of repair or replacement of the product. ViewSonic® shall not be liable for:

- Damage to other property caused by any defects in the product, damages based upon inconvenience, loss of use of the product, loss of time, loss of profits, loss of business opportunity, loss of goodwill, interference with business relationships, or other commercial loss, even if advised of the possibility of such damages.
- Any other damages, whether incidental, consequential or otherwise.
- Any claim against the customer by any other party.
- Repair or attempted repair by anyone not authorized by ViewSonic®.

| | |
|---|---|
| Contact Information for Sales & Authorized Service (Centro Autorizado de Servicio) within Mexico: | |
| Name, address, of manufacturer and importers: México, Av. de la Palma #8 Piso 2 Despacho 203, Corporativo Interpalmas, Col. San Fernando Huixquilucan, Estado de México Tel: (55) 3605-1099 http://www.viewsonic.com/la/soporte/index.htm | |
| NÚMERO GRATIS DE ASISTENCIA TÉCNICA PARA TODO MÉXICO: 001.866.823.2004 | |
| Hermosillo: Distribuciones y Servicios Computacionales SA de CV. Calle Juarez 284 local 2 Col. Bugambilias C.P: 83140 Tel: 01-66-22-14-9005 E-Mail: disc2@hmo.megared.net.mx | Villahermosa: Compumantenimientos Garantizados, S.A. de C.V. AV. GREGORIO MENDEZ #1504 COL, FLORIDA C.P. 86040 Tel: 01 (993) 3 52 00 47 / 3522074 / 3 52 20 09 E-Mail: compumantenimientos@prodigy.net.mx |
| Puebla, Pue. (Matriz): RENTA Y DATOS, S.A. DE C.V. Domicilio: 29 SUR 721 COL. LA PAZ 72160 PUEBLA, PUE. Tel: 01(52).222.891.55.77 CON 10 LINEAS E-Mail: datos@puebla.megared.net.mx | Veracruz, Ver.: CONEXION Y DESARROLLO, S.A DE C.V. Av. Americas # 419 ENTRE PINZÓN Y ALVARADO Fracc. Reforma C.P. 91919 Tel: 01-22-91-00-31-67 E-Mail: gacosta@qplus.com.mx |
| Chihuahua: Soluciones Globales en Computación C. Magisterio # 3321 Col. Magisterial Chihuahua, Chih. Tel: 4136954 E-Mail: Cefeo@soluglobales.com | Cuernavaca: Compusupport de Cuernavaca SA de CV Francisco Leyva # 178 Col. Miguel Hidalgo C.P. 62040, Cuernavaca Morelos Tel: 01 777 3180579 / 01 777 3124014 E-Mail: aquevedo@compusupportcva.com |
| Distrito Federal: QPLUS, S.A. de C.V. Av. Coyoacán 931 Col. Del Valle 03100, México, D.F. Tel: 01(52)55-50-00-27-35 E-Mail : gacosta@qplus.com.mx | Guadalajara, Jal.: SERVICRECE, S.A. de C.V. Av. Niños Héroes # 2281 Col. Arcos Sur, Sector Juárez 44170, Guadalajara, Jalisco Tel: 01(52)33-36-15-15-43 E-Mail: mmiranda@servicrece.com |
| Guerrero Acapulco: GS Computación (Grupo Sesicomp) Progreso #6-A, Colo Centro 39300 Acapulco, Guerrero Tel: 744-48-32627 | Monterrey: Global Product Services Mar Caribe # 1987, Esquina con Golfo Pérsico Fracc. Bernardo Reyes, CP 64280 Monterrey N.L. México Tel: 8129-5103 E-Mail: aydeem@gps1.com.mx |
| MERIDA: ELECTROSER Av Reforma No. 403Gx39 y 41 Mérida, Yucatán, México CP97000 Tel: (52) 999-925-1916 E-Mail: rrrb@sureste.com | Oaxaca, Oax.: CENTRO DE DISTRIBUCION Y SERVICIO, S.A. de C.V. Murguía # 708 P.A., Col. Centro, 68000, Oaxaca Tel: 01(52)95-15-15-22-22 Fax: 01(52)95-15-13-67-00 E-Mail: gpotai2001@hotmail.com |
| Tijuana: STD Av Ferrocarril Sonora #3780 L-C Col 20 de Noviembr Tijuana, Mexico | FOR USA SUPPORT: ViewSonic® Corporation 381 Brea Canyon Road, Walnut, CA. 91789 USA Tel: 800-688-6688 E-Mail: http://www.viewsonic.com |



ViewSonic®