

1RK-MOD ONERack module

Installation Guide V1.30

In this guide

In the box	1
Mounting devices on ONERack modules	3
Tips for mounting your devices	4
Powering ONERack modules	5
Fitting ONERack modules	6
Fitting the guide rails and dock	7
Connecting cables	9
Connecting your devices to the internal power supply ..10	
Connecting your devices to pass-through power	15
Connecting your devices to external power	20
Safety	21
Contact us	22

In the box

1x ONErack module, including voltage selector:

Either with lower tab,

or with upper and lower tabs

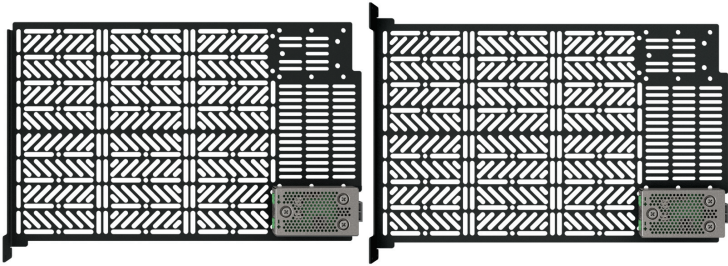

1x daisy-chain cable



2x guide rails



1x rear dock:

Either without bracket,

or with bracket

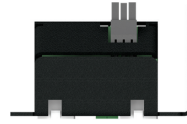
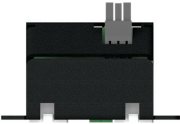

3x power connectors



6x M3 screws (**Note:** if your module has only the lower tab, you only need 4 screws)



1x label sheet



1 x A3 template



In the unlikely event that a component is missing or damaged, please contact tech.usa@tvone.com or tech.europe@tvone.com.

Tools

Pozidriv® PZ1 crosshead screwdriver

2 mm flat head screwdriver

Wire cutters

Wire strippers

Voltmeter

Optional:

Self-adhesive hook and loop

Scissors

Cable ties

Third-party mounting hardware

Mounting devices on ONErack modules

The innovative ONErack module enables you to efficiently mount multiple devices. The module provides adjustable voltage and supports many ways to mount devices and secure cables. When you add a second voltage selector, you can provide two voltage options to devices mounted on the module.

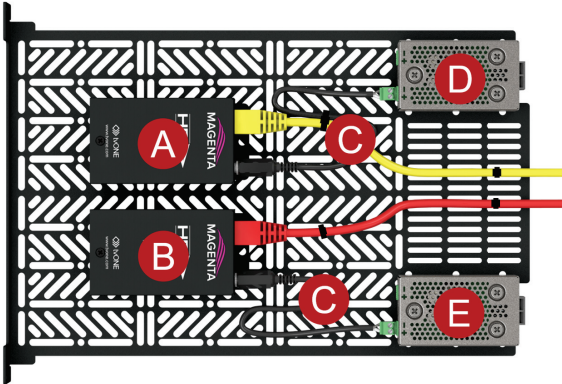

- A** Secured with screws
- B** Secured with self-adhesive hook and loop
- C** Secured with cable ties
- D** Optional second voltage selector
- E** Voltage selector

Tips for mounting your devices

When you choose how to place your devices:

- Allow enough cable to be able to access any sources, for example, Ethernet or external power.
- Allow enough cable to pull the module forward so you can access your devices. If your cables are short, consider mounting the device further back on the module.
- Allow enough room around each device for ventilation.
- Allow enough room to reach the buttons of your devices.

Powering ONErack modules

ONErack modules are designed to work with the ONErack internal power supply, but there are other options – you could use pass-through power or an external power supply.

Voltage selectors

- Each voltage selector provides the same voltage to both connectors.
- Each voltage selector provides either your choice of voltage with the internal power supply, or the voltage of your external power supply when you choose pass-through power.
- If you want to provide more than one voltage to devices mounted on a ONErack module, or if you want to provide both internal power and pass-through power, you must connect a second voltage selector, sold separately.

Ask your sales representative about 1RK-XTRA-PWR.

ONErack internal power supply

The internal power supply works with the voltage selector to give you seven DC voltage options:

- 5 V @ 7 A
- 7.5 V @ 4.7 A
- 9 V @ 3.9 A
- 12 V @ 2.9 A
- 13.5 V @ 2.6 A
- 18 V @ 1.9 A
- 24 V @ 1.5 A

ONErack pass-through power

If the voltage your device needs is not available from the voltage selector, then you can connect your device's power supply through the dock. Depending on the capabilities of your power supply, you might be able to supply power to multiple devices, but at a fixed voltage. You can use a power supply up to 24 V @ 1.5 A.

External power supply

If you don't want to cut your power lead, you can bypass the dock and connect your power supply directly to your device. With this method you can only provide power to a single device.

Fitting ONErack modules

This guide assumes you have already built a ONErack chassis and fitted an internal power supply, or chosen an alternative method for powering your devices.

Read more about powering ONErack modules on page 5.

See the installation guides for the chassis and internal power supply.

Overview of fitting ONErack modules

1. Mount one or more devices on your ONErack module.



We recommend that you mount at least your tallest device.

Read more on page 7.

2. Fit the guide rails and insert the module.

Read more on page 7.

3. Fit the dock and secure it with two M3 screws. Use the module as a guide to align the dock.

Read more on page 7.

4. Optional: fit all your remaining modules.

5. Mount any remaining devices, select a voltage, then connect and secure your device cables.

Read more on page 9.

6. Insert the module and power on the ONErack system.

Fitting the guide rails and dock

! To avoid damaging your ONERack, build it in a clean, tidy area.

Before you fit the guide rails and dock, mount at least your tallest device on the ONERack module. This helps you to determine the positions of the modules. If you intend to fit several modules at once, fit each one with the tallest device for that module.

Read about mounting devices on ONERack modules on page 3.

1. Clip the guide rails into the lower and upper mounting rails.

Use the numbers to help you fit the guide rails straight and in line with one another. You can also use the template included in the box.

Make sure the groove is on the right when you look from the front of the chassis.

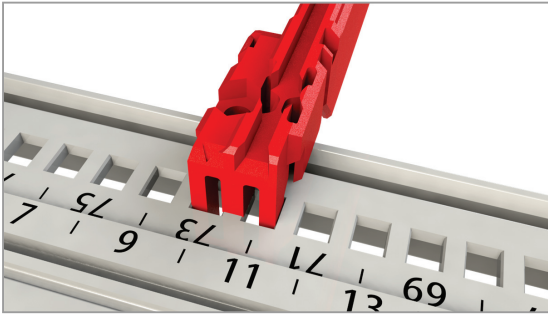

- Slide the module into the groove in the guide rails.

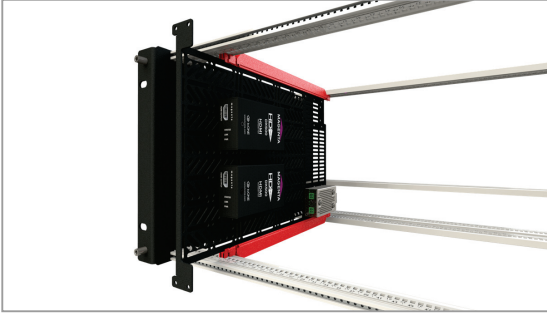

- Screw the module in place temporarily with one or two M3 screws.
- At the rear of the chassis, push the dock into the voltage selector.

If you have a dock with a bracket, use the slot in the bracket to help you align the dock. If you have a dock without a bracket, push the connector on the dock into the connector on the voltage selector.



- Screw the dock in place with two M3 screws.

Connecting cables

You can connect your devices to the internal power supply, to pass-through power, or to their own external power supplies.

Read more about powering ONErack modules on page 5.

Read about connecting devices to the internal power supply on page 10.

Read about connecting devices to pass-through power on page 15.

Read about connecting your devices to external power on page 20.

Connecting your devices to the internal power supply



Risk of damage to equipment

- Make sure you set the voltage selector to the correct value for your device or devices.
- Do not connect two devices that need different voltages to the same voltage selector.
- If you have devices that need different voltages, fit a second voltage selector or use a second ONERack module.
- Do not rotate the voltage selector switch when the ONERack system is powered.
- Before you cut any power leads, record the polarity and voltage for each one with a suitable meter.
- Before you connect any rewired DC power connector to any device, check that the polarity and voltage match what you recorded before you cut the power lead.
- Remove your device's power lead from the mains supply before you cut the cable.
- Cutting power leads should only be done by competent, qualified personnel – if in doubt, consult a qualified electrician.
- The internal power supply can supply up to 200 W to a single daisy-chain, or up to 250 W across two daisy-chains. Do not overload the internal power supply. If the internal power supply is overloaded, it will not start.
- Each module can supply up to 35 W. Do not overload the modules.
- If you mount a heater on a module, place it as far as possible away from the voltage selector. Allow enough space around the heater for cooling.

1. Remove the screws holding the ONERack module in place and remove the module.



2. Finish mounting your devices on the ONERack module.
3. Undo the screws on top of the voltage selector and remove the cover.

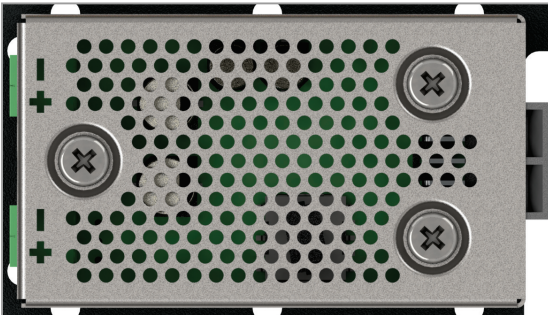

4. Turn the switch inside the voltage selector until the white dot points to the right voltage for your devices.

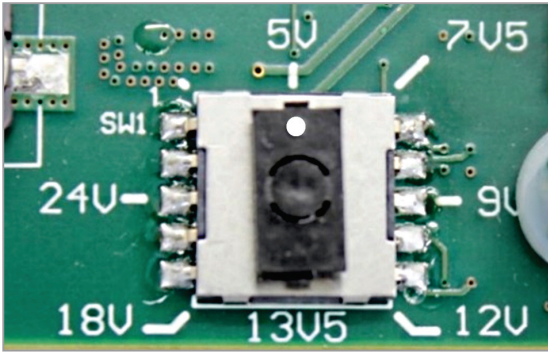

5. Replace the cover of the voltage selector and screw in place.
6. Cut the power lead for your device.
Make sure you leave enough length to reach the voltage selector.



7. Strip the insulation from the ends of the wires and identify which is positive and which is negative.
8. Insert the stripped ends into the power connector. Make sure that the polarity is correct, as shown, before you tighten the screws.



9. Insert the power connector into the voltage selector.

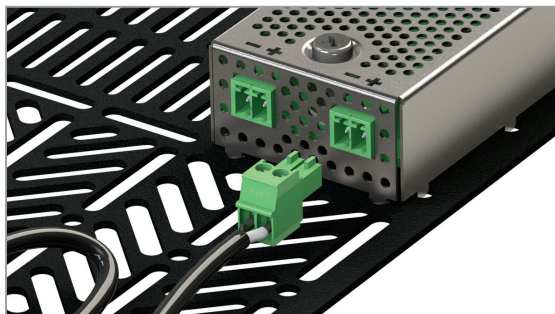

10. Use a long daisy-chain cable to connect the internal power supply to the module.

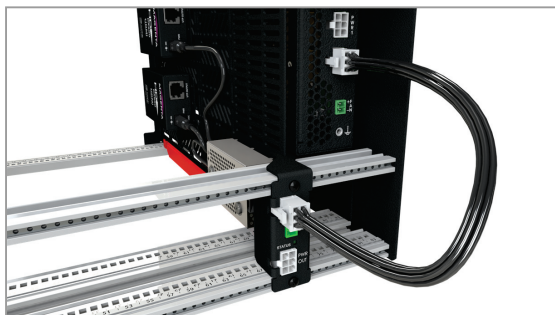

When you connect further modules, use the shorter daisy-chain cables to connect the output of the last dock to the input of the next dock.

11. Check that all your devices are connected with the correct voltages.

12. Connect your ONERack module to the dock and screw it in place. If you have both upper and lower tabs, use four screws. If you have the lower tab only, use two screws.

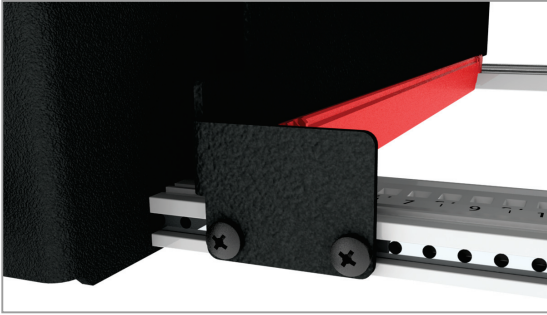

13. Connect the internal power supply to an AC power outlet and check that your devices work correctly.

Connecting your devices to pass-through power



Risk of damage to equipment

- Before you cut any power leads, record the polarity and voltage for each one with a suitable meter.
- Before you connect any rewired DC power connector to any device, check that the polarity and voltage match what you recorded before you cut the power lead.
- Remove your device's power lead from the mains supply before you cut the cable.
- Cutting power leads should only be done by competent, qualified personnel – if in doubt, consult a qualified electrician.
- Each module can supply up to 35 W. Do not overload the modules.

1. Remove the screws holding the ONERack module in place and remove the module.

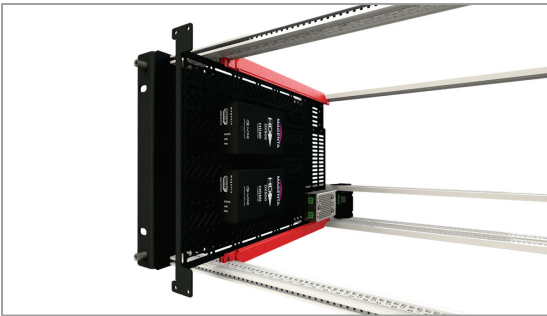

2. Finish mounting your devices on the ONERack module.

3. Undo the screws on top of the voltage selector and remove the cover.

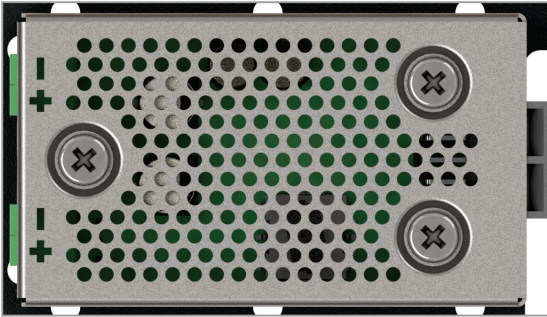

4. Move the jumper from INT POWER to EXT POWER.

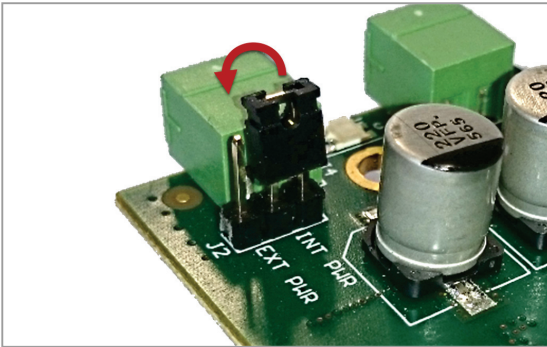

Any power connected to the voltage selector now bypasses the voltage selector switch.

5. Replace the cover of the voltage selector and screw in place.
6. Cut the power lead for your device.
Make sure you leave enough length to reach the voltage selector.



7. Strip the insulation from the ends of the wires and identify which is positive and which is negative.

8. Insert the stripped ends into the power connector. Make sure that the polarity is correct, as shown, before you tighten the screws.



9. Insert the power connector into the voltage selector.

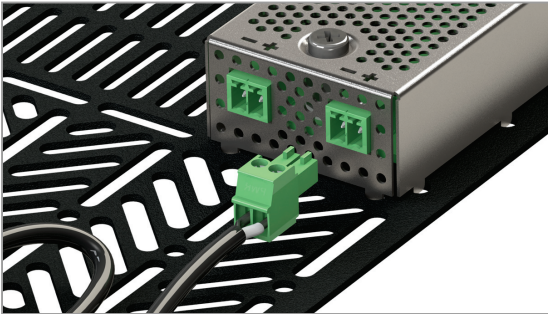

10. Repeat steps 6 to 8 for the other piece of the power lead.



11. Insert the power connector into the dock.

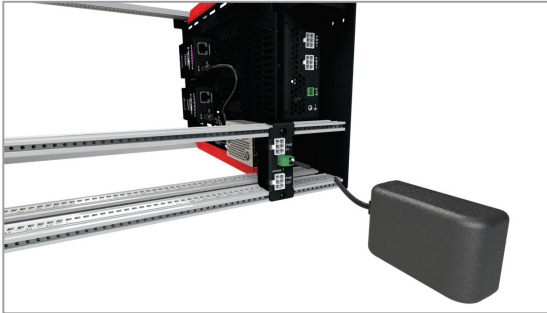

12. Plug the power lead into the mains supply.

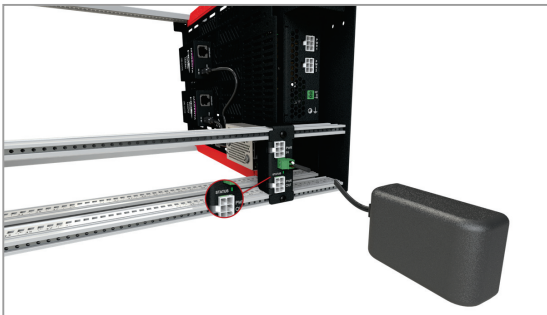

- If the STATUS LED is green, the polarity is correct. Go to the next step.
- If the STATUS LED is red, the polarity is not correct. Repeat step 10.
- If the STATUS LED is orange, the power lead is for AC power and is not supported by the ONERack system. Use the external power method.

Read about the external power method on page 20.

13. Connect your ONErack module to the dock and screw it in place. If you have both upper and lower tabs, use four screws. If you have the lower tab only, use two screws.

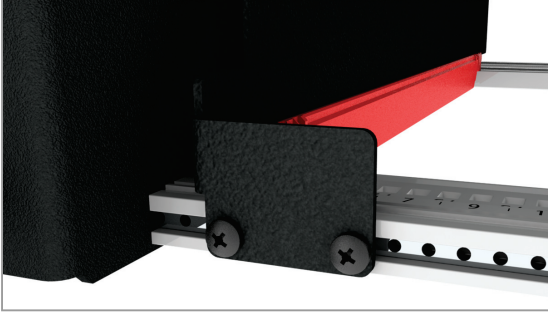

Connecting your devices to external power

You can connect any of your devices using its own power supply.

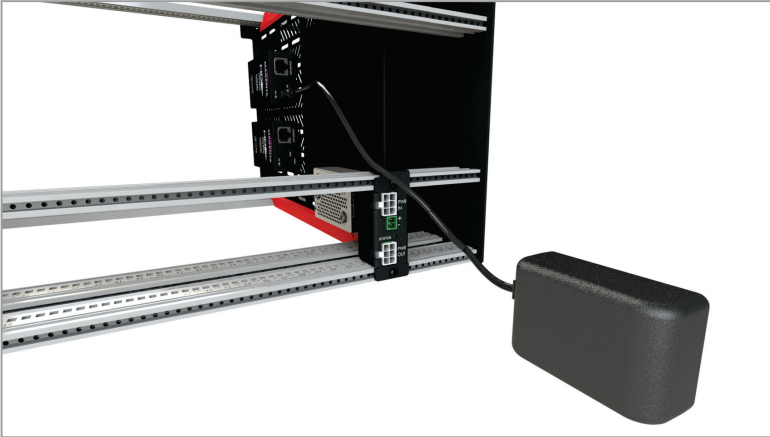

Safety



Risk of damage in transit

Your ONErack and devices can be damaged in transit.

- Do not ship the ONErack system with modules fitted.
- Package modules separately.
- You can ship modules with mounted devices.



Risk of damage to equipment

- Make sure you set the voltage selector to the correct value for your device or devices.
- If you have devices that need different voltages, fit a second voltage selector or use a second ONErack module.
- Do not rotate the voltage selector switch when the ONErack system is powered.
- Record the polarity and voltage for each device's DC power lead with a suitable meter.
- Remove each device's power lead from the mains supply before you cut the cable.
- Cutting power leads should only be done by competent, qualified personnel – if in doubt, consult a qualified electrician.
- Each daisy-chain cable is protected by an 8 A fuse. Do not overload the cables.
- The internal power supply can supply up to 200 W to a single daisy-chain, or up to 250 W across two daisy-chains. Do not overload the internal power supply. If the internal power supply is overloaded, it will not start.
- Each module can supply up to 35 W. Do not overload the modules.

Contact us

 tvone.com

 info@tvone.com

 **Support NCSA:** tech.usa@tvone.com

 **Support EMEA:** tech.europe@tvone.com

 **Support Asia:** tech.asia@tvone.com

Information in this document is subject to change without notice. No part of this publication may be reproduced, stored in a retrieval system, or transmitted in any form or any means electronic or mechanical, including photocopying and recording for any purpose other than the purchaser's personal use without the written permission of tvONE.

Copyright © 2019 tvONE™. All rights reserved.

Registered in the U.S. Patent and Trademark Office.