

Owner's Manual

Fixed Flat Screen Wall Mount

MODEL: DWF60100XX

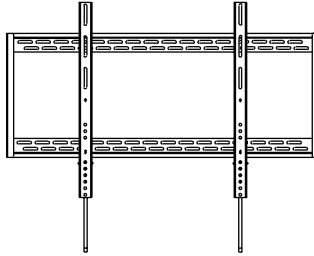

CAUTION: DO NOT EXCEED MAXIMUM LISTED WEIGHT CAPACITY. SERIOUS INJURY OR PROPERTY DAMAGE MAY OCCUR!



200x200/ 300x300/
400x200/400x400/
600x400/800x400/
800x600/900x600

100"
MAX



Este manual esta disponible en español en la página de Tripp Lite: www.tripplite.com

Ce manuel est disponible en français sur le site Web de Tripp Lite : www.tripplite.com

Русскоязычная версия настоящего руководства представлена на веб-сайте компании Tripp Lite по адресу: www.tripplite.com

Dieses Handbuch ist in deutscher Sprache auf der Tripp Lite-Website verfügbar: www.tripplite.com

PROTECT YOUR INVESTMENT!

Register your product for quicker service
and ultimate peace of mind.

You could also win an ISOBAR6ULTRA
surge protector—a \$50 value!

www.tripplite.com/warranty

TRIPP·LITE



1111 W. 35th Street, Chicago, IL 60609 USA • www.tripplite.com/support

Copyright © 2014 Tripp Lite. All rights reserved.

NOTE: Read the entire instruction manual before you start installation and assembly.



WARNING

- Do not begin the installation until you have read and understood the instructions and warnings contained in this manual. If you have any questions regarding any of the instructions or warnings, please visit www.triplite.com/support.
- This mounting bracket was designed to be installed and utilized **ONLY** as specified in this manual. Improper installation of this product may cause damage or serious injury.
- This product should only be installed by someone of good mechanical ability, with basic building experience and a full understanding of this manual.
- Make sure that the supporting surface will safely support the combined load of the equipment and all attached hardware and components.
- If mounting to wood wall studs, make sure that mounting screws are anchored into the center of the studs. The use of a stud finder is highly recommended.
- Always use an assistant or mechanical lifting equipment to safely lift and position equipment.
- Tighten screws firmly, but do not over tighten. Over tightening can damage the items, greatly reducing their holding power.
- This product is intended for indoor use only. Using this product outdoors could lead to product failure and personal injury.

Warranty & Product Registration

5-Year Limited Warranty

Seller warrants this product, if used in accordance with all applicable instructions, to be free from original defects in material and workmanship for a period of 5 years from the date of initial purchase. If the product should prove defective in material or workmanship within that period, Seller will repair or replace the product, in its sole discretion.

THIS WARRANTY DOES NOT APPLY TO NORMAL WEAR OR TO DAMAGE RESULTING FROM ACCIDENT, MISUSE, ABUSE OR NEGLIGENCE. SELLER MAKES NO EXPRESS WARRANTIES OTHER THAN THE WARRANTY EXPRESSLY SET FORTH HEREIN. EXCEPT TO THE EXTENT PROHIBITED BY APPLICABLE LAW, ALL IMPLIED WARRANTIES, INCLUDING ALL WARRANTIES OF MERCHANTABILITY OR FITNESS, ARE LIMITED IN DURATION TO THE WARRANTY PERIOD SET FORTH ABOVE; AND THIS WARRANTY EXPRESSLY EXCLUDES ALL INCIDENTAL AND CONSEQUENTIAL DAMAGES. (Some states do not allow limitations on how long an implied warranty lasts, and some states do not allow the exclusion or limitation of incidental or consequential damages, so the above limitations or exclusions may not apply to you. This warranty gives you specific legal rights, and you may have other rights which vary from jurisdiction to jurisdiction).

WARNING: The individual user should take care to determine prior to use whether this device is suitable, adequate or safe for the use intended. Since individual applications are subject to great variation, the manufacturer makes no representation or warranty as to the suitability or fitness of these devices for any specific application.

PRODUCT REGISTRATION

Visit www.triplite.com/warranty today to register your new Tripp Lite product. You'll be automatically entered into a drawing for a chance to win a FREE Tripp Lite product!*

* No purchase necessary. Void where prohibited. Some restrictions apply. See website for details.

Tripp Lite has a policy of continuous improvement. Specifications are subject to change without notice.

Component Checklist

IMPORTANT: Ensure that you have received all parts according to the component checklist prior to installing. If any parts are missing or faulty, visit www.triplite.com/support for service.

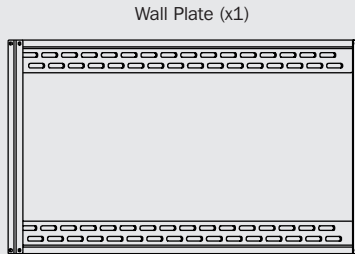

Adapter Bracket (x2)

Package M



M5X14 (x4)

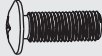

M6X14 (x4)



M8X20 (x4)



M6X30 (x4)



M8X30 (x4)



Washer (x4)



Small Spacer (x8)



Big Spacer (x4)

Package W

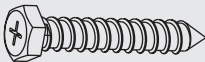

Anchor Bolt (x6)



Concrete Anchor (x6)



D8 Washer (x6)

1a. Wood Stud Wall Mounting

{Fits 406mm (16") / 450mm (17.7") / 600mm (23.6")/610mm (24") stud}

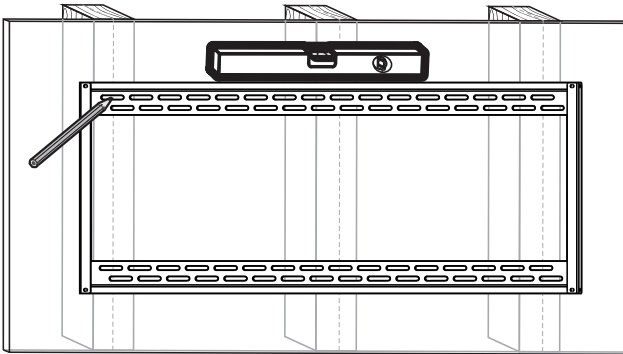
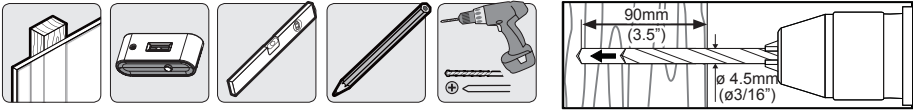

Find and mark the exact location of mounting holes

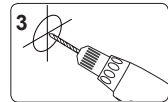

Drill pilot holes

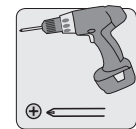
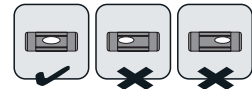
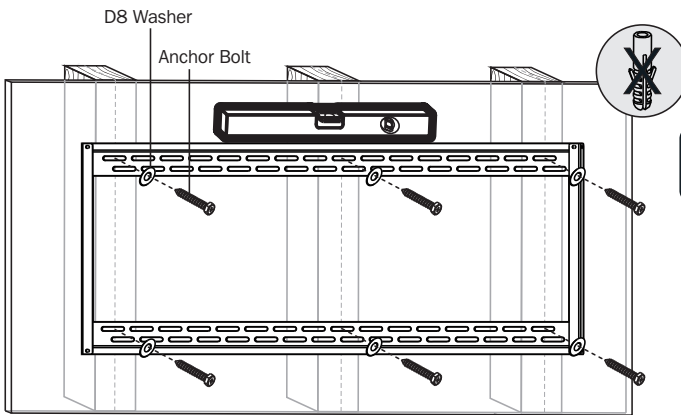

Screw the wall plate onto the wall

⚠ WARNING

- Make sure that mounting screws are anchored into the center of the studs. Use of a stud finder is highly recommended.
- Installers are responsible to provide hardware for other types of mounting situations.
- Installers must verify that the supporting surface will safely support the combined load of the equipment and all attached hardware and components.

1b. Solid Brick and Concrete Mounting

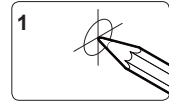
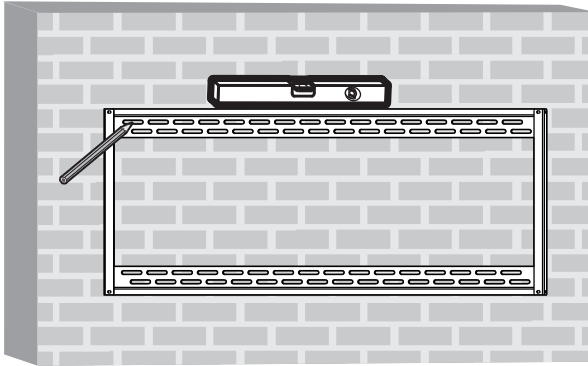
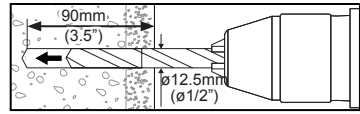
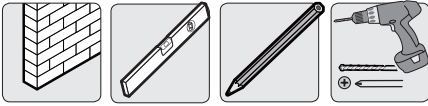

1
Mark the exact location of mounting holes

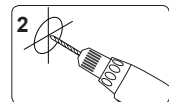

2
Drill pilot holes

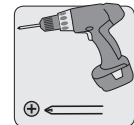
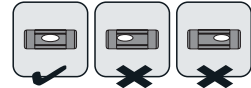
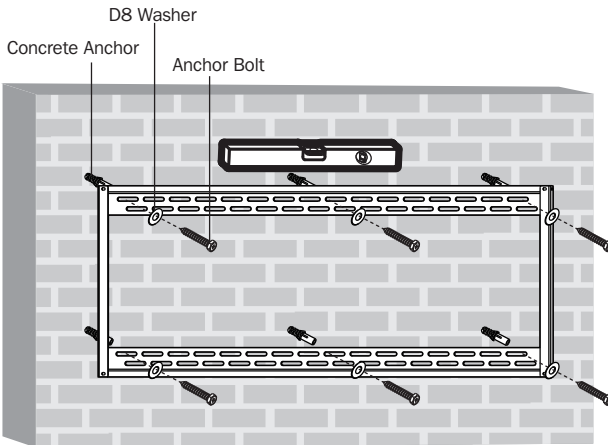

Screw the wall plate onto the wall

WARNING

- When installing wall mounts on cinder block, verify the actual concrete thickness is at least 1-3/8" (35mm) for using the concrete anchors. Do not drill into mortar joints! Be sure to mount in a solid part of the block, generally 1" (25mm) minimum from the side of the block. It is suggested an electric drill on a slow setting be used to drill the hole instead of a hammer drill to avoid breaking out the back of the hole when entering a void or cavity.
- Installers must verify that the supporting surface will safely support the combined load of the equipment and all attached hardware and components.

2. Installing the Adapter Brackets

2-1 For Flat Back Screen

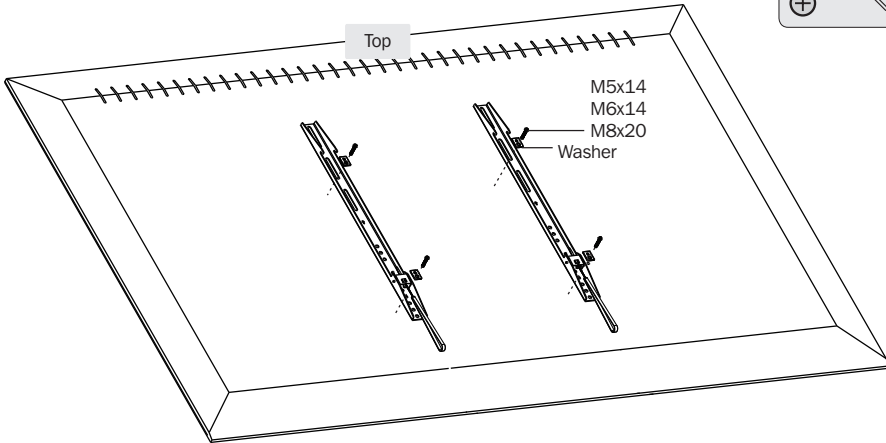
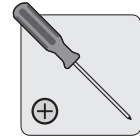
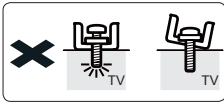
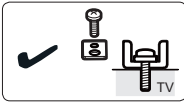

2-2 For Recessed Back Screen or to Access A/V Inputs

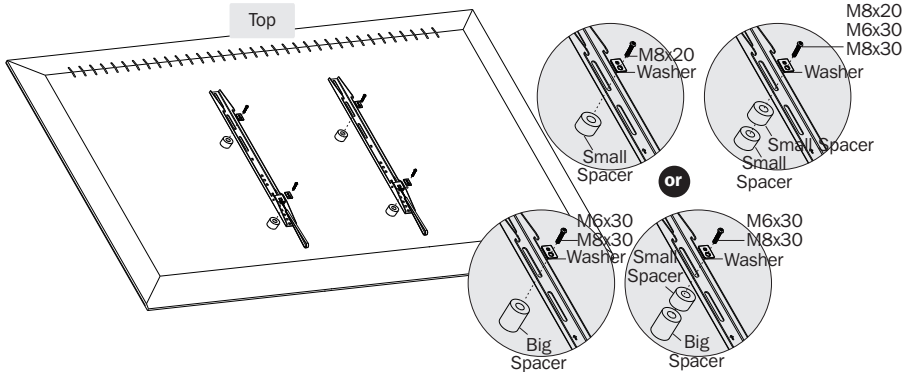
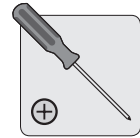
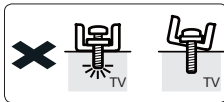
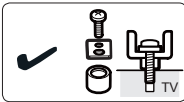

Note: Choose appropriate screws, washers and spacers (if necessary) according to the type of screen.

- Position the adapter brackets as close as possible to the center of the display.
- Screw the adapter brackets onto the display.



Tighten all screws but do not over tighten.

3. Attaching/Removing Display

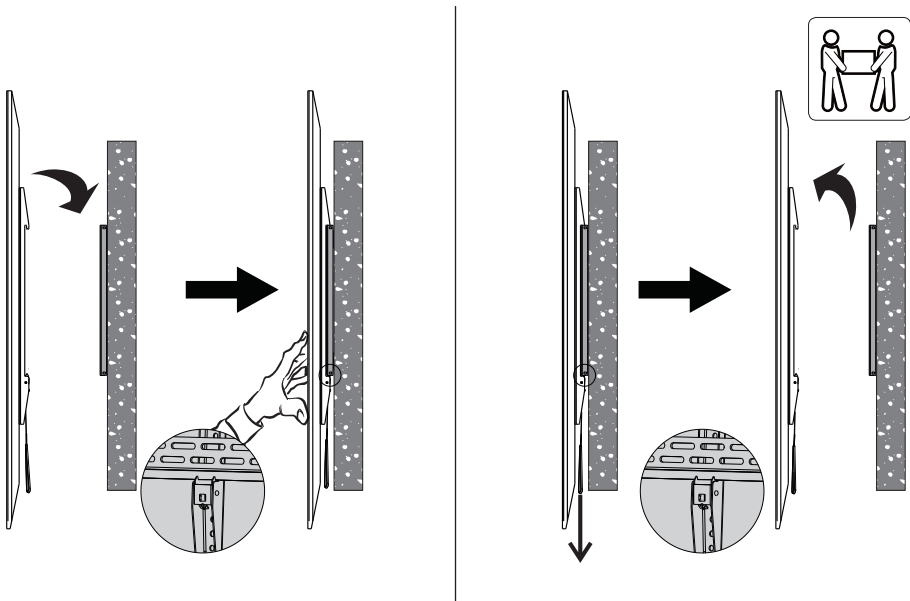

- Before releasing the display, make sure adapter brackets have been safely attached to the wall plate.

Maintenance

- Check that the bracket is secure and safe to use at regular intervals (at least every three months).
- Please visit www.tripplite.com/support if you have any questions.



1111 W. 35th Street, Chicago, IL 60609 USA • www.tripplite.com/support