

Owner's Manual

NetCommander® IP Cat5 KVM Switch

Models: B070-008-19-IP, B070-016-19-IP, B072-008-1-IP, B072-016-1-IP
(Series Number: AG-00C3)

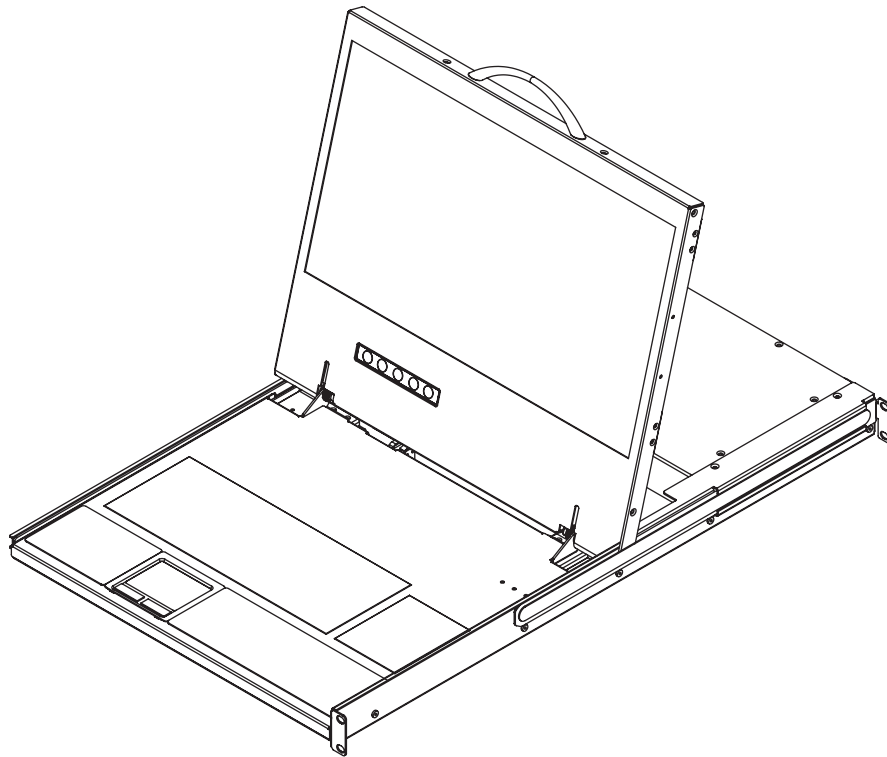

PROTECT YOUR INVESTMENT!

Register your product for quicker service and ultimate peace of mind.

You could also win an ISOBAR6ULTRA surge protector—a \$50 value!

www.tripplite.com/warranty



1111 W. 35th Street, Chicago, IL 60609 USA • www.tripplite.com/support

Copyright © 2014 Tripp Lite. All rights reserved. All trademarks are the property of their respective owners.
The policy of Tripp Lite is one of continuous improvement. Specifications are subject to change without notice.

Table of Contents

| | | | |
|---|-----------|--|-----------|
| Legal Notice | 3 | 3. Conducting a Remote Session | 36 |
| 1. Product Overview | 3 | 3.1 Starting a Remote Session | 36 |
| 1.1 Features and Benefits | 3 | 3.2 Remote Session Toolbar | 37 |
| 1.2 Terminology | 4 | 3.2.1 Pin Toolbar | 37 |
| 1.3 Target Server Compatibility | 4 | 3.2.2 Session | 37 |
| 1.4 Client Computer Compatibility | 4 | 3.2.3 Video | 39 |
| 1.5 Safety | 4 | 3.2.4 Power | 40 |
| 1.6 System Components | 5 | 3.2.5 Keys | 41 |
| 1.7 The NetCommander IP Unit | 6 | 3.2.6 Mouse | 43 |
| 1.8 Rackmounting the NetCommander IP | 8 | 3.2.7 Server/Serial | 46 |
| 1.8.1 Standard Console KVM Switch Instructions | 8 | 3.2.8 Full Screen | 46 |
| 1.8.2 2-Post Rack Console KVM Switch Instructions | 8 | 3.2.9 Logout | 46 |
| 1.9 Connecting the System | 9 | 3.3 Shared Session | 46 |
| 1.10 Initial Settings (Default IP Address) | 9 | 3.4 Exclusive Session | 46 |
| 2. Web Configuration Interface | 13 | 4. Local Console | 47 |
| 2.1 Logging Into the Web Configuration Interface | 13 | 4.1 Move Label (F1) | 47 |
| 2.2 Web Configuration Interface Layout | 14 | 4.2 Tuning (F5) | 47 |
| 2.3 My Targets Section | 15 | 4.3 Power Management | 48 |
| 2.4 Configuration Section | 16 | 4.4 (F2) Setting | 48 |
| 2.4.1 Firmware Upgrade | 17 | 5. Serial Port Pinout | 51 |
| 2.4.2 Backup/Restore | 19 | 6. Security Certificate Installation | 51 |
| 2.4.3 SSL Certificate | 20 | 7. Technical Specifications | 57 |
| 2.4.4 Device | 21 | 8. Video Resolution and Refresh Rates | 58 |
| 2.4.5 Users | 22 | 9. Warranty & Warranty Registration | 58 |
| 2.4.6 Switch Configuration | 24 | | |
| 2.4.7 User Targets | 25 | | |
| 2.4.8 Power Devices | 25 | | |
| 2.4.9 Power Outlets | 27 | | |
| 2.4.10 Serial Ports | 28 | | |
| 2.4.11 Security | 28 | | |
| 2.4.12 Authentication | 30 | | |
| 2.4.13 Date & Time | 34 | | |
| 2.5 Password Section | 34 | | |
| 2.6 Events Section | 35 | | |

Legal Notice

This manual and the software described in it are furnished under license, and may be used or copied only in accordance with the terms of such license. The content of this manual is provided for informational use only, and is subject to change without notice. It should not in and of itself be construed as a commitment by Tripp Lite, which assumes no responsibility of liability for any errors or inaccuracies that may appear in this book.

The software that accompanies this manual is licensed for use by the Licensee only, in strict accordance with the software license agreement, which the Licensee should read carefully before commencing use of the software. Except as permitted by the license, no part of this publication may be reproduced, stored in retrieval system, or transmitted in any form or by any means, electronic, mechanical, recording, or otherwise, without the prior written permission of Tripp Lite.

1. Product Overview

1.1 Features and Benefits

- Directly connect up to 16 (B070-016-19-IP or B072-016-1-IP) or 8 (B070-008-19-IP or B072-008-1-IP) computers/servers.
- Up to 2 users (1 local, 1 remote) can simultaneously access the KVM
- Up to 5 users can share a single remote session
- Multi-level account access: *Administrator* and *User* account types.
- Remote authentication support; RADIUS and LDAP/S
- Supports both IPv4 and IPv6
- PDU Control - Add IP PDUs as devices that can be controlled by the KVM. Assign individual ports on the KVM to a PDU port to power cycle or power off/on the computer/server connected to that port.
- BIOS level control to any server's brand and model, regardless of the server condition and network connectivity. Covers the entire spectrum of crash scenarios.
- Compatible with Windows and Linux operating systems.
- Connect computer/servers up to 100 ft. (30 m.) away from the KVM using inexpensive Cat5e/6 cabling and B078-101-USB2, B078-101-USB-1 and B078-101-PS2 SIUs
- Java-based application allows control of a target server via web browser from any location over a secured IP connection.
- Features two 10/100 Mbps LAN ports, so that if one fails, the other takes over.
- Supports the highest security standards for encryption (128-bit AES and HTTPS).
- Virtual Media allows an .iso file located in a Shared folder of a SAMBA or NFS server to be mounted to a Target Server and accessed as if it were directly stored on it.
- Supports Virtual Media data transfer rates up to 12Mbps (B078-101-USB2 required). A B078-101-USB-1 can be used to provide Virtual Media support, but only at speeds up to 1Mbps.
- Event log records events that take place on the installation, such as logins, reboots, network settings changes, etc..
- Features two RJ45 serial ports for connecting serial manageable devices, such as PDUs, firewalls, and routers.
- Allows for system sent messages to SNMP server to notify of LAN failures.
- Allows for the installation of a SSL certificate to ensure secure transactions between the Web servers and browsers.
- Graphical OSD and toolbars provide convenient, user-friendly remote operation.
- Text based OSD provides convenient, user-friendly local operation.
- Supports video resolutions up to 1920 x 1080 @ 60Hz. (B070-console KVMs are limited to video resolutions up to 1366 x 768 at the local console.)
- Flash upgradeable firmware over the network.

1. Product Overview

1.2 Terminology

The following table describes terms used in this guide.

| Term | Definition |
|------------------------|---|
| Target Server | The computer/server that is connected directly to the KVM, and which is accessed via the local console or by a Client Computer running a remote session. |
| Client Computer | A computer running a remote session, which is used to access computer/servers or devices connected to the KVM. |
| Remote Session | The process of remotely accessing the KVM via Client Computer, and controlling Target Servers and other connected devices. |
| RICCs/ROCs/SIUs | RICC, ROC, and SIU refer to the dongles that are used to connect the KVM switch to a computer/server via Cat5e/6 cable. RICCs are the earliest versions of these dongles, and stand for Remote Interface Connection Cable. ROCs are the second generation of these dongles, and stand for RICC on Cable. SIUs are the current versions of these dongles, and stand for Server Interface Units. Functionally, they all serve the same purpose. The B078-101-PS2, B078-101-USB-1, and B078-101-USB2 are the SIUs that will be used with the NetCommander UP KVM Switches. |

1.3 Target Server Compatibility

- PS/2 and USB computers/servers
- Computer/servers with a HD15 (VGA) port
- Computer/servers running Windows or Linux operating systems

1.4 Client Computer Compatibility

- Pentium 4 with 2 GB memory
- Supports Windows and Linux operating systems.
- Windows operating systems can use Internet Explorer, Firefox, or Chrome browsers.
- Linux operating systems can use Firefox or Chrome browsers.

1.5 Safety

- Read all of these instructions. Save them for future reference.
- Follow all warnings and instructions marked on the device.
- Use of this equipment in life support applications where failure of this equipment can reasonably be expected to cause the failure of the life support equipment or to significantly affect its safety or effectiveness is not recommended. Do not use this equipment in the presence of a flammable anesthetic mixture with air, oxygen or nitrous oxide.
- This device is designed for IT power distribution systems with up to 230V phase-to-neutral voltage.
- Do not place the device on any unstable surface (cart, stand, table, etc.). If the device falls, serious damage will result.
- Do not use the device near water.
- Do not place the device near, or over, radiators or heat registers.
- The device cabinet is provided with slots and openings to permit adequate ventilation. To ensure reliable operation and protect against overheating, these openings must never be blocked or covered.
- The device should not be placed on a soft surface (bed, sofa, rug, etc.), as this will block its ventilation openings. Likewise, the device should not be placed in a built-in enclosure unless adequate ventilation has been provided.
- Never spill liquid of any kind on the device.
- Unplug the device from the wall outlet before cleaning. Use a damp cloth for cleaning. Do not use liquid or aerosol cleaners.
- The device should be operated from the type of power source indicated on the marking label. If you are not sure of the type of power available, consult your dealer or local power company.
- To prevent damage to your installation, ensure that all devices are properly grounded.
- The device is equipped with a 3-wire grounding type plug. This is a safety feature. If you are unable to insert the plug into the outlet, contact your electrician to replace your obsolete outlet. Do not attempt to defeat the purpose of the grounding-type plug. Always follow your local/national wiring codes.
- Position system cables and power cables carefully to ensure that nothing rests on any cable. Route the power cord and cables so that they cannot be stepped on or tripped over.

1. Product Overview

- If an extension cord is used with this device, make sure that the total ampere rating of all products used on the cord does not exceed the extension cord ampere rating. Make sure that the total of all products plugged into the wall outlet does not exceed 15 amperes.
- To help protect your system from sudden transient increases and decreases in electrical power, it is recommended that you plug your devices into a Tripp Lite surge suppressor, line conditioner, or uninterruptible power supply (UPS).
- When connecting or disconnecting power to hot-pluggable power supplies, observe the following precautions:
 - o Install the power supply before connecting the power cable to the power supply
 - o Unplug the power cable before removing the power supply
 - o If the system has multiple sources of power, disconnect power from the system by unplugging all power cables from the power supplies
 - o Never push objects of any kind into or through cabinet slots. They may touch dangerous voltage points or short out parts, resulting in a risk of fire or electrical shock
 - o Do not attempt to service the device yourself. Refer all servicing to qualified service personnel
- If the following conditions occur, unplug the device from the wall outlet and bring it to qualified service personnel for repair:
 - o The power cord or plug has become damaged or frayed
 - o Liquid has been spilled into the device
 - o The device has been exposed to rain or water
 - o The device has been dropped or the cabinet has been damaged
 - o The device exhibits a distinct change in performance, indicating a need for service
 - o The device does not operate normally when the operating instructions are followed
- Adjust only those controls that are covered in the operating instructions. Improper adjustment of other controls may result in damage that will require extensive repair work by a qualified technician.

1.6 System Components

Before installing the NetCommander IP, verify that you have all the components on the following list, as well as any other items required for installation.

- B070-008-19-IP, B070-016-19-IP, B072-008-1-IP or B072-016-1-IP NetCommander IP KVM
- A B078-101-PS2, B078-101-USB-1 or B078-101-USB2 (ordered separately) for each computer/server you will be connecting.
- Cat5e/6 cable (ordered separately) for each computer/server you will be connecting, as well as for network and serial connections.
- Rackmount hardware (included).
- Power cord (included).

1. Product Overview

1.7 The NetCommander IP Unit

Console KVM Switch Front View

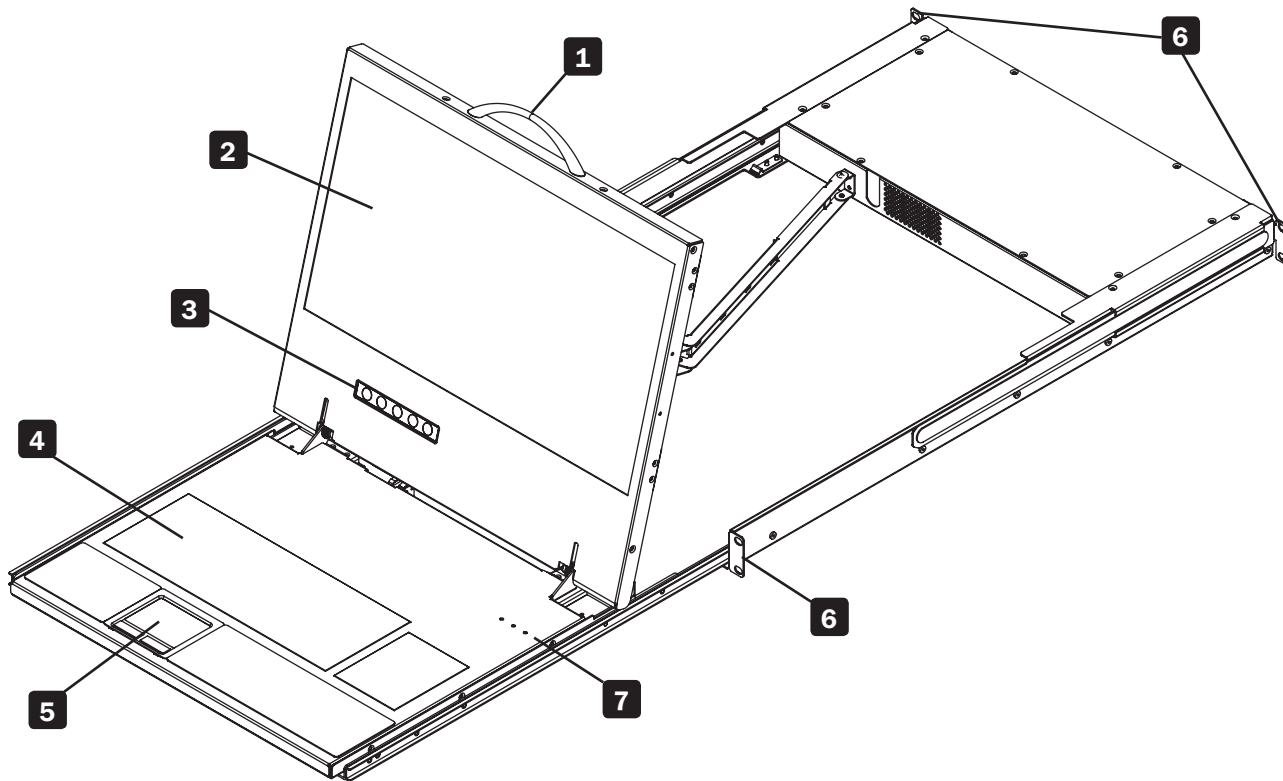

- 1 Upper Handle** – Pull to slide the console out; push to slide the console in.
- 2 19" LCD Screen** – After sliding the console out, flip up the cover to access the LCD screen, keyboard and touchpad.
- 3 LCD Controls** – The LCD On/Off button is located here, as well as buttons to control the position and picture settings of the LCD screen.
- 4 Keyboard**
- 5 2-Button Touchpad**
- 6 Rackmounting Brackets** – There are rackmount brackets to secure the chassis to a system rack located at each corner of the unit.
- 7 Lock LEDs** – The Num Lock, Caps Lock, and Scroll Lock LEDs are located here.

1. Product Overview

Console KVM Switch Rear View

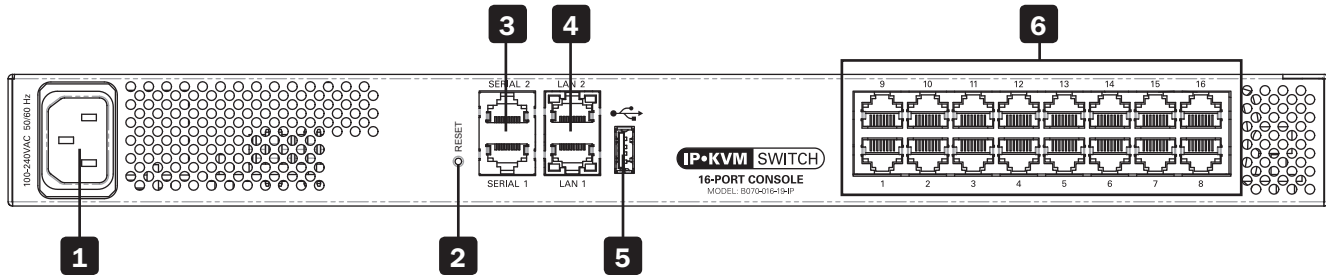

- 1 Power Outlet** – The power cord included with the console connects to the unit here.
- 2 Reset Button** – Pressing this button for 10 seconds restores the system to its factory default settings.
- 3 Serial Ports 1 and 2** – The KVM features two RJ45 serial ports for connecting serial manageable devices, such as PDUs, firewalls, and routers (see the Serial Pinout section in this manual for the pinout information).
- 4 LAN Ports 1 and 2** – The KVM features two RJ45 LAN ports for connecting to 10/100 Mbps networks. If LAN 1 goes down, LAN 2 takes over. When LAN 1 becomes operational again, the KVM will need to be rebooted to make it the default LAN port again. **Note:** Only one LAN port can be turned on at a time; they cannot both be turned on. If you don't wish to use network redundancy, connect a single network cable to the LAN 2 Port.
- 5 USB Port** – This port currently serves no functional purpose. It is included for future functionality upgrades.
- 6 Server Ports** – When connecting a computer/server, Cat5e/6 cabling connects from an available server port to a B078-101-PS2, B078-101-USB-1 or B078-101-USB2 SIU which in turn connects to the computer/server.

Rackmount KVM Switch Front View

The NetCommander IP front panel is illustrated in the figure below. **Note:** The figure below shows a B072-016-1-IP, but the front panel will be functionally the same for all models.

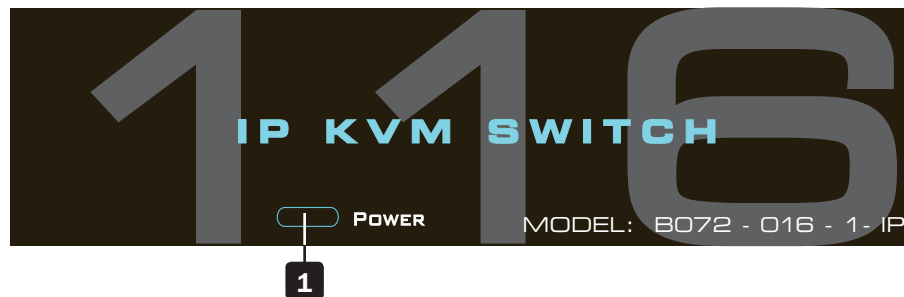

- 1 Power LED** – This Blue LED illuminates to indicate that the unit is powered on. No light indicates that the unit is powered off. When a LAN redundancy event occurs, and LAN 2 takes over for LAN 1, this LED will blink slowly. To stop the LED from blinking after a redundancy event, the KVM must be powered off and back on.

1. Product Overview

Rackmount KVM Switch Rear View

The NetCommander IP back panel is illustrated in the figure below. **Note:** The figure below shows the back panel for a B072-016-1-IP, but the back panel will be functionally the same for all models, with the only difference being the number of server ports.

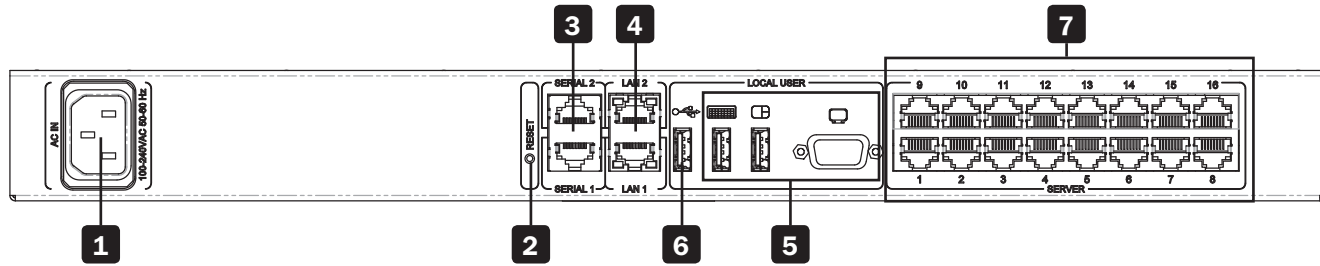

- 1 Power Outlet** – The power cord included with the KVM connects to the unit here.
- 2 Reset button** – Pressing this button for 10 seconds restores the system to its factory default settings.
- 3 Serial Ports 1 and 2** – The KVM features two RJ45 serial ports, for connecting serial manageable devices, such as PDUs, firewalls, and routers. (see the Serial Pinout section in this manual for the pinout information)
- 4 LAN Ports 1 and 2** – The KVM features two RJ45 LAN ports for connecting to 10/100 Mbps networks. If LAN 1 goes down, LAN 2 takes over. When LAN 1 becomes operational again, the KVM will need to be rebooted to make it the default LAN port again. **Note:** Only one LAN port can be turned on at a time; they cannot both be turned on. If you don't wish to use network redundancy, connect a single network cable to LAN 2 Port.
- 5 Console KVM ports** – A USB keyboard and mouse, and VGA (HD15) monitor connect here for local operation of the NetCommander IP KVM.
- 6 USB Port** – This port currently serves no functional purpose. It is included for future functionality upgrades.
- 7 Server ports** – When connecting a computer/server, Cat5e/6 cabling connects from an available server port to a B078-101-PS2, B078-101-USB-1 or B078-101-USB2 SIU which in turn connects to the computer/server.

1.8 Rackmounting the NetCommander IP

Follow all instructions in the safety section of this manual before rackmounting. Make sure to write down the MAC Address and Device Number from the bottom of the unit before rackmounting, as they will be useful when finding the IP address assigned by the DHCP server. For the B072-Series, attach the included mounting brackets to the sides of the KVM switch (either front or rear, depending on user preference) using the included hardware, and then mount the KVM into your rack using user supplied screws. The B070-Series Console KVM Switches come with removable rackmount brackets, allowing the unit to be installed by a single person.

1.8.1 Standard Console KVM Switch Instructions

- 1** Remove the rackmount brackets from the unit and mount them to the back of the rack using user-supplied screws.
- 2** Take the Console KVM switch and gently slide it into the rack so that it inserts into the rackmount brackets you just mounted.
- 3** Mount the rackmount brackets on the front of the unit to the rack using user-supplied screws.

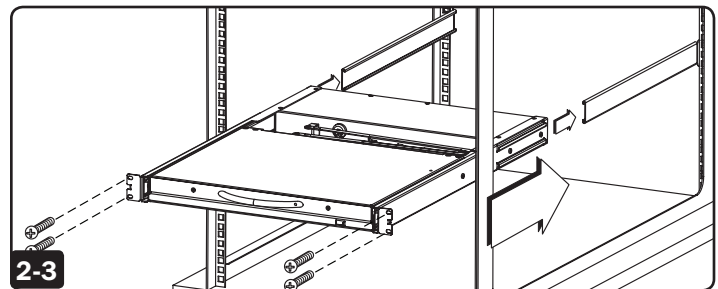
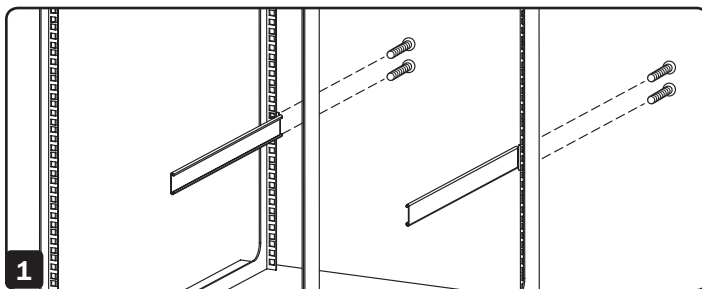

1.8.2 2-Post Rack Console KVM Switch Instructions

The B070-Series Console KVM Switches can be mounted to a 2-Post Rack using Tripp Lite's B019-000 2-Post Rackmount Kit (sold separately). See the B019-000 owner's manual for installation instructions.

1. Product Overview

1.9 Connecting the System

The figure below illustrates the NetCommander IP system overview. **Note:** The figure below shows a B072-016-1-IP. The only difference in set up between models is the number of ports, and the lack of an external console on the B070-Series console KVMs.

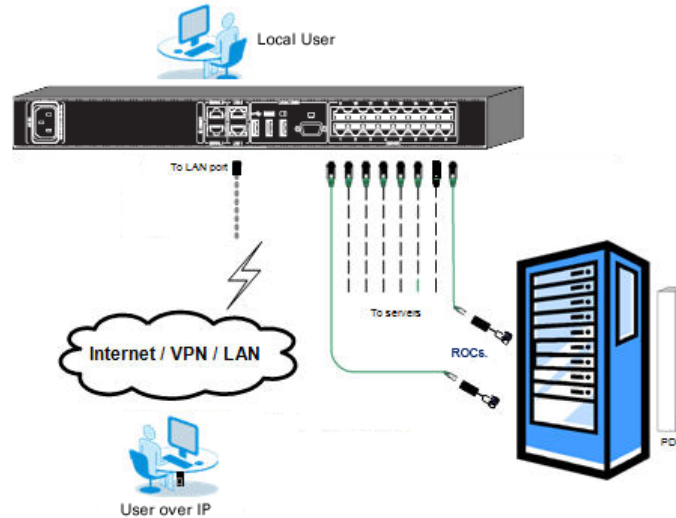

1. Make sure that power to all the devices you will be connecting has been turned off.
2. **(B072-Series KVM Switches Only)** Connect a VGA cable from the monitor to the HD15 (VGA) port on the back of the KVM.
3. **(B072-Series KVM Switches Only)** Connect the keyboard's USB connector to the USB Keyboard port on the back of the KVM.
4. **(B072-Series KVM Switches Only)** Connect the mouse's USB connector to the USB Mouse port on the back of the KVM.
5. Connect a Cat5e/6 cable from an available server port on the back of the KVM to a SIU (B078-101-PS2, B078-101-USB-1 or B078-101-USB2) appropriate for the computer you are adding.
6. Connect the SIU's connectors to the corresponding ports on the computer/server.
7. Repeat steps 5 and 6 for each computer/server you are adding.
8. Connect a Cat5e/6 cable from your network to the LAN 1 port on the back of the KVM.
9. Connect a second Cat5e/6 cable from your network into the KVM's LAN 2 port.
10. **Optional:** Connect up to two serial devices to the RJ45 Serial Ports 1 and 2 on the back of the KVM switch (See the *Configuring Serial Port Settings* section of this manual for details on configuration. See the *Serial Pinout* section in this manual for the pinout information).
11. Connect the included power cord between the C14 outlet on the back of the unit and a Tripp Lite Surge Suppressor, Power Distribution Unit (PDU), or Uninterruptible Power Supply (UPS). There is no Power On/Off switch, so plugging in the power cord will power on the KVM.
12. Turn on the power to all of the connected devices.

1.10 Initial Settings (Default IP Address)

By default, the NetCommander IP is set to have the network's DHCP server pull an IPv4 address for it. Referencing the unit's Mac address, which can be found on the bottom panel of the KVM, have your network administrator provide you with the IP address that was assigned by the DHCP server. You can also obtain the IP address by logging into the KVM's OSD via the local console, and navigating to the F2 Settings menu.

On networks that do not have a DHCP server, the KVM boots with the default static IPv4 address of 192.168.0.254.

Note: There is no default IPv6 address for the KVM switch. An IPv6 address can be automatically assigned via DHCP server, a Stateless address can be assigned, or a static address can be manually entered.

To configure an IP address for the KVM, you can use the local console OSD or the Web Configuration Interface. Both methods are described in the following sections.

1. Product Overview

To set the IPv4 address via the local console OSD:

1. From the local console, press the left **[Shift]** key twice to open the OSD.
2. Press the **[F2]** key to open the *Settings* menu.
3. In the *Settings* menu, press the **[Tab]** key until the *DHCP* field is highlighted. Press the **[Spacebar]** key to toggle the *DHCP* field from *Enabled* to *Disabled*.
4. Pressing the **[Tab]** key to navigate to the additional fields, type in the desired IP Address, Subnet Mask, Gateway and DNS Server Address (optional).
5. Once the IP address is satisfactory, press the **[Esc]** key to save your changes. This will require that the KVM be rebooted to save the new settings.

```
TRIPPLITE NETCOMMANDER
MAIN

-- NAME                USER  PM
01 Server 01          *
02 Server 02          *
03 Server 03          *
04 Server 04
05 Server 05
06 Server 06
07 Server 07
08 Server 08
MOVE LABEL F1      ESC-LOGOUT
TUNING           F5      F2-SETTING
```

```
TRIPPLITE NETCOMMANDER
SETTINGS

MAC ADDR 00:15:9D:02:ED:E6
DHCP ENABLED
IP ADDRESS 172.72 .0 .27
SUBNET MASK 255.255.0 .0
GATEWAY 172.72 .0 .1
DNS IP(Opt) 172.72 .5 .30
HOTKEY :Shift-Shift
KEYBOARD LANGUAGE :English

Toggle-Space  Navigate-Tab
DDC-F10      Next-F2      Save-ESC
```

To set the IPv6 address via the local console OSD:

1. From the local console, press the left **[Shift]** key twice to open the OSD.
2. Press the **[F2]** key to open the Settings menu, and then press the **[F2]** key again to open the IPv6 Settings menu.
3. In the IPv6 Settings menu, with the Mode field at the top of the screen highlighted, press the **[Spacebar]** key to toggle between DHCP, Stateless, and Static. DHCP is selected by default, and automatically assigns an IP address via the IPv6 DHCP server. Stateless is an option for networks with a compliant router that performs Stateless IPv6 configuration. Static allows you to manually assign an IP address.
4. Pressing the **[Tab]** key to navigate to the additional fields, type in the desired IP Address, Gateway, and DNS Server Address (optional).
Note: DNS IP should be set to 0.0.0.0 to indicate no DNS.
5. Once the IP address is satisfactory, press the **[Esc]** key twice to exit and save your changes. This will require that the KVM be rebooted to save the new settings.

```
TRIPPLITE NETCOMMANDER
IPV6 SETTINGS

Mode DHCP
IP ADDRESS
2001:db8:0:1::12d / 64
DEFAULT GATEWAY
fe80::21b:21ff:fe0d:
f959
DNS IP (Optional)
2001:db8:0:1::128

Toggle-Space  Navigate-Tab
Back-ESC
```

To set the IP address via the Web Configuration Interface:

Note:

- Before logging on the first time, verify that you have the latest Java installed on your computer (Java 1.6 or higher is required). If not, you can download and install Java from <http://www.java.com/en/download/index.jsp>.
 - Only SSL connections are allowed, so you must start the IP address with HTTPS, not HTTP.
1. Open your web browser (see the *Client Computer Compatibility* section of this manual for browser support) and enter in the IP address of the KVM.
 2. When logging into the KVM from your web browser, a Security Alert message appears to inform you that the device's certificate is not trusted, and asks if you want to proceed. You have two options:
 - If you are working on a computer other than your own, accept the certificate for just this session by clicking to proceed.
 - If you are working at your own computer, install the certificate. Reference the instructions in the *Security Certificate Installation* section of this manual.

1. Product Overview

3. Upon installing the certificate or accepting the unrecognized certificate for the current session, the initial web page appears, and the Java application is launched. Before the installation completes, a security warning may appear stating that the connection to this website is untrustworthy. This is a security issue similar to one you get from your web browser. You can choose to continue anyway, or install the certificate in the Java control panel. Refer to the *Security Certificate Installation* section of this manual for further instructions.
4. After the Java application is launched, the login page appears. If the login page does not appear on its own, click the *Log On* button in the center of the web page to bring it up. If clicking on the *Log On* button does not bring up the login page, add */targets.jnlp* to the end of your IP address.

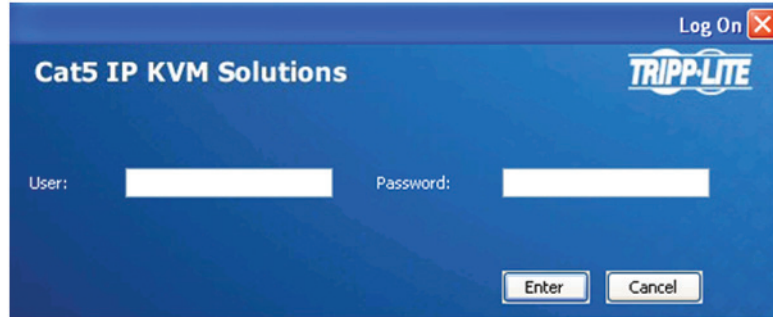

5. Enter in your username and password, and press *Enter*. If this is the first time you are accessing the KVM, enter in the default username (*admin*) and password (*access*). The *My Targets* page of the Web Configuration Interface opens, showing the state of your unit, and displaying all your available Target Servers.

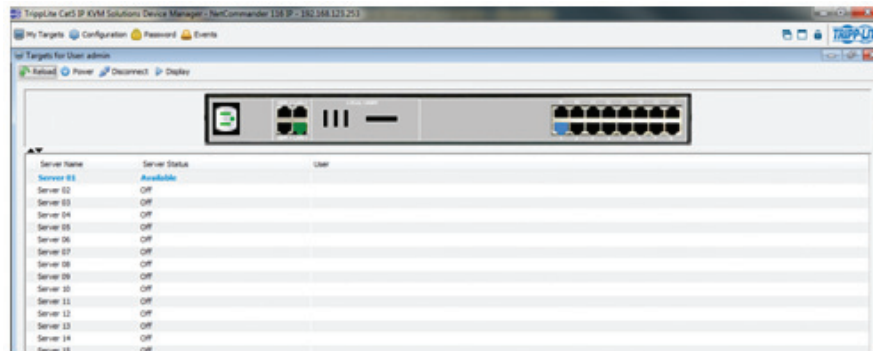

6. Click on the *Configuration* icon at the top of the screen to pull up the KVM's *Configuration* screen. It opens with the *Device* tab displayed.

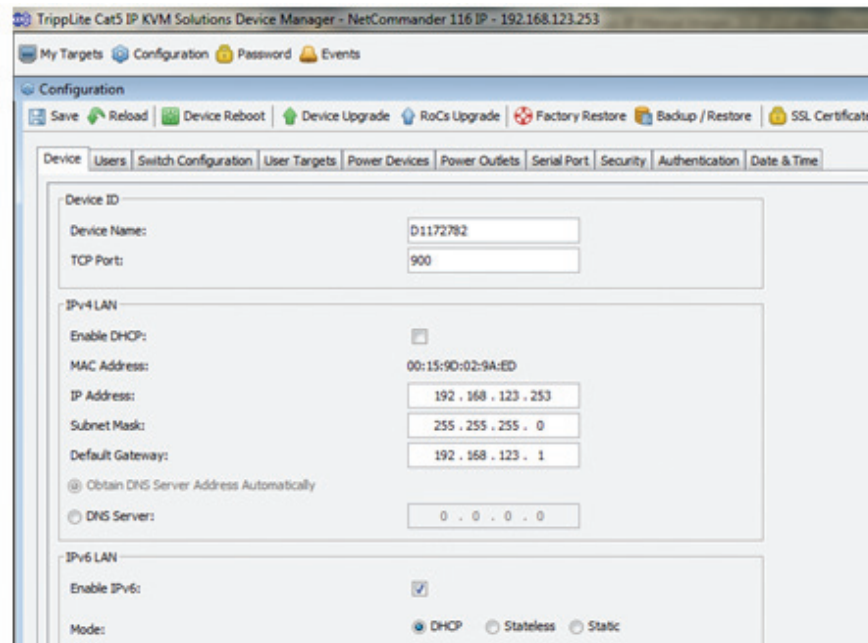

1. Product Overview

7. There are two LAN sections in the Device tab, one for IPv4 and one for IPv6. For IPv4, you have the options of automatically assigning an address via DHCP server (default) and manually assigning an address. For IPv6, you have the options of automatically assigning an address via DHCP server (default), automatically assigning a stateless address, manually assigning an address, or disabling IPv6 altogether. Make the desired selections, depending on how you wish the IP address to be assigned.
8. Populate the fields in the IPv4 or IPv6 sections with the desired network information.
9. Click the Save icon in the toolbar above the Configuration menu tabs to save the network settings. Upon clicking Save, you will be prompted to reboot the KVM to finish the implementation of the new Device settings. Click Yes to proceed.

2. Web Configuration Interface

The NetCommander IP can be accessed in two ways: locally via the local console OSD, or remotely via the Web Configuration Interface. This section of the manual details the Web Configuration Interface, which can be used to access the computer/servers and other devices connected to the KVM, as well as to configure the KVM's settings and accounts.

2.1 Logging Into the Web Configuration Interface

Note:

- Before logging on the first time, verify that you have the latest Java installed on your computer (Java 1.6 or higher is required). If not, you can download and install Java from <http://www.java.com/en/download/index.jsp>.
 - Only SSL connections are allowed, so you must start the IP address with HTTPS, not HTTP.
1. Open your web browser (see the *Client Computer Compatibility* section of this manual for browser support) and enter in the IP address of the KVM.
 2. When logging into the KVM from your web browser, a Security Alert message appears to inform you that the device's certificate is not trusted, and asks if you want to proceed. You have two options:
 - If you are working on a computer other than your own, accept the certificate for just this session by clicking to proceed.
 - If you are working at your own computer, install the certificate. Reference the instructions in the *Security Certificate Installation* section of this manual.
 3. Upon installing the certificate or accepting the unrecognized certificate for the current session, the Java application begins to install. Before the installation completes, a security warning may appear stating that the connection to this website is untrustworthy. This is a security issue similar to one you get from your web browser. You can choose to continue anyway, or install the certificate in the Java control panel. Refer to the *Security Certificate Installation* section of this manual for further instructions.
 4. After installation has completed, the login page appears. If the login page does not appear on its own, click the *Log On* button in the center of the web page to bring it up. If clicking on the *Log On* button does not bring up the login page, add */targets.jnlp* to the end of your IP address.

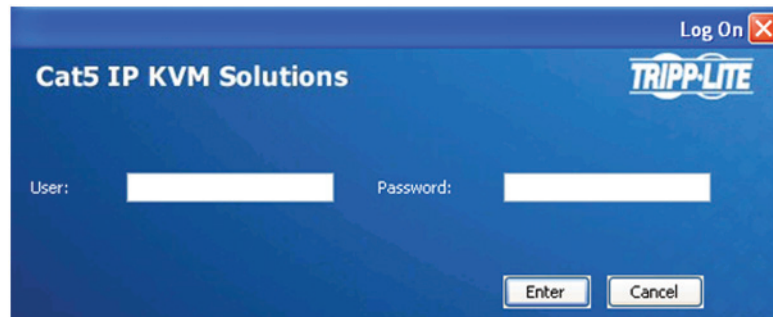

2. Web Configuration Interface



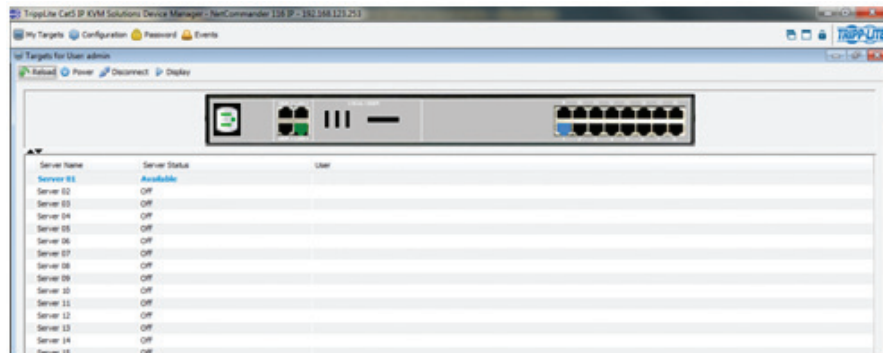



- Enter in your username and password, and press *Enter*. If this is the first time you are accessing the KVM, enter in the default username (*admin*) and password (*access*). The *My Targets* page of the Web Configuration Interface opens, showing the state of your unit, and displaying all your available Target Servers.

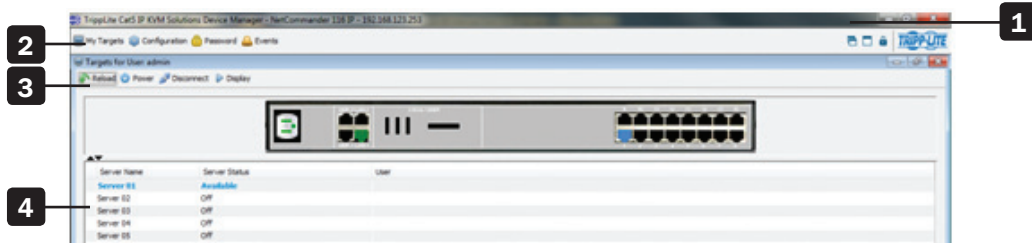

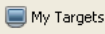
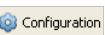
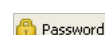
2.2 Web Configuration Interface Layout

The Web Configuration Interface contains the following main elements:



| Element | Description |
|---------------------|---|
| 1 Header Bar | <p>The <i>Header Bar</i> is at the very top of the screen, and displays the following:</p>  A general Window Icon, which you can double-click on to close the Web Configuration Interface screen, or click once on to open a menu with options for restoring, moving, sizing, minimizing, maximizing, or closing the screen. <p>To the right of the general Window Icon is displayed the product description and IP address.</p> <p>The right-hand side includes the standard browser buttons for minimizing, maximizing, and closing the screen.</p> |
| 2 Menu Bar | <p>The <i>Menu Bar</i> is directly below the <i>Header Bar</i>, and includes icons that allow you to navigate between the various sections of the Web Configuration Interface, as well as to display Web Configuration Interface screens in a Cascaded format, Log Out, and display information about the KVM.</p> <ul style="list-style-type: none">  My Targets The <i>My Targets</i> icon brings you to the page that displays the Target Servers and Serial Devices that you can access.  Configuration The <i>Configuration</i> icon brings you to the page that allows you to configure the KVM's settings and account access.  Password The <i>Password</i> icon brings you to a page that allows the logged in account to change their password.  Events The <i>Events</i> icon brings you to the page where all of the events that take place on the installation are logged.  The <i>Cascade</i> icon displays the sections of the Web Configuration Interface as cascaded pages.  The <i>Maximize</i> icon brings the Web Configuration Interface out of Cascade mode, displaying it as a maximized screen.  The <i>Log Out</i> icon closes the Web Configuration Interface screen, and pulls up the Login Screen.  The <i>About</i> icon pulls up a screen that gives you the <i>GUI Client Version</i> and <i>Firmware Version</i> of the KVM. |
| 3 Toolbar | The <i>Toolbar</i> displays icons that allow you to perform actions available to the section selected via the <i>Menu Bar</i> |
| 4 Data Pane | The <i>Data Pane</i> displays information that corresponds to the <i>Menu Bar</i> section that you selected. |



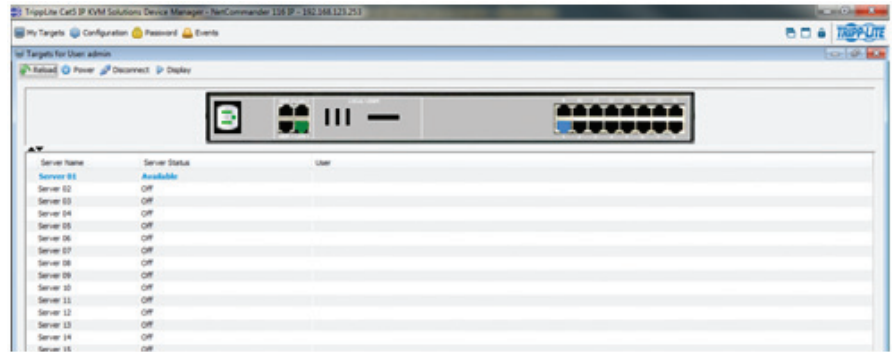

2. Web Configuration Interface

2.3 My Targets Section

The *My Targets* section of the Web Configuration Interface is the first page that is displayed upon logging into the KVM remotely. This section is where users remotely access the connected computers/servers and serial devices. When accessing the *My Targets* section, only the connected computers/servers and devices that the logged-in account has access to are displayed in the *Data Pane*. For administrators, a graphic of the KVM's back panel is displayed in between the *Toolbar* and *Data Pane*. The features of this page are described in the following section.



The following table describes the icons found in the *My Targets* section *Toolbar*.

| Icon | Description |
|---|--|
|  | In the <i>My Targets</i> section, clicking the <i>Reload</i> icon refreshes the page to display the most current information. |
|  | Clicking the <i>Power</i> icon brings up a dropdown menu of power management actions you can perform on the selected port. Note: <i>In order to perform power management actions on a port, it must be configured to match a power outlet of a power device that has been added to the KVM. (See the Power Device and Power Outlets sections of this manual for details)</i> Cycle – Choose the <i>Cycle</i> option to perform a power cycle on the computer/server connected to the selected port. Up – Choose the <i>Up</i> option to turn the power to the computer/server connected to the selected port on. Down – Choose the <i>Down</i> option to turn the power to the computer/server connected to the selected port off. |
|  | The <i>Disconnect</i> icon allows admin accounts to disconnect users from a server port. If a server port is being accessed by another account, highlighting the port and clicking the <i>Disconnect</i> icon terminates the remote session, making the Target Server available for access. |
|  | Clicking on the <i>Display</i> icon initiates a remote session, with the selected port displayed. (See the <i>Remote Session</i> section of this manual for details on managing a remote session) |

For administrators, a graphic of the KVM's back panel is displayed in between the *Toolbar* and *Data Pane*. The features of this graphic are described below.

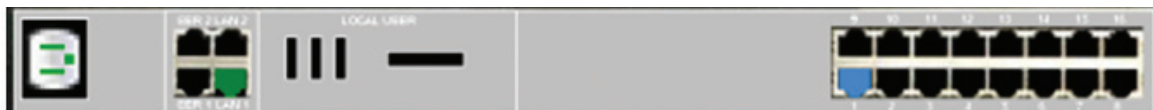

- **Power Outlet** – A Green power outlet indicates that it is working. A Red power outlet indicates that it is not working properly. A Black power outlet indicates that it is not connected.
- **Serial 1 and 2 Ports** – An Orange serial port indicates that a serial device is connected and currently being accessed by another account. A Black serial port indicates one of three things; a device is connected and available for use, a device is connected but is not functioning properly, or a device is not connected.
- **LAN 1 and 2 Ports** – A Green LAN port indicates that it is the active LAN port. The other LAN port will be Black. Only one LAN can be operational at a time. When a LAN redundancy event occurs, and LAN 2 takes over for LAN 1, the LAN 1 port will be red and LAN 2 port will be green.
- **Target Servers** – The Target Server ports will illuminate different colors to indicate their status. The different statuses are discussed in detail in the chart on the following page. A Blue port indicates that the Target Server is *Available*; a Green port indicates that a *Remote Session* or *Local Exclusive Session* is taking place on the Target Server; an Orange port indicates a *Remote Exclusive Session*; a Reddish Brown port indicates a *Blocked* server status; a Black port indicates an *Off* server status; a Red port indicates a *No Communication with Device* server status.
- ▲, ▼ - The arrow icons to the lower-left of the back panel graphic allow the logged in account to hide or unhide it. Clicking the ▲ arrow will hide the rear panel graphic; clicking the ▼ arrow will unhide it.

2. Web Configuration Interface

The following table describes the columns found in the *My Targets* section *Data Pane*.

| | |
|------------------------------------|---|
| Server Name | The <i>Server Name</i> column displays all of the Target Servers and Serial devices that are accessible to the logged in account. The <i>Server Name</i> for each port can be changed in the <i>Configuration</i> section of the Web Configuration Interface (see the <i>Switch Configuration</i> section of this manual for details). Double-click on a Target Server to initiate a remote session (See the <i>Remote Session</i> section of this manual for details on managing a remote session). |
| Server Status | The <i>Server Status</i> column shows the status of the Target Server connected to the corresponding port: Available, Off, Blocked, Local Exclusive Session, Remote Exclusive Session, Remote Session, or No Communications with Device. <ul style="list-style-type: none"> • Available – Indicates that a computer is connected to the corresponding port, and is available for use. This server status is indicated by a Blue port in the graphic of the KVM's back panel. • Off – Indicates that a computer/server is not connected to the corresponding port. This server status is indicated by a Black port in the graphic of the KVM's back panel. • Blocked – Indicates that the maximum number of simultaneous users have logged onto the KVM and are accessing connected computers. In this situation, the status of all Target Servers is <i>Blocked</i>, except those that are being accessed by other accounts. For those ports that are being accessed by other accounts, the status will appear as either <i>Remote Session</i> or <i>Remote Exclusive Session</i>. (see the <i>Sharing a Remote Session</i> and <i>Exclusive Session</i> sections in this manual for details) Target Servers that are <i>Blocked</i> cannot be accessed. A <i>Blocked</i> server status is indicated by a Reddish Brown port in the graphic of the KVM's back panel. • Local Exclusive Session – Indicates that the corresponding port is currently being accessed by a local account. This server status is indicated by a Green port in the graphic of the KVM's back panel. • Remote Exclusive Session – Indicates that an account is currently accessing the corresponding port in <i>exclusive</i> mode, preventing anyone else from connecting to it. This server status is indicated by an Orange port in the graphic of the KVM's back panel. • Remote Session – Indicates that an account is currently accessing the corresponding port in <i>share</i> mode, which allows up to 5 users to access a port at the same time. (see the <i>Sharing a Remote Session</i> and <i>Exclusive Session</i> sections in this manual for details) This server status is indicated by a Green port in the graphic of the KVM's back panel. • No Communications with Device – Indicates that a computer/server is connected to the corresponding port, but is not communicating with the KVM, and is therefore inaccessible. This server status is indicated by a Red port in the graphic of the KVM's back panel. |
| User | The <i>User</i> column displays the account that is currently accessing the corresponding port. |
| | There is an untitled column to the right of the <i>User</i> column. This column will contain a colored icon that indicates which type of SIU is connected. Green indicates that a B078-101-USB2 is connected; Light Blue indicates that a B078-101-USB-1 is connected; Orange indicates that a OSU51078, OSU51079, B078-101-PS2, or B078-101-USB is connected. |
| SIU (Server Interface Unit) | This column includes a description of the connected SIU. The B078-101-USB2 is described as a FVM SIU, the B078-101-USB-1 as a VM SIU, and the OSU51078, OSU51079, B078-101-PS2, and B078-101-USB as a SIU. |

2.4 Configuration Section

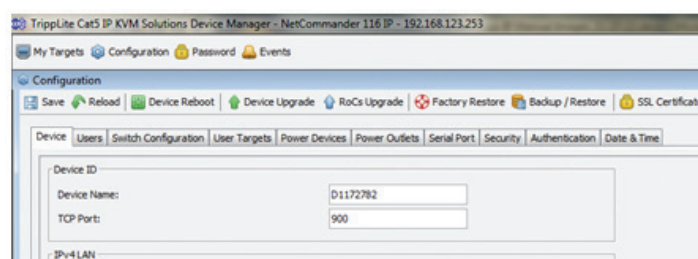

The *Configuration* section of the Web Configuration Interface is where administrator accounts can configure the KVM's settings and account access. When accessing the *Configuration* section, there are a number of sub-sections displayed as notebook tabs. Clicking on a tab will display the settings for that sub-section. The features of the *Configuration* section are described in the following pages.



The following table describes the functionality of the Web configuration toolbar buttons.

| Icon | Description |
|------|---|
| | Click the <i>Save</i> icon after making any changes in the <i>Configuration</i> section. This saves your changes. |
| | In the <i>Configuration</i> section, clicking the <i>Reload</i> icon will return a page to the most recently saved settings. For example, if you enter incorrect information into a field and want to go back to the previous value, but can't remember what the previous value of the field was, clicking the <i>Reload</i> icon will bring it back. |
| | Click the <i>Device Reboot</i> icon to reboot the KVM. |
| | Click the <i>Device Upgrade</i> to perform a firmware upgrade on the KVM (See the <i>Firmware Upgrade</i> section in this manual for details). |
| | Click the <i>SIU Upgrade</i> icon to perform a firmware upgrade on the SIUs in the installation (See the <i>Firmware Upgrade</i> section in this manual for details). |

2. Web Configuration Interface

| | |
|--|--|
|  Factory Restore | Clicking on the <i>Factory Restore</i> icon will restore the KVM's default settings, resetting all information that had been changed. The affected settings include network information, servers, switches, users, and passwords. You will be given the option of preserving the network settings when performing a <i>Factory Restore</i> . |
|  Backup / Restore | Clicking on the <i>Backup/Restore</i> icon allows an administrator to backup or restore the KVM's settings (See the <i>Backup/Restore</i> section in this manual for details). |
|  SSL Certificate | Clicking on the <i>SSL Certificate</i> icon allows an administrator to install an SSL certificate (See the <i>SSL Certificate</i> section in this manual for details). |

2.4.1 Firmware Upgrade

To perform a firmware upgrade, follow these steps:

Note: Depending on the type of firmware upgrade, the following settings may be erased: User settings, KVM switch settings, mouse and video adjustments, and RS232 settings. The network settings remain intact. For more information, refer to the firmware release notes.

1. Download the firmware upgrade file from www.tripplite.com/support.
2. Save the firmware upgrade file on the Client Computer.
3. Login to the Web Configuration Interface and navigate to the *Configuration* section. In the *Configuration* section's toolbar, click on the  *Device Upgrade* icon. The *Device Firmware Upgrade* page appears, displaying the current firmware version installed on the KVM.

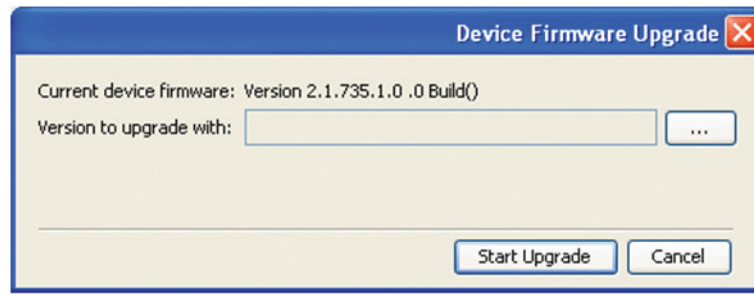

4. In the *Version to upgrade with* field, browse to and select the firmware upgrade file that you just downloaded from the Tripp Lite website.
5. Verify that the firmware upgrade file is a newer version than what is currently installed on the KVM.
6. Click the *Start Upgrade* button to begin the firmware upgrade. A progress bar will display the progress of the upgrade. An upgrade can take several minutes.

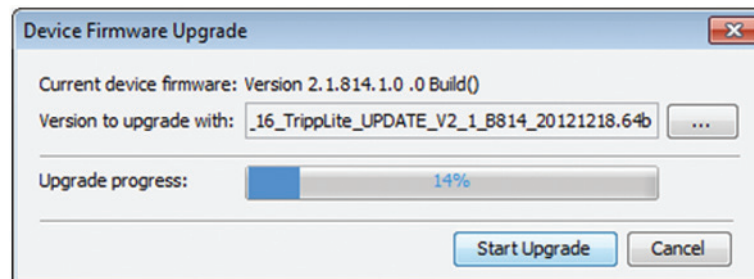

7. When the upgrade completes, click the *OK* button on the prompt that appears to close out of the Web Configuration Interface and reboot the KVM. You will be taken back to the login page.

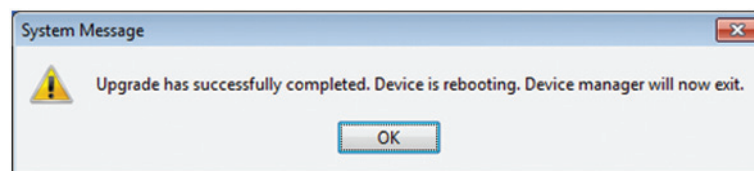

8. Click the *Log On* button to log back into the Web Configuration Interface.

2. Web Configuration Interface

In addition to the KVM firmware, you can upgrade the SIU firmware to take advantage of new features.

1. Download the firmware upgrade file from www.tripplite.com/support.
2. Save the firmware upgrade file on the Client Computer.
3. Login to the Web Configuration Interface and navigate to the *Configuration* section. In the *Configuration* section's toolbar, click on the  **SIU Upgrade** icon. The *SIU Upgrade* page appears.

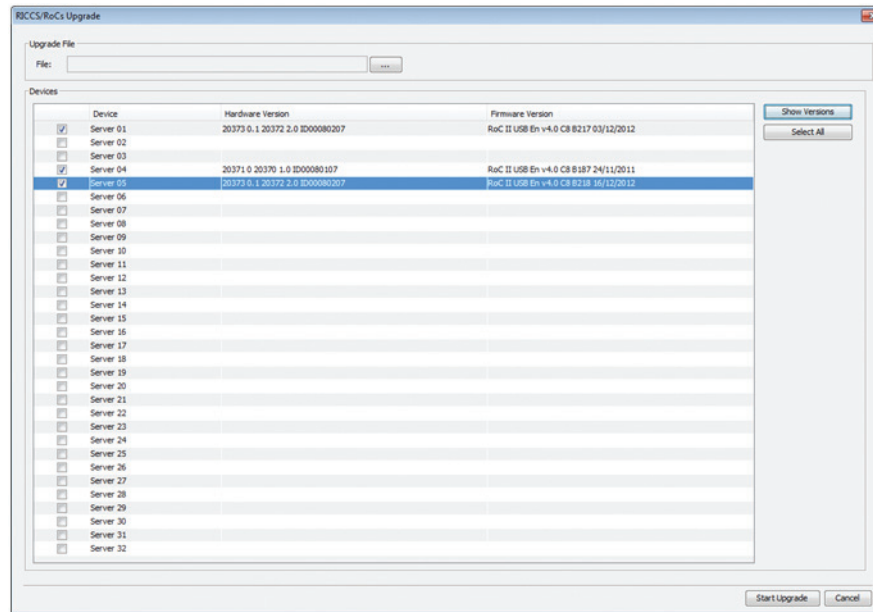

4. Select the checkboxes of the Target Servers ports that are connected to the SIU(s) that you want to upgrade. Click the *Select All* button to select all ports at the same time.
5. Click the *Show Versions* button to display the current hardware and firmware versions of the SIUs connected to the selected ports.
6. In *Upgrade File* field, browse to and select the firmware upgrade file that you just downloaded from the Tripp Lite website.
7. Verify that the firmware upgrade file is a newer version than what is currently installed on the SIU(s).
8. Click the *Start Upgrade* button to begin the firmware upgrade.
9. A prompt appears when the upgrade is complete, and asks if you want to show the new firmware versions of the SIUs.
Note: A reboot of the KVM is not necessary when upgrading the SIU firmware.

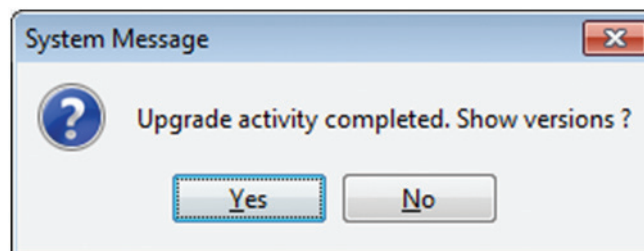

2. Web Configuration Interface

2.4.2 Backup/Restore

Using the *Backup/Restore* function in the *Configuration* sections toolbar, you can back up all configuration data and restore it at a later date.

To back up data:

1. In the toolbar, click on  *Backup / Restore* icon. The Backup/Restore Data page appears.



2. In the *Backup to file* field, click the *Browse* button to open up the *Enter file name to backup to* screen.

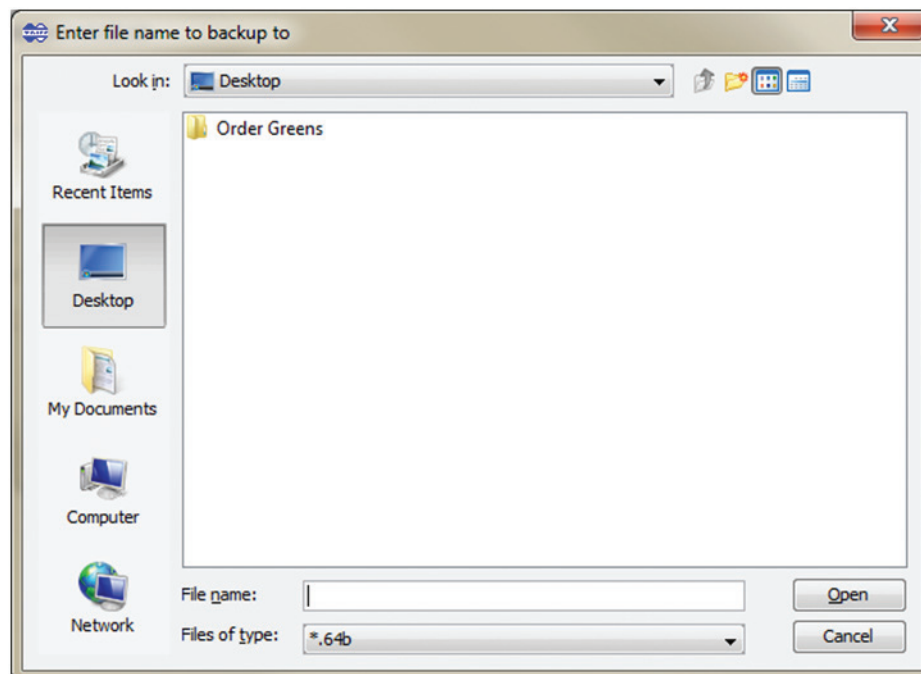

3. Navigate to the location on your computer where you want to save the backup file, and then give it an appropriate file name and click the *Open* button. Backup files are saved in the .64b format.
4. The *Backup/Restore Data* screen reappears with the newly saved location and file name populating the *Backup to file* field. Click on the *Backup* button.

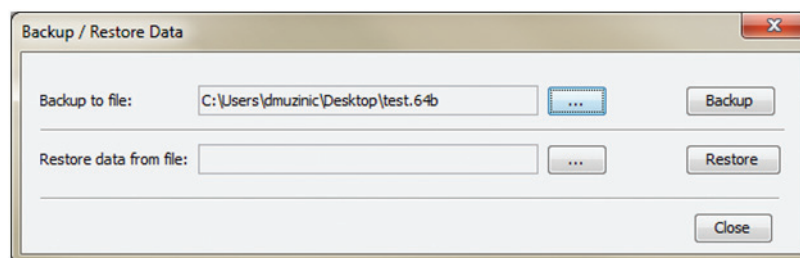

5. Upon completion of the backup, click the *Close* button to close the *Backup/Restore Data* screen.

2. Web Configuration Interface

To restore data:

1. In the toolbar, click on  Backup / Restore icon. The Backup/Restore Data page appears.

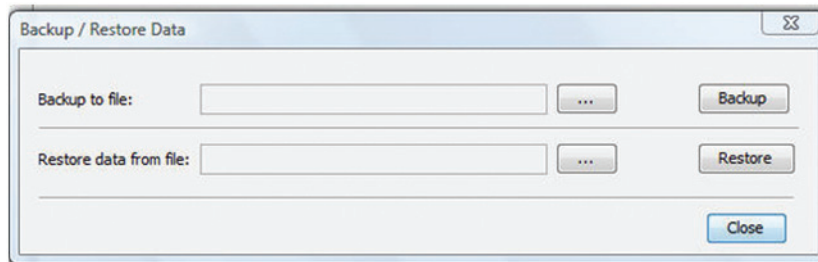

2. Click the *Browse* button next to the *Restore data from file* field, and then navigate to and select the KVM backup.
3. Click the *Restore* button to restore the KVM configuration.

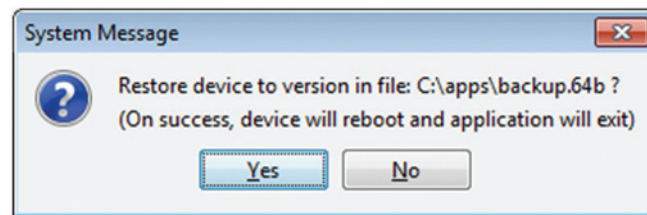

4. When complete, click the *OK* button to exit the Web Configuration Interface and perform a KVM reboot.

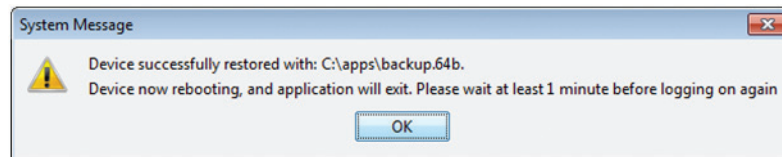

2.4.3 SSL Certificate

You can install an SSL Certificate to ensure secure transactions between the web server resident on the NetCommander and client browsers.

To install an SSL Certificate:

1. In the *Configuration* sections toolbar, click on the  SSL Certificate icon. The *SSL Certificate* screen appears.

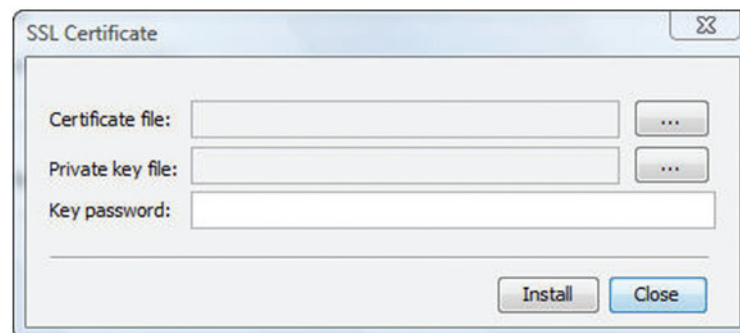

2. In the *Certificate file* field, browse to locate and select the *Cer* file you want to install.
3. In the *Private key file* field, locate and select the private key file in Microsoft PEM format.
4. In the *Key password* field, type in the password required to upload the private key file.
5. Click the *Install* button to install the SSL certificate.

2. Web Configuration Interface

- When the SSL certificate has been installed, a prompt appears to let you know the installation was successful, and that the KVM will be rebooted. Click the *OK* button to exit the Web Configuration Interface and reboot the KVM.

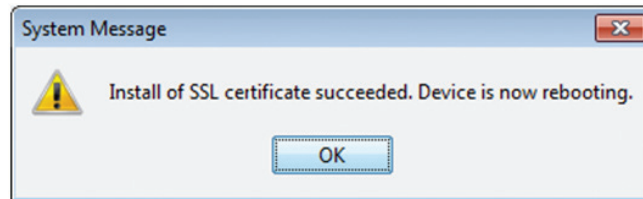

2.4.4 Device

The *Device* tab in the *Configuration* section allows administrators to configure the KVM's *Device ID*, *LAN*, and *SNMP* settings. The settings in this page are described in the following section.

Configuring the Device ID settings:

- Device Name** – The *Device Name* field allows you to assign a name to the NetCommander IP. By default, the *Device Name* consists of the letter 'D' followed by a 6-digit device number, which is printed on the label on the underside of the KVM. If the DHCP server is published in the DNS server, you can connect to the NetCommander IP system using the device name, as follows: <https://DeviceName>. Simply type in the desired *Device Name* and click the *Save* icon at the top of the page. Upon clicking *Save*, you will be prompted to reboot the KVM to finish implementation of the new *Device* settings. Click *Yes* to proceed.
- TCP Port** – The *TCP Port* refers to the port that the KVM's session data is sent through and received. This field allows you to select a port which the firewall or router security access list must enable inbound traffic through for the KVM's IP address. For client computer access from a secured LAN, the selected port should be open for communication. You can select any port from 800 to 65535. The default TCP port is 900, and the default https port is 443. Simply type in the desired *TCP Port* and click the *Save* icon at the top of the page. Upon clicking *Save*, you will be prompted to reboot the KVM to finish implementation of the new *Device* settings. Click *Yes* to proceed.

Configuring the IPv4 LAN Settings

- Enable DHCP** – By default, the *Enable DHCP* checkbox is checked, allowing for an IP address to be automatically assigned by a DHCP server. To assign a fixed IP address of your own, uncheck this checkbox.
- MAC Address** – The *MAC Address* field displays the KVM's MAC address, which can be used when locating the IP address assigned to the KVM by a DHCP server. The MAC address is also located on the bottom panel of the KVM switch.
- IP Address** – When the *Enable DHCP* checkbox is unchecked, this field becomes available for editing. Enter in an IP address appropriate for your network.
- Subnet Mask** – When the *Enable DHCP* checkbox is unchecked, this field becomes available for editing. Enter in a Subnet Mask appropriate for your network.
- Default Gateway** – When the *Enable DHCP* checkbox is unchecked, this field becomes available for editing. Enter in a Default Gateway appropriate for your network.
- When in *DHCP* mode, check the checkbox next to *DNS Server* to manually assign an address. When the *Enable DHCP* checkbox is unchecked, a *DNS Server* must be manually assigned. Enter a DNS server address appropriate for your network.
- After making any changes to the KVM's LAN settings, click on the *Save* button at the top of the screen to save them. Upon clicking *Save*, you will be prompted to reboot the KVM to finish implementation of the new *Device* settings. Click *Yes* to proceed.

Configuring the IPv6 LAN Settings

- Enable IPv6** – By default, the *Enable IPv6* checkbox is checked. To disable IPv6, uncheck this checkbox.
- Mode** – By default, the *DHCP* checkbox is checked, allowing for an IP address to be automatically assigned by a *DHCP* server. The *Mode* section also provides you the options of automatically assigning a *Stateless* address and manually assigning a *Static* address. Check the checkbox of the method you wish to use for IP address assignment.
- IPv6 Address** – When the *Static* mode checkbox is checked, this field becomes available for editing. Enter in an IP address appropriate for your network.
- Subnet Prefix Length** – When the *Static* mode checkbox is checked, this field becomes available for editing. Enter in a Subnet Prefix Length appropriate for your network.
- Default Gateway** – When the *Static* mode checkbox is checked, this field becomes available for editing. Enter in a Default Gateway appropriate for your network.

2. Web Configuration Interface

- **Obtain DNS Server Address Automatically** – When the DHCP mode checkbox is checked, this checkbox is also checked. When the Stateless or Static mode checkboxes are checked, this checkbox is deactivated, and you must manually enter a DNS Server address.
- **DNS Server** – When in *DHCP* mode, check the checkbox next to *DNS Server* to manually assign its address. When the *Stateless* or *Static* mode checkboxes are checked, the *Obtain DNS Server Address Automatically* checkbox is deactivated, and you must manually enter a *DNS Server* address. Enter a DNS Server address appropriate for your network.
- After making any changes to the KVM's LAN settings, click on the Save button at the top of the screen to save them. Upon clicking Save, you will be prompted to reboot the KVM to finish implementation of the new Device settings. Click Yes to proceed.

Configuring the SNMP settings:

This section of the Device tab allows you to configure the KVM so that notifications can be sent to a SNMP server when a LAN port fails. Upon receiving notification of the failure, LAN redundancy is enabled. **Note:** *If both LANs fail, a message cannot be sent to the SNMP server.*

- **Trap Recipient Address** – *The Trap Recipient Address* section provides three types of addresses that you can enter for the SNMP server that you want traps to be sent to: *IPv4*, *IPv6*, and *Host*. Check the checkbox of the type of address you wish to enter, and then enter in the address that corresponds to your SNMP server.
- **Community** – In this field, type in the SNMP write community string to be used for authentication of messages sent between the KVM and the SNMP server.
- After making any changes to the KVM's *SNMP* settings, click on the Save button at the top of the screen to save them. Upon clicking Save, you will be prompted to reboot the KVM to finish implementation of the new *Device* settings. Click Yes to proceed.

2.4.5 Users

The *Users* tab in the *Configuration* section allows administrators to *Add*, *Edit*, and *Delete* accounts on the KVM. Up to 256 accounts can be added, with any combination of *Administrators* and *Users*. The following section describes this page, and how to configure accounts.

There are two levels of user access:

- **Administrator** – Has unrestricted access to all windows and settings, and can change the name and password of all users.
- **User** – Can access and control Target Servers that they are given access to by an administrator. *Users* cannot access the *Configure* or *Events* sections of the Web Configuration Interface, nor can they disconnect remote sessions. When in a remote session, they are not allowed to access the power management functionality.

2. Web Configuration Interface

To add an account:

1. Click on the *Users* tab in the *Configuration* section. The *Users* page opens and displays a list of existing accounts.

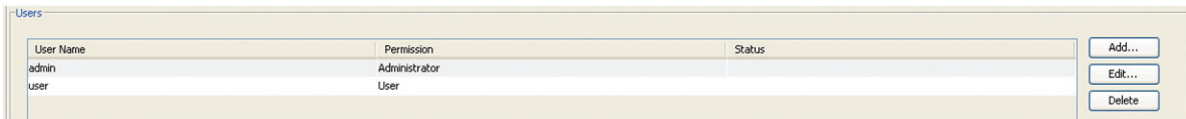

2. Click the *Add* button. The *Add User* page appears.

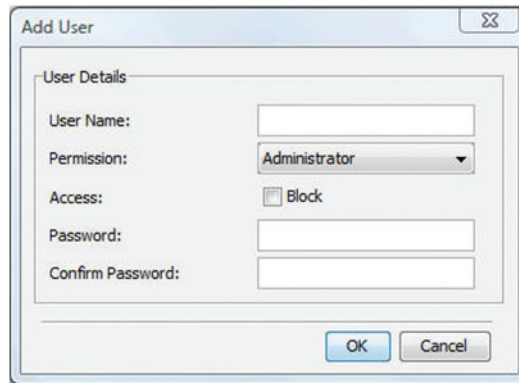

3. Type in a *User Name* and *Password*. The password must be at least six alphanumeric characters long and cannot include the user name, even if other characters are added. **Note:** Although User Names can be entered in both lowercase and uppercase, they are not case sensitive when being used to login to the KVM; therefore, do not create two users with the same name. (e.g. user1, USER1) User Name and Password must be 10 characters or less. The "special" characters **&**, **<**, **>**, and **"** cannot be used for either the user name or password. The User Name and Password parameters depend on the security level chosen (See the Security section in this manual for details).
4. In the *Confirm Password* field, retype the password.
5. In the *Permission* dropdown menu, select the permission type: *Administrator* or *User*.
6. Click *OK*. The new account is added to the list in the *Users* page.
7. Click the *Save* button at the top of the screen to save your changes.

To edit an account:

1. In the *Users* page, select an account from the list and click the *Edit* button. The *Edit User* page appears.

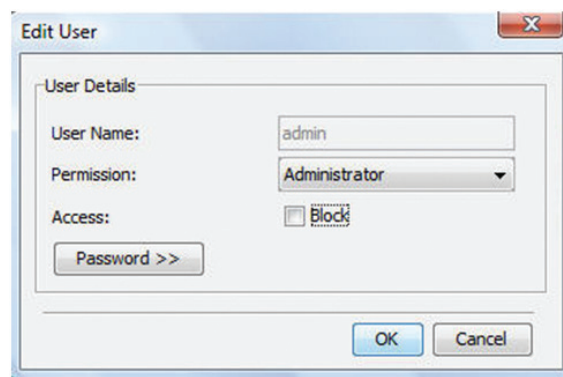

2. Change the *Permission* and/or *Access* as required. Checking the *Block* checkbox next to the *Access* field blocks an account from accessing the KVM, but keeps its information stored in the KVM. This way, if you ever want to reactivate the account, all you have to do is go back in and uncheck this box.
3. To change the password, click **Password >>**. The *Password* screen opens. In the upper textbox, type the new password; in the lower textbox, confirm the new password. **Note:** You cannot change the password of an Administrator who is currently logged on to the system.
4. Click **OK**. The *Users* page opens with the user information changed accordingly.
5. Click the *Save* button at the top of the screen to save your changes.

2. Web Configuration Interface

To delete a User:

1. In the *Users* page, select an account from the list and click the *Delete* button. The *Delete Selected User(s)* confirmation page appears.
Note: You cannot delete an Administrator who is logged onto the system.

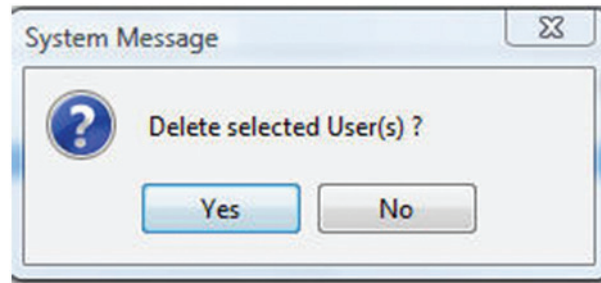

2. Click Yes to delete the selected account(s) from the KVM.
3. Click the Save button at the top of the screen to save your changes.

2.4.6 Switch Configuration

The *Switch Configuration* tab allows unique names to be assigned to each port, to help distinguish the Target Servers that are connected to them.

To edit a port name:

1. From the *Configuration* section, click on the *Switch Configuration* tab. The *Switch Configuration* page appears.

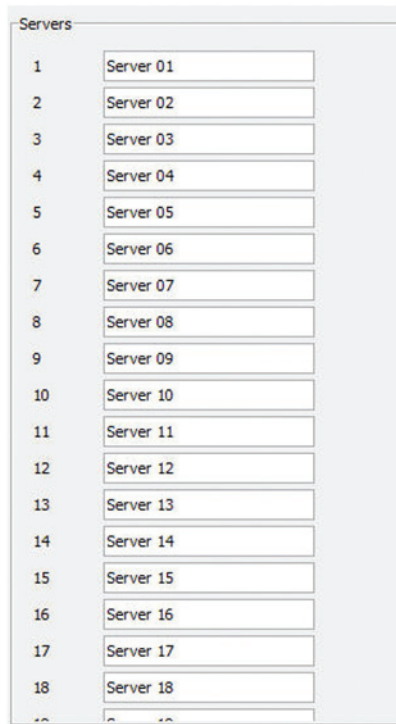

2. To change the name of a port, highlight the current server name, and type a new name.
3. Click the Save button at the top of the screen to save your changes.

2. Web Configuration Interface

2.4.7 User Targets

By default, administrators are allowed access to all servers. However, you must define the access rights of each user account to the following:

- **Target Access** – To initiate a remote session for the corresponding port.
- **Virtual media access** – To use the Virtual Media functionality when in a remote session for the corresponding port.

To configure User Targets:

1. From the *Configuration* section, select the *User Targets* tab. The *User Targets* page appears.

| Number | Name | Target Access | Virtual Media Access |
|--------|-----------|-------------------------------------|-------------------------------------|
| 1 | Server 01 | <input checked="" type="checkbox"/> | <input checked="" type="checkbox"/> |
| 2 | Server 02 | <input checked="" type="checkbox"/> | <input checked="" type="checkbox"/> |
| 3 | Server 03 | <input checked="" type="checkbox"/> | <input checked="" type="checkbox"/> |
| 4 | Server 04 | <input checked="" type="checkbox"/> | <input checked="" type="checkbox"/> |
| 5 | Server 05 | <input checked="" type="checkbox"/> | <input checked="" type="checkbox"/> |
| 6 | Server 06 | <input checked="" type="checkbox"/> | <input checked="" type="checkbox"/> |
| 7 | Server 07 | <input checked="" type="checkbox"/> | <input checked="" type="checkbox"/> |

2. From the *User* dropdown menu, select an account to configure.
3. In the *Target Access* column, check the checkboxes of all ports that you are giving the account permission to access. **Note:** You can click on the *Unselect all Target Access* button at the top of the column to clear the checkboxes of all ports. Correspondingly, you can check the *Select all Target Access* button at the top of the column to check the checkboxes of all ports.
4. In the *Virtual Media Access* column, check the checkboxes of all ports that you are giving the account Virtual Media permission for. **Note:** You can click on the *Unselect all Virtual Media Access* button at the top of the column to clear the checkboxes of all ports. Correspondingly, you can check the *Select all Virtual Media Access* button at the top of the column to check the checkboxes of all ports.
5. Click the *Save* button at the top of the screen to save your changes.

2.4.8 Power Devices

The *Power Devices* section allows for IP PDUs to be added to the KVM switch. Via the *Power Outlets* section (See the *Power Outlets* section in this manual for details), the NetCommander IP KVM ports can then be mapped to a port on one of these, allowing you to *Power Cycle* a port, or turn its power *Off/On*.

To Add a PDU:

1. From the *Configuration* section, select the *Power Devices* tab. The *Power Devices* page appears.

2. Click the *Add* button. The *Add PDU* page opens.

Add PDU

PDU Details

PDU Name:

Type: Tripp Lite PDUM^NET series 16 outlets Switched PDU

Address:

IPv4 :

IPv6 :

Host :

Outlets: 16

2. Web Configuration Interface

3. In *PDU Name*, type an appropriate name for the PDU you are adding.
4. The *Type* drop-down menu provides a list of PDUs that are supported by the NetCommander IP. Select your PDU from this list. Based on your selection, the number of PDU outlets is displayed in the *Outlets* field.
5. In the *Address* section, enter in the type of IP Address appropriate for your PDU: *IPv4*, *IPv6*, or *Host*. **Note:** When using a host name for an *IPv6* address, add the prefix **udp6:** to it. For example, a host name of **host1** should be inputted as **udp6:host1**.
6. Click *OK*. The PDU is added to the *Power Devices* page.
7. Click the *Save* button at the top of the screen to save your changes.

To Edit an existing PDU:

1. In the *Power Devices* page, select a PDU from the list and click the *Edit* button. The *Edit PDU* page appears.
2. Update the *PDU Name*, *Type*, and/or *IP* fields as required.
3. Click *OK*. The *Power Devices* page opens with the modified information.
4. Click the *Save* button at the top of the screen to save your changes.

To Delete a PDU:

1. In the *Power Devices* page, select a PDU from the list and click the *Delete* button. A prompt appears asking you to confirm the deletion of the selected PDU.

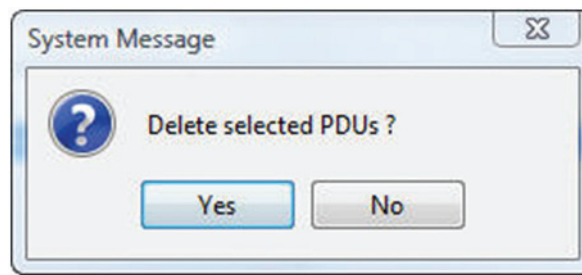

2. Click *Yes*. The *Power Devices* page opens, and the PDU no longer appear in the list.
3. Click the *Save* button at the top of the screen to save your changes.

2. Web Configuration Interface

2.4.9 Power Outlets

Once a PDU is added to the KVM via the *Power Devices* section, you need to assign a NetCommander IP Target Server port to one of the ports on a PDU to be able to *Power Cycle* it, or turn its power *Off/On*. For Target Servers with dual power supplies, you can assign multiple PDU ports to the same KVM port. In this case, power to both of the Target Server ports will be managed at the same time.

To configure the power outlets:

1. From the *Configuration* section, select the *Power Outlets* tab. The *Power Outlets* page appears.



The screenshot shows the 'Power Outlets' configuration page. At the top, there is a 'PDU Name' section with a 'Name:' label and a dropdown menu. Below this is the 'Outlets for PDU' section, which has a header 'Outlet No.:' and a 'Server Name:' label. The dropdown menu is currently empty.

2. The *Name* drop-down list contains all of the PDUs that have been added to the KVM. Select the desired PDU. The *Power Outlets* page populates according to the number of outlets on the selected PDU.

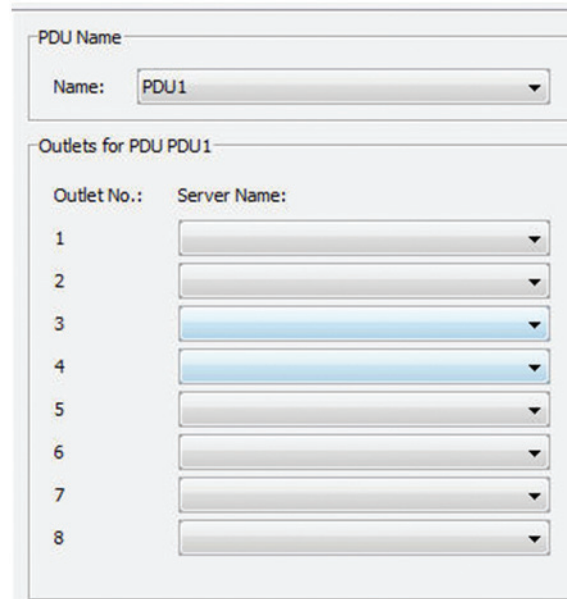

The screenshot shows the 'Power Outlets' configuration page after a PDU has been selected. The 'PDU Name' section now shows 'PDU1' in the dropdown menu. The 'Outlets for PDU PDU1' section is populated with 8 outlets, each with an 'Outlet No.:' label and a 'Server Name:' dropdown menu. The dropdown menus for outlets 3, 4, and 5 are highlighted in blue.

3. For each outlet on the PDU that has a Target Server connected to it, select from the corresponding *Server Name* dropdown list the name of the connected server.
4. Click the *Save* button at the top of the screen to save your changes.
5. Repeat these steps for each PDU that has been added to the KVM.

2. Web Configuration Interface

2.4.10 Serial Ports

The *Serial Ports* page is where you configure the settings of the serial device(s) that you have connected to the KVM. (See the *Serial Pinout* section in this manual for the pinout information.)

To configure the serial port settings:

1. From the *Configuration* section, select the *Serial Ports* tab. The *Serial Ports* page appears.

The screenshot shows two configuration panels for serial ports. Each panel includes a text input for 'Device Name', and dropdown menus for 'Baud Rate', 'Parity', 'Data Bits', and 'Stop Bits'. The values shown are: Serial Port 1 (Telnet 01, 9600, NONE, 8, 1) and Serial Port 2 (Telnet 02, 9600, NONE, 8, 1).

2. For each serial device connected, enter an appropriate *Device Name*, and then set the *Baud Rate*, *Parity*, *Data Bits* and *Stop Bits* settings accordingly.
3. Click the *Save* button at the top of the screen to save your changes.

2.4.11 Security

The *Security* section allows you to configure the security features of the KVM, such as *Account Blocking*, *Password Policy*, *Idle Timeout*, and *Serial Terminal Policy*.

To configure the security settings:

1. From the *Configuration* section, select the *Security* tab. The *Security* page appears.

The screenshot shows four configuration sections: 'Account Blocking' with input fields for 'Block after' (5) and 'attempts within (hr:min)' (0:3), and radio buttons for 'Block account' (selected: 'for period (hr:min): 0:30', unselected: 'forever'); 'Password Policy' with checkboxes for 'High security password policy' and 'Enable OSD password'; 'Idle Timeout' with a dropdown for 'Disconnect after' (10) and the text 'minutes of inactivity'; and 'Serial Terminal Policy' with a checkbox for 'Enable direct SSH connection' and input fields for 'Serial 1 TCP port' (4001) and 'Serial 2 TCP port' (4002).

2. Web Configuration Interface

2. In the *Account Blocking* section:
 - In the *Block after* field, enter in the number of unsuccessful login attempts that will be allowed in a given time period. This time period is set in the *attempts within (hr:min)* field. Enter into this field the time in hours and minutes.
 - In the *Block account* field, you can select the length of time that an account will be blocked for if it exceeds the number of unsuccessful login attempts.
 - Check the *for period (hr:min)* checkbox to block the account for a specified period of time. This time period is set in the hours and minutes fields to the right of the *for period (hr:min)* checkbox.
 - Check the *forever* checkbox to block the account indefinitely.
3. In the *Password Policy* section:
 - Select the *High security password policy* checkbox to enable the high security password policy, or leave it unchecked to enable the standard security policy to apply. Both security policies prohibit the use of the username being included in the password, and have a maximum character limit of 10. The standard security policy requires only that the password contain at least six characters. The high security policy requires that the password contain at least eight characters, and that it contain one number, one upper-case letter, and one of the following special characters: `!, @, #, $, %, ^, *, (), -, +, =, [], ', :, ;, ?, /, or {}`
 - Check the *Enable OSD password* checkbox to require that a username and password be entered for local user access to the OSD. By default, a password is not required to access the KVM via the local console. Accounts created in the Web Configuration Interface are used for both local and remote access.
4. There is only one field in the *Idle Timeout* portion of the *Security* page: *Disconnect after*. In this field, select the amount of time that an account can be idle before it is automatically disconnected from the system. Select *No Timeout* to disable this feature.
5. The *Serial Terminal Policy* portion of the *Security* page allows you to enable access to the connected serial devices via your own SSH client (e.g. PuTTY, SecureCRT, etc.). By default, this is disabled, so that an account must open the Web Configuration Interface and double-click on the serial ports in the *My Targets* screen list to access them via the NetCommander IP's internal SSH client. To enable direct SSH connection, check the *Enable direct SSH connection* checkbox and enter in the desired TCP port numbers for serial ports 1 and 2 (by default, these are set to 4001 and 4002). You can then access the connected serial devices using your own SSH client by providing 1) the IP address of the NetCommander IP, 2) the TCP port number for the desired serial device, and 3) your KVM username and password.
6. After changing any settings in the *Security* page, click the *Save* button at the top of the page to save your changes.
7. Upon clicking *Save*, you will be prompted to reboot the KVM to finish implementation of the new *Security* settings. Click *Yes* to proceed.

2. Web Configuration Interface

2.4.12 Authentication

The *Authentication* page allows you to set up remote authentication via RADIUS and/or LDAP/S server. From the *Configuration* section, select the *Authentication* tab to open this page.

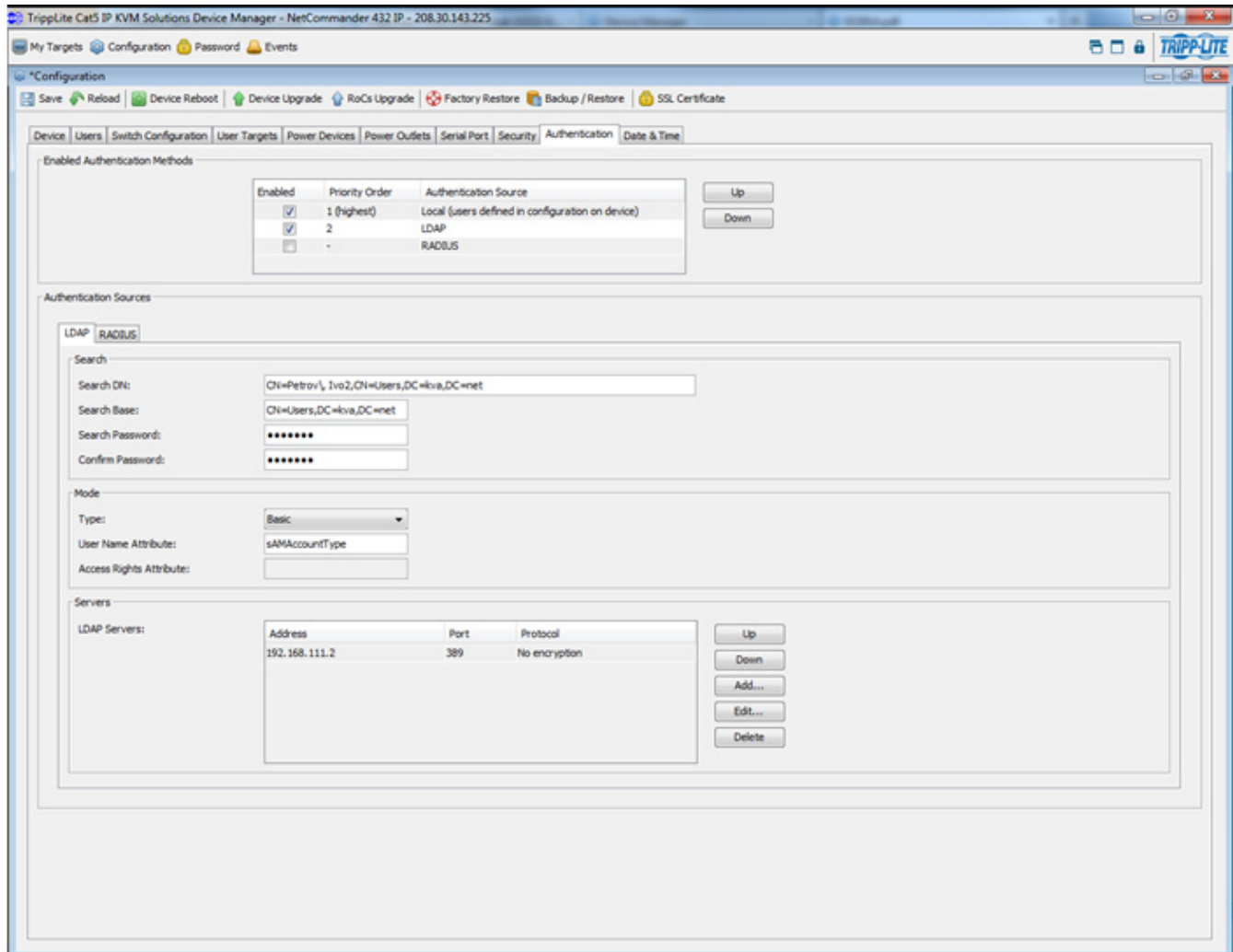

Enable Authentication Methods – The section at the top of the *Authentication* page determines which types of authentication are enabled, and what priority they take when authenticating a user. For example, when all three methods are enabled in the order of *Local*, *LDAP*, and *RADIUS*, the KVM's local user accounts will be checked first during authentication, followed by the LDAP server, and finally the RADIUS server. By default, *Local* authentication is permanently enabled and given the highest priority. To enable or disable *LDAP* and/or *RADIUS* authentication, simply check or uncheck the corresponding checkbox. To switch the priority of *LDAP* and *RADIUS* authentication, highlight the desired option by clicking on it, and then click on the *Up* and *Down* buttons to move it up and down in the list.

LDAP/S Authentication Settings – Once enabled in the *Enabled Authentications Methods* section just described, LDAP/S authentication is set up using the fields in the *Authentication Sources* section. To setup LDAP/S authentication, make sure that the *LDAP* tab in the *Authentication Sources* section is selected, and then follow the instructions below.

Servers – At the bottom of the page, the *Servers* section allows you to add LDAP/S servers to the KVM. As with the authentication methods in the *Enabled Authentication Methods* section at the top of the page, LDAP/S servers can be listed according to priority. The first server in the list will be the first one accessed by the KVM during authentication, followed by the second server, etc.. To avoid performance issues during the authentication process, it is recommended that you add no more than three LDAP/S servers.

2. Web Configuration Interface

- To add an LDAP/S server to the list, click on the *Add* button to bring up the *Add LDAP Server* screen.

- Enter the *IPv4*, *IPv6*, or *Host* address for your LDAP/S server in the corresponding field.
- Select the *Port* number that is used by the server. The default port number is 389 for LDAP/TLS servers and 636 for LDAPS servers.
- Select from one of three encryption methods to use: *No encryption*, *SSL*, or *TLS extension*.
- Click the *OK* button to add the server to the list.
- Servers can be edited or deleted by highlighting them in the list and clicking on *Edit* or *Delete*. They can be re-ordered according to their priority by highlighting them and clicking on *Up* or *Down* to move them in the list.

Search – The *Search* section is where you set the account DN that is used to query the LDAP/S server, and where in the directory to search during authentication. Reference the following screenshots and descriptions of the *Search* fields when adding this information.

The screenshot shows the 'LDAP' configuration page in the web interface. The 'Search' section has the following fields:

- Search DN: `CN=Matt Jones,CN=Users,DC=kva,DC=net` (highlighted with a red box)
- Search Base: `CN=Users,DC=kva,DC=net`
- Search Password: `****`
- Confirm Password: `****`

The 'Mode' section has:

- Type: `Basic`
- User Name Attribute: `sAMAccountType`
- Access Rights Attribute: (empty)

The 'Servers' section shows a table of LDAP servers:

| Address | Port | Protocol | Up | Down |
|---------------|------|---------------|----|------|
| 192.168.111.2 | 389 | No encryption | | |

The bottom part of the screenshot shows the Active Directory Explorer window. The path is `CN=Matt Jones,CN=Users,DC=kva,DC=net,AD as ivo [pancakes.kva.net]`. The attribute list shows the following attributes for the user:

| Attribute | Syntax | Count | Value(s) |
|-------------------|-----------------|-------|--------------------------------------|
| accountExpires | Integer8 | 1 | 0x7FFFFFFF |
| badPasswordTime | Integer8 | 1 | 0x0 |
| badPwdCount | Integer | 1 | 0 |
| cn | DirectoryString | 1 | Matt Jones |
| codePage | Integer | 1 | 0 |
| countryCode | Integer | 1 | 0 |
| displayName | DirectoryString | 1 | Matt Jones |
| distinguishedName | DN | 1 | CN=Matt Jones,CN=Users,DC=kva,DC=net |
| givenName | DirectoryString | 1 | Matt |

- Search DN** – The *Search DN* field should be populated with the value of the Distinguished Name attribute for the user account that is being used to query the Active Directory.

2. Web Configuration Interface

- **Search Base** – The *Search Base* field should be populated with the location in the Active Directory in which the search is taking place.
- **Search Password** – The *Search Password* field should be populated with the password for the user account that is being used to query the Active Directory.
- **Confirm Password** – Re-enter the password into this field to confirm that you have entered it correctly.

Mode – The *Mode* section allows you to define the *User Name* and *Access Rights* attributes that are used during authentication, as well as how access rights get assigned to an authenticated account. Reference the following screenshots and descriptions of the *Mode* fields when adding this information.

- **Type** – The *Type* drop-down menu allows you to choose between three methods of assigning access rights to authenticated accounts: *Basic*, *User*, and *Group*.
 - o *Basic* – When selected, this method authenticates accounts that log in, and gives each account full access rights to the KVM switch.
 - o *User* – When selected, this method authenticates accounts that log in, and gives them access rights to the KVM switch based on those that are assigned to them via a dedicated *Access Rights* attribute.
 - o *Group* – When selected, this method authenticates accounts that log in, and gives them access rights to the KVM switch based on which *Group* they belong to. Access rights for *Groups* are based on those that are assigned to them via a dedicated *Access Rights* attribute.

The screenshot shows the 'RADIUS' configuration page for 'Cat5 IP KVM Solutions'. The 'LDAP' tab is active, showing search settings. A 'Log On' dialog box is overlaid on top, with the 'User' field containing 'jadams' and the 'Password' field masked with dots. Below the dialog, the 'Mode' section shows 'Type' set to 'Basic' and 'User Name Attribute' set to 'sAMAccountName'. At the bottom, a table displays LDAP search results for the user 'John Adams', with 'sAMAccountName' highlighted in green and its value 'jadams' shown in the 'Value(s)' column.

| Attribute | Syntax | Count | Value(s) |
|----------------------|----------------------|-------|--|
| accountExpires | Integer8 | 1 | 0x7FFFFFFF |
| badPasswordTime | Integer8 | 1 | 0x0 |
| badPwdCount | Integer | 1 | 0 |
| cn | DirectoryString | 1 | John Adams |
| codePage | Integer | 1 | 0 |
| countryCode | Integer | 1 | 0 |
| displayName | DirectoryString | 1 | John Adams |
| distinguishedName | DN | 1 | CN=John Adams,CN=Users,DC=kva,DC=net |
| givenName | DirectoryString | 1 | John |
| instanceType | Integer | 1 | 4 |
| lastLogoff | Integer8 | 1 | 0x0 |
| lastLogon | Integer8 | 1 | 0x0 |
| logonCount | Integer | 1 | 0 |
| name | DirectoryString | 1 | John Adams |
| ntSecurityDescriptor | NTSecurityDescriptor | 1 | D:AI(A;;CCDCLCSWRPWPDTLOCRSDRCWDWO;;;DA)XA |
| objectCategory | DN | 1 | CN=Person,CN=Schema,CN=Configuration,DC=kva,DC=net |
| objectClass | OID | 4 | top;person;organizationalPerson;user |
| objectGUID | OctetString | 1 | {07CA26BB-EA4E-406F-84B2-46AF0978688} |
| objectSid | Sid | 1 | S-1-5-21-943964784-2670248329-3150175574-1169 |
| primaryGroupID | Integer | 1 | 513 |
| pwdLastSet | Integer8 | 1 | 11/11/2013 11:44:37 AM |
| sAMAccountName | DirectoryString | 1 | jadams |
| sAMAccountType | Integer | 1 | 805306368 |

- **User Name Attribute** – The *User Name Attribute* field should be populated with the name of the attribute that contains the user login name for an account. **Note:** The name that an account uses to log into the KVM switch cannot contain any spaces. If the user login name contains a space, authentication will not be successful.
- **Access Rights Attribute** – The *Access Rights Attribute* field is only needed when *User* or *Group* is selected in the *Type* drop-down menu. It should be populated with the name of a directory attribute that contains the *Access Rights Permission String* (See the *Access Rights Permission String* section for details), which determines what rights a *User* or *Group* has to the KVM. Any directory attribute that can contain strings may be used to hold the *Access Rights Permission String*, so you can either re-purpose an existing attribute or create a brand new one.

2. Web Configuration Interface

Access Rights Permission String – In order for access rights to be assigned in *User* or *Group* authentication mode, a permission string must be entered into the directory attribute that is assigned to each *User* or *Group*. The name of this attribute must be entered into the *Access Rights Attribute* field in the *Mode* section of the *Authentication* page. See below for an explanation of how the permission string needs to be formatted.

Access Category – An *Access Category* is an entry in the permission string that refers to a particular access right to the KVM switch. The available *Access Categories* are listed below.

Note:

1. *Access Categories* are case sensitive.
2. *Access rights* must be assigned for each *Access Category*, regardless of whether *User* or *Admin* is assigned as the *kvmrole*.
 - **kvmdevice** – Refers to the Device Name of a NetCommander IP Multi-User KVM switch. The Device Name of a KVM can be found in the *Device* tab of the *Configuration* section of the web configuration interface (See the *Device* section in this manual for details). If **kvmdevice** is not referenced in the permission string, then access will be allowed to all KVM switches.
 - **kvmrole** – Refers to the type of account, and can be either *Admin* or *User* (See the *Users* section of this manual for details on these account types).
 - **kvmports** – Refers to the list of ports that an account is allowed to access. Ports are separated in the permission string by a comma. An asterisk (*) can be used to indicate access to all ports.
 - **vm_ports** – Refers to the list of virtual media ports that an account is allowed to access. Ports are separated in the permission string by a comma. An asterisk (*) can be used to indicate access to all ports.
 - **kvmtelports** – Refers to the list of serial ports that an account is allowed to access. Ports are separated in the permission string by a comma. An asterisk (*) can be used to indicate access to all ports.

Sample Permission String

```
kvmdevice:D1144567,kvmrole:user,kvmports:1,2,5,vm_ports:1,2,kvmtelports:*
```

The permission string above assigns a *User* or *Group* with access to the KVM with Device Name D1144567. The account is given *User* permissions and has access to ports 1, 2, and 5 on the KVM, can access virtual media on ports 1 and 2, and can access all serial ports.

RADIUS Authentication Settings – Once enabled in the *Enabled Authentication Methods* section, RADIUS authentication is set up using the fields in the *Authentication Sources* section. To setup RADIUS authentication, make sure that the *RADIUS* tab in the *Authentication Sources* section is selected, and then follow the instructions below. **Note:** For RADIUS authentication to work properly, a *Tripp Lite dictionary* must be installed on the RADIUS server. The dictionary should be present in the latest dictionaries supplied by FreeRADIUS, or can be manually downloaded at www.triplite.com/support.

Servers – At the bottom of the page, the *Servers* section allows you to add RADIUS servers to the KVM. As with the authentication methods in the *Enabled Authentication Methods* section at the top of the page, RADIUS servers can be listed according to priority. The first server in the list will be the first one accessed by the KVM during authentication, followed by the second server, etc. To avoid performance issues during the authentication process, it is recommended that you add no more than three RADIUS servers.

- To add a RADIUS server to the list, click on the *Add* button to bring up the *Add RADIUS Server* screen.

The screenshot shows a dialog box titled "Add RADIUS Server". It has a standard Windows-style title bar with a close button (X) in the top right corner. The main area contains the following fields and controls:

- Address:** A group of three radio buttons: "IPv4" (selected), "IPv6", and "Host". To the right of these buttons are three input fields: a dotted box for IPv4, an empty box for IPv6, and an empty box for Host.
- Port:** An input field containing the number "1812".
- Accounting Port:** An input field containing the number "1813".
- Secret:** An empty input field.
- Confirm Secret:** An empty input field.

At the bottom right of the dialog, there are two buttons: "OK" and "Cancel".

- Enter the *IPv4*, *IPv6*, or *Host* address for your RADIUS server in the corresponding field.

Note: The *Host name* should only be used for *IPv4* RADIUS servers. For *IPv6* RADIUS servers, the *IPv6* address should be used instead of a *Host name*.
- Select the authentication *Port* number and *Accounting Port* number to be assigned to the server. The default authentication port number is 1812, and the default accounting port number is 1813.

2. Web Configuration Interface

- Enter and re-enter a shared secret according to the one specified in the RADIUS server.
- Click the *OK* button to add the server to the list.
- Servers can be edited or deleted by highlighting them in the list and clicking on *Edit* or *Delete*. They can be re-ordered according to their priority by highlighting them and clicking on *Up* or *Down* to move them in the list.

Global – The *Global* section allows you to define the *Default Realm* of the RADIUS server, and to enable/disable *Accounting Support*.

- **Default Realm** – Enter in the *Default Realm* for the RADIUS server here.
- **Enable Accounting Support** – Check this checkbox to enable *Accounting Support*, or leave it unchecked to disable it. When enabled, *Accounting Support* will generate *Start* and *Stop* accounting events that keep track of when a user accesses a KVM port, and when it disconnects from it.

RADIUS Access Rights – RADIUS access rights are assigned to accounts by adding a *TrippLite-KVM-ACL* field into the user account definition in the user's file (on FreeRADIUS), or on user settings (under Active Directory), and populating it with a permission string. The permission string format will be the same as that described in the *Access Rights Permission String* section of this manual. The only difference is that it will need to contain the prefix *TrippLite-KVM-ACL=*, which designates the property used for it under the Tripp Lite Dictionary.

For example, to give an account Admin access to all KVM ports on all KVMs, the following should be added to the user's file entry on FreeRADIUS.

```
account          ClearText-Password=[enter account password here]
                  Framed-Protocol=PPP
                  Framed-IP-Address=[enter RADIUS IP here]
                  Framed-IP-Netmask=255.255.255.0
                  Framed=MTU=1500
                  TrippLite-KVM-ACL=kvmrole:admin,kvmports:*
```

2.4.13 Date & Time

This section describes how to configure the system date and time. The system date and time are used when recording log events (see the *Events* section in this manual for details).

To configure the date and time:

From the *Configuration* section, select the *Date & Time* tab. The *Date & Time* page appears.

The screenshot shows a web interface for configuring the system date and time. It is divided into two sections: 'Date' and 'Time'. The 'Date' section has three input fields: 'Day' with the value '26', 'Month' with the value '6', and 'Year' with the value '2003'. The 'Time' section has three input fields: 'Hour' with the value '1', 'Minute' with the value '26', and 'Second' with the value '17'.

1. In the *Date* fields, enter in the current *Day*, *Month* and *Year*.
2. In the *Time* fields, enter in the current *Hour*, *Minute* and *Second*.
3. Click the *Save* button at the top of the page to save your changes.

2.5 Password Section

The *Password* section of the Web Configuration Interface provides a convenient way for an account to change their password.

To change the password:

1. Click on the  *Password* icon in the menu bar of the Web Configuration Interface. The *Change Password* page is displayed.

The screenshot shows the 'Change Password' page. At the top, there is a blue header with the title 'Change Password' and a 'Save' button. Below the header, there are three input fields: 'User Name' with the value 'admin', 'New Password' (empty), and 'Confirm Password' (empty).

2. Web Configuration Interface

- In the *New Password* field, type in a new password, according to the *Password Policy* set in the *Security* page of the *Configuration* section (see the *Security* section in this manual for details).
- In the *Confirm Password*, retype the new password.
- Click  **Save**. The new password is saved in the system.

2.6 Events Section

The *Events* section of the Web Configuration Interface allows administrator accounts to view a log of events that take place on the installation. In the *Events* page, you can view the log, refresh its information, clear it, and save it to a .csv file, which can be converted to Excel.

To view the Events Log:

- Click on the  **Events** icon in the menu bar of the Web Configuration Interface. The *Events* page appears, with a log of all system events displayed.

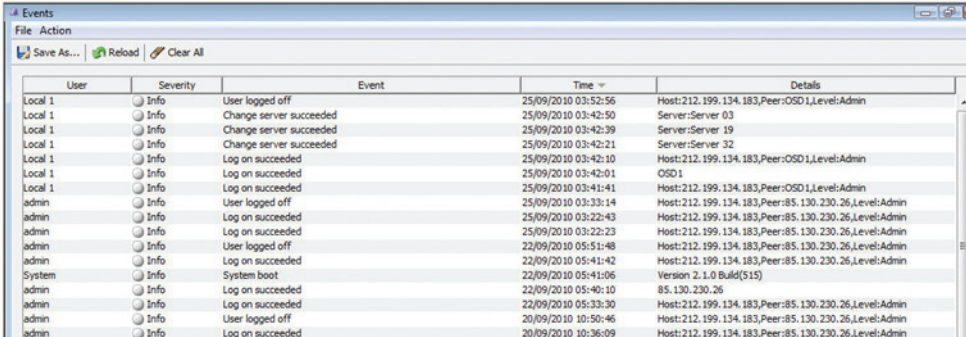

| User | Severity | Event | Time | Details |
|---------|----------|-------------------------|---------------------|---|
| Local 1 | Info | User logged off | 25/09/2010 03:52:56 | Host:212.199.134.183,Peer:OSD1,Level:Admin |
| Local 1 | Info | Change server succeeded | 25/09/2010 03:42:50 | Server:Server 03 |
| Local 1 | Info | Change server succeeded | 25/09/2010 03:42:39 | Server:Server 19 |
| Local 1 | Info | Change server succeeded | 25/09/2010 03:42:21 | Server:Server 32 |
| Local 1 | Info | Log on succeeded | 25/09/2010 03:42:10 | Host:212.199.134.183,Peer:OSD1,Level:Admin |
| Local 1 | Info | Log on succeeded | 25/09/2010 03:42:01 | OSD1 |
| Local 1 | Info | Log on succeeded | 25/09/2010 03:41:41 | Host:212.199.134.183,Peer:OSD1,Level:Admin |
| admin | Info | User logged off | 25/09/2010 03:33:14 | Host:212.199.134.183,Peer:85.130.230.26,Level:Admin |
| admin | Info | Log on succeeded | 25/09/2010 03:22:43 | Host:212.199.134.183,Peer:85.130.230.26,Level:Admin |
| admin | Info | Log on succeeded | 25/09/2010 03:22:23 | Host:212.199.134.183,Peer:85.130.230.26,Level:Admin |
| admin | Info | User logged off | 22/09/2010 05:51:48 | Host:212.199.134.183,Peer:85.130.230.26,Level:Admin |
| admin | Info | Log on succeeded | 22/09/2010 05:41:42 | Host:212.199.134.183,Peer:85.130.230.26,Level:Admin |
| System | Info | System boot | 22/09/2010 05:41:06 | Version 2.1.0 Build(515) |
| admin | Info | Log on succeeded | 22/09/2010 05:40:10 | 85.130.230.26 |
| admin | Info | Log on succeeded | 22/09/2010 05:33:30 | Host:212.199.134.183,Peer:85.130.230.26,Level:Admin |
| admin | Info | User logged off | 20/09/2010 10:50:46 | Host:212.199.134.183,Peer:85.130.230.26,Level:Admin |
| admin | Info | Log on succeeded | 20/09/2010 10:36:09 | Host:212.199.134.183,Peer:85.130.230.26,Level:Admin |

To reload the Events Log:

- With the *Events* page open, click the  **Reload** icon in the toolbar. The list of events on the page is refreshed to show the most current information.

To clear the Events Log:

- With the *Events* page open, click the  **Clear All** icon in the toolbar. A prompt appears asking you to confirm the action.

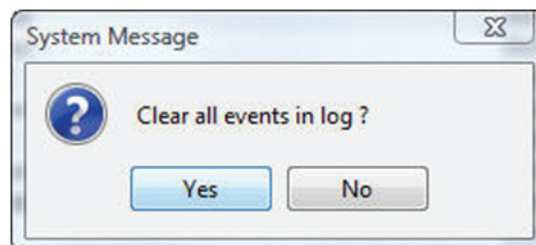

- Click the Yes button. The Events Log is permanently cleared.

To save the Events Log:

- With the *Events* page open, click the  **Save As...** icon in the toolbar. The Save As window appears.
- Type an appropriate name for the file, and select a location on your computer to save it in. Click the Save button to save the file.
Note: The file will automatically be save as a .csv file, which can be opened in Excel.

3. Conducting a Remote Session

A remote session allows accounts IP access to computer/servers and serial devices connected to the KVM. In a remote session, accounts can access computers/servers, power cycle or turn power to a Target Server Off/On, virtually mount an .iso file, and configure the remote session settings. The sections that follow explain the features of a remote session, and how to use them.

3.1 Starting a Remote Session

To start a remote session:

1. Open the Web Configuration Interface, and click on the  My Targets icon in the menu bar. The *My Targets* screen appears, displaying only those ports that the logged-in account is permitted to use. For administrator accounts, a graphic of the KVM's back panel is displayed in between the *Toolbar* and *Data Pane*.



2. A remote session can be initiated in one of four ways:
 - Select a port from the *Data Pane* of the *My Targets* screen, and click on the *Display* icon in the toolbar.
 - Select a port from the *Data Pane* of the *My Targets* screen, and press the [Enter] key.
 - Double-click on a port in the *Data Pane* of the *My Targets* screen.
 - **Administrator's Only** – Double-click on a port in the graphic of the KVM's back-panel.

Note: A *Target Server* with a Remote Exclusive Session or Local Exclusive Session status is being accessed by another account in Exclusive Mode (see the Exclusive Session section in this manual for details), and cannot be accessed. A *Target Server* with a Remote Session status is being accessed by another account in Share Mode, which allows for up to 5 users to access the port at the same time (see the Sharing a Remote Session section in this manual for details).

3. Upon initiating a remote session in one of these four ways, the screen of the selected Target Server appears inside a remote console window with the remote session toolbar displayed.

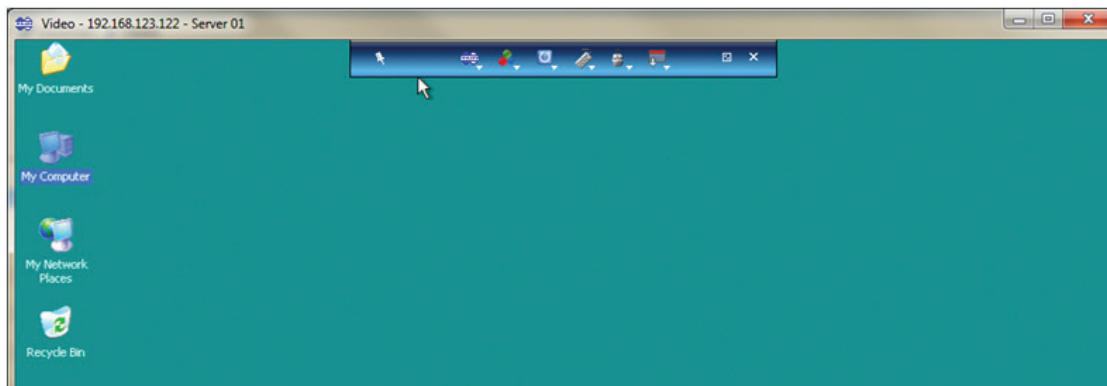

3. Conducting a Remote Session

3.2 Remote Session Toolbar



The NetCommander IP provides a toolbar that allows a remote session to be manipulated. The features on the toolbar allow you to toggle between accessible ports, adjust the video settings of the remote session, align the local and remote mouse pointers, etc.. When a remote session is initiated, the toolbar is displayed briefly in the top-center of the screen, and then collapses to display only a thin bar. To expand the toolbar, simply move the mouse pointer over the blue bar at the top-center of the screen. The following sections describe the features available in the remote session toolbar, and how they are used.

3.2.1 Pin Toolbar

 – Clicking on the *Pin Toolbar* icon will toggle between displaying the toolbar constantly and allowing it to disappear after a few seconds. By default, it disappears after a few seconds.

3.2.2 Session

 – Clicking on the *Session* icon will display a drop-down list of four options; *Mount ISO*, *Unmount ISO*, *Session Profile*, and *About*.

- **Mount ISO** – The *Mount ISO* feature allows you to mount an ISO file to the Target Server as virtual media.

Note:

1. *Virtual Media data transfer rates up to 12Mbps are supported. To achieve data transfer rates up to 12Mbps, a B078-101-USB2 must be used.*
2. *A B078-101-USB-1 can be used to provide Virtual Media support, but only at speeds up to 1Mbps. B078-101-USB and B078-101-PS2 SIUs are not compatible with Virtual Media.*
3. *The ISO file that you are mounting must be located in a Shared Folder of a Samba or NFS file server which is on the same network that the NetCommander IP is connected to.*

To mount the ISO as virtual media:

1. Click on the  icon in the remote session toolbar, and choose the *Mount ISO* option. The *Mount ISO* window appears.

A dialog box titled "Mount ISO as Virtual Media". It has three main sections: "ISO File Selection", "User Name and Password", and "Mounted ISO".
- "ISO File Selection":
 - Share Name: \\ShareServer\share
 - ISO Path: \soft\iso\generic.iso
 - Source: Samba (Microsoft Windows) and NFS (Unix/Linux)
 - Example (Windows): \\hostname\sharedir\file.iso >> Share Name: \\hostname\sharedir, ISO Path: \file.iso
- "User Name and Password":
 - User Name (optional):
 - Password (optional):
- "Mounted ISO":
 - Current Mounted ISO Path: Not mounted
 - Refresh button
At the bottom are "Mount" and "Close" buttons.

2. In the *Share Name*, type in the share name of the ISO file from your Samba or NFS file server. For example, if the desired ISO file has the path \\hostname\sharedir\file.iso, the Share Name that you should type is: \\hostname\sharedir.
3. In the *ISO Path* field, type the direct path to the ISO file. In the example of the previous step, the ISO Path is \file.iso.
4. Select one of the following supported file sharing methods:
 - **Samba (Microsoft Windows)**
 - **NFS (Unix/Linux)**
5. For secured file sharing type in a *User Name* and *Password*.
6. Click the *Mount* button. The ISO file is mounted onto the server.

3. Conducting a Remote Session

- **Unmount ISO** – The *Unmount ISO* feature disconnects an ISO virtual media file that has already been mounted.

To unmount an ISO file:

1. Click on the  icon in the remote session toolbar, and choose the *Unmount ISO* option. A prompt appears asking you to confirm the action.

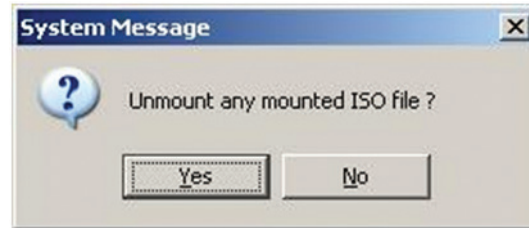

2. Click Yes. The ISO virtual media file is unmounted from the remote server.

- **Session Profile** – The *Session Profile* feature allows you to set a few basic parameters for the remote session; *Local Mouse Pointer* image, *On Connect* settings, and *Exclusivity*.

To set the session profile:

1. Click on the  icon in the remote session toolbar, and choose the *Session Profile* option. The *Session Profile* window appears.

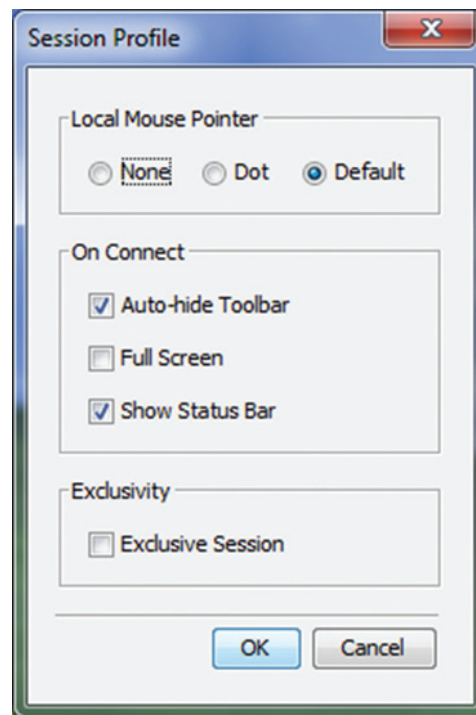

2. In the *Local Mouse Pointer* section, select one of the following options to set the appearance of the Client Computer's mouse pointer.

- *None* – Hides the Client Computer's mouse pointer altogether, so that only the Target Server's mouse pointer can be seen.
- *Dot* – Displays the Client Computer's mouse pointer as a dot.
- *Default* – Displays the Client Computer's mouse pointer in the standard format.

3. In the *On Connect* section, choose amongst the following options:

- *Auto hide* – When this checkbox is checked, the remote session toolbar will be collapsed upon logging into a remote session. When it is unchecked, the remote toolbar will remain displayed upon logging in.
- *Full Screen* – Check this checkbox to display the remote session screen in full screen mode upon logging into a remote session. This setting takes affect from the next connection onwards. To toggle full screen mode on and off, you can click the *Full Screen*  icon in the remote session toolbar. *Full Screen* mode can also be toggled on/off by pressing [Alt] + [Enter].
- *Show Status Bar* – Check this checkbox to display the Status Bar at the bottom of the remote session screen. This option is enabled by default.

3. Conducting a Remote Session

- In the *Exclusivity* section, check the *Exclusive Session* checkbox to prevent other accounts from accessing the Target Server port at the same time. By default, this checkbox is unchecked, and a remote session is initiated in *Share Mode*, which allows up to 5 accounts to log into a port at the same time (see the *Shared Session* section in this manual for details). **Note:** *Although an Exclusive Session prevents other accounts from remotely logging into a port at the same time as you, administrator accounts still have the ability to disconnect your session and access the port if desired, and a local account can access the port and disconnect your session.*
- About** – Selecting the *About* feature will bring up a screen that displays the NetCommander IP Client Version number and Firmware Version number.

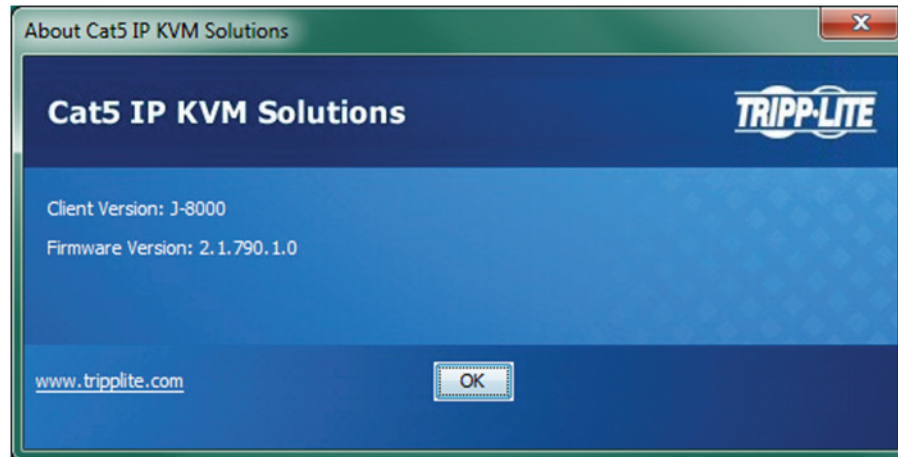

3.2.3 Video

 – Clicking on the *Video* icon will display a list of four options for managing the remote session's video: *Refresh*, *Video Adjust*, *Video Mode*, and *Advanced*.

- Refresh** – Selecting the *Refresh* feature will regenerate the remote screen to show the most current video. A video refresh may be necessary when changing the display attributes of a Target Server.
- Video Adjust** – Selecting the *Video Adjust* feature will perform an auto video adjust, which aligns the Target Server's video so that it displays properly in the remote session screen.
- Video Mode** – In the *Video Mode* feature, choose amongst the following options. After selecting an option, click the *Apply* button.

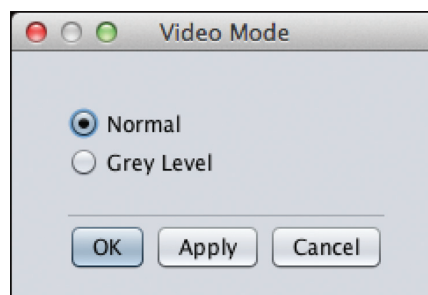

- Normal* – Select *Normal* to display the Target Server video normally, in full color. By default, the video mode is set to *Normal*.
 - Grey Level* – Select *Grey Level* to display the Target Server video in Black and White. In low-bandwidth networks, this can help improve keyboard and mouse response time by reducing the amount of video data traveling over the network.
- Advanced** - Although the *Refresh*, *Video Adjust*, and *Video Mode* features generally provide an automated way for you to optimize the remote session video, you may want to fine-tune the results. You can use the *Advanced* video adjustment screen to fine-tune the settings.

3. Conducting a Remote Session

To manually adjust the video settings:

1. Click on the  icon in the remote session toolbar, and choose the *Advanced* option. The *Advanced* window appears.

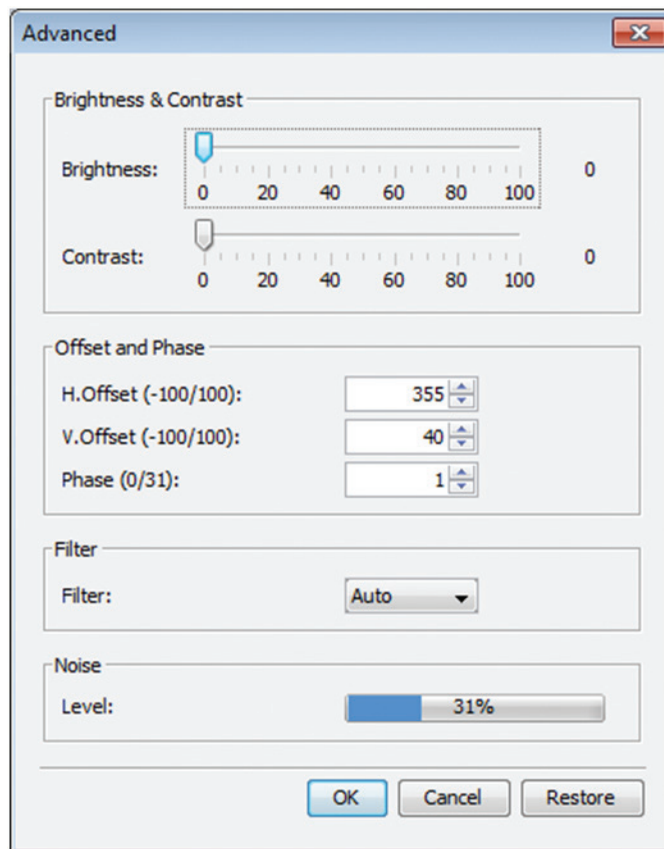

2. In the *Brightness & Contrast* section of the *Advanced* screen, use the corresponding scales to adjust the brightness and contrast of the displayed image.
3. In the *Offset, Phase and Scale* section of the *Advanced* screen, adjust the following settings accordingly:
 - In the *H. Offset* field, select the horizontal starting position of each line on the displayed image.
 - In the *V. Offset* field, select the vertical starting position of the displayed image.
 - In the *Phase* field, select the point at which each pixel is sampled.
4. In the *Filter* section of the *Advanced* screen, select the filter level of the video from the Target Server. A higher filter reduces the noise level but makes the image coarser. Options are: *Auto*, *No Filter*, *Low*, *Medium*, and *High*.
5. The *Noise Level* section of the *Advanced* screen displays the amount of video noise present when a static screen is displayed. The more noise that is present, the slower your keyboard and mouse response time will be. Adjusting the *Phase* and *Scale* fields can help decrease the noise level.
6. When you are done making changes, click the *OK* button. To exit without saving changes, click on the *Restore* button first.

3.2.4 Power

 – Clicking on the *Power* icon will display a list of three power management functions that can be performed on the currently selected Target Server. Select one of these functions to perform it on the Target Server. Upon selecting a power management function, a prompt appears asking for you to confirm the action. Click *Yes* to proceed. **Note:** *In order for power management functions to be performed on the Target Server, it must be mapped to a PDU that has been added to the NetCommander IP Power Devices page (see the Power Devices and Power Outlets sections in this manual for details).*

- *Power Cycle* – The *Power Cycle* function sends a signal to the Target Server to power it down and then back up again.
- *Power Up* – The *Power Up* function sends a signal to the Target Server to turn its power on.
- *Power Down* – The *Power Down* function sends a signal to the Target Server to turn its power off.

3. Conducting a Remote Session

3.2.5 Keys

 – Clicking on the *Keys* icon will display a list of predefined key sequences (e.g. Ctrl + Alt + Delete) that can be performed on the Target Server. By default, performing these key sequences on the Client Computer's keyboard sends the command to the Client Computer. Opening the *Keys* menu and clicking on one of the predefined commands will send it directly to the Target Server. In addition, the *Keys* feature allows you to add commands to the *Keys* drop-down list, and create commands that are not already provided.

Note: The *Predefined* and *Custom Keys* that are added to the *Special Key Manager* are unique to each port. You will need to customize the keyboard sequences that are available for each port. Once you do this, you will not need to do it again, except to add or remove keyboard sequences.

To add a keyboard sequence:

1. Click on the  icon in the remote session toolbar, and choose the *Special Keys* option. The *Special Key Manager* window appears.

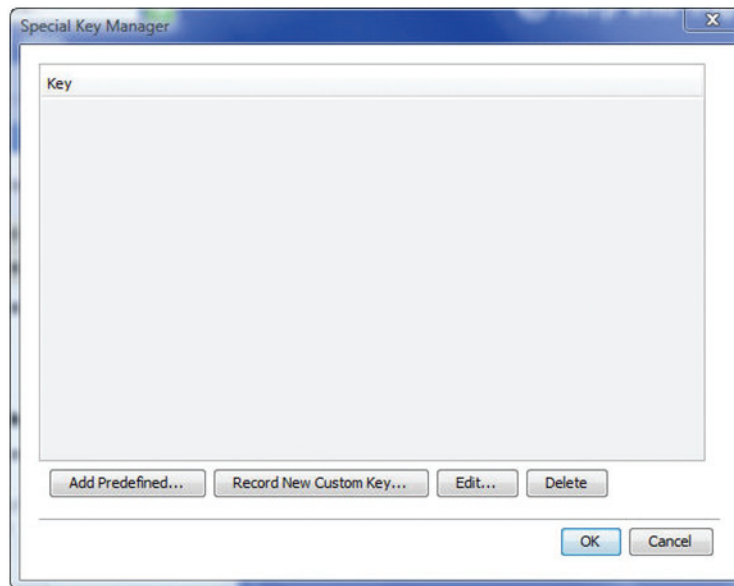

2. Click the *Add Predefined* button to pull up a list of predefined command sequences.

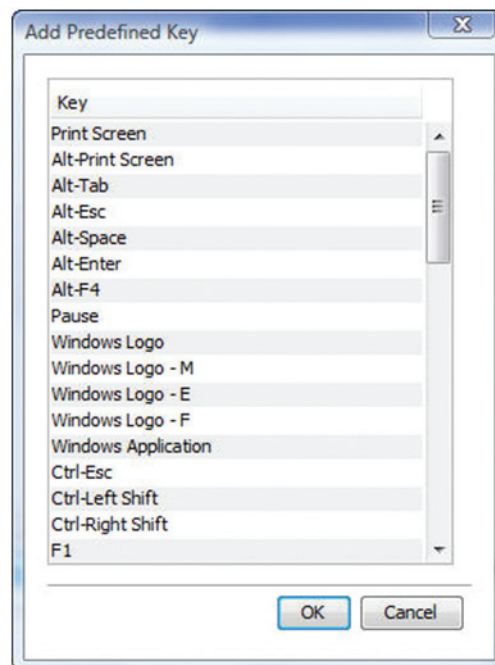

3. Select a key sequence and click *OK*. The sequence appears in the *Special Key Manager* window.
4. In the *Special Key Manager* window, click *OK*. The sequence appears in the *Keys* drop-down list.

3. Conducting a Remote Session

To record a keyboard sequence:

1. Open the *Special Key Manager* window and click the *Record New Custom Key* button. The *Record New Custom Key* macro screen appears.



2. In the *Label* field, type a name for the new key sequence.
3. Click the *Start Recording* button.
4. On your keyboard, press the keys to include in the key sequence. The names of the pressed keys appear in the provided area as you type them.
5. When done with the sequence, click the *Stop Recording* button.
6. Click the *OK* button. The new key sequence is now on the list of predefined key sequences.

To edit a predefined keyboard sequence:

1. Open the *Special Key Manager* window, select the desired key sequence, and then click the *Edit* button. The *Record New Custom Key* macro screen appears, with the name of the key sequence to edit appearing in the *Label* field.
2. Click the *Start Recording* button.
3. On your keyboard, press the keys to include in the key sequence. The names of the pressed keys appear in the provided area as you type them.
4. Click the *Stop Recording* button.
5. Click the *OK* button. The key sequence definition is updated in the system.

To delete a keyboard sequence:

1. Open the *Special Key Manager* window, select the desired key sequence, and then click the *Delete* button. A prompt appears asking you to confirm the action. **Note:** To select a group of keys, highlight the first key in the group, press and hold down the [Shift] button, and then highlight the last key in the group.
2. Click Yes to proceed.

3. Conducting a Remote Session

3.2.6 Mouse

 – Clicking on the *Mouse* icon allows you to select the *Mouse Settings* mode being used, as well as to manually adjust settings related to mouse synchronization. The following section describes the settings found via the *Mouse* icon and how to use them, as well as general tips for mouse synchronization and improving keyboard/mouse response time.

To set the *Mouse Settings* mode:

1. Click on the  icon in the remote session toolbar, and choose the *Mouse Settings* option. The *Mouse Settings* window appears.

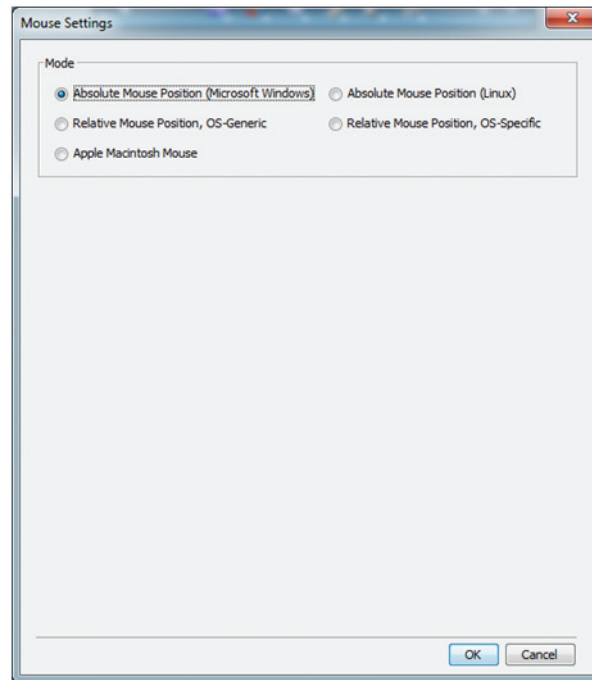

2. By default, the *Absolute Mouse Position (Microsoft Windows)* mode is selected for Target Servers connected using a USB SIU. *Relative Mouse Position (OS-Specific)* mode is the default for Target Servers connected using a PS/2 SIU. You can manually select among the following:
 - ***Absolute Mouse Position (Microsoft Windows)*** – *Absolute Mouse Position (Microsoft Windows)* mode should be used if the Target Server's operating system is Windows ME or later. The *Absolute Mouse Position (Microsoft Windows)* function automatically sends the mouse coordinates to the remote session, providing optimal synchronization. You do not need to manually configure any mouse settings when *Absolute Mouse Position* is selected. **Note:** *Absolute Mouse Position mode cannot be used for Target Servers connected with a PS/2 SIU.*
 - ***Absolute Mouse Position (Linux)*** – *Absolute Mouse Position (Linux)* mode should be used if the Target Server uses a Linux operating system, such as Ubuntu. The *Absolute Mouse Position (Linux)* function automatically sends the mouse coordinates to the remote session, providing optimal synchronization. You do not need to manually configure any mouse settings when *Absolute Mouse Position* is selected. **Note:** *Absolute Mouse Position mode cannot be used for Target Servers connected with a PS/2 SIU.*
 - ***Relative Mouse Position, OS-Generic*** – *Relative Mouse Position, OS-Generic* mode should be used if the other mouse settings modes are not performing satisfactorily. When this mode is in effect, the user must focus the mouse within the remote session window by clicking inside of it. From then on the mouse remains captured, and any mouse movement will remain within the borders of the remote session window. To exit out of this mode, press [Ctrl] + [Alt].
 - ***Relative Mouse Position, OS-Specific*** – *Relative Mouse Position, OS-Specific* mode should be used when the Target Server is running Linux operating systems other than Ubuntu, or Windows operating systems prior to ME. When selected, additional settings are provided that allow you to manually configure the *Mouse Settings* according to your Target Server's OS (see the *Relative Mouse Position, OS-Specific Mode* section in this manual for details on the available settings).
 - ***Apple Macintosh Mouse*** – *Apple Macintosh Mouse* mode should be used if the Target Server is a Mac. The *Apple Macintosh Mode* function automatically sends the mouse coordinates to the remote session, providing optimal synchronization. You do not need to manually configure any mouse settings when this mode is selected. **Note:** *Apple Macintosh Mouse mode cannot be used for Target Servers connected with a PS2 SIU.*

3. Conducting a Remote Session

To configure settings in Relative Mouse Position, OS-Specific mode:

1. Click on the  icon in the remote session toolbar, and choose the *Mouse Settings* option. The *Mouse Settings* window appears.
2. Check the *Relative Mouse Position, OS-Specific* checkbox. Additional settings appear that allow you to manually configure the mouse settings according to your Target Server's OS and mouse type.

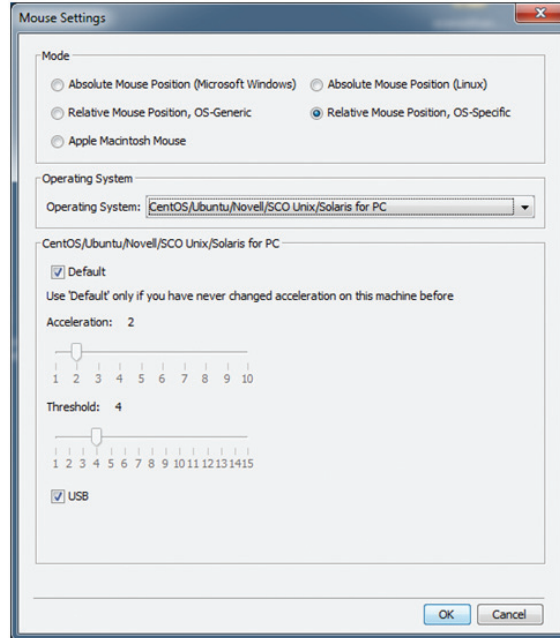

3. In the *Operating System* field, select your Target Server's operating system from the drop-down menu. Instructions and slider bars appear on the screen according to the chosen operating system.
4. Configure these settings to match those shown in the Target Server's Mouse Properties window. **Note:** If the mouse settings of the remote computer have ever been changed (even if they were changed and then returned to the original settings) uncheck the Default checkbox and edit the settings to match those of the Target Server.
5. Check the *USB* checkbox if the Target Server is connected with a USB SIU.
6. When you are done configuring all settings, click the *OK* button to close out of the *Mouse Settings* window. Upon moving the mouse in the remote session screen, the pointers should align. If needed, use the *Align* feature (see the *Align* section in this manual for details) of the *Mouse* drop-down in the toolbar.

3. Conducting a Remote Session

To align the mouse pointers:

Note: The *Align* function is only available in the Mouse drop-down menu when the Mouse Settings mode is set to Relative Mouse Position.

When logging into the KVM or accessing a new port, the local and remote mouse pointers may not be aligned. This does not always mean that they are not set up properly. Click on the *Align* feature in the *Mouse* drop-down menu of the toolbar to bring them together.

1. Click on the  icon in the remote session toolbar, and choose the *Align* option (or press [Ctrl] + [M]). The mouse pointers align.
2. If the mouse pointers do not align, try manually configuring the mouse settings (see the *Mouse Settings Mode* and *Relative Mouse Position Mode* sections in this manual for details).

To calibrate the mouse pointers:

Note:

- The *Calibrate* function is only available in the Mouse drop-down menu when the Mouse Settings mode is set to Relative Mouse Position.
 - The *Calibrate* function works with computers running Linux, or Windows NT4, 98 or 2000.
1. Click on the  icon in the remote session toolbar, and choose the *Calibrate* option. The mouse pointers align.
 2. If the mouse pointers do not align, try using the *Align* function, or manually configuring the mouse settings (see the *Mouse Settings Mode* and *Relative Mouse Position Mode* sections in this manual for details).

Mouse Synchronization and Keyboard/Mouse Response Time Tips:

If the local and remote mouse pointers do not align, or your keyboard/mouse response time is slow, try the following:

- Go into the Target Server's *Mouse Properties* screen and make sure that the *Enhanced Pointer Precision* setting is unchecked. If checked, the local and remote mouse pointers will not align. The image below shows this screen from a Windows Vista computer.

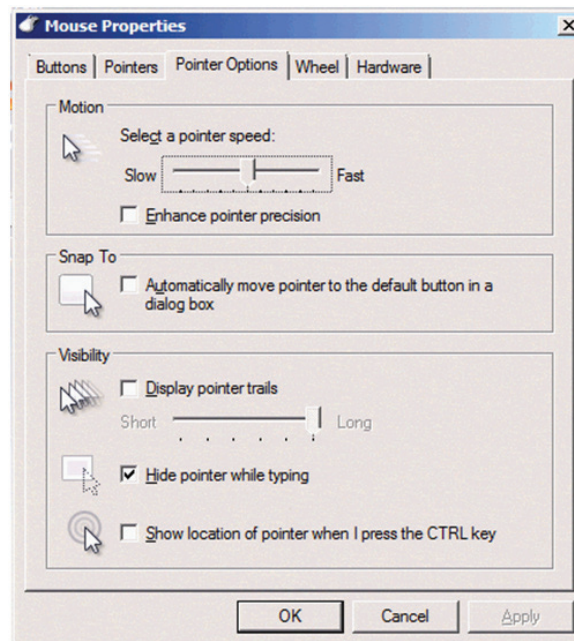

- There are times when a *Video Adjust* does not properly align the Target Server's video in the remote session screen. If the screen is not aligned properly (you will see a black bar on a side of the remote screen, and part of the remote screen will not be displayed), the local and remote mouse pointers will not align. Try performing another *Video Adjust* to bring the screen into alignment. If this still does not work, you will need to manually adjust the *H. Offset* and/or *V. Offset* settings in the *Advanced* screen to bring the screen into alignment. (See the *Advanced* video settings section in this manual for details.)
- If you are using non-shielded Cat5/6 cable, try using Tripp Lite N105-Series Cat5e shielded patch cable. Any noise that exists in the cabling can affect local and remote mouse alignment, and switching to shielded cabling eliminates that noise.
- Change the *Video Mode* (see the *Video Mode* section in this manual for details) to decrease the amount of information being transferred over the network. The less data that is being sent, the faster the keyboard/mouse response time. In particular, the *Grey Level* setting can help improve keyboard and mouse response time.
- Go to the display settings section of the Target Server and lower the video resolution, refresh rate and color settings.
- If the Target Server has a graphic desktop background, change it to a solid color background.
- If the target server is in BIOS boot mode, the ability to change mouse mode settings is temporarily disabled. When BIOS mode exits, mouse mode settings can be opened and settings edited.

3. Conducting a Remote Session

3.2.7 Server/Serial

 – Clicking on the *Server/Serial* icon displays a drop-down list of ports that are accessible to the currently logged-in account. Simply select a port to access it.

3.2.8 Full Screen

 – Clicking on the *Full Screen* icon (or pressing [Alt] + [Enter]) toggles full screen mode on/off.

3.2.9 Logout

 – Clicking the *Logout* icon closes your remote session, but does not log you out of the Web Configuration Interface.

3.3 Shared Session

By default, a remote session is accessed in *Share Mode*, unless the *Exclusive Session* checkbox in the *Session Profile* screen is checked (see the *Session Profile* section in this manual for details). *Share Mode* gives access to up to 5 accounts to the same port at the same time, allowing them to collaborate their work and share a remote session. All accounts in a shared session see video at the same time and share the Keyboard/Mouse control. Keyboard/mouse commands are performed by whichever account takes control. Once an account stops using the keyboard/mouse, another account can immediately start using it. When initiating a remote session in *Share Mode*, the following message appears:

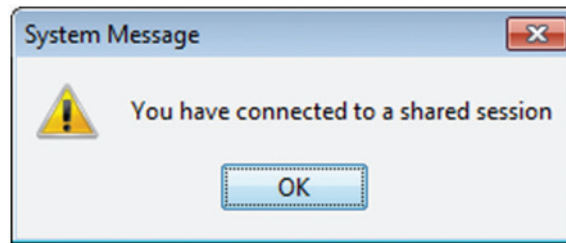

3.4 Exclusive Session

When in a remote session without any other logged in accounts, you can prevent other accounts from accessing the same port as you by checking the *Exclusive Session* checkbox in the *Session Profile* screen (see the *Session Profile* section of this manual for details). An account accessing a Target Server in an *Exclusive Session* is the only one who can see the video and control the Keyboard/Mouse; other accounts are prevented from accessing the port at the same time. **Note:** *Exclusive Mode prevents accounts from remotely accessing a port at the same time; however, administrator accounts still have the ability to disconnect a session and then take over access to the port, and a local account can access the port and disconnect your session.*

4. Local Console

This chapter explains how to operate the NetCommander IP via the local console. The local console allows you to access connected computer/servers, configure the KVM's network settings, and to configure some more basic settings specific to local access.

To display the OSD:

1. From the local keyboard, press the left **Shift** key twice. The OSD Main window appears.

Lines with sun icons in the **PM** column show active computers/servers. A computer that is connected, but is powered-off, does not have a sun icon. When a server is busy (when an account is accessing it in an *Exclusive Session*), the entire line appears in red characters.

| NAME | USER | PM |
|--------------|------|----|
| 01 Server 01 | | ☀️ |
| 02 Server 02 | | ☀️ |
| 03 Server 03 | | ☀️ |
| 04 Server 04 | | ☀️ |
| 05 Server 05 | | ☀️ |
| 06 Server 06 | | |
| 07 Server 07 | | |
| 08 Server 08 | | |

MOVE LABEL F1 ESC-LOGOUT
TUNING F5 F2-SETTING

Navigating the OSD:

- To move the highlight bar throughout the list, press the [↑] and [↓] arrow keys.
- To jump from one column to the next (when relevant), press the [Tab] key.
- To exit the OSD or return to a previous window within the OSD, press the [Esc] key.

To select a computer:

1. Navigate to the desired port using the [↑] and [↓] arrow keys, or type the two-digit port number of the desired computer.
2. Press the [Enter] key. The selected computer is accessed.

4.1 Move Label (F1)

When a Target Server is accessed via the local console, a *Confirmation Label* appears briefly, displaying the port number and name of the Target Server being accessed. After a few seconds, the *Confirmation Label* disappears. You can position the *Confirmation Label* anywhere on the screen using the OSD's *MOVE LABEL (F1)* function.

1. Open the OSD and highlight the desired computer using the [↑] and [↓] arrow keys.
2. Press the [F1] key. The selected port's video and *Confirmation Label* appear.
3. Use the arrow keys to move the label to a desired position on the screen.
4. Press the [Esc] key to save the position and exit.

4.2 Tuning (F5)

You can tune the image of any Target Server using the OSD's *TUNING (F5)* function.

1. Open the OSD and highlight the desired computer using the [↑] and [↓] arrow keys.
2. Press the [F5] key. The selected port's video and the *Image Tuning Label* appears.

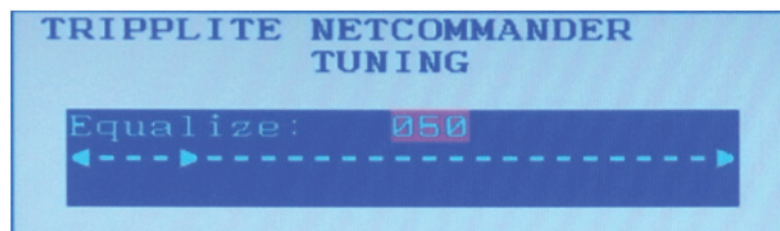

3. Use the [↑] and [↓] arrow keys to adjust the image.
4. When the image is satisfactory, press the [Esc] key.

4. Local Console

4.3 Power Management

As with the Web Configuration Interface, you are able to perform power management functions via the local console. The power management functions available to you are described below. **Note:** In order to perform power management actions on a port, it must be configured to match a power outlet of a power device that has been added to the KVM. (See the Power Device and Power Outlets sections of this manual for details)

Cycle – Choose the *Cycle* option to perform a power cycle on the computer/server connected to the selected port.

Up – Choose the *Up* option to turn the power to the computer/server connected to the selected port on.

Down – Choose the *Down* option to turn the power to the computer/server connected to the selected port off.

To Power Manage a computer:

1. Open the OSD and highlight the desired computer using the [↑] and [↓] arrow keys.
2. Press the [Enter] key to access the highlighted computer.
3. When accessing the computer, press and release the left [Shift] key, and then press and release the [F12] key. **Note:** This hotkey combination will change if the hotkey combination used to open the OSD is changed. When the OSD hotkey is [Shift] + [Shift], the Power Management hotkey is [Shift] + [F12]. When the OSD hotkey is [Ctrl] + [Ctrl] or [Ctrl] + F11, the Power Management hotkey is [Ctrl] + [F12]. When the OSD hotkey is [Print Screen] + [Print Screen], the Power Management hotkey is [Print Screen] + [F12].
4. The Power Control dialog box appears.

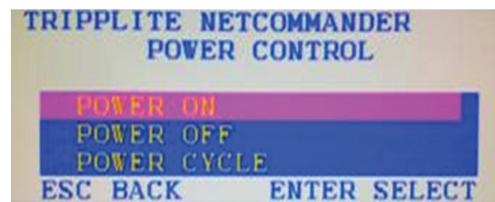

5. Highlight the desired function using the [↑] and [↓] arrow keys, and then press the [Enter] key.
6. A prompt appears, asking you to confirm the operation.

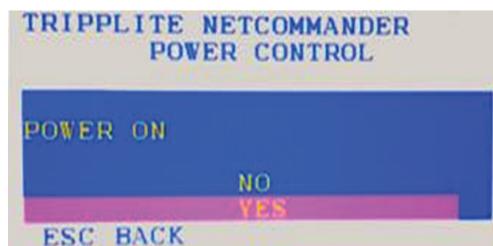

7. To perform the selected operation, choose Yes. The power command is sent.

4.4 (F2) Setting

The OSD's F2 – SETTING menu allows you to configure the following settings:

- Device IP address
- OSD hotkey
- Keyboard language
- DDC

To open the FW – SETTING screen, simply open the OSD and press the [F2] key.

You can navigate through the page by pressing the [Tab] key. At the bottom of the window, pressing the [Tab] key will take you back to the top of the window. Change settings by typing in the selected area or by pressing the spacebar – whichever is relevant.



4. Local Console

To set the IPv4 address via the local console OSD:

1. From the local console, press the left **[Shift]** key twice to open the OSD.
2. Press the **[F2]** key to open the *Settings* menu.
3. In the *Settings* menu, press the **[Tab]** key until the *DHCP* field is highlighted. Press the **[Spacebar]** key to toggle the *DHCP* field from *Enabled* to *Disabled*.
4. Pressing the **[Tab]** key to navigate to the additional fields, type in the desired *IP Address*, *Subnet Mask*, *Gateway*, and *DNS Server Address* (Optional).
5. Once the IP address is satisfactory, press the **[Esc]** key to save your changes. This will require that the KVM be rebooted to save the new settings.

```
TRIPPLITE NETCOMMANDER
MAIN

-- NAME          USER  PM
01 Server 01
02 Server 02
03 Server 03
04 Server 04
05 Server 05
06 Server 06
07 Server 07
08 Server 08
MOVE LABEL F1   ESC-LOGOUT
TUNING         F5   F2-SETTING
```

```
TRIPPLITE NETCOMMANDER
SETTINGS

MAC_ADDR 00:15:9D:02:EE:01
DHCP DISABLED
IP ADDRESS 192.168.111.23
SUBNET MASK 255.255.255.0
GATEWAY    192.168.111.1
DNS IP (Opt) 192.168.111.2
HOTKEY : Shift-Shift
KEYBOARD LANGUAGE : English

Toggle-Space  Navigate-Tab
DDC-F10      Next-F2      Save-ESC
```

To set the IPv6 address via the local console OSD:

1. From the local console, press the left **[Shift]** key twice to open the OSD.
2. Press the **[F2]** key to open the *Settings* menu, and then press the **[F2]** key again to open the *IPv6 Settings* menu.
3. In the *IPv6 Settings* menu, with the *Mode* field at the top of the screen highlighted, press the **[Spacebar]** key to toggle between *DHCP*, *Stateless*, and *Static*. *DHCP* is selected by default, and automatically assigns an IP address via the IPv6 DHCP server. *Stateless* is an option for networks with a compliant router that automatically assigns an IP address based on the MAC address of the unit. *Static* allows you to manually assign an IP address.
4. Pressing the **[Tab]** key to navigate to the additional fields, type in the desired *IP Address*, *Gateway*, and *DNS Server Address* (Optional).
5. Once the IP address is satisfactory, press the **[Esc]** key twice to exit and save your changes. This will require that the KVM be rebooted to save the new settings.

```
TRIPPLITE NETCOMMANDER
IPv6 SETTINGS

Mode DHCP
IP ADDRESS
2001:db8:0:1:12d / 64
DEFAULT GATEWAY
fe80::21b:21ff:fe0d:
f959
DNS IP (Optional)
2001:db8:0:1:128

Toggle-Space  Navigate-Tab
Back-ESC
```

4. Local Console

Changing the Hotkey:

By default, the hotkey combination used to open the OSD is [Shift] + [Shift]. You can change this hotkey in the *F2 – SETTING* menu to use any of the following. **Note:** *The left [Shift] hotkey must be used; the right [Shift] key will not work. If you set the hotkey to [Ctrl] + [Ctrl] or [Ctrl] + [F11], the left [Ctrl] key must be used.*

- [Shift] + [Shift]
- [Ctrl] + [Ctrl]
- [Ctrl] + [F11]
- [Print Screen] + [Print Screen]

To change the hotkey:

1. In the *F2 - SETTING* window, navigate to the *Hotkey* field.
2. Press the [Spacebar] key to toggle between the available options.
3. After choosing the desired hotkey, press the [Esc] key to exit the *F2 – SETTING* window.

To change the keyboard language:

By default, the keyboard language is preset to US English. You can change the keyboard language to French (FR) or German (DE). **Note:** *This refers to the OSD keyboard language and not the computer keyboard language.*

To change the keyboard language:

1. In the *F2 - SETTING* window, navigate to the *Keyboard Language* field.
2. Press the [Spacebar] key to toggle between the available options.
3. After choosing the desired language, press the [Esc] key to exit the *F2 – SETTING* window.

Inputing and Updating DDC Information:

Display Data Channel (DDC) is a VESA standard for communication between a monitor and a video adapter. The SIU emulates the DDC information to the connected computer. When first installing the NetCommander IP system, emulate the DDC information of the connected monitor into the memories of all connected SIUs.

To input the DDC information:

1. In the *F2 - SETTING* window, press the [F10] key. The text “Please wait” flashes a few times and disappears. The monitor’s DDC information is sent to all SIUs.

You should update the DDC information in any of the following circumstances:

- When replacing the monitor connected to the NetCommander IP
- When adding a new SIU to the system
- When reconnecting an existing SIU that was temporarily used in a different system

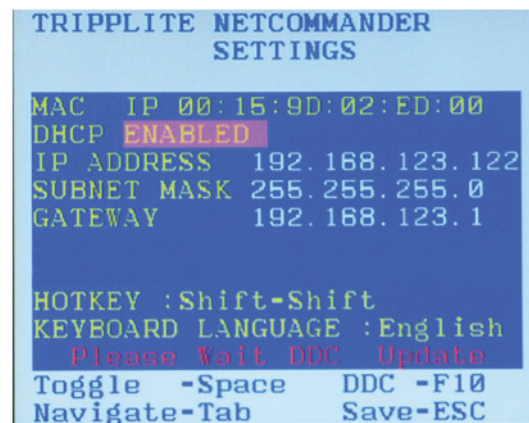

5. Serial Port Pinout

Note: When connecting a Cisco device, use Cisco rolled cable.

Serial Port 1:

Pin 1: RTS

Pin 2: DTR

Pin 3: TX

Pin 4: GND

Pin 5: GND

Pin 6: RX

Pin 7: DSR (pins 7 and pin 2 are shorted inside the unit)

Pin 8: CTS

Serial Port 2:

Pin 1: RTS

Pin 2: DTR

Pin 3: TX

Pin 4: GND

Pin 5: GND

Pin 6: RX

Pin 7: DSR

Pin 8: CTS

6. Security Certificate Installation

When remotely logging in to the KVM, you may get security warnings from your Web browser and/or Java pop-up stating that the connection to the website cannot be trusted. This occurs because the KVM's security certificate is not among the browser and/or Java control panel's list of trusted certificates. To add the certificate to the list of trusted certificates, follow the steps in this section. Once installed, the security warning will no longer appear. **Note:** If the IP address of the KVM switch is changed, you will need to reinstall the security certificate.

Browser Security

The following steps apply to Internet Explorer 9, but may also be used with other Web browsers. **Note:** You may need to run Internet Explorer as an Administrator to install the security certificate.

1. Upon logging into the KVM, a screen will appear stating that there is a problem with the website's security certificate. Click on *Continue to this website (not recommended)*.

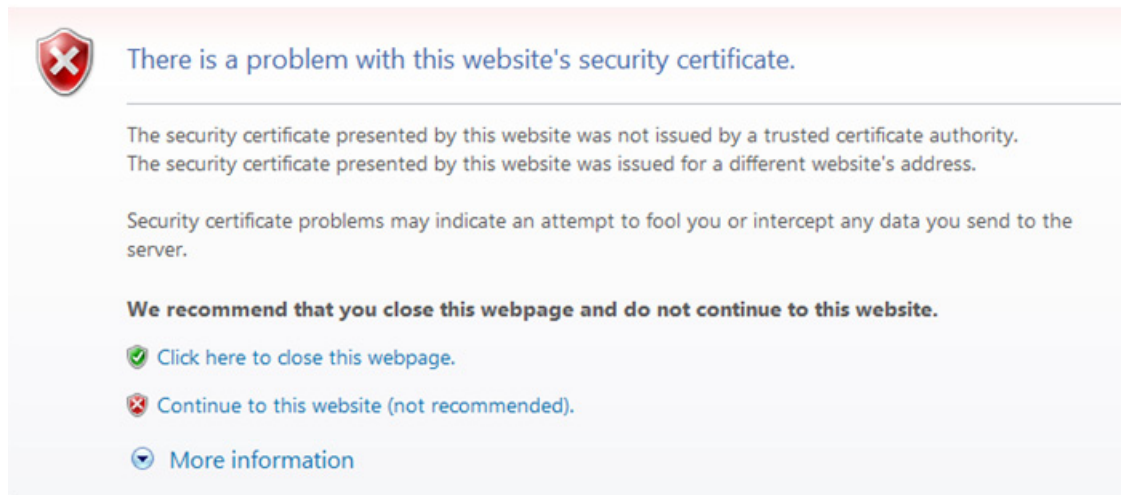

2. A URL bar will appear with a *Certificate error* message.

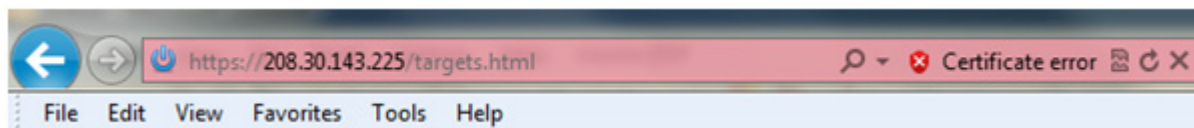

6. Security Certificate Installation

3. Click on the *Certificate error* message to display the *Certificate Invalid* prompt.

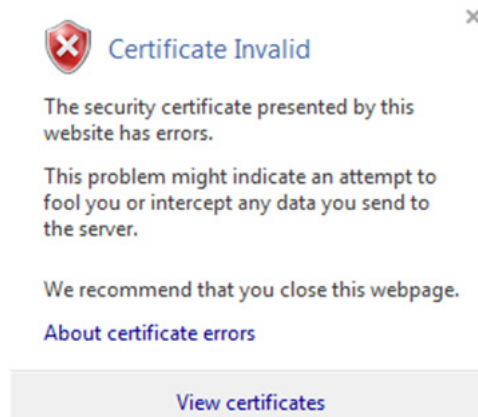

4. Click on the *View certificates* option at the bottom of the prompt to redirect to the *Certificate* screen.

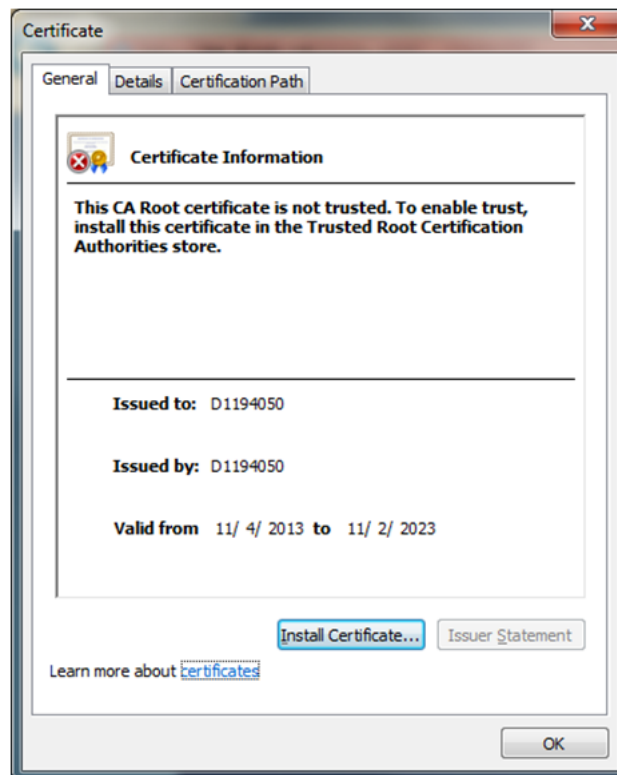

6. Security Certificate Installation

- Click on the *Install Certificate* button to bring up the *Certificate Import Wizard*, then click the *Next* button.

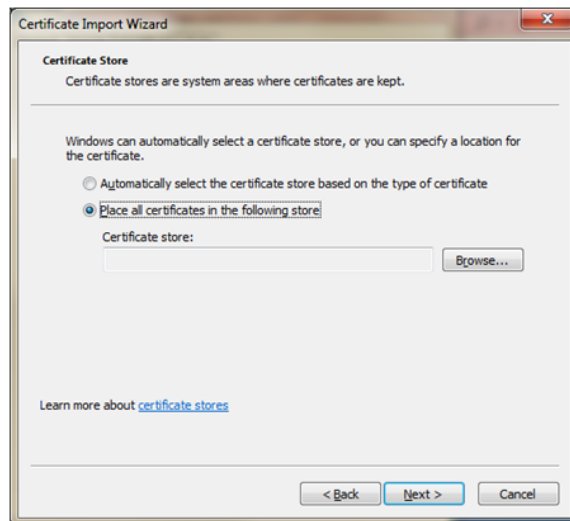

- Select the option to *Place all certificates in the following store*, then click the *Browse* button. Highlight the *Trusted Root Certification Authorities* folder.

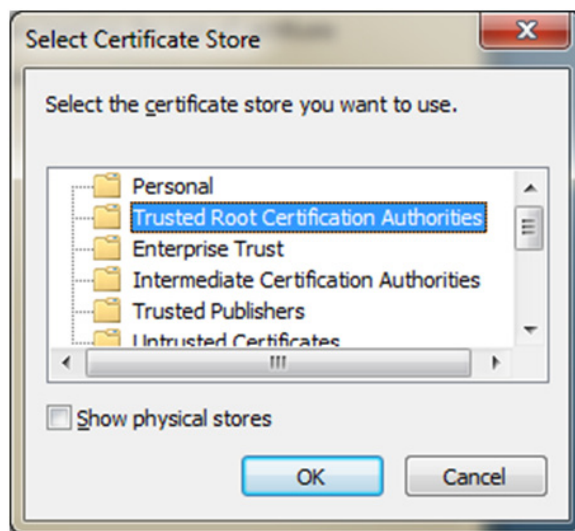

- Click *OK*. You will be redirected back to the previous screen. Click *Next*, followed by *Finish*. Upon clicking *Finish*, you will be prompted to confirm installation of the certificate.

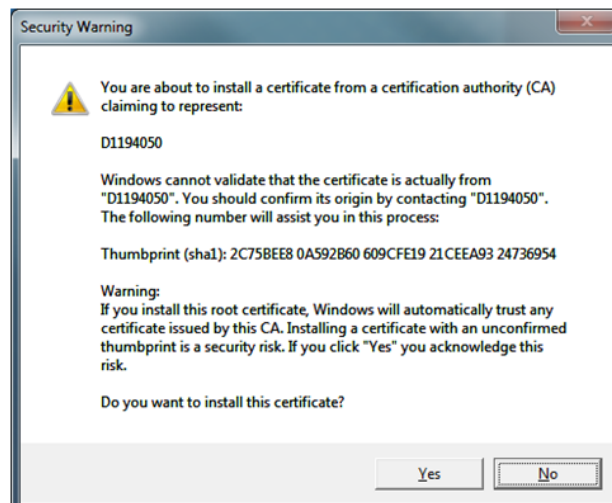

- Click *Yes* to complete the certificate's installation.

6. Security Certificate Installation

Java Security

The following steps apply to Internet Explorer 9 and Java version 1.7.0_45, but may also be used with other Web browsers and Java versions. **Note:** You may need to run Internet Explorer as an Administrator to install the security certificate.

1. Open your Web browser and login to the KVM. If the KVM certificate has not yet been installed in the browser, a URL bar with a *Certificate error* message will appear. Click on the *Certificate error* or *Security Lock* icon in the toolbar to pull up the *Certificate* screen.

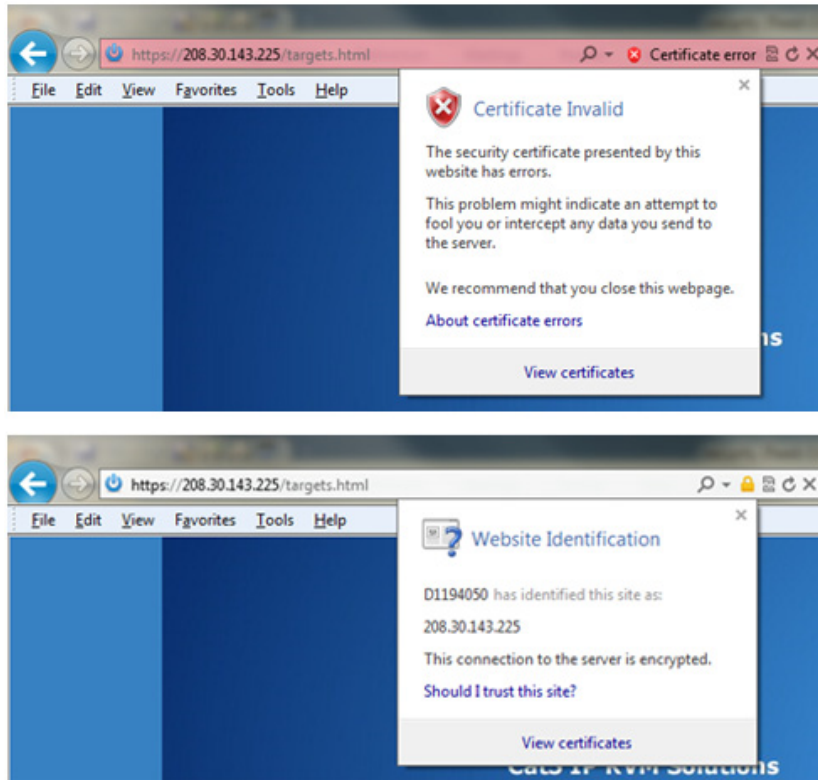

2. Click on the *View Certificates* option. When the *Certificate* window appears, click on the *Details* tab.

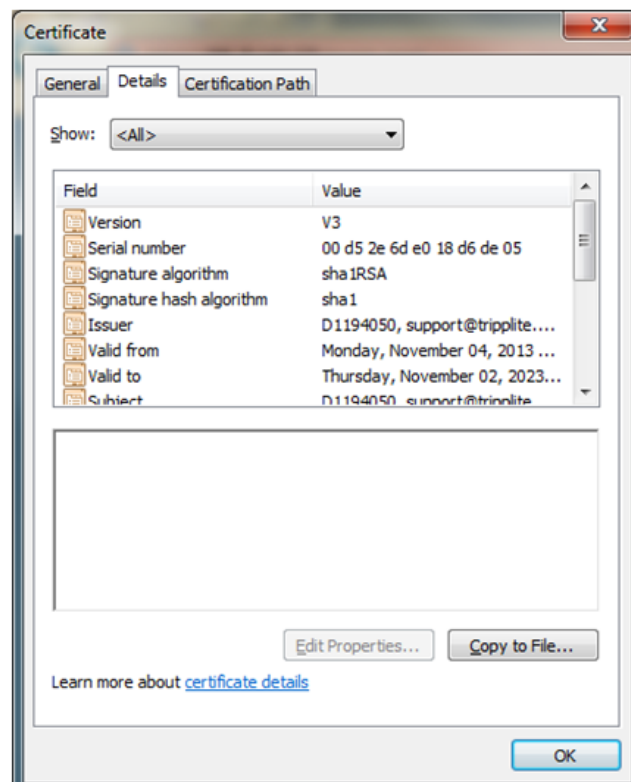

6. Security Certificate Installation

- In the *Details* tab page, click on the *Copy to File* button. The *Certificate Export Wizard* appears.



- Click *Next*, accepting the default values until you get to the *File to Export* page.

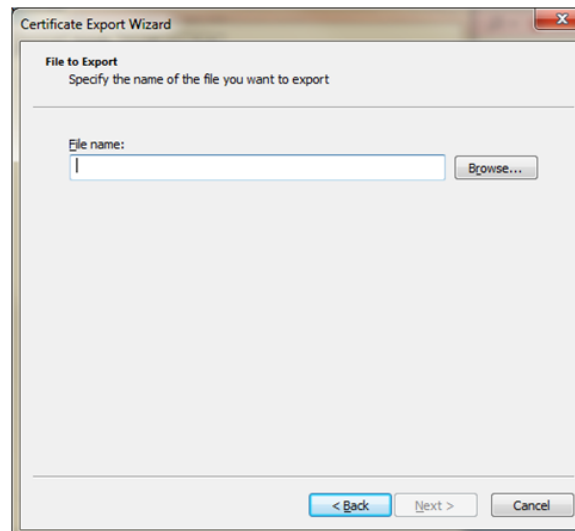

- Click the *Browse* button to navigate the location you want to save the certificate file, and then type a name into the *File name* field. Click *Next* to go back to the *File to Export* screen, where the file path will be entered.

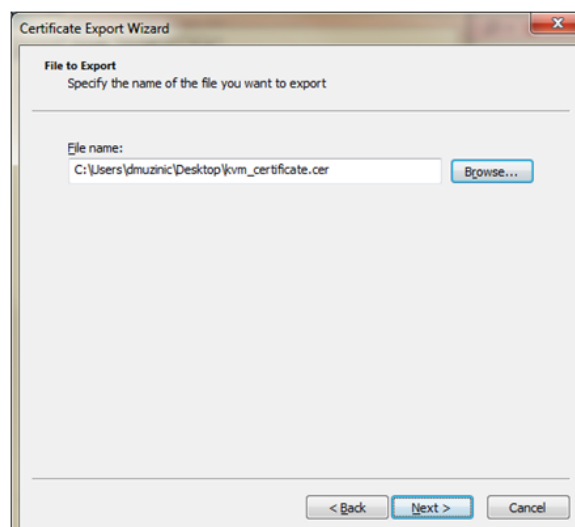

6. Security Certificate Installation

- Click the *Next* button, followed by the *Finish* button on the next page to complete export of the KVM certificate.
- Navigate to your computer's *Control Panel* window and open the *Java Control Panel*.

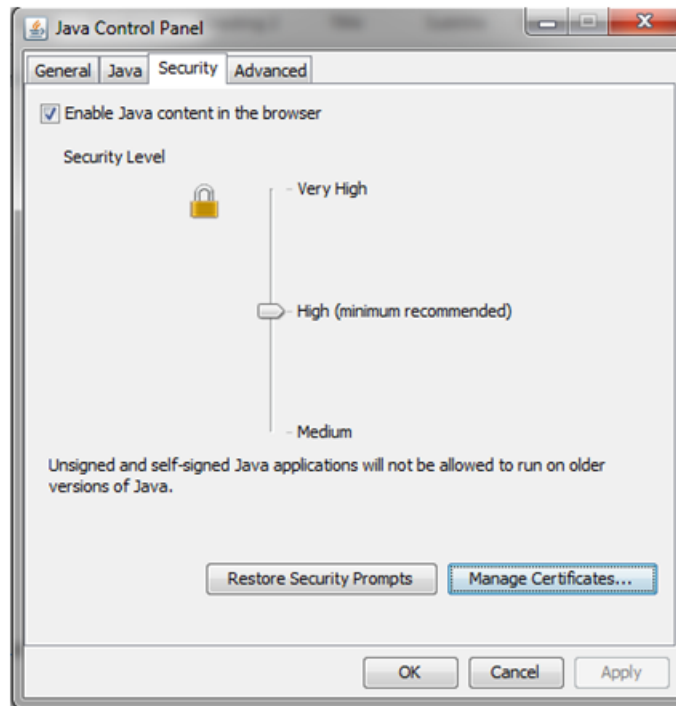

- Click on the *Security* tab, then click the *Manage Certificates* button.

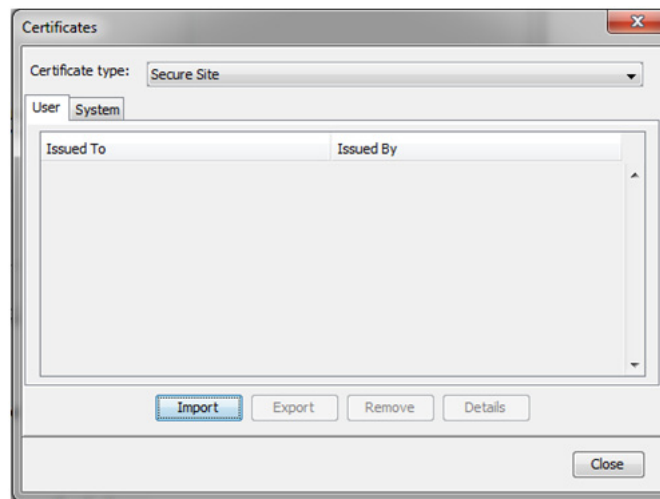

- In the *Certificate type* drop-down menu at the top of the screen, select the *Secure Site* option.
- Click the *Import* button and navigate to the location where the KVM certificate file is saved. Click *OK* to add the KVM certificate to the *Secure Sites* list to complete installation.

7. Technical Specifications

| Specification | Description |
|-------------------------------------|--|
| Operating systems | Target Server – Windows and Linux Client computer – Windows with Internet Explorer, Firefox, or Chrome browsers. Linux with Firefox or Chrome browsers. |
| Max Resolution | 1920 x 1080 (Local console monitor on B070- Series supports a max video resolution of 1366 x 768) |
| Distance from Switch to SIUs | Up to 100 ft. (30 m.) |
| Security | SSL, high grade 128-bit AES encryption |
| Connections | Ethernet – (x2) RJ45 – 10/100 Mbps Serial – (x2) RJ45 Local KVM connection (B072-Series Only) – VGA (HD15); Keyboard/Mouse (x2) USB Server – (x16) RJ45 – 116IP / (x8) RJ45-108IP |
| Power input | 100-240 VAC, 50/60 Hz |
| Operating temperature | 0°C to 40°C / 32° to 104°F |
| Storage temperature | -40°C to 70°C / -40°F to 158°F |
| Humidity | 80% non-condensing relative humidity |

| Specification | B078-101-PS2 SIU | B078-101-USB-1 | B078-101-USB2 |
|--------------------|--|--|--|
| Connections | VGA – HD15 KM – (x2) MiniDin6 System – RJ45 | VGA – HD15 KM – USB System – RJ45 | VGA – HD15 KM – USB FVM – USB System – RJ45 |
| Power | From Keyboard port | From USB port | From USB port |

8. Video Resolution and Refresh Rates

| Hz → | 56 | 60 | 65 | 66 | 70 | 72 | 73 | 75 | 76 | 85 | 86 |
|-----------|----|----|----|----|----|----|----|----|----|----|----|
| 640x480 | | X | | X | X | X | | X | | X | |
| 720x400 | | | | | X | | | | | X | |
| 800x600 | X | X | | | | X | | X | | X | X |
| 1024x768 | | X | | | X | X | X | X | X | X | |
| 1152x864 | | | | | | | | X | | | |
| 1152x900 | | | | X | | | | | X | | |
| 1280x720 | | X | | | | | | | | | |
| 1280x768 | | X | | | | | | X | | | |
| 1280x960 | | X | | | | | | | | X | |
| 1280x1024 | | X | | | | X | | X | X | X | |
| 1600x1200 | | X | | | | | | | | | |
| 1920x1080 | | X | | | | | | | | | |
| 1920x1200 | | X | | | | | | | | | |

Note: The local console monitor on the B070-008-19-IP and B070-16-19-IP supports video resolutions up to 1366 x 768.

9. Warranty and Warranty Registration

Limited Warranty

TRIPP LITE warrants its products to be free from defects in materials and workmanship for a period of two (2) years (B072-008-1-IP and B072-016-1-IP) or one (1) year (B070-008-19-IP and B070-016-19-IP) from the date of initial purchase. TRIPP LITE's obligation under this warranty is limited to repairing or replacing (at its sole option) any such defective products. To obtain service under this warranty, you must obtain a Returned Material Authorization (RMA) number from TRIPP LITE or an authorized TRIPP LITE service center. Products must be returned to TRIPP LITE or an authorized TRIPP LITE service center with transportation charges prepaid and must be accompanied by a brief description of the problem encountered and proof of date and place of purchase. This warranty does not apply to equipment which has been damaged by accident, negligence or misapplication or has been altered or modified in any way.

EXCEPT AS PROVIDED HEREIN, TRIPP LITE MAKES NO WARRANTIES, EXPRESS OR IMPLIED, INCLUDING WARRANTIES OF MERCHANTABILITY AND FITNESS FOR A PARTICULAR PURPOSE. Some states do not permit limitation or exclusion of implied warranties; therefore, the aforesaid limitation(s) or exclusion(s) may not apply to the purchaser.

EXCEPT AS PROVIDED ABOVE, IN NO EVENT WILL TRIPP LITE BE LIABLE FOR DIRECT, INDIRECT, SPECIAL, INCIDENTAL OR CONSEQUENTIAL DAMAGES ARISING OUT OF THE USE OF THIS PRODUCT, EVEN IF ADVISED OF THE POSSIBILITY OF SUCH DAMAGE. Specifically, TRIPP LITE is not liable for any costs, such as lost profits or revenue, loss of equipment, loss of use of equipment, loss of software, loss of data, costs of substitutes, claims by third parties, or otherwise.

WARRANTY REGISTRATION

Visit www.tripplite.com/warranty today to register the warranty for your new Tripp Lite product. You'll be automatically entered into a drawing for a chance to win a FREE Tripp Lite product!*

* No purchase necessary. Void where prohibited. Some restrictions apply. Open to U.S. residents only. See www.tripplite.com for details.

FCC Notice, Class A

This device complies with part 15 of the FCC Rules. Operation is subject to the following two conditions: (1) This device may not cause harmful interference, and (2) this device must accept any interference received, including interference that may cause undesired operation.

Note: This equipment has been tested and found to comply with the limits for a Class A digital device, pursuant to part 15 of the FCC Rules. These limits are designed to provide reasonable protection against harmful interference when the equipment is operated in a commercial environment. This equipment generates, uses, and can radiate radio frequency energy and, if not installed and used in accordance with the instruction manual, may cause harmful interference to radio communications. Operation of this equipment in a residential area is likely to cause harmful interference in which case the user will be required to correct the interference at his own expense. The user must use shielded cables and connectors with this equipment. Any changes or modifications to this equipment not expressly approved by Tripp Lite could void the user's authority to operate this equipment.

WEEE Compliance Information for Tripp Lite Customers and Recyclers (European Union)



Under the Waste Electrical and Electronic Equipment (WEEE) Directive and implementing regulations, when customers buy new electrical and electronic equipment from Tripp Lite they are entitled to:

- Send old equipment for recycling on a one-for-one, like-for-like basis (this varies depending on the country)
- Send the new equipment back for recycling when this ultimately becomes waste

Tripp Lite follows a policy of continuous improvement. Specifications are subject to change without notice.



1111 W. 35th Street, Chicago, IL 60609 USA • www.tripplite.com/support