

# *SunBriteTV*<sup>®</sup>

True Outdoor Television

## **SB-WM-F-M-BL / SB-WM-T-M-BL**

**Weatherproof Universal Fixed and Tilt Mounts  
For Medium Displays**



**INSTALLATION MANUAL**

## WARNINGS:

- Installation by a qualified professional is highly recommended for this product.
- Do not begin installation until you have thoroughly read and understand these instructions.
- This mount supports displays up to VESA 400X300, and a maximum load of 100 lbs (45.5 kg).
- Ensure the mounting wall will safely support four times the combined weight of the Mount and display panel.
- The manufacturer does not accept responsibility for incorrect installation.

## SPECIFICATIONS:



- Maximum Load: 100 lbs (45.5 kg)
- Forward Tilt Range: - 8° /+ 13°
- Horizontal Tilt Range: ±5°
- Dacromet Coated Assembly
- Stainless Steel Mounting Hardware

## TOOLS REQUIRED:

- Power Drill
- 5/16" and 1/4" Drill Bit
- Phillips Head Screw Driver
- Level
- Socket Wrench with 1/2" Socket head

## BOX CONTENTS:

- Wall Plate (1)
- Arm Left (1)
- Arm Right (1)

 **CAUTION:** This wall mount is intended for use only with the maximum weight of 100 lbs (41 kg). 

## HARDWARE KIT

### Bag 1

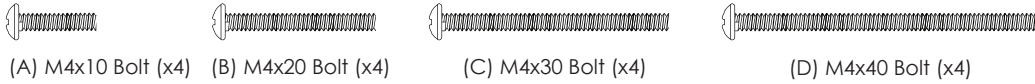

### Bag 2

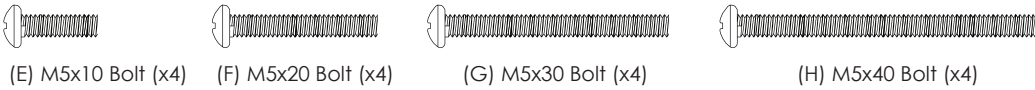

### Bag 3

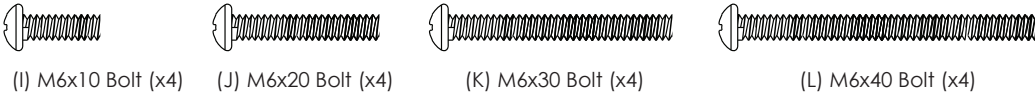

### Bag 4

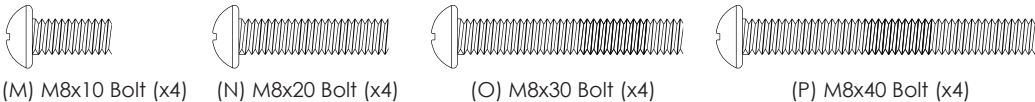

### Bag 5

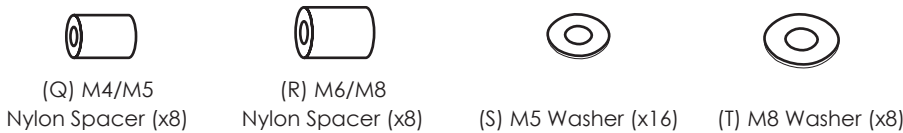

### Bag 6

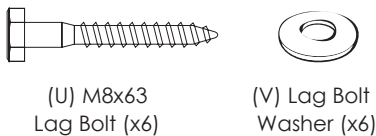

### Bag 7



## PACKAGE CONTENTS:

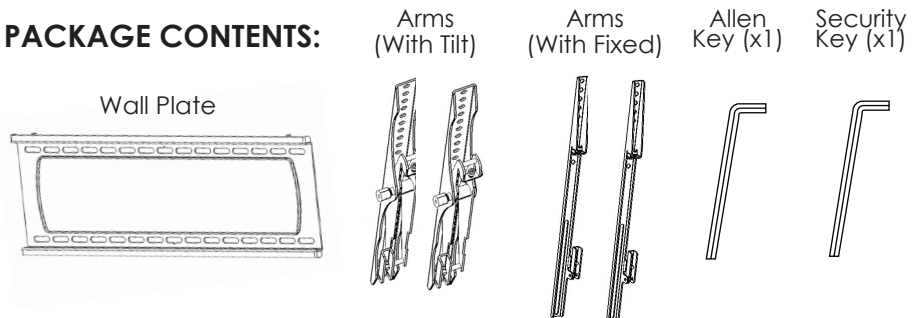

# INSTALLATION:

## Step 1: Mounting the Wall Bracket Assembly

### For Mounting on a Stud Wall

- Pre-drill holes into two wood studs using a 1/4" drill bit. Be sure to drill into the center of the studs at least 2-1/2" deep. The use of a stud finder is highly recommended.
- Insert four Lag Bolts (U) and washers (V) into holes through the Wall Plate and tighten down (Figure 1).

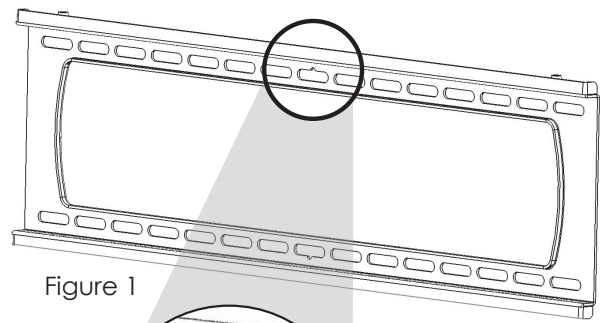
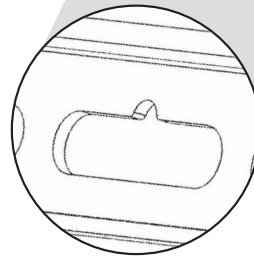

Figure 1



**TIP:** To assist in installation, the wall bracket features a screw slot for temporary hanging of the bracket.

**WARNING:** Tighten bolts so that wall plate is firmly attached, but do not overtighten. Overtightening can damage the bolts, greatly reducing their holding strength.

### For Mounting on a Concrete Wall

- Pre-drill holes into concrete using 5/16" drill bits to a depth of 2-1/2". Insert concrete wall anchors (W) and tap in with hammer, if necessary (Figures 2 & 3).

**WARNING:** When installing wall arm assembly on cinder block, verify first that you have a minimum of 1-3/8" of concrete thickness to be used for the concrete anchors. Do not drill into mortar joints! Be sure to mount in a solid part of the block, generally 1" minimum from the side of the block. Cinder block must meet ASTM C-90 specifications. It is suggested that a standard electric drill on slow setting is used to drill the hole instead of a hammer drill to avoid breaking out the back of the hole when entering a void or cavity.

**Concrete must be 2000 psi density minimum. Lighter density concrete may not hold concrete anchor.**

Make sure that the supporting surface will safely support the combined load of the equipment and all attached hardware and components.

- Insert four Lag Bolts (U) into the wall anchors through the Wall Plate. Tighten all bolts.

**WARNING:** Tighten bolts so that wall plate is firmly attached, but do not overtighten. Overtightening can damage the bolts, greatly reducing their holding strength.

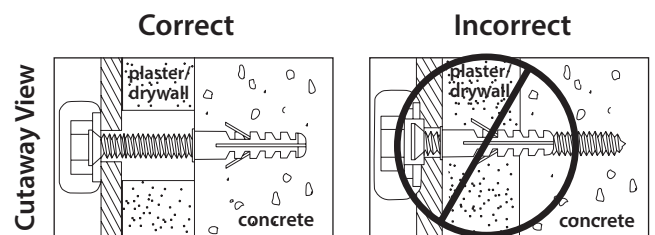

Figure 2

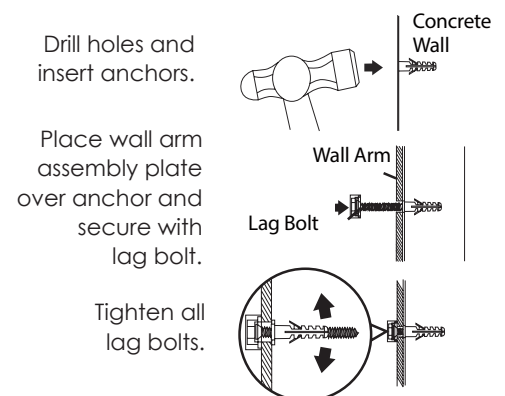

Figure 3

## Step 2: Mount Arms to TV

- Determine the diameter of the screw your TV requires by carefully trying to hand-thread one (A - P) into the threaded insert on the rear of the TV. If there is any resistance, stop immediately.
- Thread the screw through the washer (S or T), arm, spacer (Q or R), and into the TV.  
*Note: Spacers are commonly needed on TVs with curved backs or recessed screw inserts.*
- Ensure the arms are installed flat side to TV and are square to each other after all screws have been installed (Figure 4).

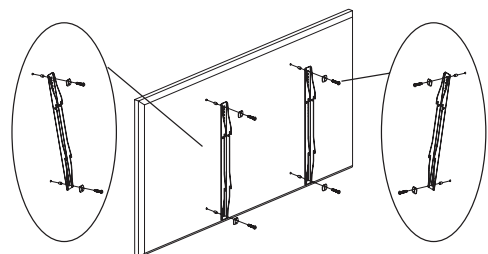

Figure 4

### Step 3: Hang TV on to the Wall Plate

- A. Carefully lift the TV to hook the arms over the top lip of the wall plate. Allow the lower portion of the arms to swivel in under the bottom lip of the wall plate. Do not release the TV until it is completely connected to the wall plate (Figure 5).

Figure 5



## ADJUSTMENTS:

### Adjust Horizontal Level and Tilt

#### Forward Tilt Adjustment (SB-WM-T-L-BL)

- A. Using the included long Allen key, loosen the tilt adjustment locks on the sides of the arms enough to allow movement.
- B. Set the tilt to the desired angle, then re-tighten the locks. If the locks cannot be tightened enough, remove the TV from the wall for better access.

Figure 6

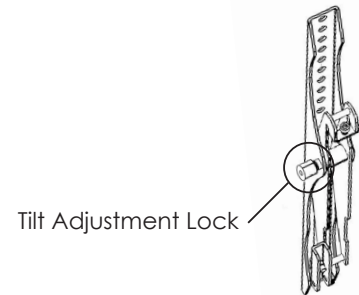

#### Horizontal Adjustment

- A. If display is not horizontally level when mounted, Tilt Adjustment Screws are included at the top of each arm for micro-adjustments (Figure 7). Use provided Allen Key to raise or lower the screw, which will in turn raise or lower the mount.

*Note: Due to display weight, it may be easier to lift panel slightly when adjusting the screw. Caution should be taken to avoid any slips or drops to avoid damage and/or injuries.*

Figure 7

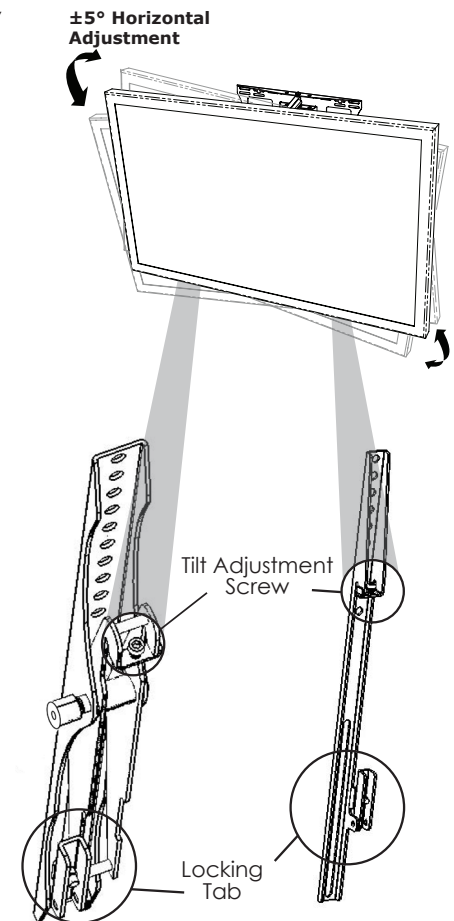

### Locking

- A. To lock the arms to the wall bracket, twist the locking tabs until the edge catches behind the bracket. The Allen Key can be used as a tool to help with this step. Padlock is optional (not included).

### Lifetime Limited Warranty

SunbriteTV™ Mounts have a Lifetime Limited Warranty. This warranty includes parts and labor repairs on all components found to be defective in material or workmanship under normal conditions of use. This warranty shall not apply to products which have been abused, modified or disassembled. Products to be repaired under this warranty must be returned to SunbriteTV or a designated service center with prior notification and an assigned return authorization (RA) number.

Technical Support 866.838.5052