



TH53

TwinPlex™ Omnidirectional Headset

The Shure Omnidirectional TwinPlex Headset, TH53, user guide.
Version: 4 (2019-I)

Table of Contents

TH53TwinPlex™ Omnidirectional Headset	3	Replacement Parts	9
General Description	3	Threaded Mount Instructions	10
Features	3	Wiring and Termination	10
Model Variations Key	4	Typical Wiring Table	11
Care and Maintenance	4	Converting LEMO to TA4F	12
Adjusting the Headband and Microphone	4	TA5F Wiring for Lectrosonics Bodypacks (Servo Biased Wiring)	12
Reversing the Boom	7	Hirose Wiring for Sony Bodypacks	13
Attaching the Windscreen	7	MTQG Connector Assembly	14
Using the Collar Clip	8	Specifications	14
Accessories	8	Frequency Response	16
		Certifications	16

TH53 TwinPlex™ Omnidirectional Headset

General Description

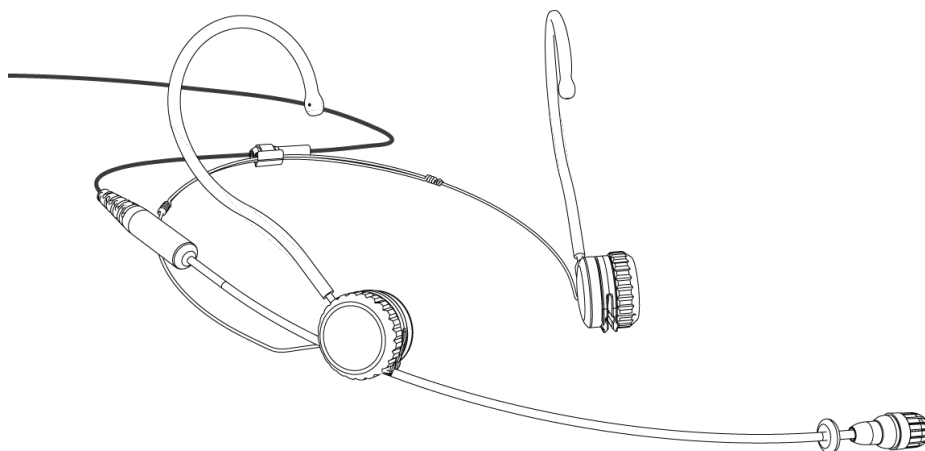

The Shure TwinPlex™ omnidirectional headset offers exceptional sound quality and the lightest, most comfortable fit for a variety of applications. The TwinPlex dual-diaphragm technology yields extraordinary, off-axis response, and low self-noise while delivering life-like, exceptional clarity and robust low frequency response, free of digital interference. The cable itself is ultra quiet and has been tested to be the longest-lasting, most dependable cable in its class. The innovative clutch system quickly allows adjustment of length and pitch of the boom arm for optimal placement and a stable fit while the ultralight frame virtually is weightless for extended comfort and wear.

The TwinPlex series features the most extensive accessories and connector options to date. TwinPlex not only meets premium market-leading expectations, they exceed them.

Features

- Exceptional sound quality from the all new TwinPlex dual-diaphragm element
 - Robust low frequency response with flat top end
 - Best in class specifications and dynamic range
- Durability beyond the competition
 - Exclusive, double helix cable technology with redundant grounding
 - Nano-coated, interchangeable frequency caps for reduced sweat out and moisture resistance
- Ultra lightweight, fully adjustable headset frame
 - Quickly adjust length and pitch of the boom arm without bending
 - Easily switch between left or right positioning
 - Comfort earhook sleeves allow for extended wear

- Headset frame can adjust down to the smallest child's head
- High RF immunity for use with today's digital wireless systems
- Paintable cables allow for discreet placement in professional theater applications
- Interchangeable frequency response caps offer adjustable flat or presence responses
- Available in a variety of color and connector offerings

Model Variations Key

TH53 T/O-MTQG
Color Polar Pattern Connector

Color: Black / Cocoa / Tan

Polar Pattern: Omnidirectional

Connector: LEMO / MTQG / MDOT / NC

Note: Not all model variations are available. Refer to www.shure.com/twinplex for the most up to date offerings.

Care and Maintenance

The TwinPlex lavalier dual-diaphragm has a nanocoating which rejects the build-up of grit from sweat and water. It is designed to withstand being blown out with a can of air for quick clean-up.

Adjusting the Headband and Microphone

① Adjust headband width

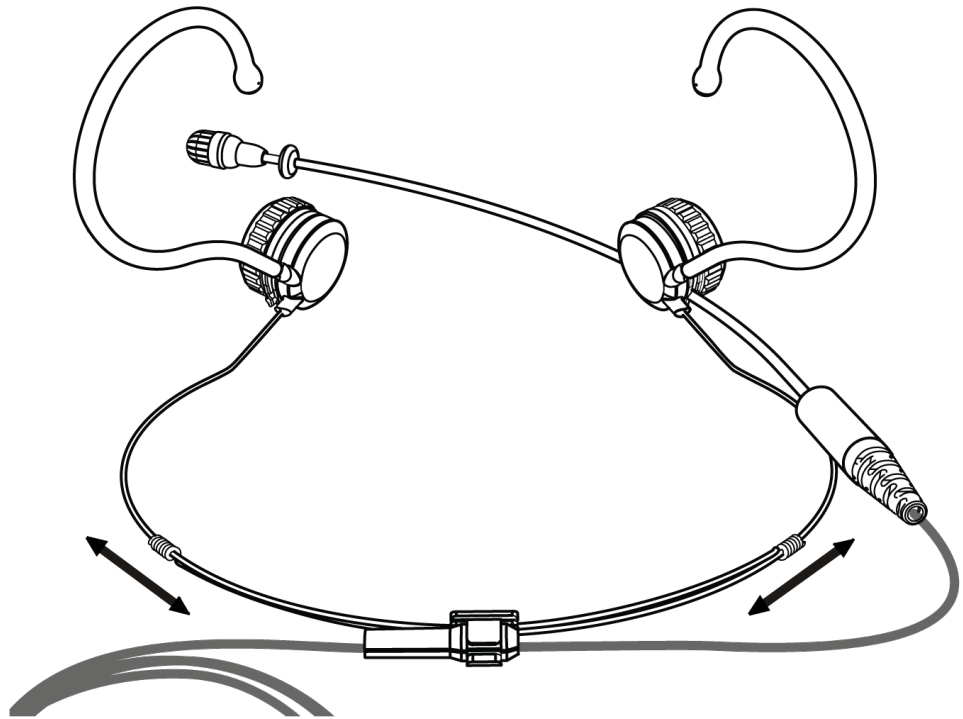

② Adjust the earhooks and boom angle

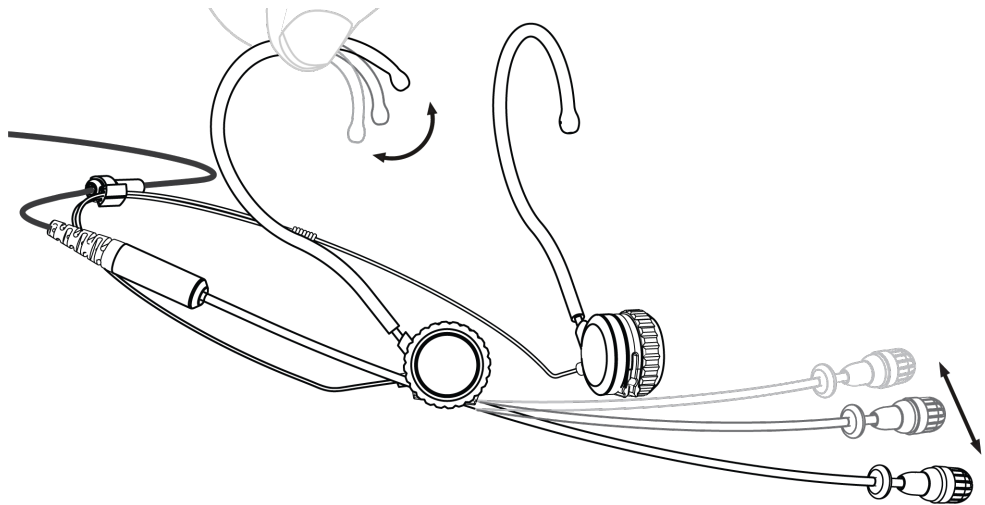

③ Unscrew the clutch to adjust boom height and length

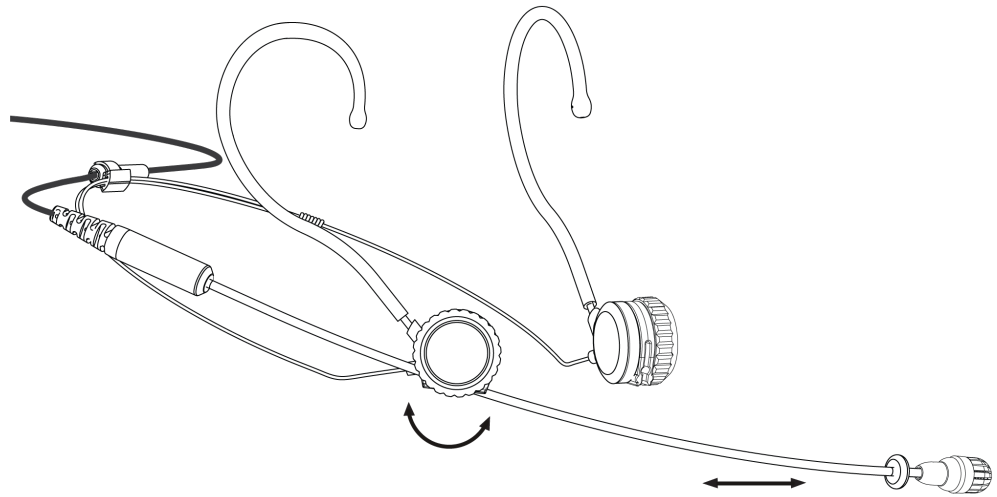

④ Bend boom arm into place. Adjust position

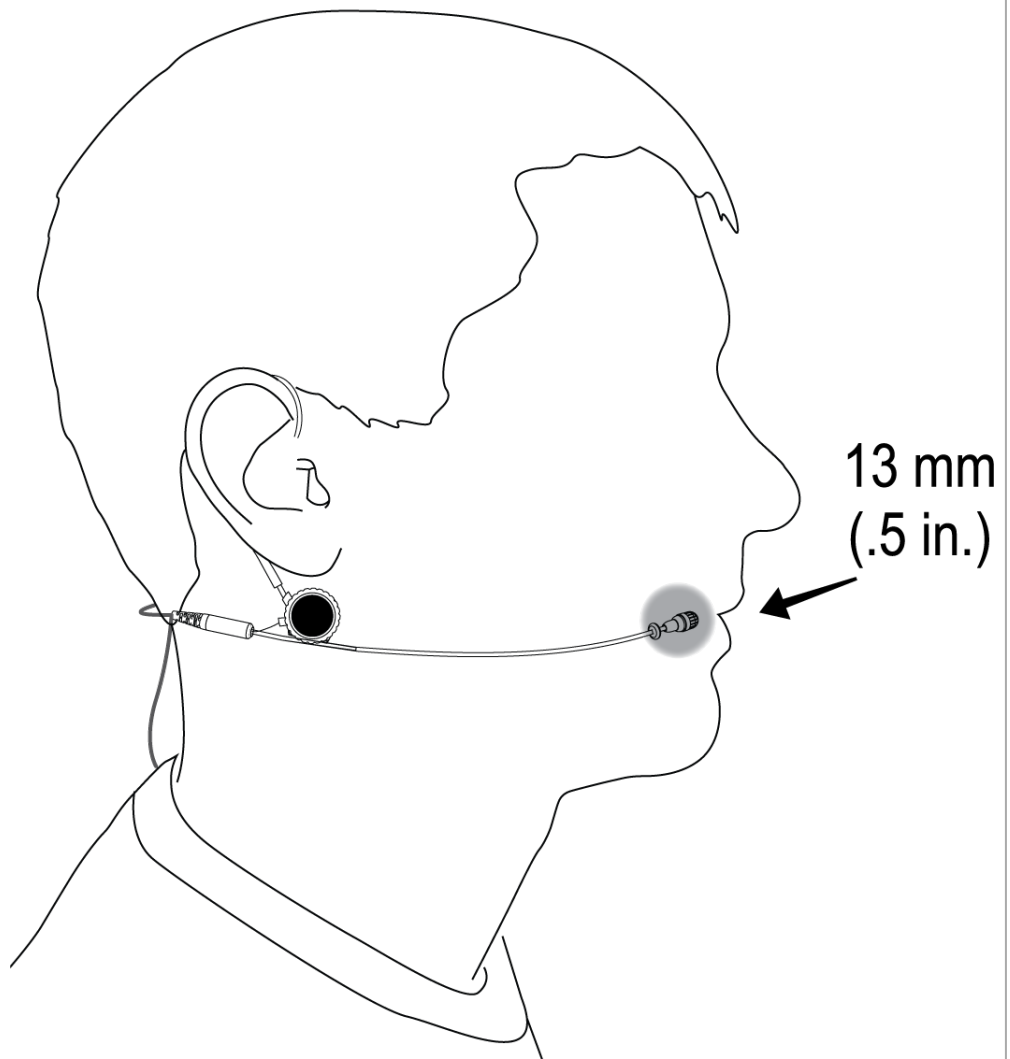

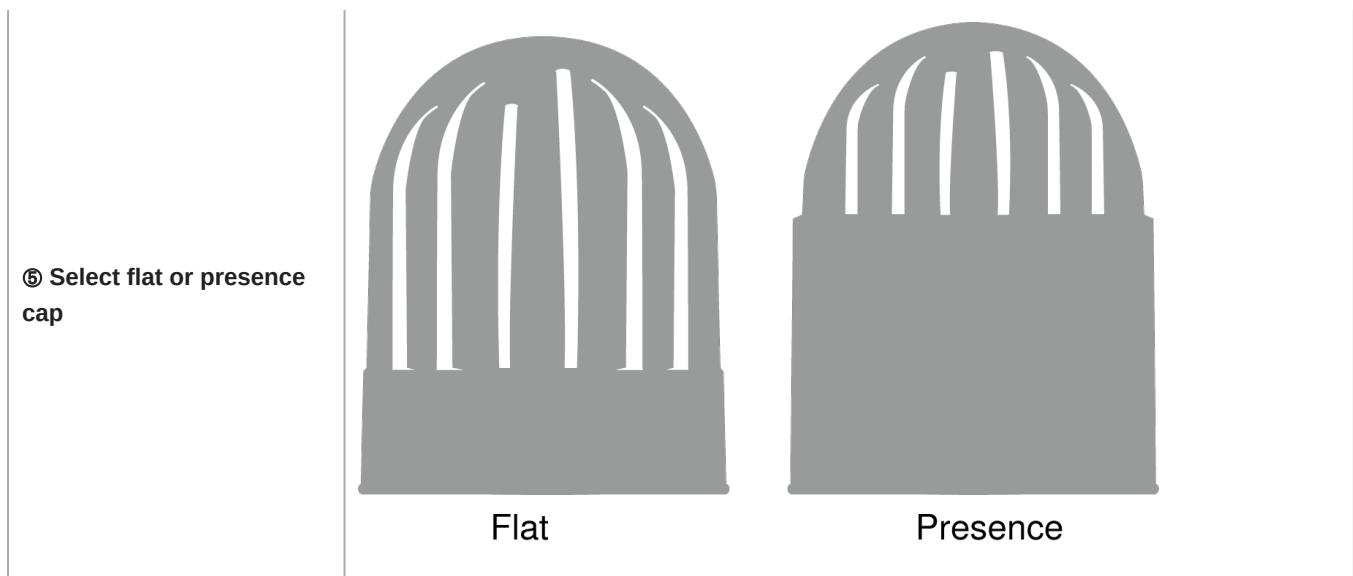

Reversing the Boom

The microphone boom can be positioned on the left or right side of the head.

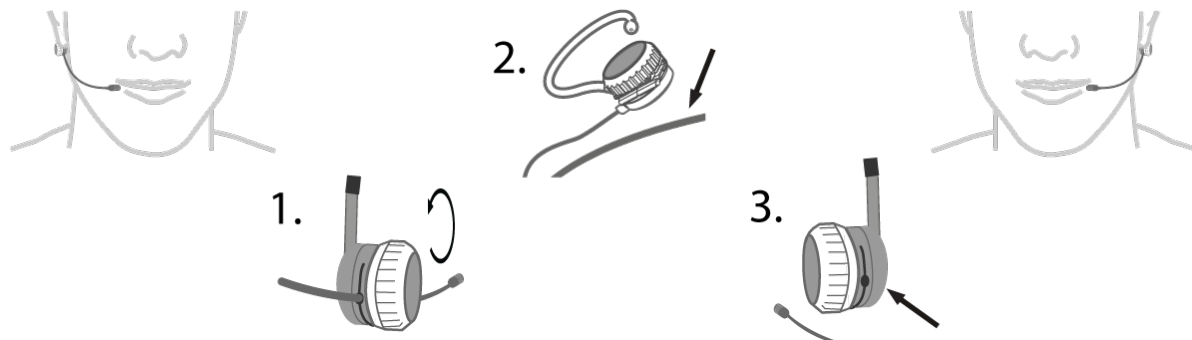

1. Unscrew the clutch to loosen the boom arm.
2. Push down and snap out the boom arm.
3. Snap into the other side and tighten in place.

Attaching the Windscreen

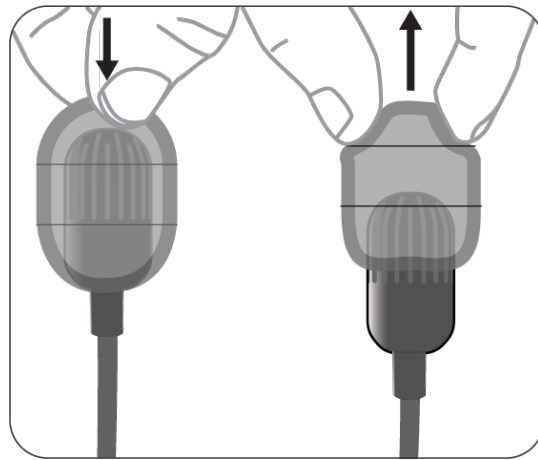

Using the Collar Clip

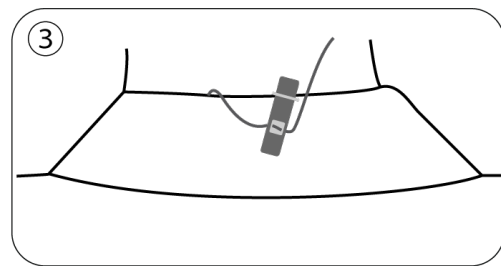
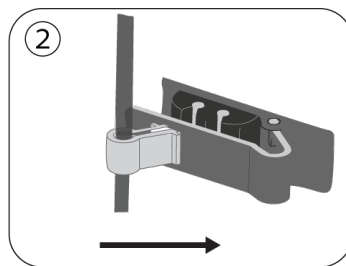
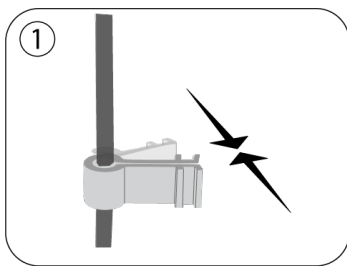

Accessories

Replacement Parts

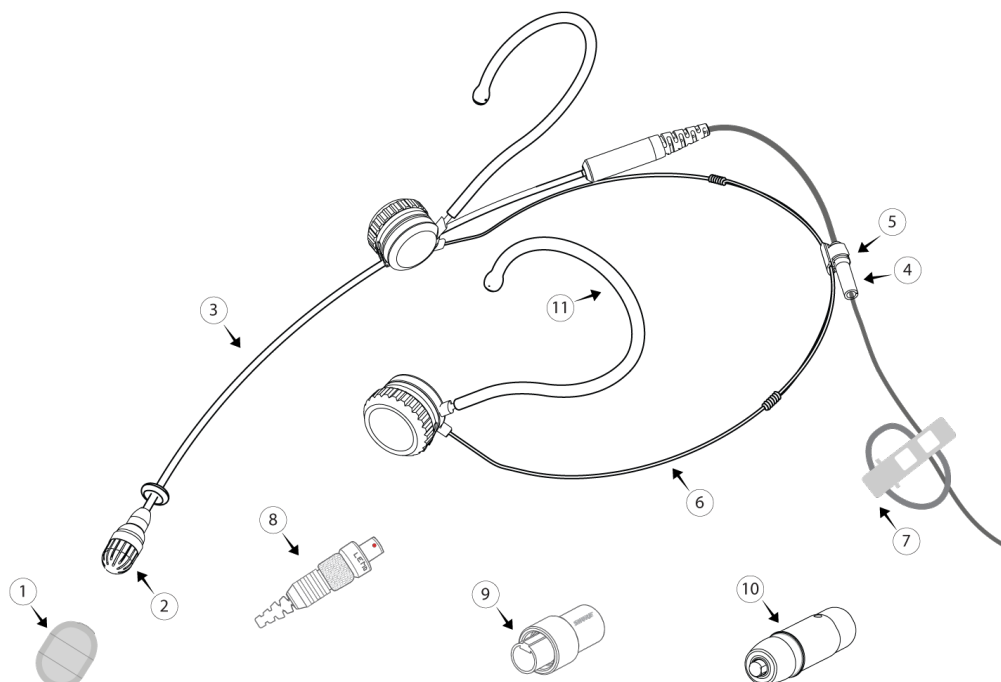

	Description	Black	Tan	Cocoa
1	Foam Windscreen	RPM40WS/B	RPM40WS/T	RPM40WS/C
2	Frequency Caps, Flat Response	RPM40FC/B	RPM40FC/T	RPM40FC/C
	Frequency Caps, Presence Response	RPM40PC/B	RPM40PC/T	RPM40PC/C
3	Microphone Boom Arm and Cable Assembly, Lemo Connector	RPM53B/O-LEMO	RPM53T/O-LEMO	RPM53C/O-LEMO
	Microphone Boom Arm and Cable Assembly, MTQG Connector	RPM53B/O-MTQG	RPM53T/O-MTQG	RPM53C/O-MTQG
	Microphone Boom Arm and Cable Assembly, No Connector	RPM53B/O-NC	RPM53T/O-NC	RPM53C/O-NC
	Microphone Boom Arm and Cable Assembly, MicroDot Connector	RPM53B/O-MDOT	RPM53T/O-MDOT	RPM53C/O-MDOT
4	Cable Flex	RPM53B-CF	RPM53T-CF	RPM53C-CF
5	Cable Headset Clip	RPM53B-CC	RPM53T-CC	RPM53C-CC

	Description	Black	Tan	Cocoa
6	Headset Frame	RPM53B-HF	RPM53T-HF	RPM53C-HF
7	Collar Clip	RPM40STC/ B (Black), RPM40STC/ W (White)	RPM40STC/ T	RPM40STC/ C
8	Connector	WA430 (MTQG), WA416 (LEMO)		
9	Threaded TA4F/MTQG Collar	WA445		
10	XLR Preamplifier	RPM400TQG (TA4F to XLR), RPM400LEMO (LEMO to XLR)		
11	Clear Earhook Sleeve	RPM50ES		
	Storage Case	RPM50CASE		

Threaded Mount Instructions

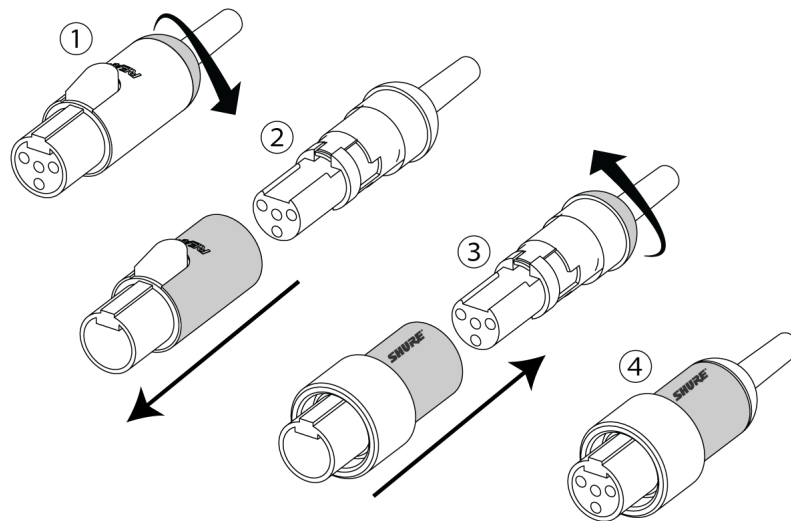

Wiring and Termination

Typical Wiring Table

Series	Cable Construction	Electrical Design	Polarity	Replacement Connector	For Use With	Wiring	Line Art (From Solder Side)
TH53-MTQG	1.6mm cable with 2 conductors, 2 shield wires and shield	3-Wire (Source Follower)	Positive with respect to ground	WA430	All Shure TA4F Bodypacks	Red wire: Bias(2) Blue wire: Audio(3) Shield wire: Ground(1) Shield: Ground (Shell)	
TH53-LEMO	1.6mm cable with 2 conductors, 2 shield wires and shield	2-Wire (Common Source)	Negative with respect to ground	WA416	Shure Lemo bodypacks (ADX1-Lemo, Shure UR1M-Lemo, ULXD1-Lemo), Sennheiser SK5212, Lectrosonics SSM, and others	Red wire: Audio/ Bias(3) Blue wire: Not connected Shield wire: Ground(1)	
TH53-NC	1.6mm cable with 2 conductors, 2 shield wires and shield	2-Wire (Common Source)	Negative with respect to ground	LEMO: WA416, Shure TQG/ TA4F: WA430, Lectrosonics TA5F: WA435	Termination Dependent	Red wire: Audio/Bias Blue wire: Not connected Shield wire: Ground Shield: Ground (Shell)	

Converting LEMO to TA4F

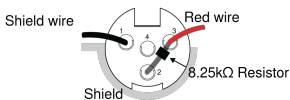
Series	Cable Construction	Electrical Design	Polarity	Replacement Connector	For Use With	Wiring	Line Art (From Solder Side)
TH53-LEMO	1.6mm cable with 2 conductors, 2 shield wires and shield	2-Wire (Common Source)	Negative with respect to ground	Shure TQG/TA4F: WA430	Termination Dependent	Shield wire: Ground(1) Red wire: Audio/Bias(3) Blue wire: Not connected 8.25kΩ Resistor between pin 2 and 3 Shield: Ground(Shell)	

TA5F Wiring for Lectrosonics Bodypacks (Servo Biased Wiring)

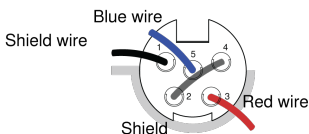
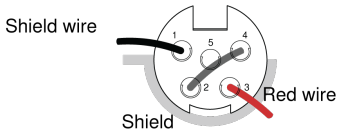
Series	Cable Construction	Electrical Design	Polarity	Replacement Connector	For Use With	Wiring	Line Art (From Solder Side)
TH53-MTQG	1.6mm cable with 2 conductors, 2 shield wires and shield	3-Wire (Source Follower)	Positive with respect to ground	WA435	Lectrosonics TA5F bodypacks	Red wire: Bias(3) Blue wire: Audio(5) Shield wire: Ground(1) Shield: Ground(Shell) Jumper between 2 and 4	
TH53-LEMO, TH53-NC	1.6mm cable with 2 conductors, 2 shield wires and shield	2-Wire (Common Source)	Negative with respect to ground	WA435	Lectrosonics TA5F bodypacks	Red wire: Audio/Bias(3) Blue wire: Not connected Shield wire: Ground(1) Shield: Ground(Shell) Jumper between 2 and 4	

Hirose Wiring for Sony Bodypacks

Notes:

- When using TwinPlex mics with Sony Hirose 4-pin bodypacks, Shure recommends purchasing Shure –MTQG versions and not –NC versions. This facilitates an easier termination due to the lack of circuitry required in Shure 3-wire/MTQG TA4F products.
- Due to the thin cable on TwinPlex and the large boot on Hirose connectors, heat shrink may be required to build up the cable under the boot where the crimp connection is made and where the cable exits the boot
- The TwinPlex Microdot (-MDOT) version can be used with 4-pin Hirose adapters from DPA (DPA part # DAD6008)

Series	Cable Construction	Electrical Design	Polarity	Replacement Connector	For Use With	Wiring	Line Art (From Solder Side)
TH53-LEMO TH53-NC	1.6mm cable with 2 conductors, 2 shield wires and shield	2-Wire (Common Source)	Negative with respect to ground	Hirose 4-pin-KMC-9BPD-4P	Sony Hirose Bodypacks (WRT)	Red wire: Audio/Bias: Into resistor and capacitor 1: 8.2k resistor 2: Jumper to 4 3: 1 uF capacitor (-) 4: Ground/shield-jumper to 2 Split Shield to shell Blue wire: not used	
TH53-MTQG	1.6mm cable with 2 conductors, 2 shield wires and shield	3-Wire (Source Follower)	Positive with respect to ground	Hirose 4-pin-KMC-9BPD-4P	Sony Hirose Bodypacks (WRT)	1: Red wire (Bias) 2: Blue wire (Audio) 3: Jumper to 4 4: Ground/shield-jumper to 3 Split Shield to shell	

MTQG Connector Assembly

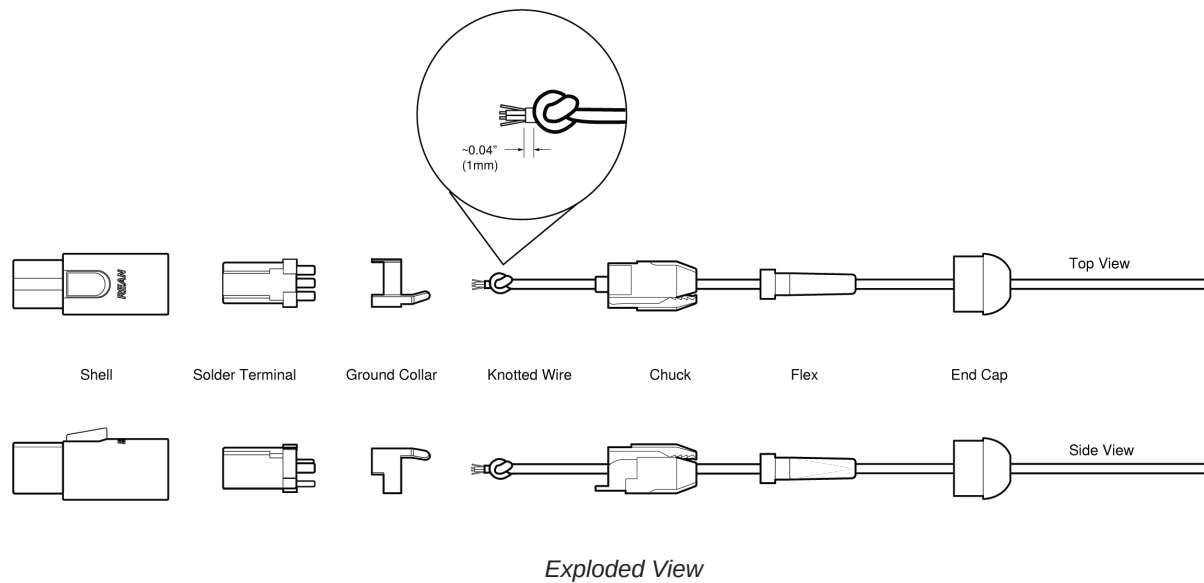

Note: Make sure to solder the shield to ground collar.

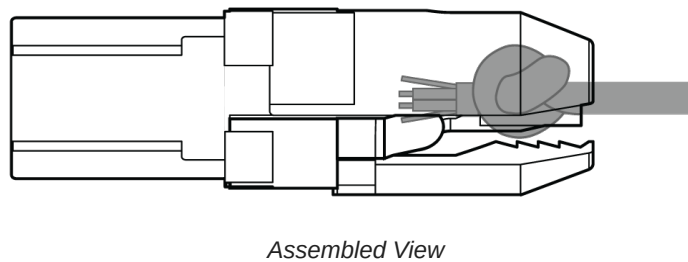

Specifications

All specification values are based on using a typical bodypack with 5 V bias input or the RPM400MTQG preamplifier. When using the RPM400LEMO amplifier, refer to the RPM400LEMO specifications. ^[1]

Microphone Capsule

Dual-Diaphragm, Prepolarized Condenser

Polar Pattern

Omnidirectional

Frequency Response

20 Hz to 20 kHz

Sensitivity

-45.0 dBV(5.62 mV)at 1 kHz ^[2]

Self-Noise, A-Weighted, Equivalent Acoustical

24.5 dB SPL-A

Signal-To-Noise Ratio ^[3]

69.5 dB

Output Clipping Level

3.0 dBV, 1 kHz at 1% THD, typical

Maximum SPL ^[4]

142.0 dB SPL, 1 kHz at 1% THD, typical

Dynamic Range

117.5 dB typical

Microphone Current Draw

120 to 240 μ A, typical

Bias Voltage

Recommended Operating Voltage

5 V DC

Housing

Molded ABS

Polarity

MTQG	Positive pressure on diaphragm produces positive voltage on pin 3 with respect to pin 1
LEMO, NC, MDOT	Positive pressure on diaphragm produces negative voltage on pin 3 with respect to pin 1.

Cable Diameter

1.6 mm

Cable Length

MTQG, LEMO, MDOT	66 in. (1.67 m)
NC	96 in. (2.43 m)

Net Weight

Boom arm with cable	12.0 g(0.42 oz.)
Headset frame	6.0 g(0.21 oz.)

^[1]All specifications measured with a 48 Vdc phantom power supply. The microphone operates at lower voltages, but with slightly decreased headroom and sensitivity.

^[2]1 Pa=94 dB SPL

^[3]S/N ratio is the difference between 94 dB SPL and equivalent SPL of self noise, A-weighted

^[4]THD of microphone preamplifier when applied input signal level is equivalent to cartridge output at specified SPL

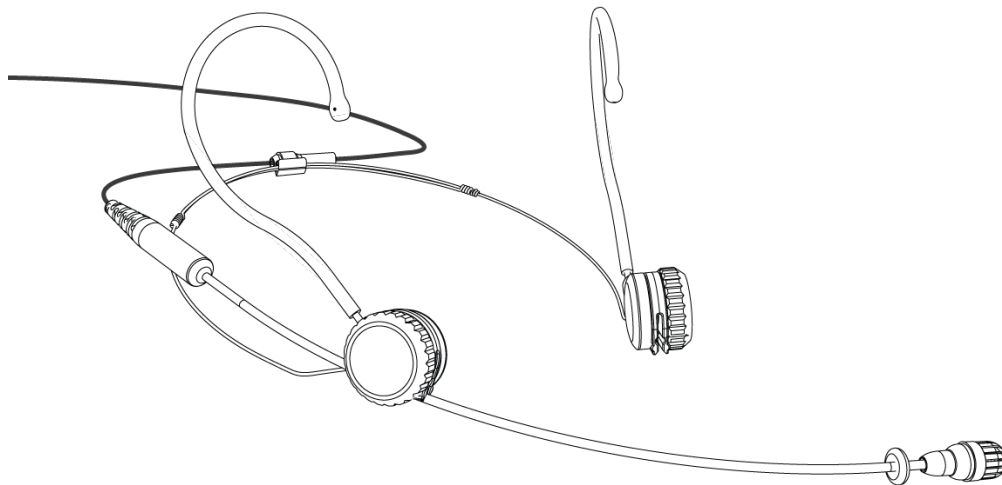

Dimensions

	A	B	C	D	E
	Cable Length	Cable Diameter	Microphone Length	Microphone Diameter	Boom Length
TH53-MTQG, TH53-MDOT, TH53-LEMO	66 in. (1.67M)	1.6MM	19MM	5.6MM	13.6CM
TH53-NC	96 in. (2.43M)	1.6MM	19MM	5.6MM	13.6CM

Frequency Response

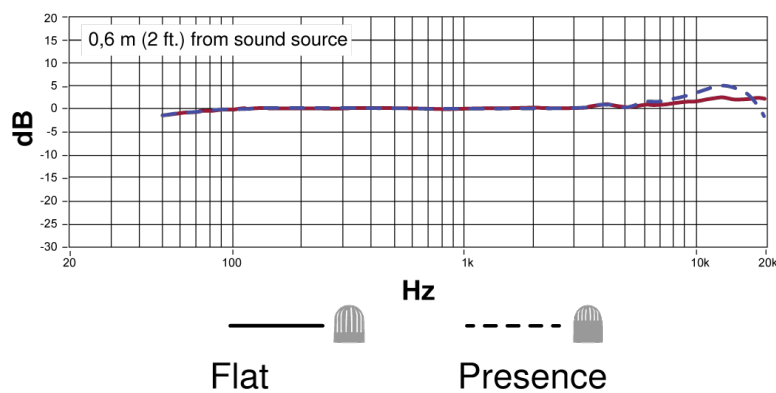

Certifications

This product meets the Essential Requirements of all relevant European directives and is eligible for CE marking.

The CE Declaration of Conformity can be obtained from: www.shure.com/europe/compliance

Authorized European representative:

Shure Europe GmbH

Headquarters Europe, Middle East & Africa

Department: EMEA Approval

Jakob-Dieffenbacher-Str. 12

75031 Eppingen, Germany

Phone: +49-7262-92 49 0

Fax: +49-7262-92 49 11 4

Email: info@shure.de