

DISHWASHER

MODEL : SDW6506JS



Dishwasher: Model SDW6506JS

CUSTOMER ASSISTANCE	2	GETTING STARTED	8-11
CONSUMER LIMITED WARRANTY	3	DISHWASHER CYCLE OPTIONS	12-13
IMPORTANT SAFETY INSTRUCTIONS	4	CARE AND CLEANING	14-15
APPEARANCE OVERVIEW	5	TROUBLESHOOTING	16-17
CONTROL PANEL	6	ERROR CODES	18
CONVENIENT FEATURES	7		

REGISTER YOUR PRODUCT

Registering your new product is easy and offers benefits that help you get the most out of your Sharp product including:

- ✓ **Convenience:** If you ever need warranty support, your product information is already on file.
- ✓ **Communication:** Stay up to date with important notifications and special offers from SHARP.
- ✓ **Support:** Quickly access support content including Owner's Manuals, FAQ's, How-to Videos, and much more.

3 EASY WAYS TO REGISTER TODAY!

 <p>SCAN Use the camera or QR code scanning application on your smart phone</p>	 <p>ONLINE Visit our sites to learn more about your product at sharpusa.com and sbl.sharpusa.com</p>	 <p>CALL US US 800-BE-SHARP 800-237-4277 Mon-Fri: 7am-7pm CST Sat-Sun: 9am-7pm CST</p>
Scan this QR Code on your smart phone	Visit http://www.sharpusa.com/register	Contact a Sharp Advisor on the phone

PRODUCT SUPPORT



If you have questions about the setup or operation of your product, please refer to the corresponding section within this manual.

Additionally, visit www.sharpusa.com/support to access exclusive content about your product including:

- FAQ's and How-To Videos
- Find or Request Service
- Purchase an Extended Warranty
- Downloads including the Installation Guide, Spec Sheet, and Owner's Manual

CONTACT US

If at any time you have questions or comments concerning your SHARP product, please contact the SHARP Customer Assistance Center. We are available to assist you through multiple contact methods for your convenience:

 <p>EMAIL Available 24/7 US: sharpusa.com</p>	 <p>CHAT ONLINE Mon-Fri: 7am-7pm CST Sat-Sun: 9am-7pm CST</p>	 <p>CALL US US 800-BE-SHARP 800-237-4277 Mon-Fri: 7am-7pm CST Sat-Sun: 9am-7pm CST</p>
See the Contact Us section on our sites	U.S. www.sharpusa.com/support	Contact a Sharp Advisor on the phone

SHARP®

CONSUMER LIMITED WARRANTY

SHARP ELECTRONICS CORPORATION (“Sharp”) warrants to the first consumer purchaser (“Purchaser”) that this Sharp brand product (the “Product”), when shipped in its original container, will be free from defective workmanship and materials, and agrees that it will, at its option, either repair the defect or replace the defective Product or part thereof with a new or remanufactured equivalent at no charge to the purchaser for parts or labor for the period(s) set forth below.

This warranty does not apply to any cosmetic or appearance items of the Product nor to the additional excluded item(s) set forth below nor to any Product the exterior of which has been damaged or defaced, which has been subjected to misuse, abnormal service or handling, or which has been altered or modified in design or construction. In order to enforce the rights under this limited warranty, the purchaser should follow the steps set forth below and provide proof of purchase to the servicer.

The limited warranty described herein is in addition to whatever implied warranties may be granted to purchasers by law. ALL IMPLIED WARRANTIES INCLUDING THE WARRANTIES OF MERCHANTABILITY AND FITNESS FOR USE ARE LIMITED TO THE PERIOD(S) FROM THE DATE OF PURCHASE SET FORTH BELOW. Some states do not allow limitations on how long an implied warranty lasts, so the above limitation may not apply to you.

Neither the sales personnel of the seller nor any other person is authorized to make any warranties other than those described herein, or to extend the duration of any warranties beyond the time period described above on behalf of Sharp. The warranties described herein shall be the sole and exclusive warranties granted by Sharp and shall be the sole and exclusive remedy available to the purchaser. Correction of defects, in the manner and for the period of time described herein, shall constitute complete fulfillment of all liabilities and responsibilities of Sharp to the purchaser with respect to the Product, and shall constitute full satisfaction of all claims, whether based on contract, negligence, strict liability or otherwise. In no event shall Sharp be liable, or in any way responsible, for any damages or defects in the Product which were caused by repairs or attempted repairs performed by anyone other than an authorized servicer. Nor shall Sharp be liable or in any way responsible for any incident or consequential economic or property damage. Some states do not allow the exclusion of incidental or consequential damages, so the above exclusion may not apply to you.

THIS WARRANTY GIVES YOU SPECIFIC LEGAL RIGHTS.

YOU MAY ALSO HAVE OTHER RIGHTS WHICH VARY FROM STATE TO STATE.

Your product model number & description	Model # SDW6506JS Dishwasher. (Be sure to have this information available when you need service for your Product.)
Warranty period for this product:	One (1) year parts and labor, including in-home service. Five (5) year parts only, racks and electronic controls.
Additional item(s) excluded from warranty coverage:	Commercial, non-residential, or use inconsistent with published installation and product operational instructions. In home instruction on how to use your product.
What to do to obtain service:	In-home service is provided for one year from date of purchase. Service can be arranged by calling 1-800-BE-SHARP. Be sure to have Proof of Purchase, Model, and Serial Number available.

TO OBTAIN SUPPLY, ACCESSORY OR PRODUCT INFORMATION, CALL 1-800-BE-SHARP or visit www.sharppusa.com.
SAVE THE PROOF OF PURCHASE AS IT IS NEEDED SHOULD YOUR DISHWASHER EVER REQUIRE WARRANTY SERVICE.

IMPORTANT SAFETY INSTRUCTIONS

⚠WARNING Follow the information in this manual to minimize the risk of fire, explosion, electric shock and to help prevent property damage or personal injury.

PROPER INSTALLATION

Install the dishwasher properly, as instructed in the included installation guide.

- 1 Water supply inlet temperature should be between 120°F and 149°F.
- 2 Dispose of the discarded appliance and packing material properly.
- 3 The dishwasher must be properly grounded to reduce the risk of electrical shock.
- 4 If there is any damage to the new dishwasher, contact the dealer. Do not attempt to repair or replace any part yourself.

WARNING

The manual does not cover every possible condition and situation that may occur.

- 1 Read all instructions before using the dishwasher.
- 2 Use the dishwasher only for intended function as described in this manual.
- 3 Use only detergents or rinse agents recommended for use in a dishwasher and keep them out of the reach of children.
- 4 When loading items to be washed:
 - Load sharp items and knives so that they are not likely to damage the door seal and tub.
 - Load sharp items and knives with the handles up to reduce the risk of injury.
- 5 Do not wash plastic items unless they are marked dishwasher safe. If not marked, check with manufacturer for recommendation. Items that are not dishwasher safe may melt and create a potential fire hazard.

- 6 If the dishwasher drains into a food disposer, make sure disposer is completely empty before running dishwasher.
- 7 Do not tamper with controls.
- 8 Do not operate the dishwasher unless all enclosure panels are in the proper place.
- 9 Do not touch the heating element during or immediately after use, especially if the sanitize option has been selected.
- 10 To reduce the risk of injury, do not allow children to play in or on a dishwasher.
- 11 Do not let children abuse, sit or stand on door or racks of the dishwasher.
- 12 Keep young children and infants away from dishwasher when it is in operation.
- 13 Under certain conditions, hydrogen gas may be produced in a hot water system that has not been used for two weeks or longer. **HYDROGEN GAS IS EXPLOSIVE.** If the hot water system has not been used for such a period, **BEFORE USING DISHWASHER**, turn on all hot water faucets and let water run from each for several minutes. This will release any accumulated hydrogen gas. Hydrogen gas is flammable. **DO NOT** smoke or use an open flame during this time.
- 14 Do not store or use combustible materials, gasoline or other flammable vapors and liquids in the vicinity of this or any other appliance.
- 15 Do not use the dishwasher if it has a damaged power line or plug, and do not plug the dishwasher into a damaged outlet. Failure to observe these instructions may result in electric shock.
- 16 Remove the door to the washing compartment when removing an old dishwasher from service or discarding it.

STATE OF CALIFORNIA PROPOSITION 65 WARNINGS

⚠WARNING Cancer and Reproductive Harm -

www.P65Warnings.ca.gov

SAVE THESE INSTRUCTIONS

APPEARANCE OVERVIEW

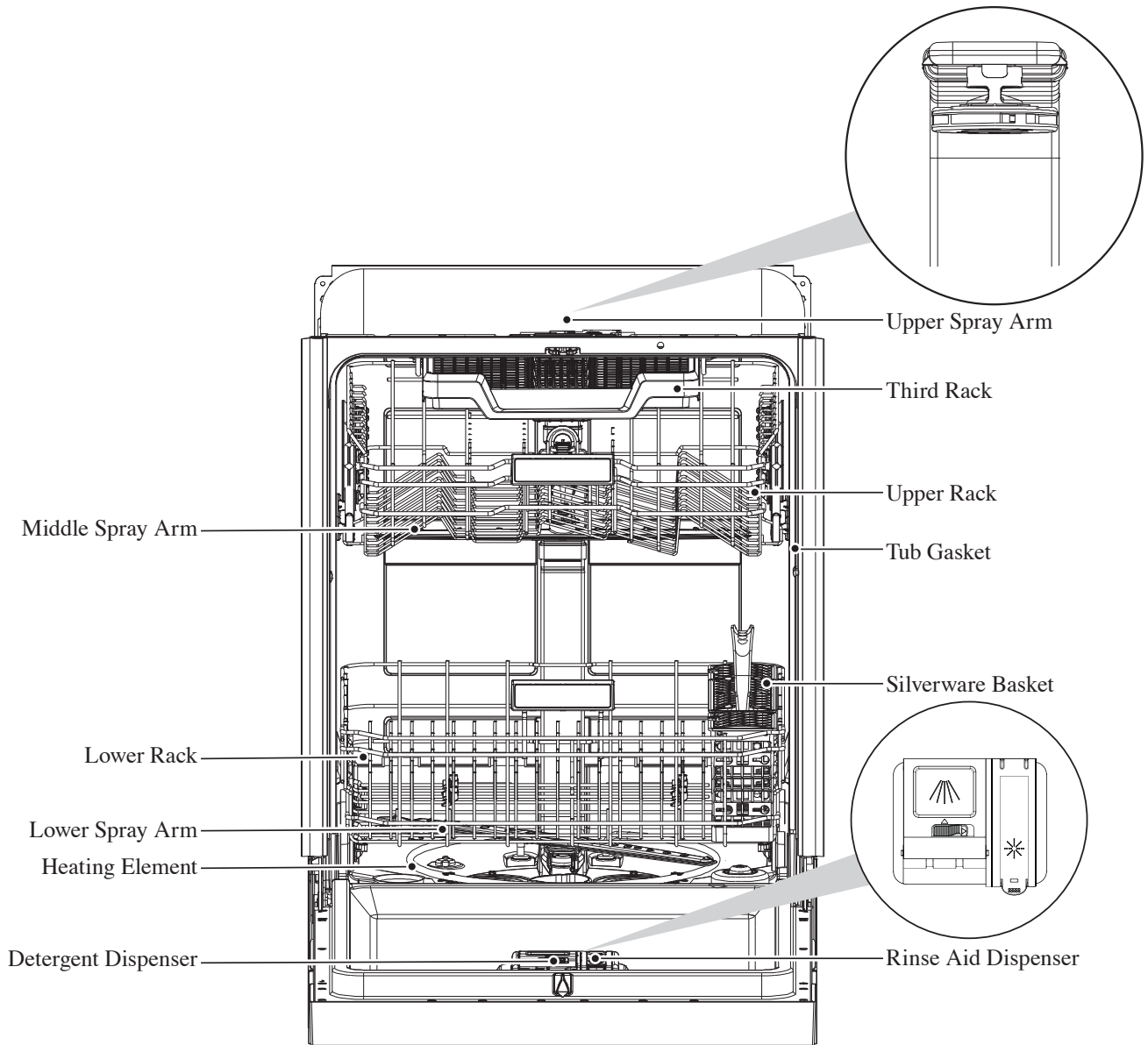

SPECIFICATION

Capacity	12 place settings
Dimension (W x H x D)	23 ⁵ / ₈ " x 33 ⁵ / ₈ " x 22 ³ / ₄ "
Weight Unpacked	70.55 lb
Power Supply	120 volts, 60 Hz
Rated Power Usage	Wash motor 50 W / Heater 840 W
Water Feed Pressure	20 ~ 80 psi (138 ~ 552 kPa)

CONTROL PANEL

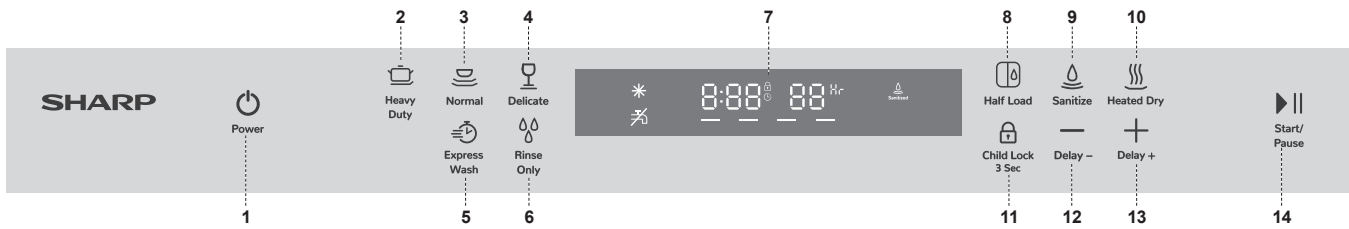

OPERATIONS (BUTTON)

1 Power

Press this button to turn on or turn off the dishwasher.

2 Heavy Duty

Heavy Duty cycle is for pots, pans, casseroles and dinnerware with dried-on or baked on soil.

3 Normal

Normal cycle with Heated Dry will completely wash and dry a full load of normally soiled dishes.

4 Delicate

Delicate cycle is for items that need special care such as stemware or porcelain.

5 Express Wash

Express Wash cycle is for lightly soiled or well-rinsed dish loads.

6 Rinse Only

Use for pre-rinsing dishes or glasses. This is only a rinse that keeps food from drying on your dishes and reduces odor buildup in your dishwasher until you are ready to wash a full load.

7 Screen Features

	To show the remaining program time and error code etc.
	To show the delay time.
	To roughly show the progress of program operation.
	Rinse Aid If the icon is lit, the dishwasher is low on dishwasher rinse aid and requires a refill.
	Water Faucet If the icon is lit, the water faucet closed.
	Child Lock If the indicator is lit, the child lock is on.
	The Sanitized indicator light illuminates when the cycle using the Sanitize option is finished. The light turns off when the door is opened or any button is pressed.

8 Half Load

When the load is about or less than half a typical load, use the Half Load function, which washes and dries with less water and energy.

9 Sanitize

Sanitize function is to sanitize dishes and glassware and maintains the water temperature at 156.2°F (69°C). This function is available with Heavy Duty, Normal, Delicate or Express Wash cycles.

10 Heated Dry

Heated Dry option is for heat-drying dishes. Heated Dry is not available for Rinse Only cycles.

11 Child Lock

Press this button to lock all controls and prevent children from accidentally interacting with controls or settings.

12 Delay -

Press the - button to decrease the delay time.

13 Delay +

Press the + button to add the delay time. Maximum 24 hours delay can be selected

14 Start/Pause

Once the door is firmly closed, press **Start/Pause** to start operation after selecting the cycle and options or delay time settings.

If the cycle needed to pause while a washing cycle in process, follow the steps below.

1. Open the door slightly and wait for a few seconds until the washing cycle stops.
2. Open the door to add or remove items.
3. Close the door, and then press **Start/Pause**.

The washing cycle will automatically resume.

IMPORTANT: Open the door slightly and wait for the spray arms and washing cycle to stop before opening the door completely. This will help from being splashed with hot water.

To cancel a washing cycle when the dishwasher is running, press and hold **Start/Pause** for 3 seconds.

CONVENIENT FEATURES

ADJUSTABLE UPPER RACK

The adjustable upper rack feature allows you to load taller items in either the upper or lower rack.

The upper rack can be adjusted 2" (5.08 cm).

Adjusting the clearance of the upper rack increases or decreases the clearance of the lower rack, as shown.

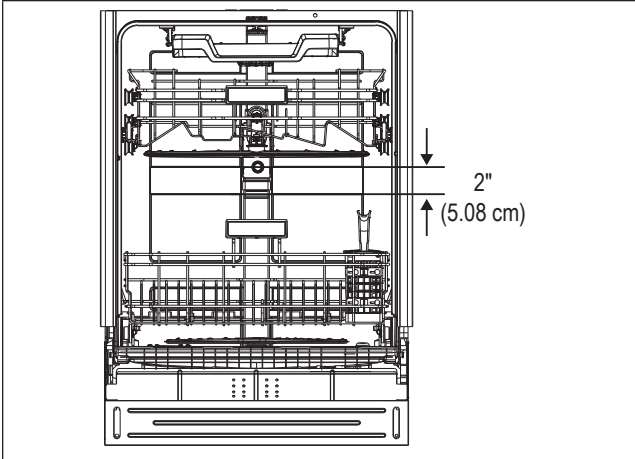

The upper dishwasher rack is designed for cups, glasses, small plates, bowls and plastic items marked dishwasher safe.

The upper rack can be easily adjusted 2" (5 cm) up or down to accommodate taller items in either in the upper or lower rack.

IMPORTANT:

- Remove all items before adjusting the rack. The rack must be empty.

To adjust the height of the upper rack, follow these steps:

<p>1 Pull out the upper basket.</p> A diagram showing the upper basket being pulled out from the dishwasher. An arrow points to the right, indicating the direction of movement.	<p>2 Pull up on upper basket to remove.</p> A diagram showing the upper basket being lifted upwards. An arrow points upwards, indicating the direction of movement.
<p>3 Re-attach the upper basket to upper or lower rollers.</p> A diagram showing the upper basket being pushed back into the dishwasher. An arrow points to the left, indicating the direction of movement.	<p>4 Push in the upper basket.</p> A diagram showing the upper basket being pushed into the dishwasher. An arrow points to the right, indicating the direction of movement.

FOLDABLE TINES

The fold-down tines in the lower rack make it easier to load extra large or hard-to-fit items such as serving bowls and roasters. The tines may be left in the up position for normal use or folded down for more flexible loading.

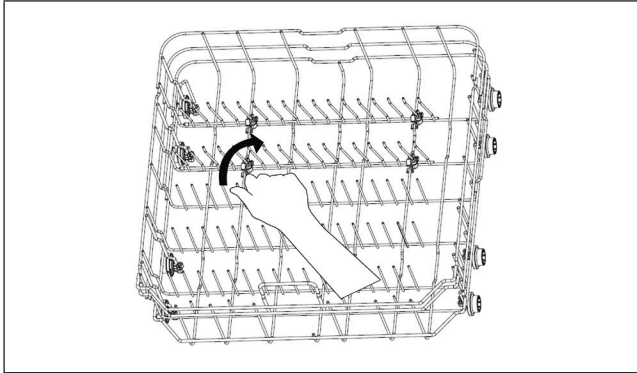

SMART WASH SYSTEM

Your dishwasher has Smart Wash System. This system can determine the type of cycle required to clean the dishes in the load with maximum efficiency. When a partial load of lightly soiled dishes is placed in the unit, a wash cycle similar to Express Wash will automatically be performed. When a full load of heavily soiled dishes is placed in the unit, Heavy Duty cycle will automatically be performed.

FILTER SYSTEM

Your dishwasher has a multiple filter system, which helps your dishwasher perform better using less water and less energy.

The filter system includes three filters that work in combination to separate dirty and clean water into different chambers.

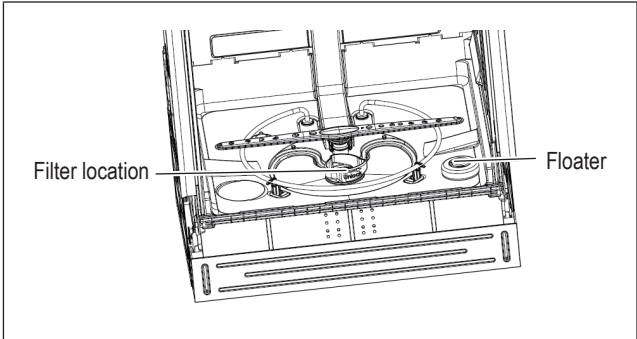

FLOATER PROTECTION SYSTEM

If the water level in the tub is too high, the floater protection will be triggered, the inlet valve will be closed and the drainage valve will be activated to drain until the tub water level is normal.

GETTING STARTED

HOW YOUR DISHWASHER CLEANS

Your dishwasher cleans by spraying a mixture of hot water and detergent through the spray arms against soiled surfaces.

The dishwasher fills with water, covering the filter area. Water is then pumped through the multiple filter system and spray arms. Separated soil particles go down the drain as the water is pumped out and replaced with clean water.

The number of water fills will vary with the cycle being used.

BASIC OPERATIONS

- 1 Prepare and load dishes into the dishwasher.
- 2 Add detergent and, if needed, rinse aid.
- 3 Close the door firmly to latch.
- 4 Select the cycle. Press the corresponding button, and the cycle icon will be lit.
- 5 Select the options. Press the corresponding button, and the option icon will be lit.
- 6 To start, press the **Start/Pause** button.

Your selections will only be activated when the door is firmly closed.

Check and clean the filters regularly for best performance.

NOTE

The dishwasher is programmed to remember your last cycle so you do not have to reset each time. To start the dishwasher using the same cycle and options selected on the previous wash, simply press the **Start/Pause** button.

DISH PREPARATION

Scrape away large pieces of food, bones, pits, toothpicks, etc. The continuous filtered wash system will remove the remaining food particles. Burned-on foods should be loosened before loading. Empty liquids from glasses and cups.

Foods such as mustard, mayonnaise, vinegar, lemon juice and tomato-based products may cause discoloration of stainless steel and plastics if allowed to sit for a long period of time. If not operating the dishwasher immediately, it is best to rinse off dishes soiled with these types of foods.

If the dishwasher drains into a food disposer, be sure disposer is completely empty before starting dishwasher.

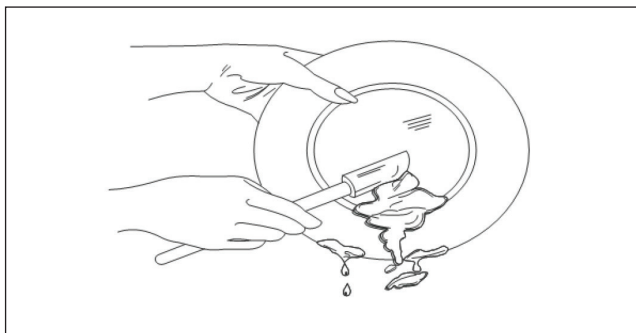

LOADING THE UPPER RACK

The features on your dishwasher rack may vary from the drawings shown.

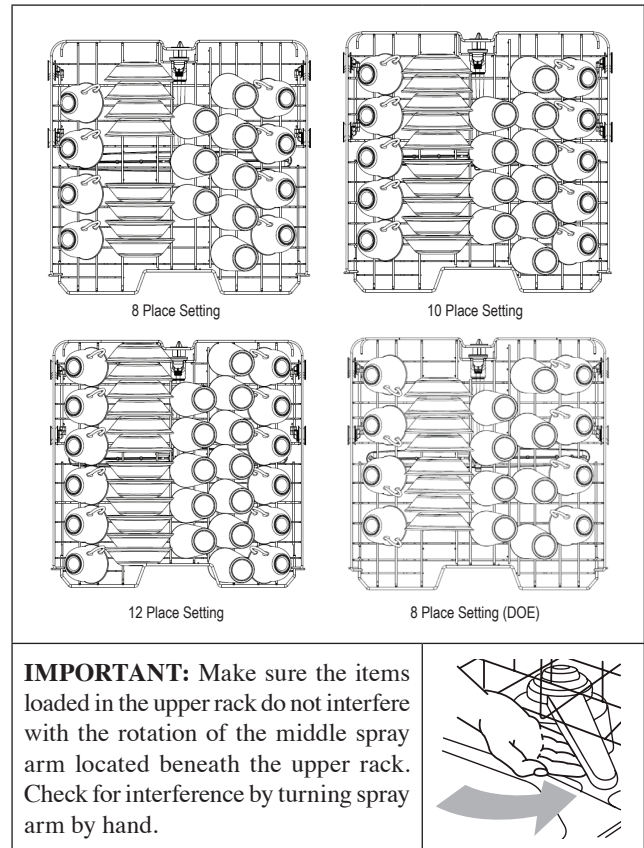

- Place items so the open ends face downward for cleaning and draining.
- Load glasses and cups in upper rack only. The lower rack is not designed for glasses and cups. Damage can occur.
- Place cups and glasses in the rows between tines. Placing them over the tines can lead to breakage, water spots and poor cleaning.
- Small bowls, pans and other utensils can be placed in the top rack. Load bowls in the center section for best stability.
- China, crystal and other delicate items must not touch each other during dishwasher operation. Damage may occur.
- Load plastic items so the force of the spray does not move them during the cycle.

GETTING STARTED

LOADING THE LOWER RACK

The lower rack is designed for plates, soup bowls, cookware and bakeware.

The adjustable upper rack allows you to load items up to 12.6" in height in the lower rack.

IMPORTANT: Items in the lower rack must be placed so that they do not interfere with the rotation of the spray arms, block the water inlet or keep the water spray from reaching the detergent dispenser.

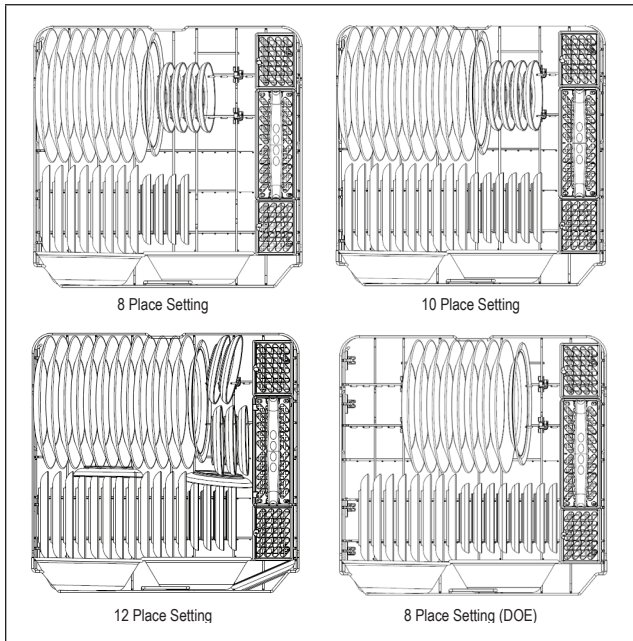

LOADING THE MINI THIRD RACK

You can place the items in the cutlery rack randomly or in an orderly fashion. The image below shows how to load the top rack for 12 place settings:

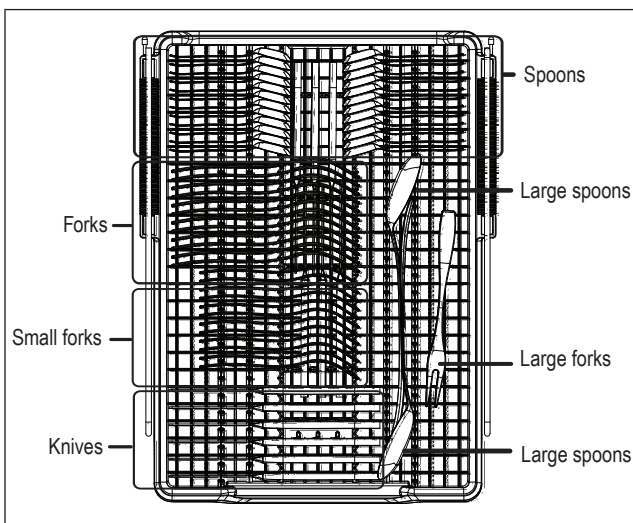

LOADING THE SILVERWARE BASKET

The silverware basket has three separate sections. For optimum loading flexibility, the center section of the basket can be used individually, joined with one or both side sections or removed.

- Lift handle to remove the silverware basket and set the basket on a counter or table top.
- Lift up on each side section to disengage the center section from the keyhole slots in the side sections.
- Load the silverware into the basket sections when the basket is in the lower rack or on a countertop.

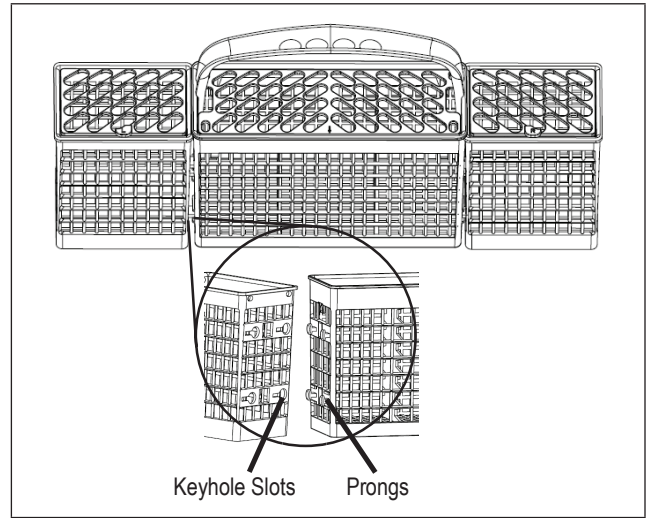

The three separated modules of the silverware basket can be used in both Upper and Lower Racks.

- | | | |
|----------|---------------|----------------|
| 1 Spoons | 3 Salad forks | 5 Large spoons |
| 2 Knives | 4 Forks | 6 Large forks |

CAUTION

- Do not let any item extend through bottom.
- Be sure nothing protrudes through bottom of the silverware basket or rack that could block the lower spray arm.
- Always load sharp items (knives, skewers, etc.) pointing down.



FOR BEST RESULTS

- To avoid injury, load utensils such as knives and skewers with handles pointing up and sharp metal edges pointing down. Items such as forks and spoons may be loaded with handles pointing up or down, using separators to prevent the edges of the silverware from nesting.
- Place small items such as baby bottle caps, jar lids, corncob holders, etc. in the basket sections with hinged covers. Close the covers to hold small items in place.

GETTING STARTED

- Unload or remove the baskets before unloading the racks to avoid water drops from falling on the silverware.
- When handles are up, mix items in each section of the baskets with some pointing up and some down to avoid nesting. Spray cannot reach nested items.

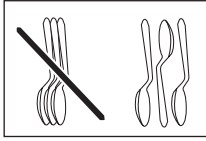

ADDING A DISH

To add or remove items after wash cycle starts:

- 1 Open door slightly and wait a few seconds until wash action stops before completely opening.
- 2 Add the item.
- 3 Close the door firmly to latch.
- 4 Press the **Start/Pause** button.

CAUTION TO AVOID BURN INJURY: Slightly open door and wait until spray arms and wash action stop. Hot steam may exit the dishwasher or hot water may splash out of it. Failure to **USE CAUTION** may result in injury.

ADD DETERGENT

IMPORTANT:

- Use automatic dish washing detergent only. Other detergents can produce excessive suds that can overflow out of the dishwasher and reduce washing performance.
- Add detergent just before starting a cycle.
- Store detergent tightly closed in a cool, dry place. Fresh automatic dishwasher detergent results in better cleaning.

DETERGENT DISPENSER

- 1 Push the dispenser cover release catch to open the main wash detergent compartment.

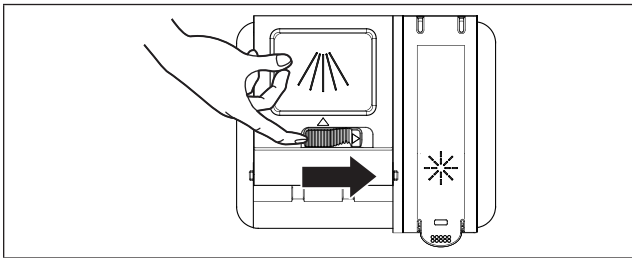

NOTE: The flap is always open at the end of a dishwashing cycle.

- 2 Add the recommended amount of detergent to the detergent compartment.

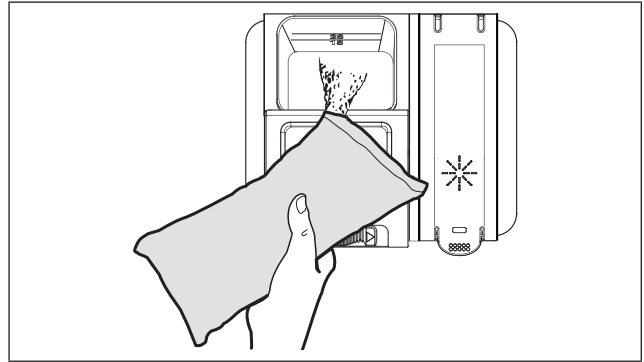

- 3 Press down on the top of the cover to secure.

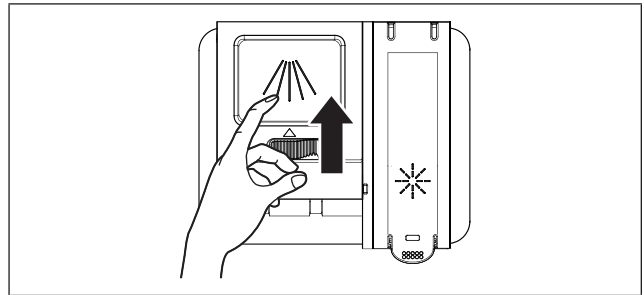

HOW MUCH DETERGENT TO USE

The amount of detergent to use depends on the soil level of your load, the type of detergent used and the hardness of your water.

- If you use too little detergent, dishes won't be clean.
- If you have soft water and use too much detergent, glassware will etch.

WATER HARDNESS

Water hardness varies depending on your water source. For the best results, your dishwasher is designed to operate with water that has a hardness of no more than 7 grains per gallon. Test kits are available from all major appliance parts retail outlets. If your water has a hardness over 8 grains per gallon, you may consider installing a water softener or regularly use an additive to enhance the performance of your detergent.

GETTING STARTED

FILLING THE RINSE AID

Rinse aid greatly improves drying and reduces water spots and filming. Without rinse aid, your dishes and dishwasher interior will have excessive moisture. The Heated Dry option will not perform as well without rinse aid. The Rinse Aid Dispenser, located next to the detergent dispenser, automatically releases a measured amount of rinse aid during the final rinse.

If spotting and poor drying are a problem, increase the amount of rinse aid dispensed by rotating the dial to a higher number. The dial is located under the dispenser cap.

If the rinse aid is low, the rinse aid light is illuminated at the beginning and end of the cycle indicating that it is time to refill.

Do not use a solid or bar-type rinse aid. Under normal conditions, the rinse aid will last approximately one month. Try to keep the reservoir full, but do not overfill.

RINSE AID DISPENSER

- 1 Lift up the end tab of rinse aid cover to open.

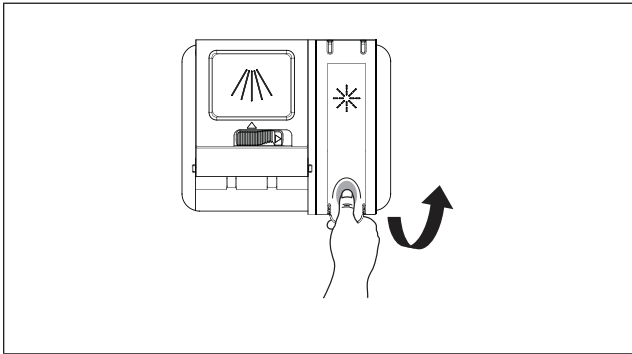

- 2 Fill the rinse aid dispenser with liquid rinse aid until full. Do not overfill.

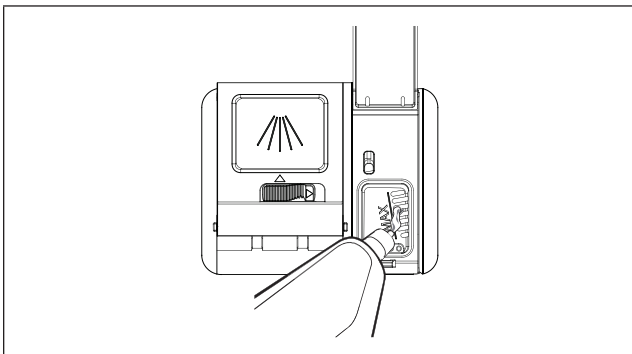

NOTE: Use the viewing port when filling the rinse aid reservoir.

⚠WARNING Do not fill the reservoir above the full level indicator. Excess rinse aid can overflow during the wash cycle.

- 3 Press the rinse aid cover down firmly to close.

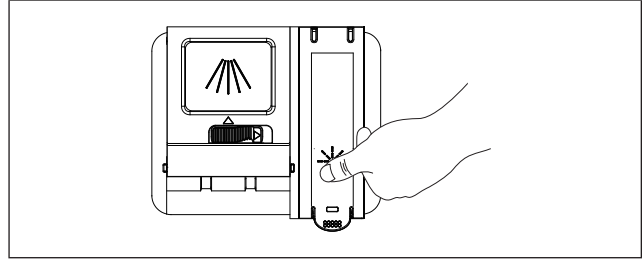

TO ADJUST THE RINSE AID SETTING

You can adjust the amount of the rinse aid released during the rinse aid according to the following steps:

- 4 Close the door and power on the dishwasher.
 - 1 Within 60 seconds after step 1, press the Rinse Only button more than 5 seconds to enter into the setting mode, the rinse aid indicator will blink quickly.
 - 2 Press the Rinse Only button to select the proper setting according to your using habits. The setting will change in the following sequence: d3→d4→d5→d1→d2→d3.
 - 3 Without any operation in 5 seconds or press the Power button to complete the setting and exit the setting mode.

DISHWASHER CYCLE OPTIONS

CYCLE CHART

PROGRAM	DESCRIPTION OF CYCLE	DETERGENT (IN OUNCES)	WATER (IN GALLONS/ LITERS)	CYCLE TIME (IN MINUTES)
HEAVY DUTY	Pre-Wash 1	Pre-Wash 0 oz Main Wash 19.4 oz	7.1 gal/27 l	No Options: 151 min Heated Dry: 180 min Half Load: 160 min Sanitize: 187 min
	Pre-Wash 2			
	Main Wash (140°F)			
	Rinse 1			
	Rinse 2			
	Last Rinse (149°F)			
	Drying			
NORMAL	Pre-Wash 1	ANAM. NSF: Pre-Wash 0 oz Main Wash 19.4 oz CU: Pre-Wash 15 oz Main Wash 15 oz DOE: Pre-Wash 0 oz Main Wash 9.7 oz	3.0-7.0 gal/ 11.5-26.5 l	No Options: 108-146 min Heated Dry: 137-175 min Half Load: 129-155 min Sanitize: 155-185 min
	Pre-Wash 2			
	Main Wash 1 (107.6-140°F)			
	Rinse 1			
	Rinse 2			
	Last Rinse (136.4-149°F)			
	Drying			
DELICATE	Pre-Wash 1	Pre-Wash 0 oz Main Wash 19.4 oz	7.0 gal/26.5 l	No Options: 118 min Heated Dry: 147 min Half Load: 135 min Sanitize: 164 min
	Pre-Wash 2			
	Main Wash (122°F)			
	Rinse 1			
	Rinse 2			
	Last Rinse (136.4°F)			
	Drying			
EXPRESS WASH	Pre-Wash (131°F)	Pre-Wash 0 oz Main Wash 19.4 oz	4.1 gal/15.5 l	No Options: 60 min Heated Dry: 115 min Half Load: N.A. Sanitize: 150 min
	Main Wash (131°F)			
	Rinse (134.6°F)			
	Last Rinse (136.4°F)			
	Drying			
RINSE ONLY	Pre-Wash	0 oz	2.0 gal/7.6 l	No Options: 20 min Heated Dry: N.A. Half Load: N.A. Sanitize: N.A.

DISHWASHER CYCLE OPTIONS

CYCLE TIME WITH OPTIONS

PROGRAM	DESCRIPTION OF CYCLE	NULL	HEATED DRY	HALF LOAD	SANITIZE
HEAVY DUTY	Pre-Wash 1	151	180	160	187
	Pre-Wash 2				
	Main Wash (140°F)				
	Rinse 1				
	Rinse 2				
	Rinse (149°F)				
	Drying				
NORMAL	Pre-Wash 1	108-146	137-175	129-155	155-185
	Pre-Wash 2				
	Main Wash 1 (107.6-140°F)				
	Rinse 1				
	Rinse 2				
	Last Rinse (136.4-149°F)				
	Drying				
DELICATE	Pre-Wash 1	118	147	135	164
	Pre-Wash 2				
	Main Wash (122°F)				
	Rinse 1				
	Rinse 2				
	Last Rinse (136.4°F)				
	Drying				
EXPRESS WASH	Pre-Wash (131°F)	60	115	N.A.	150
	Main Wash (131°F)				
	Rinse (134.6°F)				
	Last Rinse (136.4°F)				
	Drying				
RINSE ONLY	Pre-Wash	20	N.A.	N.A.	N.A.

WASH CYCLE SELECTIONS

Cycle times are approximate and will vary with options selected. Hot water is necessary to activate dishwasher detergent and melt fatty food soils. An automatic sensor will check the incoming water temperature, and, if it is not hot enough, the timer will be delayed for automatic water heating in the main wash of all cycles. This happens even when HI-TEMP WASH is selected as an even higher temperature will be guaranteed to handle heavier soil loads.

NOTE: The energy usage label is based on Normal cycle with Heated Dry option selected and with the upper rack in the raised position.

CARE AND CLEANING

CLEANING THE DISHWASHER

EXTERIOR DOOR AND PANEL

- 1 Regularly clean the stainless steel door and handle with a soft cleaning cloth to remove any debris. Do not use appliance wax, polish, bleach or products containing chlorine to clean the stainless steel door.
- 2 Gently clean the control panel with a lightly dampened cloth.

STAINLESS STEEL INNER DOOR AND TUB

The tub is made of stainless steel; it will not rust or corrode if the dishwasher is scratched or dented. Do not clean the dishwasher interior until it has cooled. Wear rubber gloves. Do not use any type of cleanser other than dishwasher detergent because it may cause forming or create suds.



Clean any spots on the steel inner door and tub with a damp, nonabrasive cloth.

FILTER SYSTEM

The Cylinder Filter is designed to collect some big items such as broken glass, bones and pits. The Cylinder Filter needs to be cleaned to maximize wash performance.

⚠ WARNING

BURN HAZARD

Allow heating element to cool before cleaning the interior. Failure to do so can result in burns.

CLEANING THE FILTERS

Check and clean the filters regularly for best performance.

- 1 Remove the lower dishwasher rack.
- 2 Rotate the Cylinder filter counterclockwise a quarter turn and lift up to remove.

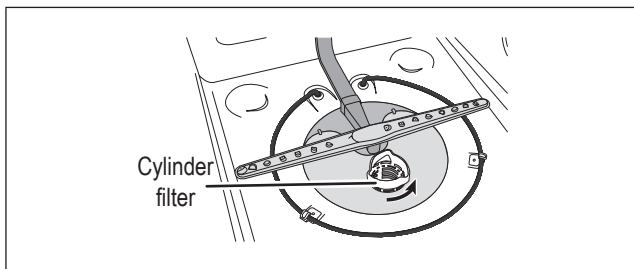

- 3 Empty the Cylinder filter and rinse it under running water.

- 4 Remove the Fine filter.

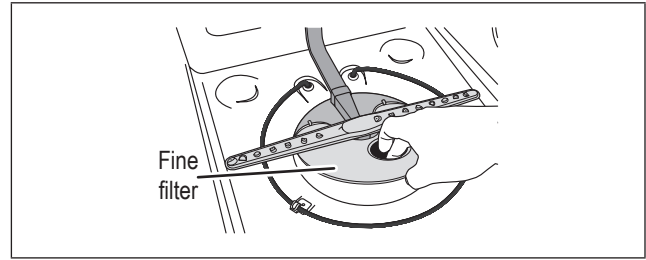

- 5 Remove the Micro filter from the bottom of the tub.

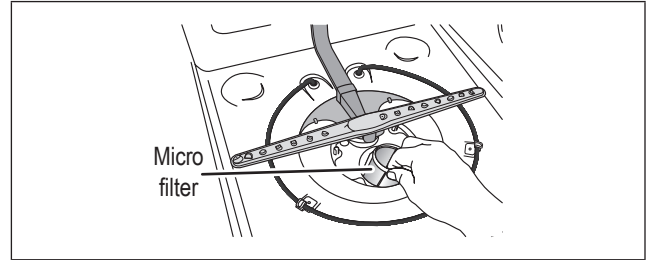

- 6 Inspect both the Fine filter and the Micro filter for debris and then clean them by holding the filters under slow running water.

NOTE: A stiff, plastic bristle brush may be needed to remove some debris.

- 7 Reinstall the filters in reverse order. Ensure the Cylinder filter locks into place.

NOTE: Failure to correctly re-install the filters will result in diminished performance and a potential need for service.

DOOR GASKET

Clean the door gasket with a damp cloth regularly to remove food particles.

AIR GAP

If there is an air gap installed with your dishwasher, make sure it is clean, so the dishwasher will drain properly.

Before cleaning the air gap, first turn off the dishwasher and lift off the cover. Remove the plastic cap and clean with a toothpick.

NOTE: Air gap is an external plumbing device that is not part of your dishwasher. The warranty provided with your dishwasher does not cover service costs directly associated with the cleaning or repair of the air gap.

PROTECT AGAINST FREEZING

Your dishwasher should be properly protected from freezing when left in an unheated place. Have a qualified technician perform the steps listed below in this section.

TO DISCONNECT SERVICE

- 1** Turn off electrical power to the dishwasher at the supply source by moving fuses or tripping the circuit breaker.
- 2** Turn off the water supply.
- 3** Place a pan under the inlet valve. Disconnect water line from inlet valve and drain into pan.
- 4** Disconnect drain line from pump and drain water into pan.

TO RESTORE SERVICE:

- 1** Reconnect the water, drain and electrical power supply.
- 2** Turn on water and electrical power supply.
- 3** Fill both detergent cups and run dishwasher through a heated wash cycle.
- 4** Check connections to make sure they do not leak.

TROUBLESHOOTING

BEFORE CALLING FOR SERVICE

PROBLEM	POSSIBLE CAUSE	SOLUTION
Dishwasher won't start	Door may not be closed properly	Ensure the door is properly closed
	Power supply or power line is not connected	Ensure power supply is correctly connected
	Delay Start option has been selected	Refer to delay start section in this manual to reset
	Child lock activated (selected models)	Refer to child lock section in this manual to deactivate the child lock
Dishwasher beeps at the end of the cycle	Indicates the wash cycle is finished	
Rinse aid light is on	The rinse aid level is low	Add rinse aid
Dishwasher operates too long	The dishwasher is connected to cold water	Make sure the dishwasher is connected to hot water supply
	The cycle time will vary depending on the soil level of the dishes	When heavy soil is detected, the Auto and Normal cycles will automatically increase the cycle time
	The sanitize option is selected	When Sanitize option is selected, the cycle time will be increased to meet the sanitize temperature requirement
Dishes are not clean enough	Water pressure is temporarily low	Use dishwasher when the water pressure is normal
	The inlet water is low	Make sure the dishwasher is connected to the hot water supply Try not to use the dishwasher when hot water is being used elsewhere in the house
	Dishes are loaded too close together	Load the dishes again as the manual indicates
	Improper use of detergent	Using fresh detergent, add the correct amount depending on the water hardness and the selected cycle
	The selected cycle is not suitable for food soil condition	Choose another cycle for longer washing time
	Spray arms are blocked by items	Make sure the spray arm is rotated fully
Dishes are not dry enough	Rinse aid dispenser is empty	Fill rinse aid dispenser or increase the amount of rinse aid
	Improper loading of dishes	Load the dishes again as the manual indicates
	The selected cycle did not include drying	Choose the proper cycle with drying
Spots and filming on dishes	Water hardness is too high	For extremely hard water, install a water softener
	Improper loading of dishes	Load the dishes again as the manual indicates
	Old or damp powder rinse aid is used	Use fresh rinse aid
	Rinse aid dispenser empty	Add rinse aid to the dispenser
	Water temperature is too low	For best results, water should be a minimum 120°F as it enters the dishwasher.
Etching	Use of too much detergent	Use less detergent if you have soft water etching
	The inlet water temperature exceeds 150°F	Lower the inlet water temperature
Detergent left in dispenser cup	Detergent may be too old	Use fresh detergent
	Spray arm is blocked	Load the dishes, making sure the spray arms are not blocked

TROUBLESHOOTING

PROBLEM	POSSIBLE CAUSE	SOLUTION
Detergent dispenser will not close	Improper operation of the detergent cover	Add the detergent and rinse aid as indicated by the manual
Water remains in the dishwasher	Previous cycle has not finished or has been interrupted	Select the proper cycle as indicated by the manual
Dishwasher does not drain properly	Drain is clogged	Check the air gap if it is installed Make sure the disposer is empty if the dishwasher is connected to the disposer
	Drain hose is kinked	Be sure the drain hose is properly connected to the sink
Suds in the tub	Improper detergent is used	Be sure to use only the automatic dishwasher detergent
	Excessive suds caused by using the improper detergent	Make sure to use only the automatic dishwasher detergent
Dishwasher leaks	Dishwasher is not level	Level the dishwasher (see the installation manual)
Black or gray marks on dishes	Aluminum utensils have rubbed against dishes	Choose a higher cycle Make sure the inlet water temperature is no less than 120°F
Stained tub interior	Coffee and tea soil	Use a spot cleaner to remove the soil
	Reddish stain	Some tomato-based foods will cause this. Use of the rinse only cycle right after loading this will decrease the staining
Noise	Detergent cup opening or drain pump sound	This is normal
	A hard object has entered the wash module. When the object is ground up, the sound should stop	If the noise persists after a complete cycle, call for service
Dishwasher won't fill	Water valve is shut off	Make sure water valve is open
	Door latch may not be properly seated	Make sure the door is closed
	Water pressure is too low	Verify a minimum of 20 psi water pressure is maintained during the filling operation.

ERROR CODES

If there is a malfunction the dishwasher will display an error code. The following table shows possible error codes and their causes.

CHECK CODE DISPLAY	POSSIBLE CAUSES
E1	<ul style="list-style-type: none">• The water supply pressure is low.• The water supply valve is closed.• The non-water switch is broken.• The wash pump does not work.• The main PBA has some problems.
E2	<ul style="list-style-type: none">• The high-water float switch is broken.• The water valves always open (it cannot be closed).• The main PBA has some problems.
E3	<ul style="list-style-type: none">• The heater is broken.• The thermistor doesn't work normally.• The main PBA has some problems.
E4	<ul style="list-style-type: none">• The case brake fails to detect the pulse.• The valve water is out of order.• The overflow sensor is broken.• There is a water leakage.
E6	<ul style="list-style-type: none">• The Thermistor is broken.• The main PBA fails to detect the pulse.
E7	<ul style="list-style-type: none">• The Thermistor is broken.• The main PBA fails to detect the pulse.
Ed	<ul style="list-style-type: none">• The main PBA or sub PBA is out of order.• The communications connection for the main PBA or sub PBA is not properly connected.

SHARP®

SHARP ELECTRONICS CORPORATION • 100 Paragon Drive • Montvale, New Jersey 07645 • USA
800-BE-SHARP (800-237-4277)