

SHARP

Be Original.

Electronic Paper Display EP-C131/C251 Installation Guidelines

<Ver. 1.0>

December 2023

Digital Imaging Solutions Unit
SHARP Corporation

Installation Guidelines Contents

Handling this document

This document is to explain how to design and install the monitor for our business partners. Please do not distribute this document or its contents to other companies, or use it in products of other companies. Please note that value and expressions on this document are subject to change without notice.

Table of contents

1. Overall precautions		3. Installation considerations	
1.1. Overall precautions	...4	3.1. How to unpack	...22
2. Design precautions		3.2. Checking for screen abnormalities	...23
2.1. Temperature conditions, The effect of dust and afterimage	...6	3.3. Attachment precautions	...24
2.2. Precautions for direct sunlight	...7	3.4. Precautions when hanging installation	...25
2.3. Precautions for installation location, dew condensation, water drops and salt damage, etc.	...8		
2.4. Maintenance & Checking Items	...9		
2.5. Notes on rewriting temperature range	...10		
2.6. Connection terminals/button/indicator	...11		
2.7. About power supply and the mobile battery	...12		
2.8. About evaluated mobile batteries	...13		
2.9. About fixing the mobile battery	...14		
2.10. Precautions for orientation	...15		
2.11. About portrait installation	...16		
2.12. About how to rewrite the display	...17		
2.13. About setting up this monitor	...18		
2.14. Dimensional requirements for USB flash device	...19		
2.15. About the security features of this monitor	...20		

1.Overall precautions

1.1. Overall precautions

Precautions for Usage, Installation

- Do not use the Electronic Paper Display under following conditions ;
 - 1) Usage beyond its capability, feature/function, accuracy/precision
 - 2) Usage that could develop into injury or life-threatening situation under product breakdown
 - 3) Usage that could lead to major financial damage

We will not take any responsibility if the product was used under the above conditions.

<Example>

Control of all types of safety-related usage of transportation equipment (airplane, train, car, etc.), aerospace equipment, communication equipment, nuclear control equipment, medical equipment, disaster-prevention/security equipment, all types of safety equipment, etc.

- We will not take any responsibility for any failure, damage, loss, etc. which caused by particular installation (high-ceiling mounting etc.) and/or installation by non-Sharp related parties. Prior to the installation, please examine the potential problems by the installation location and installation method, and only operate in the appropriate environment.

In case of product failure, removal and installation expenses incurred will be the customer's responsibility. Repairing may take a certain times period. For that reason, arranging of a back-up is recommended.

- Installation environment of the Electronic Paper Display differs by individual cases. Please make appropriate installation by referring to this material. If you have any difficulty in making judgment about installation or have any comments/questions about the contents of this material, please contact SHARP sales subsidiaries.

2. Design precautions

2.1. Temperature conditions, The effect of dust and afterimage

Temperature conditions

- Operating temperature conditions
 - Operating temperature range :
body:0 °C(32°F) ~50°C(122°F), AC adaptor:0 °C(32°F) ~35°C (95°F)
 - Rewriting temperature range : 15 °C(59°F)~35°C(95°F)
 - Operating Humidity range : 20%~80%RH (No condensation)
- Install this monitor in an environment that meets these conditions.
- This monitor has a built-in temperature sensor. **Please note that the display screen cannot be rewritten if the temperature is outside the rewriting temperature range.**
 - Please limit the installation and operation to meet the rewriting temperature range conditions.
For example, it is not suitable for rewriting when the air conditioning is stopped late at night in winter.

The thermal influence

- If the temperature is too high → Electronic component's lifetimes will be shortened or broken.
- If the temperature on LCD surface is too high → Monitors will break down or uniformity issue will occur
- If the temperature is too low → Monitors will break down, will not start up or monitor issue will occur.

The effect of dust

- This monitor is for indoor use only.
- Compared to general LCD displays, this monitor consumes less power and is sealed without heat radiation holes, so it is designed to prevent dust from entering the screen.
- However, it is not suitable for locations with more dust than expected, such as outdoors, areas with heavy traffic, and areas near roads.
- If there is a possibility of such installation, please be sure to consult with our sales representative.

The effect of afterimage

- If the following phenomenon occurs when displaying the same image for a long times:
- This phenomenon can be improved by changing the display image.
- We recommend that you change the displayed image regularly (once every 3 days as a guide).
 - ◇Symptoms like afterimages
 - ◇White colors are displayed as light gray, and black colors are displayed as dark gray.

2.2. Precautions for direct sunlight

This product is for indoor use. Please set this monitor in a place away from to the direct sunlight, wind or rain.

These conditions may cause failure and/or deterioration.

Effects of direct sunlight and heat

Do not use in places exposed to direct sunlight.
Avoid heat.

- Exposure to direct sunlight may cause the cabinet to deform or malfunction.
- If installed in a place where the temperature is high, the cabinet may become deformed or malfunction.
- Please note that the effects of ultraviolet rays and infrared rays may cause problems such as panel damage or discoloration, which may not recover even if the temperature returns to normal.

Measures against sunlight

Please take measures against ultraviolet rays ,infrared rays and temperature.

- Set a sun-shade above the monitor
- Utilize the shade of the building
- Place the monitor where there is no direct sunlight
- Change the direction of the monitor to avoid sunlight
- Using some object which can block out the direct sunlight (You should pay attention to strong winds like hurricanes.)

2.3. Precautions for installation location, dew condensation, water drops and salt damage, etc.

About installation location, dew condensation, water drops and salt damage

- This product is for indoor use. Please do not expose to weather and direct sunlight when installing. They cause breakdown and degradation.
- Humidity condition for IDP
- Dew condensation and/or liquid drops will cause the breakdown of the circuit and/or LCD panel. Please install LCD away from condensation and liquid drops.
- The environment which has high possibility of condensation
 - Place where temperature is generally low but has frequent warm air flow.
(For example : the place in front of the vents of radiators. When the radiator is turn on in a cold winter morning, condensation occurs.)
 - Near the sea, lake, mountain and so on where humidity is high
- The environment which has high possibility of water drops
 - “Semi-outdoor” place where strong winded-rain(typhoon) could potentially reach the monitor.
 - The place which is below the pipes inside the ceiling. (When installing in these places, countermeasures should be taken to avoid water drops to reach the monitors.
For example, covering the LCD monitor with box. In such a case, do not install in a place where the wind is blowing.)
- Caution for the wind of the typhoon
 - Please install so that you can remove the influence from the wind.
- Caution for salt damage
 - Please consult with an authorized SHARP servicing dealer with us in advance when installing near the sea where salt damage may occur.
- Caution for sulfide
 - Please don't install near the hot spring and volcano where there may occur the influence from sulfide.
- Caution for organic gas and flammable gas
 - Please don't install the place where there may be organic gas and flammable gas.
- Caution for oil smoke
 - Please don't install in a place with a lot of oily smoke such as the kitchen or its vicinity.
- Caution for iron powder
 - Please don't install in places where iron powder dances, such as in factories.

Cleaning of monitor surface

Please inform the actual users of the following points.

- Wipe the monitor surface gently with a soft cloth (lens cleaner or gauze, etc). Do not rub strongly.
The monitor surface may be damaged with a hard cloth.
- Use a commercially available static electricity removal brush (dustproof brush) when dust attaches to the monitor surface.
- Do not wipe with a damp cloth, dusty cloth, and chemical wiping cloth.

2.5. Notes on rewriting temperature range

- The operating temperature range of this device is 0 to 50°C (AC adapter: 0 to 35°C), but **the rewriting temperature range is 15°C to 35°C**.
- Please note that this device has a built-in temperature sensor, and **the display screen cannot be rewritten if the temperature is outside the rewriting temperature range**.
- Since the device operates based on the temperature detected by the temperature sensor built into the device, rewriting may not be possible even if the outside temperature is within the rewriting range.
- Please limit the installation and operation to meet the rewriting temperature range conditions.
For example, it is not suitable for rewriting when the air conditioning is stopped late at night during winter.

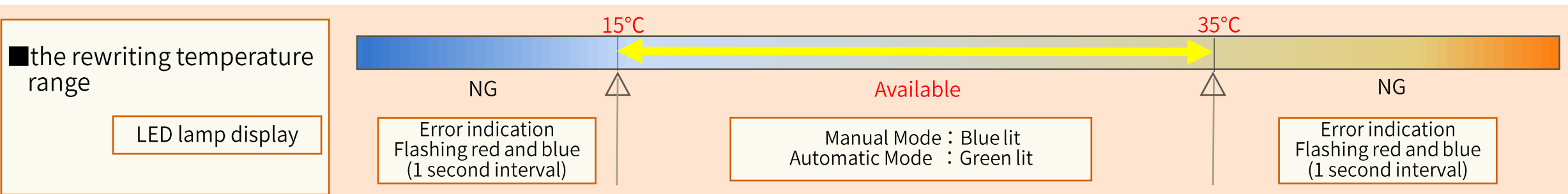
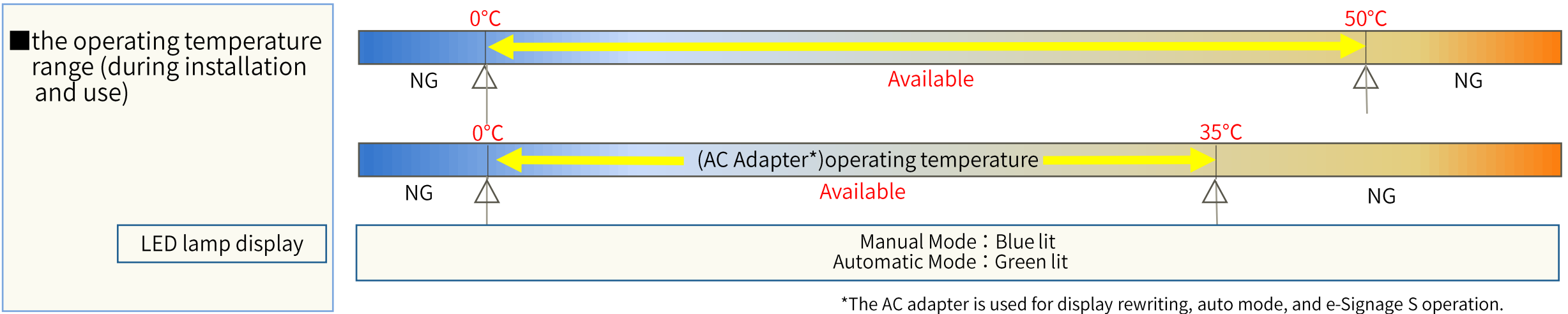

2.6. Connection terminals/button/indicator

[EP-C251]

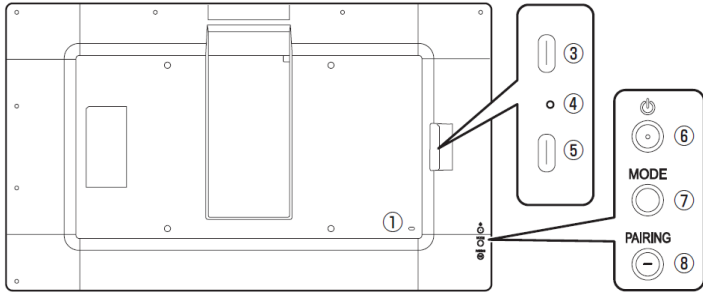

[EP-C131]

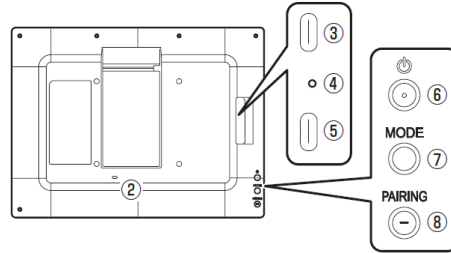

■ Button/connection terminals

- ①② Anti-theft hole
- ③ Power input terminal (USB Type-C)
- ④ Indicator
- ⑤ Computer/USB flash drive connection terminal (USB Type-C)
- ⑥ Power button
- ⑦ MODE button
- ⑧ PAIRING button

■ Button

POWER		
When power is off	Press and hold for approx. 3 seconds.	Turn power ON
When power is on	Press and hold for approx. 3 seconds.	Turn power OFF
When power save mode is ON	Press for approx. 1 second.	Return from power saving state
MODE		
Switching slide mode	Press and hold for approx. 3 seconds.	Switching between [Auto mode] and [Manual mode]
When automatic mode	Press for approx. 1 second.	Pause/resume playback
When manual mode	Press for approx. 1 second.	Save next image
When power is on	Press and hold for approx. 30 seconds.	All reset
PAIRING		
When Bluetooth is off	Press for approx. 1 second.	Bluetooth ON
When Bluetooth is on	Press and hold for approx. 5 seconds.	Bluetooth OFF

■ Indicator pattern

Status	Status of this monitor
Power OFF	Off
During startup	Green flashing
Automatic mode in operation	Green lit
Manual mode in operation	Blue lit
Pause (Automatic mode in operation)	Green and Blue lit alternately
Bluetooth pairing underway	Blue flashing (at approx. 0.25 seconds interval)
Kye lock in operation (Automatic mode)	Green flashing (Green 2 seconds ON and 1 second OFF cycle)
Kye lock in operation (Manual mode)	Blue flashing (Blue 2 seconds ON and 1 second OFF cycle)
When temperature is abnormal	Red and Blue flashing
When accessing USB flash device	Red flashing(0.25 seconds interval)
Factory reset in operation	Red flashing(0.5 seconds interval)
When updating firmware	Red flashing(0.5 seconds interval)

2.7. About power supply and the mobile battery

About power supply

- Use only the power cord and AC adapter supplied with the monitor.
- This monitor can use a mobile battery for smartphones, etc. The mobile battery that can be used is subject to the following specifications.
- When not using the mobile battery, disconnect the cable from the terminal of the monitor.

Mobile battery specification conditions

	EP-C131	EP-C251
Rating (PD specifications)	20W or more but less than 120W	45W or more but less than 120W
Rated voltage	15V	20V
Battery capacity	2,000mAh or more recommended	

Please follow the usage conditions (ambient temperature, etc.) and precautions and instructions listed in the instruction manual of the mobile battery you are using.

Storage space

The mobile battery can be stored on the back of the main unit. Please refer to the diagram below for installation and storage space.

<EP-C131>

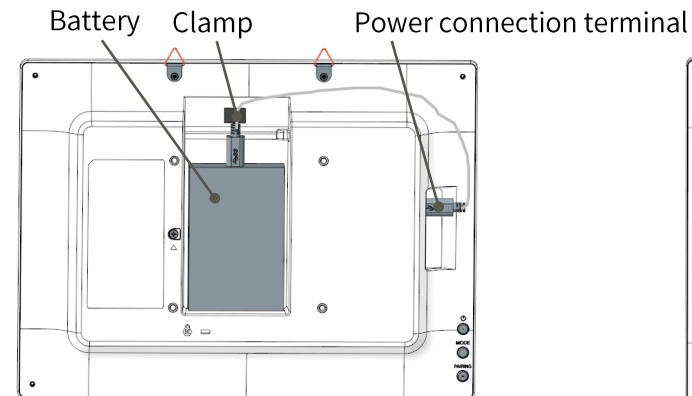

storage space :
Height 115.1 x Width 69 x Thickness 14.9mm

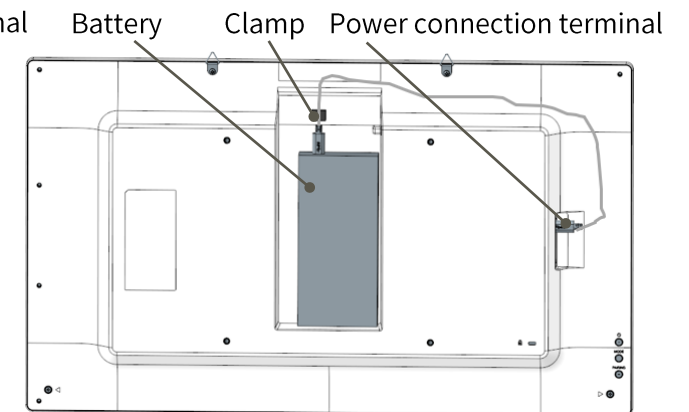

<EP-C251>



storage space :
Height 190 x Width 100 x Thickness 23.2mm

2.8. About evaluated mobile batteries

■ mobile batteries
life / number of rewrites
possible

		For EP-C131			For EP-C251	
		Baseus PPCXM06			ANKER 537	
						
How to handle batteries	Power save mode*2	Rewriting timing	Battery life	Number of rewrites possible	Battery life	Number of rewrites possible
Handling 1	OFF	Once a day	17 hours	1 time	42 hours(1 day)	1 time
		Once per hour	16 hours	16 times	39 hours(1 day)	39 times
		Once per minute	12 hours	72 times	27 hours(1 day)	162 times
	ON	Once a day	94 hours(3days)	3 times	106 hours(4 days)	4 times
		Once per hour	66 hours(2days)	66 times	86 hours(3 days)	86 times
		Once per minute	26 hours(1day)	156 times	43 hours (1day)	258 times
Handling 2	-	Once a day	4,113 hours (171 days)*3	171 times	6,470 hours (269 days)*3	269 times
		Once per hour	205 hours(8 days)	205 times	363 hours(15 days)	363 times
		Once per minute	34 hours(1day)	204 times	61 hours(2 days)	366 times

Handling 1 Leave the connection cable between the monitor and battery attached.



Turn on the power of the main unit and battery

Handling 2 Unplug the cable every times you rewrite.

When rewriting



After rewriting, disconnect the cable



If the monitor and battery are left connected, power will be consumed due to self-consumption of the battery, so disconnecting the cable after rewriting will reduce self-consumption.

*1) Battery life when Automatic mode (slide setting) is activated. Battery life is the operating times from full charge to 0W.

*2) Set by turning on "Slide Settings" - "Power Saving Mode" by the EPD Settings Tool.

*3) Battery manufacturers recommend charging at least once every three months. (ANKER example)

Usable times is a reference value and is not a guaranteed value. It also varies depending on product-specific variations and usage environment.

2.9. About fixing the mobile battery

- When attaching and fixing the mobile battery to the monitor, please attach a commercially available tape-type hook and loop fastener (velcro) to fix it.
- Please make sure that the hook-and-loop fastener you use has the adhesive strength to hold the mobile battery to prevent the battery from falling off.

Attach the hook-and-loop fasteners to the monitor and battery.



dent on the back of the monitor



The mobile battery



Attach the mobile battery to monitor



2.10. Precautions for orientation

Please use it perpendicular to a horizontal surface. If tilting, please tilt it at a maximum of 20° downward and 90° upward.

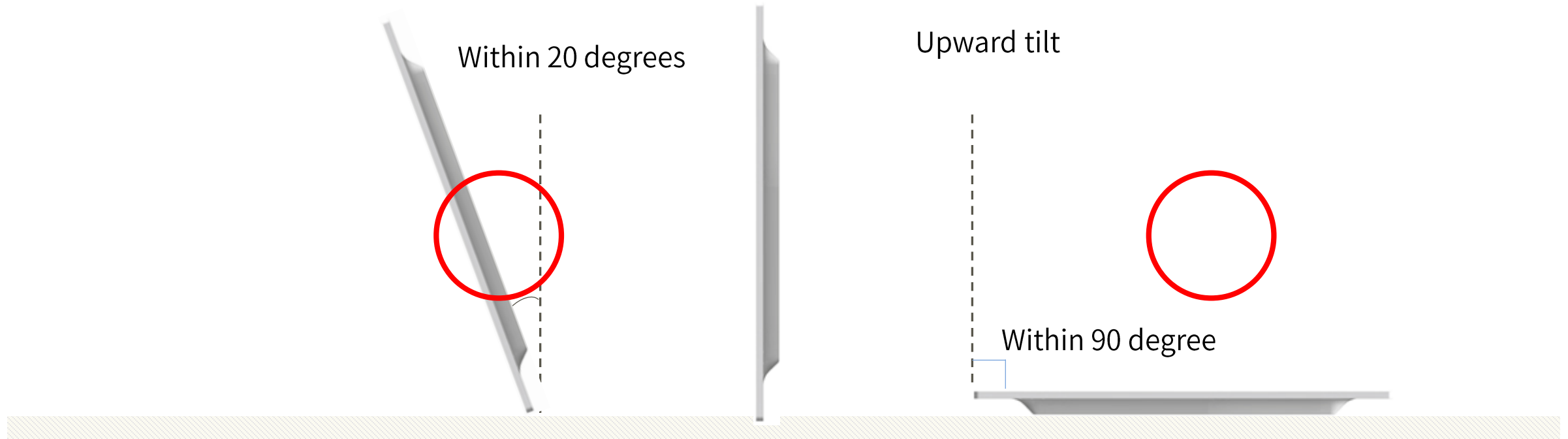

Caution

-In case of portrait installation, please rotate the products counterclockwise 90 degrees when viewed from the front.

-When attaching the mounting plate in portrait orientation, make sure the up-side by the label indicates the upside to display properly.

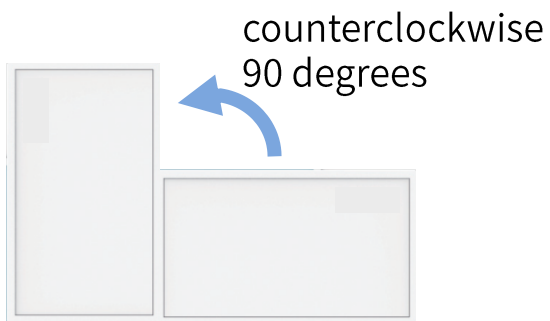

When placed vertically, the connection terminals are facing downwards.



Rating plate

Precautions when installing vertically

Please note that if the monitor is installed vertically and the displayed image data is in vertical format, the displayed image data must be rotated 90 degrees.

How to use EPD Settings Tool

- 1) Select the models name of this machine and [Portrait] in the [Slideshow settings]-[Preview] .
- 2) Select a portrait format image to display from [Image list]
- 3) Select [Image Rotation]-[Rotate Right 90]

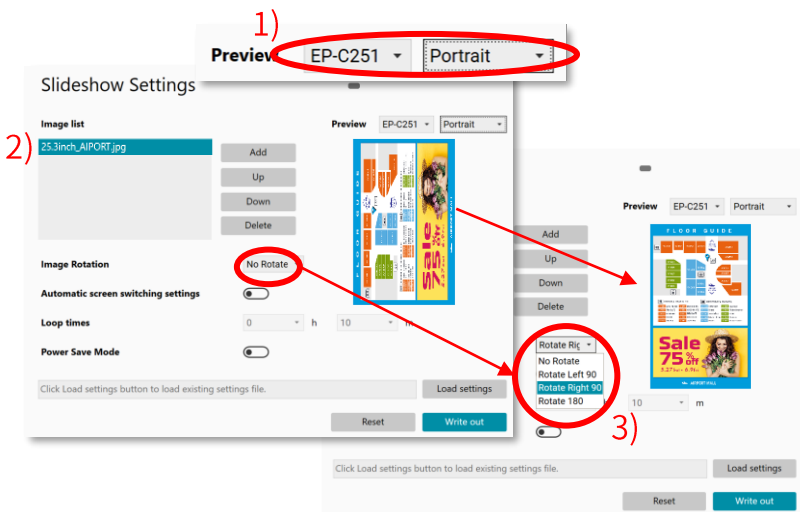

How to rotate the original image

(For the Windows application "Paint")

- 1) Right-click on the image file → [Open from program] → [Paint]
- 2) [Home] → [Image] → [Rotate 90 degrees to the right] and save with any file name.

original image



Rotate 90 degrees
clockwise



2.12. About how to rewrite the display

- The monitor can be rewritten using the USB flash device and PC, Smartphone.
- With e-Signage S (sold separately), it is possible to rewrite and manage the display of multiple monitors via wireless LAN connection.
- For details, please check the operation manual and EPD settings tool operation manual.

1:1 rewrite

Rewrite image by the USB flash device where the image is saved



Type-C USB flash device is required.

Rewrite image by connecting to PC using USB cable



EPD settings tool is required.

Rewrite image from the smartphone via Bluetooth connection



The dedicated app for Android OS smartphones is required.

Automatically rewrite multiple devices

Rewrite image on multiple monitor via wireless LAN connection



e-Signage S is sold separately. Please contact our sales representative for details.

2.13. About setting up this monitor

-This monitor can be set up using EPD settings tool for Windows OS.

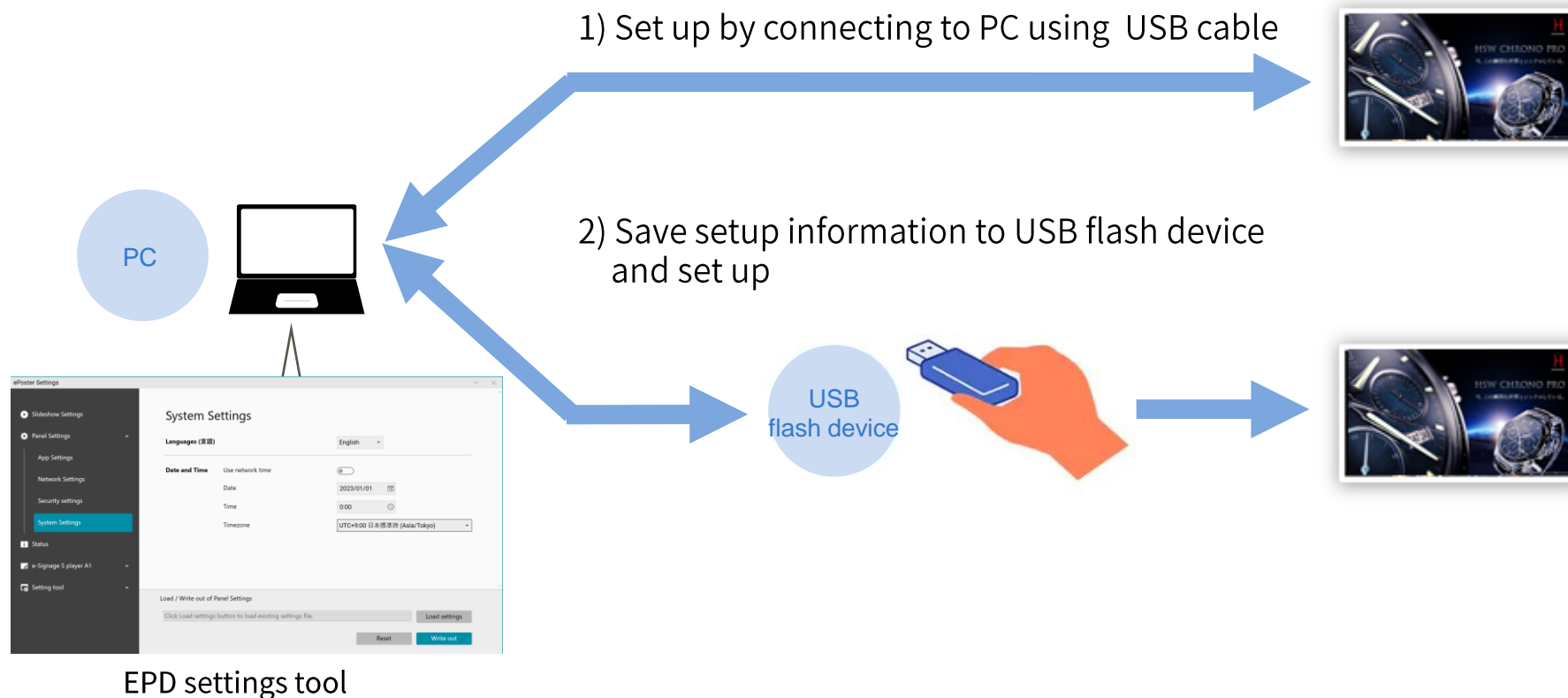

2.14. Dimensional requirements for USB flash device

Type-C USB flash device is required. When using a Type-A USB flash device, please connect a third-party TypeC to TypeA conversion adapter, etc.

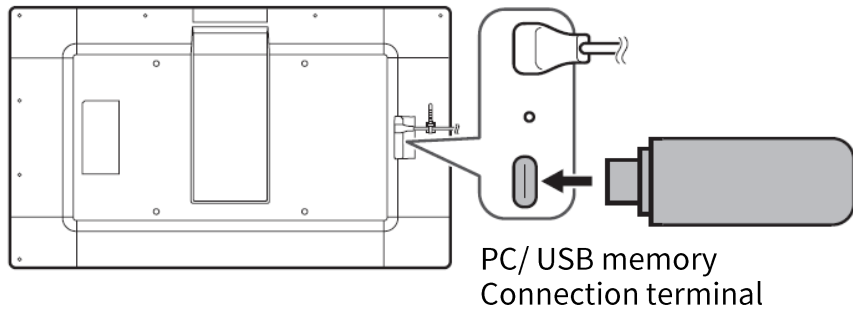

【Recommended size of USB flash device】

Model	Recommended size (mm)
EP-C131	W21 x T6.6 x L35.4 less than
EP-C251	W15 x T10 x L77.4 less than

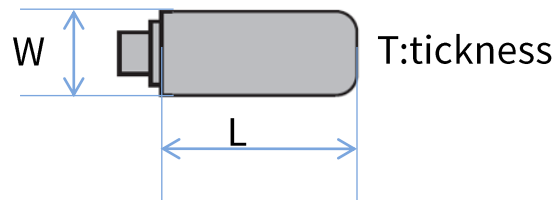

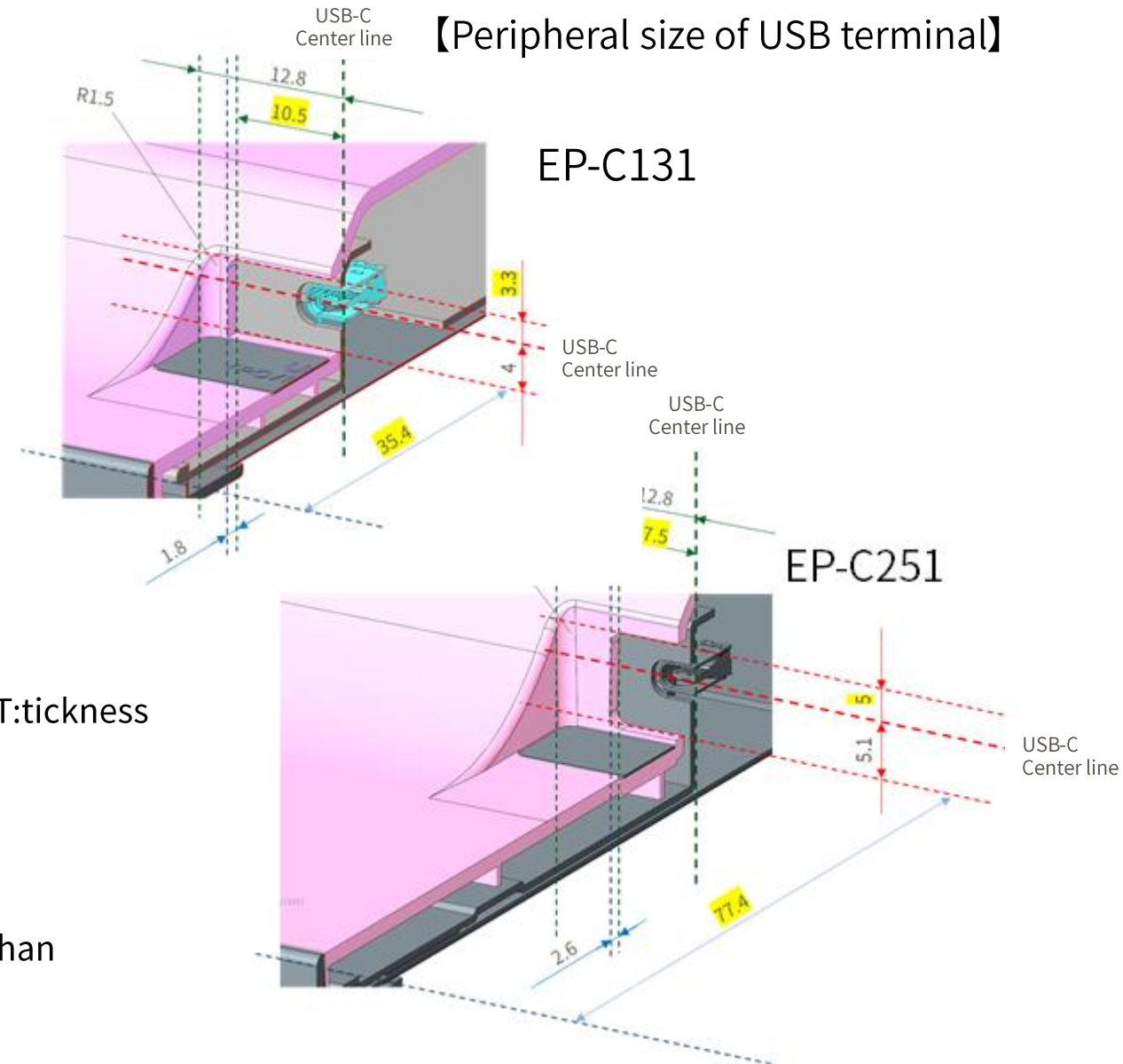

【Peripheral size of USB terminal】



Please note that if you use a USB flash device that is a different size than the recommended size, the USB terminal may be damaged.

2.15. About the security features of this monitor

This monitor is equipped with various security functions to prevent image rewriting and information leakage over the network.

Threat	Security measures	Setting method using EPD settings tool
Maliciously rewriting by USB flash device 	Prohibit access to USB flash device	[Panel Settings]-[Security settings]-[Prohibit importing from USB flash device]-ON
Maliciously rewriting by Smart phone 	Key lock disables pairing button	[Panel Settings]-[Security settings]-[Key Lock]-ON
Information leakage of images and settings (network information, etc.) saved on USB flash device 	By setting the encryption key, the information saved on the USB flash device cannot be checked.	[Setting tool]-[Application Settings]-[Use encryption key]-ON

3. Installation considerations

3.1. How to unpack



1) Cut the tape on the top box of the main unit.



2) Place the monitor with the front facing down. Please check the printing on the packaging box for direction. (the below described)



3) Pull out all contents and remove accessories.



4) Remove the upper packaging material and take out the monitor.

<Printed content on the top of the packaging box>

SHARP
EP-C131

Be sure to turn this side down when unpacking
Assurez-vous de retourner ce côté lors du déballage
Asegúrese de girar este lado hacia abajo al desembalar



<EP-C131>



Other accessories

Paper stand

<EP-C251>



AC adapter,
Metal fittings

AC code

3.2. Checking for screen abnormalities

Check for screen abnormalities when unpacking

When unpacking the product, be sure to check for any screen abnormalities due to initial defects or defects during storage or transportation.

- 1) Connect the AC adapter to the power connection terminal (USB Type-C) of the monitor and turn on the power.
- 2) Check for green flashing. → Check that the blue light is lit. → Screen rewriting begins. → Rewriting completed.

【Rewriting completed
(normal)】

A white screen appears

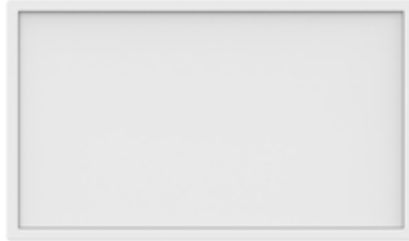

【Rewriting completed
(abnormal)】

Colors other than white
screen are displayed



<Reference>

Even if there is damage to the inside of the screen due to an impact to the screen, the problem will not be confirmed until the screen is rewritten. Screen abnormalities can be confirmed by rewriting the screen.

【Before screen rewriting】

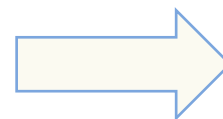

screen rewriting

【After screen rewriting】

Screen abnormalities
can be confirmed



3.3. Attachment precautions

- A mounting bracket compliant with VESA specifications can be used.
- Our company is not responsible for accidents or injuries caused by improper installation or mishandling.
- This monitor and bracket must be installed on a wall which can endure at least 4 times or more the weight of the monitor.
Install by the most suitable method for the material and the structure.
- Do not use an impact driver.
- To attach a VESA-compliant mounting bracket, use M4 screws that are 5/16 inch (8 mm) to 3/8 inch (10 mm) longer than the thickness of the mounting bracket.

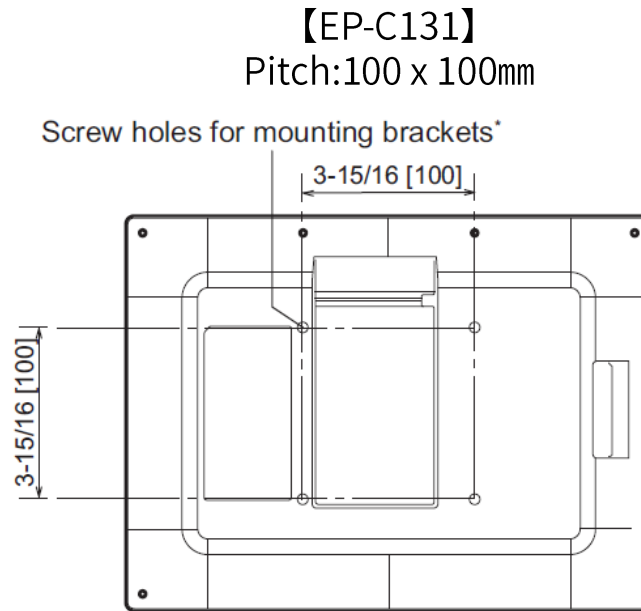
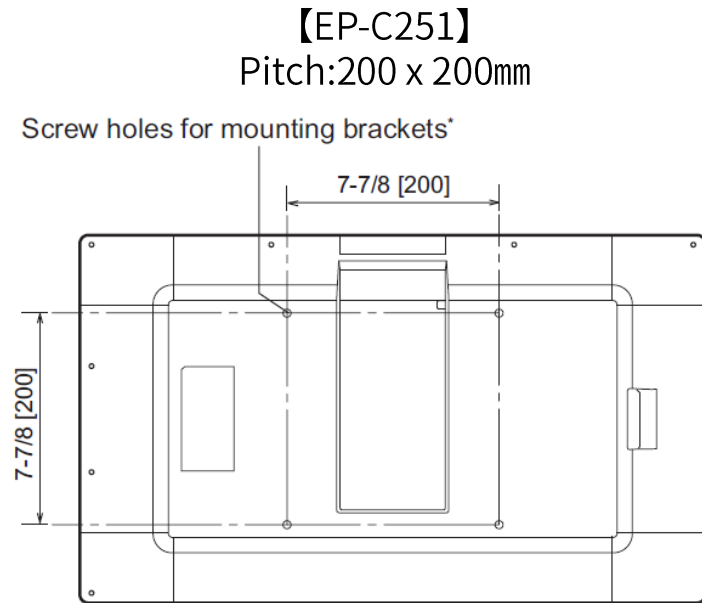

Unit: inch [mm]

5/16 - 3/8 inch (8-10 mm)

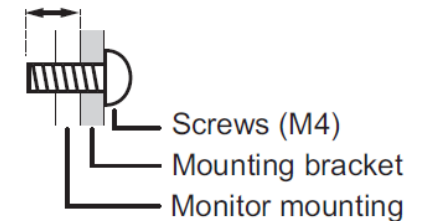

3.4. Precautions when hanging installation

- Hanging brackets (supplied) can be attached in the following positions. Secure the hanging bracket screws (supplied) properly.
- Make sure to hang it using both hanging brackets.
- Ensure that the total hanging weight does not exceed the right. EP-C251: 6.6 lbs. (3.0 kg), EP-C131: 2.2 lbs. (1.0 kg)
- Hang on a wall that is sufficiently strong.
- Please prepare hooks for attaching to the wall, wire for hanging, etc. separately.
- Regarding the hooks that are attached to the wall, if you hang only one hook, the weight of the monitor will be concentrated on one point, so please be careful to ensure that it is not tilted.
- Make sure to use a wire (commercially available) that is sufficiently strong.
- The hanging brackets and hanging bracket screws (supplied) are exclusively for use with this monitor. Do not use them for other devices.
- Our company is not responsible for accidents or injuries caused by improper installation or mishandling.

Hanging image



It is only possible to use the combinations shown below.

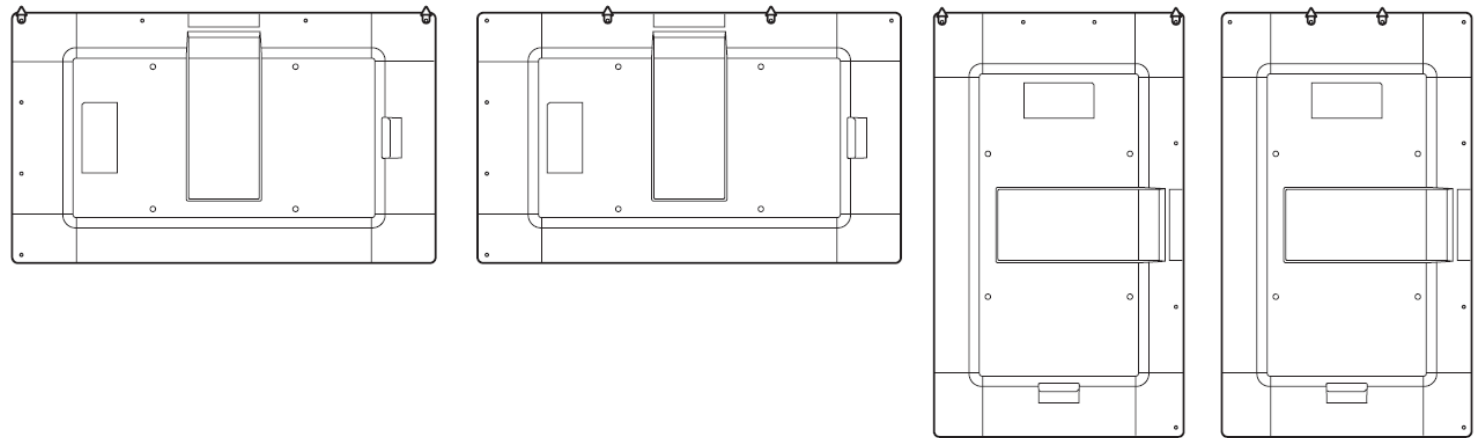

EP-C251 only

SHARP

Be Original.