

SHARP

Be Original.

8M-B120C

120" Class (120" diagonal)
8K Ultra-HD Professional LCD Monitor

All-Enveloping Realism
8K Ultra-HD Quality Takes you to Another World



8K

7680 × 4320 Pixels

Lifelike 8K for Brighter, Livelier Big-Screen Images



120-inch 8K LCD—One of The World's Largest*

To deliver unparalleled detail, 8K packs in 33 million pixels—four times what you get on a 4K panel. The combination of 8K ultra-high resolution and a mammoth 120-inch (120" diagonal) panel creates an incredibly immersive effect—putting you right inside the scene.

*For an 8K LCD monitor, as of July 29, 2020; based on Sharp research.

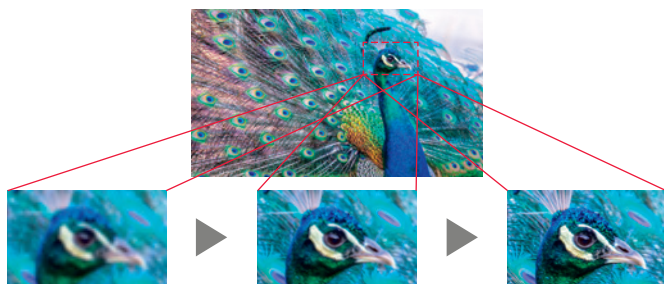
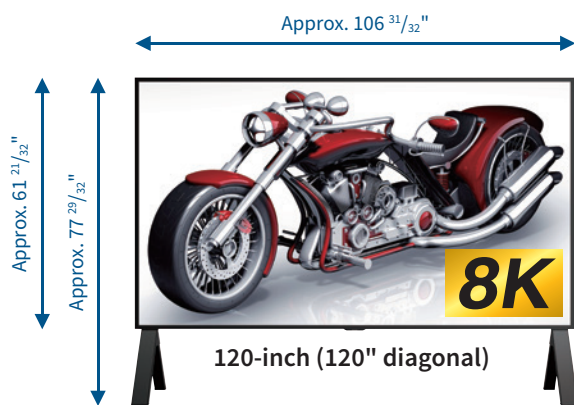

Full-HD panel
1,920 × 1,080 pixels

4K panel
3,840 × 2,160 pixels

8K panel
7,680 × 4,320 pixels

Note: Photos pictorially illustrate differences in resolution.

4K and Full-HD Upscaled to 8K

Sharp's super-resolution technology analyzes video signals to work out the details that are inherent in the original subject and reconstructs minute details. This enables 4K and full-HD content to be upscaled to look like 8K. You get clear, ultra-high-resolution images.

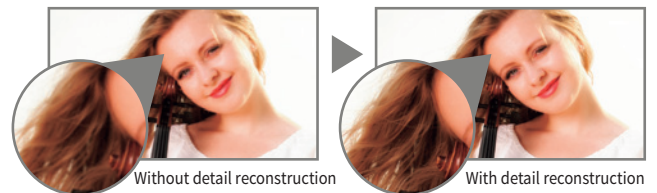

One Billion Colors for Exceptional Vividness

The 8K display employs a wide-color-gamut color filter and optimized LED backlight phosphors. This allows the display to reproduce a rich color gamut (ITU-R BT.2020). You'll see improved reproduction of reds—a tell-tale measure of vividness—and improved gradations of red, blue and green in the pixels. The rich color palette of an 8K monitor adds depth to content and brings the entire screen to life.

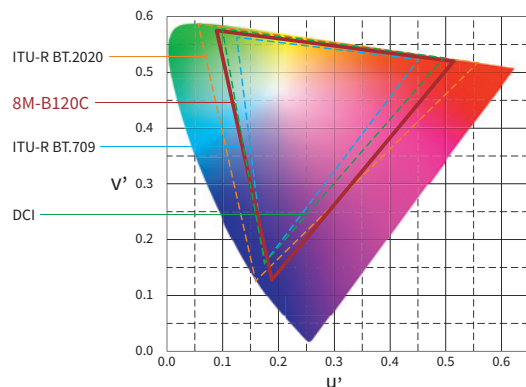



Note: 16-hour continuous operation

Area-Divided Full-Array LED Backlight

The backlight's LEDs sit behind the LCD panel in 2,048 uniform areas. The brightness of the LEDs is controlled independently for each of these areas. Light and dark areas are more distinct and contrast is improved to deliver lifelike images.

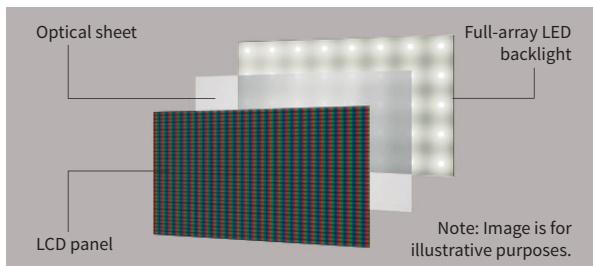

Multi-Screen and Other Display Modes

Content in resolutions up to 4K can be enlarged and upscaled to 8K by the LCD monitor. It can also connect to four PCs via video cables to show content from the PCs on one large screen (a 2 × 2 split screen). You can also choose where to show each image on the screen or display them in a size of your choice.



Mode 1 displays enlarged content in up to 4K resolution (upscaled to 8K)



Mode 2 shows four 4K images to display in 8K resolution

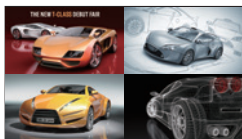

Mode 3 displays four different images (multi-screen)

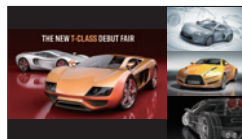

Mode 4 displays four different images in varying sizes (flexible multi-screen)

HDR* For Truly Realistic Depth and Texture

The LCD monitor's image-processing engine restores the wide luminance data recorded in the HDR (High Dynamic Range) standard. Images are then optimally displayed on the high-contrast, low-reflection LCD panel, reproduced with a realistic sense of depth and texture.

*A technology to expand the luminance data contained in the image to make it even more realistic.

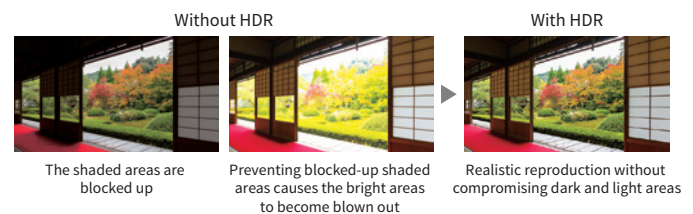

Easy Connection via a Single HDMI™ Cable*

The LCD monitor supports 8K60p/4K120p input via a single HDMI cable.

*Supports 7,680 × 4,320p 60 Hz and 3,840 × 2,160p 120 Hz, as per the HDMI 2.1 specifications.

Command Control via PC

The LCD monitor has a LAN port that lets you control the monitor from a remote PC. You can turn the power on and off, change inputs and more.

Flexible Installation

The LCD monitor comes bundled with a floor stand and wall-mounting brackets—no need for extra hardware*. Eyebolts are provided on the LCD monitor, so you can move the monitor using a crane or other lifting device.

*Certain installation locations may require additional hardware. Installation costs are not included in the product price. For conditions applying to installation, please consult with your local authorized Sharp dealer or representative before purchase. Also be sure to check for safety (such as wall strength) before installing.

Specifications

Model Name		8M-B120C
Installation		Landscape
LCD Panel	120-inch class (120-inch diagonal) UV ¹ A ¹ LCD	
	Backlight	Full-array LED
	Max. Resolution	7,680 × 4,320 pixels
	Max. Display Colors (approx.)	1.07 billion colors
	Pixel Pitch (H × V)	0.346 × 0.346 mm
	Brightness ^{*2}	Up to 600 cd/m ² (HDR: peak 1,500 cd/m ²) when connected to a 200-240VAC power source Up to 300cd/m ² when connected to a 100-120VAC power source
	Contrast Ratio	3,500:1
	Viewing Angle (H/V)	176°/176° (CR ≥10)
	Active Screen Area (W × H)	104 5/8" × 58 27/32"
	Response Time	6 ms (grey to grey, avg.)
Computer Input	Video	Analog RGB (0.7 Vp-p) [75Ω], HDMI compliant
	Synchronisation	Horizontal/vertical separation (TTL: positive/negative)
	Plug & Play	VESA DDC2B
Input Terminals ^{*3}	HDMI: (INPUT 1: HDR [PQ/HLG] compatible, INPUT 2: ARC compatible) × 4 HDMI (for 8K): (INPUT 7: HDR [PQ/HLG] compatible, HDMI × 4) × 1 HDMI (for 8K): (INPUT 8: HDR [PQ/HLG] compatible, HDMI × 1) × 1 ^{*4} PC analog: Mini D-sub 15-pin × 1; USB (photos, video, music) × 2; 3.5 mm-diameter mini stereo jack (video/analog audio) × 1 ^{*5}	
Output Terminals ^{*3}	Digital audio (optical) × 1; 3.5 mm-diameter mini stereo jack (analog audio) × 1; headphones × 1	
Input/Output Terminals ^{*3}	LAN port (10Base-T/100Base-TX) × 1	
Speaker Output	70 W (10 W + 10 W + 10 W + 10 W + 15 W + 15 W)	
Mounting	8 points; pitch: 800 × 800 mm, 800 × 400 mm; M8 screw	
Power Supply	100-120VAC 50/60Hz or 200-240VAC 50/60Hz depending upon line voltage and power cord being used	
Continuous Operation	16 hours	
Power Consumption	1,000W (standby 0.5W) for 100-120VAC or 1520W (standby 0.5W) for 200-240VAC	
Environmental Conditions	Operating Temperature ^{*6}	32°F to 104°F
	Operating Humidity	20% to 80% RH (no condensation)
Dimensions (W × D × H (approx.) (not including protrusions))	Display Only	106 31/32" × 6 13/16" × 61 21/32"
	With Floor Stand	106 31/32" × 31 11/16" × 77 29/32"
Weight (approx.) (not including protrusions)	Display Only	412.3 lbs
	With Floor Stand	454.2 lbs
Main Accessories	200 V AC power cord (3 meters, 3-pin ^{*7}), 100 V AC power cord (3 meters, 3-pin ^{*7}), AV connector conversion cable, remote control unit, battery (AAA size) × 2, set-up manual, cable clamp × 5, floor stand, wall-mounting brackets, eyebolt cover and screws for eyebolt cover (2 sets)	

^{*1}: UV¹A stands for Ultraviolet-induced Multi-domain Vertical Alignment, a photo-alignment technology that ensures uniform alignment of liquid crystal molecules. ^{*2}: Brightness level will decrease slightly over the lifetime of the product. Due to the physical limitations of the equipment, it is not possible to maintain a precisely constant level of brightness. ^{*3}: Use a commercially available connection cable for PC and other video connections. ^{*4}: Supports input via one HDMI cable (7,680 × 4,320p 60 Hz and 3,840 × 2,160p 120 Hz, as per the HDMI 2.1 specifications.) ^{*5}: The terminal is shared with both video and analog audio. For video input, used the bundled conversion cable. ^{*6}: Temperature conditions may change when using the monitor together with optional equipment. In such cases, check the temperature conditions specified by the optional equipment. Also, the operating temperature range may change depending on installation conditions. ^{*7}: Use a 3-pin compatible power outlet.

Compatible Signal Timing (PC)

Screen Resolution	Horizontal Frequency	Vertical Frequency	HDMI			
			INPUT 1	INPUT 2/3/4	INPUT 7	INPUT 8
4K	3,840 × 2,160	54.0 kHz	●	●	●	●
		56.3 kHz	●	●	●	●
		67.5 kHz	●	●	●	●
		112.5 kHz	●	●	●	●
		135.0 kHz	●	●	●	●
8K	7,680 × 4,320	108.0 kHz	—	—	● ^{*1*}	●
		110.0 kHz	—	—	● ^{*1*}	●
		132.0 kHz	—	—	● ^{*1*}	●
		220.0 kHz	—	—	● ^{*1*}	●
		264.0 kHz	—	—	● ^{*1*}	●

Compatible Signal Timing (AV)

Screen Resolution	Frequency	HDMI				
		INPUT 1	INPUT 2/3/4	INPUT 7	INPUT 8	
4K	3,840 × 2,160	24 Hz	●	●	●	●
		25 Hz	●	●	●	●
		29.97 Hz	●	●	●	●
		30 Hz	●	●	●	●
		50 Hz	●	●	●	●
		59.94 Hz	●	●	●	●
		60 Hz	●	●	●	●
8K	7,680 × 4,320	50 Hz	—	—	● ^{*1*}	●
		59.94 Hz	—	—	● ^{*1*}	●
		60 Hz	—	—	● ^{*1*}	●

^{*1}: Uses Mode 2 display mode. ^{*2}: Input 7's A to D connectors each support input signals of 3,840 × 2,160 resolution.

Dimensions

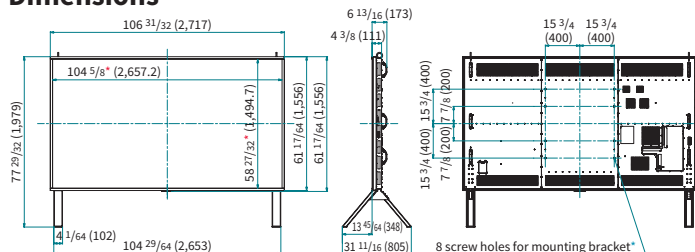

Units: inch (mm)

* Screen dimensions

* To use the mounting bracket, use M8 screws that are 8 to 10 mm plus the thickness of the bracket.

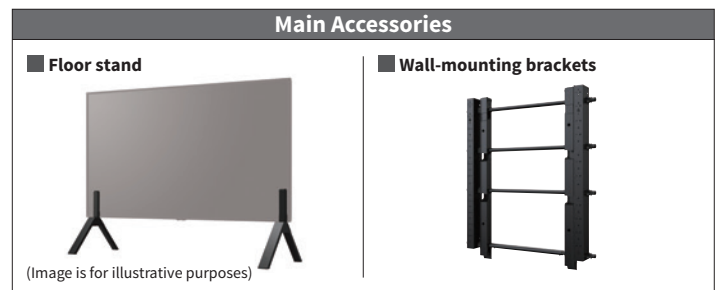
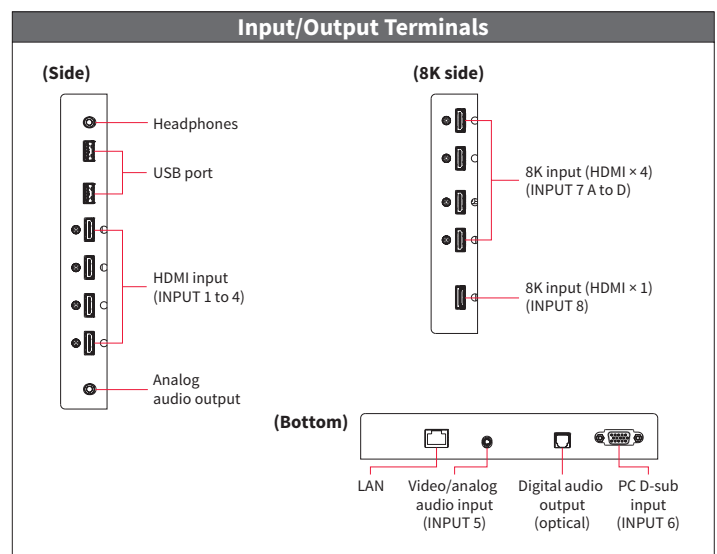

HDMI[™]
HIGH-DEFINITION MULTIMEDIA INTERFACE

DOLBY AUDIO[™]

SHARP[®]

SHARP ELECTRONICS CORPORATION
100 Paragon Drive, Montvale, NJ 07645
1-800-BE-SHARP • www.sharpusa.com

Sharp is a registered trademark of Sharp Corporation. The terms HDMI, HDMI High-Definition Multimedia Interface, and the HDMI Logo are trademarks or registered trademarks of HDMI Licensing Administrator, Inc. Dolby, Dolby Audio, and the double-D symbol are trademarks of Dolby Laboratories. All other brand names and product names may be trademarks or registered trademarks of their respective owners. All screen images appearing in this brochure are simulated. Design and specifications are subject to change without prior notice.