

# Microwave Oven

---

User manual

ME11A7710D\*

---



**SAMSUNG**

# Contents

<b>Important safety instructions</b>	<b>3</b>
--------------------------------------	----------

<b>Setting up your new microwave oven</b>	<b>10</b>
---	-----------

Checking the parts	10
Setting up your microwave oven	11
Learning about the control panel	11
Set Time	12
Set Date	12
Sound	12
System Settings	12
Smart Control	14
Voice Control	14
Auto Connectivity	15

<b>Using your microwave oven</b>	<b>16</b>
----------------------------------	-----------

Turntable (On/Off)	16
Kitchen Timer	16
Child Lock	16
Back Button	17
More/Less Feature	17
Stop Button	17
Eco Mode	17
+30 sec	17
Cooktop Lamp (High/Low/Off)	18
Vent Fan (Boost/High/Medium/Low/Off)	18
Popcorn	18
Reheat	18
Defrost	19
Sensor Cook	20
Auto Cook	21
Microwave	25
Power levels	25
One-stage cooking	25
Multi-stage cooking (maximum of 2 stages)	25

<b>Cookware guide</b>	<b>26</b>
-----------------------	-----------

Recommended cooking utensils	26
Limited use items	26
Not recommended	26
Testing utensils	26

<b>Cooking guide</b>	<b>27</b>
----------------------	-----------

Cooking techniques	27
General cooking recommendations	28
Guide for cooking eggs in your microwave	28
Guide for cooking vegetables in your microwave	28

<b>Cleaning and maintaining your microwave oven</b>	<b>29</b>
---	-----------

Cleaning the exterior	29
Cleaning under your microwave oven	29
Cleaning the control panel	29
Cleaning the door and door seals	29
Cleaning the interior	29
Cleaning the turntable and roller rings	29
Storing and repairing your microwave oven	30
Replacing the cooktop/night light	30
Replacing the oven light	31
Cleaning the grease filter	31
Replacing the charcoal filter	32

<b>Troubleshooting</b>	<b>33</b>
------------------------	-----------

Check points	33
Information codes	37

<b>Appendix</b>	<b>37</b>
-----------------	-----------

Specifications	37
----------------	----

<b>Warranty (USA)</b>	<b>38</b>
-----------------------	-----------

<b>Warranty (CANADA)</b>	<b>40</b>
--------------------------	-----------

## Important safety instructions

---

Congratulations on your new Samsung microwave oven. This manual contains important information on the installation, use and care of your appliance. Please take time to read this manual to take full advantage of your microwave oven's many benefits and features.

## WHAT YOU NEED TO KNOW ABOUT SAFETY INSTRUCTIONS

---

Warnings and Important Safety Instructions in this manual do not cover all possible conditions and situations that may occur. It is your responsibility to use common sense, caution, and care when installing, maintaining, and operating your microwave oven.

## PRECAUTIONS TO AVOID POSSIBLE EXPOSURE TO EXCESSIVE MICROWAVE ENERGY

---

- A. Do not attempt to operate this oven with the door open since open-door operation can result in harmful exposure to microwave energy. It is important not to defeat or tamper with the safety interlocks.
- B. Do not place any object between the oven front face and the door or allow soil or cleaner residue to accumulate on the sealing surface.
- C. Do not operate the oven if it is damaged. It is particularly important that the oven door close properly and that there is no damage to the:
  - 1. Door (bent),
  - 2. Hinges and latches, (broken or loosened),
  - 3. Door seals and sealing surface.
- D. The oven should not be adjusted or repaired by anyone except properly qualified service personnel.

## IMPORTANT SAFETY SYMBOLS AND PRECAUTIONS

---

What the icons and signs in this user manual mean:

 **WARNING**









Hazards or unsafe practices that may result in **severe personal injury or death**.

 **CAUTION**

Hazards or unsafe practices that may result in **minor personal injury or property damage**.

 **CAUTION**

To reduce the risk of fire, explosion, electric shock, or personal injury when using your microwave oven, follow these basic safety precautions.

- |   |  |
|---|--|
|  Do NOT attempt.               |  Unplug the power plug from the wall socket.                  |
|  Do NOT disassemble.           |  Make sure the machine is grounded to prevent electric shock. |
|  Do NOT touch.                 |  Call the service center for help.                            |
|  Follow directions explicitly. |  Note   |

**These warning signs are here to prevent injury to you and others. Please follow them explicitly. After reading this section, keep it in a safe place for future reference.**

**SAVE THESE INSTRUCTIONS**

## Important safety instructions

# CALIFORNIA PROPOSITION 65 WARNING

## WARNING

Cancer and Reproductive Harm - [www.P65Warnings.ca.gov](http://www.P65Warnings.ca.gov)

## WARNING

To reduce risk of burns, electric shock, fire, personal injury or exposure to excessive microwave energy:

1. Read all safety instructions before using the appliance.
2. Read and follow the specific **PRECAUTIONS TO AVOID POSSIBLE EXPOSURE TO EXCESSIVE MICROWAVE ENERGY** on page 3.
3. This appliance must be grounded. Connect only to properly grounded outlets. See Important **Grounding instructions** on page 5 of this manual.
4. Install or locate this appliance only in accordance with the provided installation instructions.
5. Some products such as whole eggs and sealed containers (for example, closed glass jars) can explode if heated rapidly. Never heat them in a microwave oven.
6. Use this appliance only for its intended use as described in the manual. Do not put corrosive chemicals or vapors in or on this appliance. This type of oven is specifically designed to heat, cook, or dry food. It is not designed for industrial or laboratory use.
7. As with any appliance, close supervision is necessary when it is used by children. Keep children away from the door when opening or closing it as they may bump themselves on the door or catch their fingers in the door.
8. Do not operate this appliance if it has a damaged cord or plug, if it is not working properly, or if it has been damaged or dropped.

9. This appliance should be repaired or serviced only by qualified service personnel. Contact the nearest authorized service facility for examination, repair, or adjustment.
10. Do not cover or block any openings on the appliance.
11. Do not tamper with or make any adjustments or repairs to the door.
12. Do not store this appliance outdoors. Do not use this product near water, for example, near a kitchen sink, in a wet basement, near a swimming pool, or similar locations.
13. Do not immerse the cord or plug in water.
14. Keep the cord away from heated surfaces. (including the back of the oven).
15. Do not let the cord hang over the edge of a table or counter.
16. When cleaning surfaces of the door and oven that come together when the door closes, use only mild, nonabrasive soaps, or detergents applied with a sponge or soft cloth. Unplug the plug before cleaning.
17. To reduce the risk of fire in the oven cavity:
  - a. Do not overcook food. Carefully attend the appliance when paper, plastic, or other combustible materials are placed inside the oven to facilitate cooking.
  - b. Remove wire twist-ties from paper or plastic bags before placing the bags in the oven.
  - c. If materials inside the oven ignite, keep the oven door closed, turn the oven off, and disconnect the power cord, or shut off the power at the fuse or circuit breaker panel. If the door is opened, the fire may spread.
  - d. Do not use the cavity for storage purposes. Do not leave paper products, cooking utensils, or food in the cavity when not in use.
18. Liquids, such as water, milk, coffee, or tea can be overheated beyond the boiling point without appearing to be boiling. Visible bubbling or boiling when the container is removed from the microwave oven is not always present. **THIS COULD RESULT IN VERY HOT LIQUIDS SUDDENLY BOILING OVER WHEN THE CONTAINER IS DISTURBED OR A SPOON OR OTHER UTENSIL IS INSERTED INTO THE LIQUID.** To reduce the risk of injury:
  - a. Do not overheat liquid.
  - b. Stir liquid both before and halfway through heating it.
  - c. Do not use straight-sided containers with narrow necks.

## SAVE THESE INSTRUCTIONS

- d. After heating, allow the container to stand in the microwave oven for a short time before removing the container.
  - e. Use extreme care when inserting a spoon or other utensil into the container.
19. Oversized foods or oversized metal utensils should not be inserted into the microwave oven as they may cause a fire or risk of electric shock.
  20. Do not clean the microwave with a metal scouring pad. A piece of metal could come off the pad, contact electrical parts, and cause an electric shock.
  21. Do not put paper products into the oven when you are operating it in the toaster mode.
  22. Do not store any materials, other than manufacturer's recommended accessories, in this oven when not in use.
  23. Do not cover the racks or any other part of the oven with metal foil. This will cause the oven to overheat.

## CAUTION

1. Clean Ventilating Hoods Frequently - Grease should not be allowed to accumulate on the hood of the filter.
2. When flaming foods under the hood, turn the fan on.
3. Use care when cleaning the vent-hood filter. Corrosive cleaning agents, such as lye-based oven cleaner, may damage the filter.

## GROUNDING INSTRUCTIONS

This appliance must be grounded. In the event of an electrical short circuit, grounding reduces the risk of electric shock by providing an escape wire for the electrical current. This appliance is equipped with a cord that includes a grounding wire and a grounding plug. The plug must be plugged into an outlet that is properly installed and grounded.

## WARNING

Improper use of the grounding plug can result in a risk of electric shock.

- Plug into a grounded, 3 pronged outlet. Do not remove the third (grounding) prong. Do not use an adaptor or otherwise thwart the safety function of the grounding plug.
- Consult a qualified electrician or service person if you do not understand the grounding instructions or if you are not sure if the appliance is properly grounded.
- We do not recommend using an extension cord with this appliance. If the power-supply cord is too short, have a qualified electrician or serviceman install an outlet near the appliance. However, if it is necessary to use an extension cord, read and follow the "Use of Extension Cords" section below.

## USE OF EXTENSION CORDS

A short power-supply cord is provided to reduce the risk of your becoming entangled in or tripping over a longer cord. Longer cord sets or extension cords are available and you can use them if you exercise care. If you use a long cord or an extension cord:

1. The marked electrical rating of the cord set or extension cord should be at least as great as the electrical rating of the appliance.
2. The extension cord must be a grounding-type 3-wire cord and it must be plugged into a 3-slot outlet.
3. The longer cord should be arranged so that it will not drape over the counter top or tabletop where it can be pulled on by children or tripped over accidentally. If you use an extension cord, the interior light may flicker and the speed of the blower may vary when the microwave oven is on. Cooking times may be longer too.

## SAVE THESE INSTRUCTIONS

## Important safety instructions



### **CRITICAL INSTALLATION WARNINGS**

-  This appliance must be installed by a qualified technician or service company.
    - Failing to have a qualified technician install the oven may result in electric shock, fire, an explosion, problems with the product, or injury.Unpack the oven, remove all packaging material and examine the oven for any damage such as dents on the interior or exterior of the oven, broken door latches, cracks in the door, or a door that is not lined up correctly. If there is any damage, do not operate the oven and notify your dealer immediately.
- Make sure to install your oven in a location with adequate space. Remove all foreign substances such as dust or water from the power plug terminals and contact points using a dry cloth on a regular basis.
- Unplug the power plug and clean it with a dry cloth.
  - Failing to do so may result in electric shock or fire.
- Plug the power cord into a properly grounded 3 pronged outlet. Your oven should be the only appliance connected to this circuit.
- Sharing a wall socket with other appliances, using a power strip, or extending the power cord may result in electric shock or fire.
  - Do not use an electric transformer. It may result in electric shock or fire.
  - Ensure that the voltage, frequency and current provided match the product's specifications. Failing to do so may result in electric shock or fire.
- Keep all packaging materials out of the reach of children. Children may use them for play.

-  This appliance must be properly grounded. Read and follow the specific "Grounding instructions" found in the beginning of this section. Do not ground the appliance to a gas pipe, plastic water pipe, or telephone line.
  - This may result in electric shock, fire, an explosion, or problems with the product.
  - Never plug the power cord into a socket that is not grounded correctly and make sure that it is grounded in accordance with local and national codes.



Do not cut or remove the third (ground) prong from the power cord under any circumstances.

The microwave requires a separate branch circuit single grounded outlet of at least 15A and max of 20A.

-  Do not install this appliance in a humid, oily, or dusty location, or in a location exposed to direct sunlight or water (rain drops).
  - This may result in electric shock or fire.Plug the power plug into the wall socket firmly. Do not use a damaged power plug, damaged power cord, or loose wall socket.
  - This may result in electric shock or fire.Do not mount over a sink.
- Do not pull or excessively bend the power cord.
- Do not twist or tie the power cord.
- Do not hook the power cord over a metal object, place a heavy object on the power cord, insert the power cord between objects, or push the power cord into the space behind the appliance.
  - This may result in electric shock or fire.Do not pull the power cord when you unplug the oven.
  - Unplug the oven by pulling the plug only.
  - Failing to do so may result in electric shock or fire.
-  If the power plug or power cord is damaged, contact your nearest service center for a replacement or repair.

## SAVE THESE INSTRUCTIONS

## INSTALLATION CAUTIONS

-  Position the oven so that the plug is easily accessible.
  - Failing to do so may result in electric shock or fire due to electric leakage.
-  Unplug the oven when it is not being used for long periods of time or during a thunder/lightning storm.
  - Failing to do so may result in electric shock or fire.

## CRITICAL USAGE WARNINGS

-  If the microwave appliance is flooded, please contact your nearest Samsung service center. Failing to do so may result in electric shock or fire. Read and follow the specific “Precautions to Avoid Possible Exposure to Excessive Microwave Energy”, found in the beginning of this Safety Information Section.
 

If the microwave generates a strange noise, a burning smell or smoke, unplug it immediately and contact your nearest Samsung service center.

  - Failing to do so may result in electric shock or fire.

In the event of a gas leak (propane gas, LP gas, etc.), ventilate the room immediately. Do not touch the microwave, power cord, or plug.

  - Do not use a ventilating fan.
  - A spark may result in an explosion or fire.



Take care that the door or any of the other parts do not come into contact with your body while the microwave is cooking or just after cooking.

  - Failing to do so may result in burns.

-  In the event of a grease fire on the surface units below the microwave oven, smother the flaming pan on the surface unit by covering the pan completely with a lid, a cookie sheet, or a flat tray.
 

Never leave surface units beneath your microwave oven unattended at high heat settings. Boil overs cause smoking and greasy spillovers that may ignite and spread if the vent fan is operating. To minimize automatic fan operation, use adequate sized cookware and use high heat on surface units only when necessary.

If materials inside the microwave oven should ignite, keep the oven door closed, turn the oven off and disconnect the power cord, or shut off power at the fuse or circuit breaker panel. If the door is opened, the fire may spread.

  - Always observe safety precautions when using your microwave oven. Never try to repair the oven on your own. There is dangerous voltage inside. If the oven needs to be repaired, contact an authorized service center near you.
-  Do not attempt to repair, disassemble, or modify the appliance yourself.
  - Because a high voltage current enters the product chassis during operation, opening the chassis can result in electric shock or fire.
  - You may be exposed to electromagnetic waves.
  - If your microwave oven requires repair, contact your nearest Samsung service center.
-  If any foreign substance such as water enters the microwave, unplug it, and then contact your nearest service center.
  - Failing to do so may result in electric shock or fire.

**SAVE THESE INSTRUCTIONS**

## Important safety instructions

- ❑ Do not touch the power plug with wet hands.
    - This may result in electric shock.
  - Do not turn the appliance off by unplugging the power plug while the appliance is in operation.
  - Plugging the power plug into the wall socket again may cause a spark and result in electric shock or fire.
- Keep all packaging materials well out of the reach of children. Packaging materials can be dangerous to children.
- If a child places a bag over its head, the child can suffocate.
- Do not let children or any person with reduced physical, sensory or mental capabilities use this appliance unsupervised. Make sure that the appliance is out of the reach of children.
- Failing to do so may result in electric shock, burns, or injury.
- Do not touch the inside of the appliance immediately after cooking. The inside of the appliance will be hot.
- The heat on the inside of your microwave oven can cause burns.
- Do not put aluminum foil (except as specifically directed in this manual), metal objects (such as containers, forks, etc.), or containers with golden or silver rims into the microwave.
- These objects can cause sparks or a fire.
- Do not use or place flammable sprays or objects near the microwave oven.
- Heat from the microwave can cause flammable sprays to explode or burn.
  - Failing to do so may result in electric shock or injury.
- Do not tamper with or make any adjustments or repairs to the door. Under no circumstances should you remove the outer cabinet.
- Do not store or use your microwave oven outdoors.

## USAGE CAUTIONS

- ★ If the surface of the microwave is cracked, turn it off.
  - Failing to do so may result in electric shock.Dishes and containers can become hot. Handle with care. Hot foods and steam can cause burns. Carefully remove container coverings, directing steam away from your hands and face. Remove lids from baby food before heating. After heating baby food, stir well to distribute the heat evenly. Always test the temperature by tasting before feeding the baby. The glass jar or surface of the food may appear to be cooler than the food in the interior, which can be so hot that it will burn the infant's mouth. Make sure all cookware used in your microwave oven is suitable for microwaving. Use microwavable cookware in strict compliance with such manufacturer's recommendations.
- ❑ Do not stand on top of the microwave or place objects (such as laundry, oven covers, lighted candles, lighted cigarettes, dishes, chemicals, metal objects, etc.) on the appliance.
  - Items, such as a cloth, may get caught in the door.
  - This may result in electric shock, fire, problems with the product, or injury.Do not operate the appliance with wet hands.
  - This may result in electric shock.Do not spray volatile material such as insecticide onto the surface of the appliance.
  - As well as being harmful to humans, it may also result in electric shock, fire or problems with the product.Do not place the appliance over a fragile object such as a sink or glass object.
  - This may result in damage to the sink or glass object.

**SAVE THESE INSTRUCTIONS**



- 
- ☒ Do not put your face or body close to the appliance while it is cooking or when opening the door just after cooking.
- Take care that children do not come too close to the appliance.
  - Failing to do so may result in children burning themselves.
- Do not place food or heavy objects over the door.
- When you open the door, the food or object may fall and this may result in burns or injury.
- Do not abruptly cool the door, the inside of the appliance, or the dish by pouring water over it during or just after cooking.
- This may result in damage to the appliance. The steam or water spray may result in burns or injury.
- Do not cook without the glass tray in place on the oven floor. Food will not cook properly without the tray.
- Do not defrost frozen beverages in narrow-necked bottles. The containers can break.
- Do not scratch the glass of your microwave oven door with a sharp object.
- This may result in the glass being damaged or broken.
- Do not store anything directly on top of the appliance when it is in operation.
- Do not use sealed containers. Remove seals and lids before use. Sealed containers can explode due to buildup of pressure even after the oven has been turned off.

---

## **⚠ CRITICAL CLEANING INSTRUCTIONS**

---

Do not clean the appliance by spraying water directly onto it.  
Do not use benzene, thinner, or alcohol to clean the appliance.

- This may result in discoloration, deformation, damage, electric shock, or fire.
- Before cleaning or performing maintenance, unplug the appliance from the wall socket. Then, remove food waste from the door and cooking compartment.

- Failing to do so may result in electric shock or fire.

Take care not to hurt yourself when cleaning the appliance.  
(external/internal)

- You may hurt yourself on the sharp edges of the appliance.

Do not clean the appliance with a steam cleaner.

- This may result in corrosion.

Keep the inside of your microwave oven clean. Food particles or spattered oils stuck to the oven walls or floor can cause paint damage and reduce the efficiency of the oven.

**SAVE THESE INSTRUCTIONS**

# Setting up your new microwave oven

Be sure to follow these instructions closely so that your new microwave oven works properly.

## Checking the parts

Carefully unpack your microwave oven, and make sure you've received all the parts shown below. If your microwave oven was damaged during shipping, or if you do not have all the parts, contact the Samsung Call Center.

(Refer to the **WARRANTY AND SERVICE INFORMATION** on page 38.)

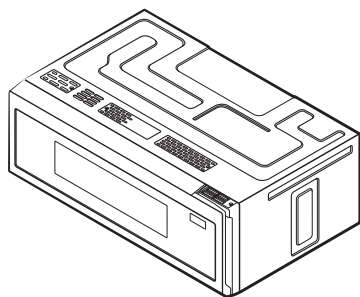

Microwave oven

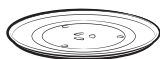

\* Glass tray



\* Roller guide ring

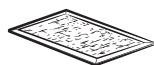

\* Grease Filters (2ea)

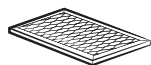

\* Charcoal filters (2ea)

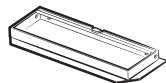

\* Exhaust adaptor



\* Hardware kit  
(Screws & Brackets)

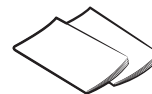

Manuals  
(User & Installation)

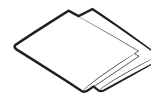

Templates  
(Top & Wall)

### NOTE

If you need an accessory marked with an \* (asterisk), please contact the Samsung Call Center using the phone number listed on the last page of this manual or visit our on-line parts web site at [www.samsungparts.com](http://www.samsungparts.com).

## Setting up your microwave oven

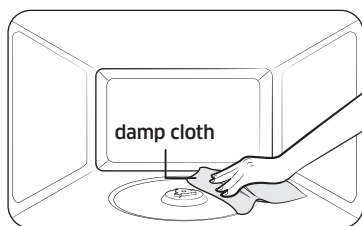

1. Open the door by pulling the handle on the right side of the door.
2. Wipe the inside of your microwave oven with a damp cloth.

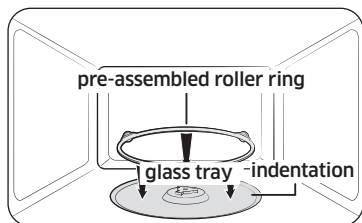

3. Install the pre-assembled ring into the indentation at the center of the microwave oven.

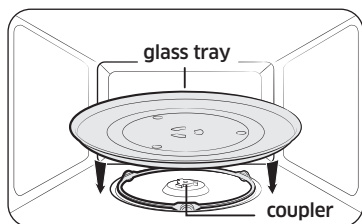

4. Fit the center of the glass tray to the coupler.

## Learning about the control panel

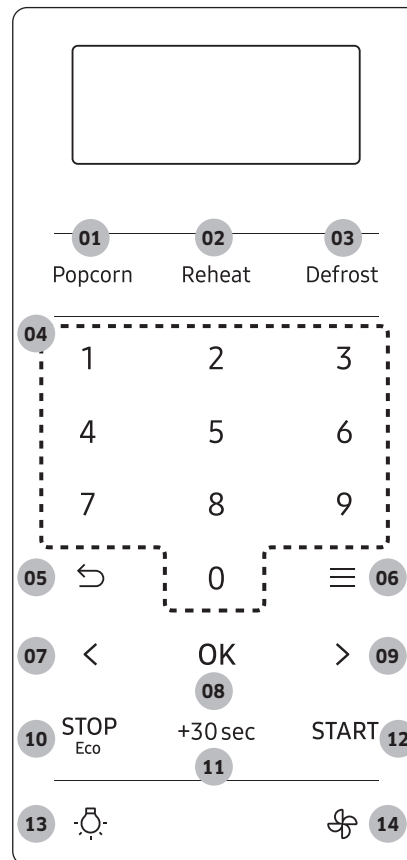

- 01 Popcorn Button
- 02 Reheat Button
- 03 Defrost Button
- 04 Number Pad
- 05 Back Button
- 06 More Functions Button
- 07 Left Button
- 08 OK Button
- 09 Right Button
- 10 STOP Eco Button
- 11 +30sec Button
- 12 START Button
- 13 Light Button (Hi/Low/Off)
- 14 Vent Button(4 Speed & On/Off)

# Setting up your new microwave oven

## Set Time

Your microwave oven is equipped with a built-in clock. Set the clock when first installing your microwave oven and after a power failure. The time is displayed whenever the microwave oven is not being used.

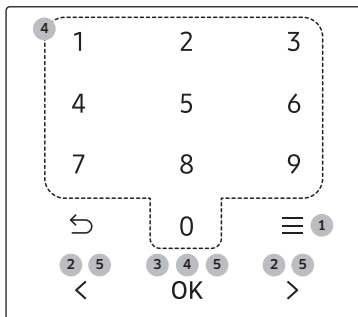

1. Touch the **More Functions** button.
2. Touch < or > button until display shows **Set Time**.
3. Touch the **OK** button.
4. Use the **numeric** buttons to enter hour, touch **OK** button, use **numeric** buttons again to enter minutes and then touch **OK** button.
5. For 12 hour display mode, touch < or > button to set AM or PM and then touch **OK** button.

## Set Date

Set the date when first installing your microwave oven and after a power failure.

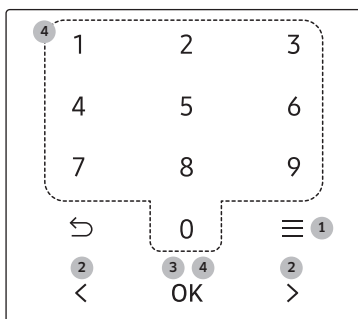

1. Touch and hold the **More Functions** button.
2. Touch < or > button until display shows **Set Date**.
3. Touch the **OK** button.
4. Use the **numeric** buttons to enter the month, touch **OK** button, use **numeric** buttons to enter day, touch **OK** button, use **numeric** buttons again to enter year and then touch **OK** button.

## Sound

You can turn the sound on or off.



1. Touch and hold the **More Functions** button.
2. Touch < or > button until display shows **Sound**.
3. Touch the **OK** button.
4. Use < or > button to select a setting.
5. Touch the **OK** button.

## System Settings

You can customize your new microwave oven to suit your preferences.

To customize:

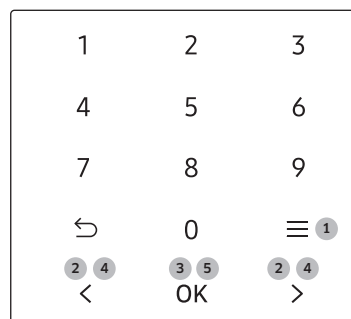

1. Touch and hold the **More Functions** button until display shows **System Settings**.
2. Touch < or > button to select a function you want to customize.
3. Touch the **OK** button.
4. Touch < or > button to select a setting.
5. Touch the **OK** button.

The functions and options are listed in the table below.

No.	Function	Description	Options
1	Wi-Fi	The Wi-Fi function can be turned on and off.	On Off
2	Screen time out	Screen time out options are 5 min, 10 min, 15 min and always on.	5 min 10 min 15 min Always On
3	Time Format	The clock can display in either the 12 hr or 24 hr time mode.	12 hr 24 hr
4	Weight Unit	Weight option can display in either pounds or kilograms.	lb kg
5	Remind End Signal	The remind end signal can be turned on and off.	On Off
6	Daylight Saving Time	The time can be advanced one hour for DST without resetting the clock.	On(to advance one hour) Off(to go back one hour)
7	Filter Remind	The filter remind function can be turned on and off.	On Off
8	My Pattern	The my pattern function can be turned on and off. It will let you see the most used cooking mode first on the display.	On Off
9	Demo mode	The demo mode can be turned on and off.	On Off
10	Reset	You can reset the settings of you microwave oven.	Reset

#### NOTE

- If you change your mind while adjusting a setting, touch the ↶ button to go back, and then adjust the setting again.
- If there is a power interruption, you will need to reset these options.
- If the clock is set for standard time, the **Daylight Savings Time Adjustment** function allows you to change the time easily without needing to reset the clock. **Daylight Saving Time** begins for most of the United States at 2 a.m. on the first Sunday of April and reverts to Standard time at 2 a.m. on the last Sunday of October.
- If the **Filter Remind** function is **ON**, the microwave will remind you to clean or replace the grease filter every four months. When it is time to clean or replace the grease filter, the microwave displays the "Filter" message to remind you to clean or replace the grease filter. To remove the message, touch the number 0 when the microwave is in standby mode. If you don't want to receive this message, set the **Filter Remind** function off in **Options**.

# Setting up your new microwave oven

## Smart Control

To use the microwave oven's Smart Control, you must download the SmartThings app to a mobile device. Functions operated by the SmartThings app may not work smoothly if communication conditions are poor or the microwave oven is installed in a place with a weak Wi-Fi signal.

### How to connect the microwave oven

1. Download and open the SmartThings app on your smart device.
2. Follow the app's on-screen instructions to connect your microwave oven.
3. To operate smart control function from the microwave oven, touch and hold **OK** button for 3 seconds.
4. Once the process is complete, the  icon appears on your microwave oven display and the app will confirm you are connected.
5. If the connection icon does not turn on, follow the instruction on the app to reconnect.

Microwave Oven remote control using the SmartThings app	
Microwave Oven Monitoring	Check the status of the microwave oven
Microwave Oven Remote Control	Remotely control vent fan speed/cooktop lamp

### NOTE

For safety reasons, you cannot turn on the microwave oven remotely and you must specify the cooking time to enable remote control. Smart Control will not work properly if the Wi-Fi Connection is unstable.

## Voice Control

To use the microwave oven's Voice Control function, you need Bixby / Amazon Alexa App / Google Assistant App on your mobile device.

### Bixby

Start conversation with Bixby on SAMSUNG mobile by saying "Hi Bixby" or by pressing the side key.

Function	"Hi Bixby"
Turn Off/Stop	<ul style="list-style-type: none"><li>• Cancel the microwave</li><li>• Turn off the microwave</li></ul>
Check Time	<ul style="list-style-type: none"><li>• Check the remaining time of the microwave</li><li>• How much time is left on the microwave timer?</li></ul>
Check Status	<ul style="list-style-type: none"><li>• Check the microwave status</li><li>• Check the status of the microwave</li></ul>
MW Hood Control	<ul style="list-style-type: none"><li>• Turn on/off the microwave hood light</li><li>• Trun on/off hood power of microwave</li><li>• Turn on/off hood fan of microwave</li><li>• Set the microwave hood fan speed to high/mid/low</li></ul>

### Amazon Alexa & Google Assistant

Samsung smart home appliances are supported by SmartThings skill in Alexa & action in Google Assistant.

### Installation Guide

Here's how to link SmartThings account into Amazon Alexa or Google Assistant. SmartThings App and Alexa App(or Google Assistant App) Should be installed on your phone.

1. Setup the supported devices to SmartThings.
2. After device setup, tap **+** button on the screen.

3. Tap 'Voice assistant' and link your Samsung account to Amazon Alexa. (or Google Assistant)
4. Check the devices are visible on Amazon Alexa app. Then account linking is complete. (Check the devices are visible and set the location(home&room) of devices in Google home app. Then account linking is complete.)

Function	"Alexa"	"Ok Google"
Turn Off/ Stop	<ul style="list-style-type: none"> <li>• Turn off the microwave</li> <li>• Stop the microwave</li> </ul>	<ul style="list-style-type: none"> <li>• Turn off the microwave</li> <li>• Stop the microwave</li> </ul>
Pause	<ul style="list-style-type: none"> <li>• Pause the microwave</li> </ul>	<ul style="list-style-type: none"> <li>• Pause the microwave</li> </ul>
Check Status	<ul style="list-style-type: none"> <li>• Is the microwave running?</li> <li>• Is the microwave on?</li> </ul>	<ul style="list-style-type: none"> <li>• Is the microwave running?</li> <li>• Is the microwave on?</li> </ul>
MW Hood Control	<ul style="list-style-type: none"> <li>• Turn on/off the (hood light, hood lamp, lamp, light) on microwave</li> <li>• Turn on/off the (hood light, hood lamp)</li> <li>• Set the microwave (brightness, light level, lamp level) to [low, high]</li> <li>• Turn on/off the (hood, fan, hood fan) on microwave[device name]</li> <li>• Turn on/off the (hood, hood fan)</li> <li>• Set the microwave (hood, fan, hood fan) speed to [low, medium, high]</li> </ul>	<ul style="list-style-type: none"> <li>• Turn on/off the microwave (light, lamp)</li> <li>• Turn on/off the (hood light, hood lamp)</li> <li>• Set the microwave (brightness, light level, lamp level) to [low, high]</li> <li>• Turn on/off the (hood, fan, hood fan) on microwave</li> <li>• Turn on/off the (hood, hood fan)</li> <li>• Set the microwave (hood, fan, hood fan) speed to [low, medium, high]</li> </ul>

 **NOTE**

For safety reasons, you cannot turn on the microwave oven remotely.

## Auto Connectivity

Auto Connectivity function lets you quickly connect the hood via Wi-Fi with a compatible Samsung cooktop after the hood and cooktop have been paired. To turn the function on, press the Auto Connectivity button in SmartThings App. To disconnect the hood and cooktop, press the Auto Connectivity button again. While the hood and cooktop are connected, the hood fan will automatically turn on when you turn on the cooktop.

The hood fan will also turn off automatically when you turn off the cooktop.

 **NOTE**

Auto connectivity function may not work normally when the temperature is set high.

# Using your microwave oven

## Turntable (On/Off)

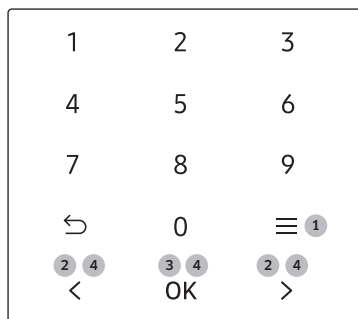

1. Touch the **More Functions** button.
2. Touch < or > button until display shows **Turn Table**.
3. Touch the **OK** button.
4. Touch < or > and then touch **OK** button to set the function on/off.

### NOTE

You can use this feature only on manual cooking mode. If the turntable does not rotate for an extended period of time, food may burn. For best cooking results, leave the turntable feature on.

### CAUTION

The turntable may become too hot to touch. Use pot holders to handle the turntable during and after cooking.

## Kitchen Timer

Your microwave has a built-in timer function - the **Kitchen Timer**. Use the Kitchen Timer for timing up to 99 minutes, 99 seconds.

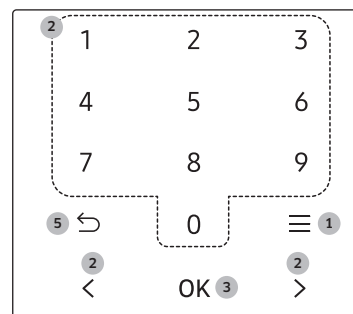

1. Touch the **More Functions** button.
2. Touch < or > button until display shows **Timer** and then use **numeric** buttons to set the time.
3. Touch the **OK** button.
4. The display counts down, and then beeps when the time has elapsed.
5. To cancel the timer setting, touch the  button.

## Child Lock

The **Child Lock** function allows you to lock all buttons so that the microwave oven cannot be operated by children accidentally.

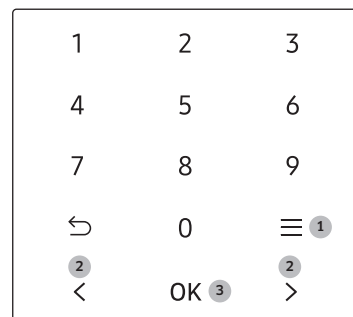

### Activating

1. Touch the **More Functions** button.
2. Touch < or > button until display shows **Lock**.
3. Touch the **OK** button.



### Deactivating

1. Touch and hold the **More Functions** button until the lock function is deactivated.



## Back Button

The  button allows you to un-do the action you have just entered.

- To un-do the action you have just entered, touch the  button and then re-enter the instructions.
- To cancel a timer setting, touch the  button.

## More/Less Feature

The more/less feature allows you to adjust the cooking time during manual cooking mode.



1. To add more cooking time during manual cooking mode, touch the **>** button. Each time you touch the **>** button, cooking time will be increased by 10 seconds.
2. To reduce cooking time during manual cooking mode, touch the **<** button. Each time you touch the **<** button, cooking time will be decreased by 10 seconds.

## Stop Button

The **STOP** button allows you to clear instructions you have entered.

It also allows you to pause your microwave oven's cooking cycle, so that you can check the food.

- To pause the oven during cooking, touch the **STOP** button once. To restart, touch the **START** button.
- To stop cooking, erase instructions, and return the oven display to the time of day, touch the **STOP** button twice.

## Eco Mode

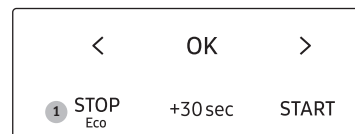

Eco Mode reduces standby power usage. When you touch the **STOP Eco** button once, the display will go out and the microwave shifts to a mode which minimizes power usage. To cancel the Eco mode, touch any other button.

## +30 sec

This feature offers a convenient way to increase cooking time in manual cooking mode.

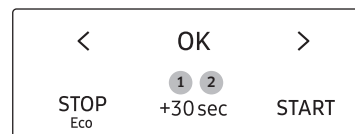

1. In standby mode, touching **+30 sec** button will add 30 seconds of microwave mode.
2. If the oven is in manual cooking mode, touching **+30 sec** button will add cooking time by 30 seconds.

# Using your microwave oven

## Cooktop Lamp (High/Low/Off)

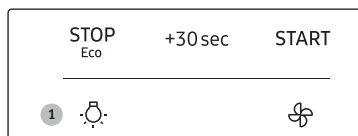

Touch the button to turn the cooktop lamp on or off. Touch the button once for high, twice for low and three times to turn the cooktop lamp off.

## Vent Fan (Boost/High/Medium/Low/Off)

The vent fan removes steam and other vapors that result from cooking on the cooktop below.

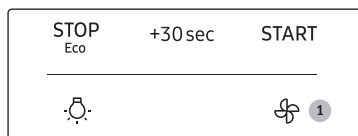

Touch the button once for boost fan, twice for high fan, three times for medium fan and four times for low fan speed. Touch the button five times to turn the fan off.

### NOTE

The exhaust fan's speed may decrease when the oven's cooking function is activated.

### NOTE

The Vent Fan protects the microwave from excess heat. It automatically turns on if it senses too much heat. If you have turned the fan on, you may find that you cannot turn it off. The fan will automatically turn off when the internal parts are cool. It may stay on for 30 minutes or more after the cooktop and microwave controls are turned off.

## Popcorn

You can cook popcorn easily using the Popcorn button. You do not need to set either the cooking time or the power level.

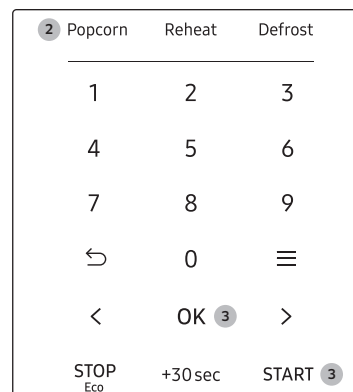

1. Put a bag of unpopped popcorn on the tray.
2. Touch the **Popcorn** button.
3. Touch **OK** or **START** button. The microwave oven will automatically operate by sensing the popcorn inside. (3-3.5 OZ)

## Reheat

You can reheat foods easily using the Reheat button. You do not need to set either the cooking time or the power level.

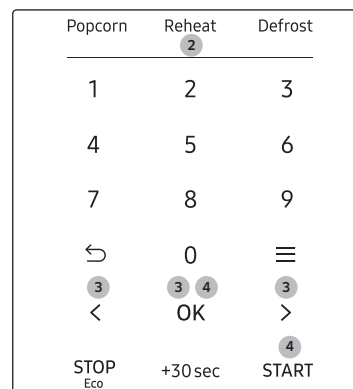

1. Put the food on the tray.
2. Touch **Reheat** button.
3. Touch **OK** and select food item by touching < or > button.
4. Touch **OK** or **START** button. The microwave oven will automatically operate by sensing the food inside.

Food	Amount	Instructions
Pizza	1-4 slices	Place 1-4 pizza slices on a microwave-safe plate with the wide ends of the slices towards the outside edge of the plate. Do not let the slices overlap. Do not cover. Let the microwave oven cool for at least 5 minutes before using it again.
Casserole	1-4 servings	Cover the plate with vented (1 inch vent) plastic wrap. If the food is not as hot as you would like after using the function, continue heating using additional time and power. Stir the food once before serving. Contents: Casseroles (refrigerated)
Dinner plate	1 servings	Use only precooked, refrigerated foods. Cover the plate with vented (1 inch vent) plastic wrap or waxed paper tucked under the plate. If the food is not as hot as you would like after using the function, continue heating using additional time and power. Contents: <ul style="list-style-type: none"> <li>• 3-4 oz, meat, poultry or fish (up to 6 oz. with bone)</li> <li>• ½ cup starch (potatoes, pasta, rice, etc.)</li> <li>• ½ cup vegetables (about 3-4 oz.)</li> </ul>
Pasta	1-4 servings	Cover the plate with vented (1 inch vent) plastic wrap. If the food is not as hot as you would like after using the function, continue heating using additional time and power. Stir the food once before serving. Contents: Pasta (canned spaghetti)

## Defrost

To thaw frozen foods, enter the weight of the food, and the microwave automatically sets the defrosting time, power level, and standing time.

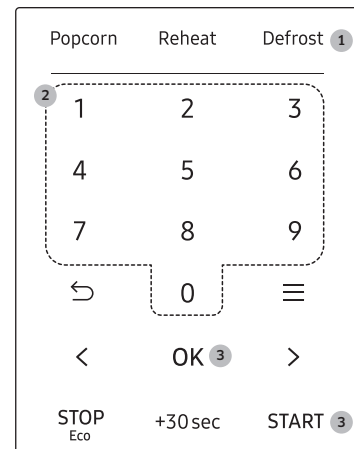

1. Touch the **Defrost** button.
2. Touch the **numeric** buttons to directly enter the weight of the food. (0.1-6.0 lbs. See the table at the beginning of the next page.)
3. Touch **OK** or **START** button.
4. The oven will beep and the display will show **Turn the food over** during the defrosting process. Open the oven door, and turn the food over. If you do not turn the food over when **Turn the food over** is displayed, the microwave will continue until the end of cooking time.

## Using your microwave oven

Follow the instructions below when defrosting different types of food.

Food	Amount	Instructions
Meat	0.1-6.0 lbs. 0.1-2.7 kg	Shield the edges with aluminium foil. Turn the meat over when the oven beeps. This program is suitable for lamb, pork, steaks, chops, and ground meat. Let stand, covered with foil for 5-10 minutes.

### NOTE

Check the food when you hear the oven signal. After the final stage, small sections may still be icy; let them stand to continue the thawing process. The food is not defrosted until all ice crystals have melted. Shielding roasts and pieces of steak using small pieces of foil prevents the edges from being cooked before the center of the food has defrosted. Use narrow, flat, smooth strips of aluminum foil to cover edges and thinner sections of the food.

### Sensor Cook

The Sensor Cook buttons lets you cook favorite foods using preset power levels and times. If the food is not thoroughly cooked after using Sensor Cook feature, complete the cooking process by cooking the food for an additional amount of time.

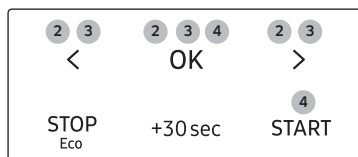

1. Put the food on the tray.
2. Touch < or > button until display shows **Sensor Cook** and then touch **OK** button.
3. Select the food item you want by touching <, > and **OK** button.
4. Touch **OK** or **START** button to start cooking. The microwave oven will automatically operate by sensing the food inside.

Category	Food	Amount	Instructions
Potatoes	Potatoes	1-6 potatoes.	Pierce each potato several times with a fork. Place on the turntable in a spoke-like fashion. After cooking, let the potatoes stand for 3-5 minutes. Let the microwave oven cool for at least 5 minutes before using it again.
Cook	Beverage	8 oz, 1 cup	Use a measuring cup or mug and do not cover. Place the beverage in the microwave oven. After heating, stir well. Let the microwave oven cool for at least 5 minutes before using it again.
	Frozen breakfast	4-8 oz.	Use for frozen sandwiches, breakfast entrees, pancakes, waffles, etc. Follow the package instructions for covering and standing. Let the microwave oven cool for at least 5 minutes before using it again.
	Chicken breasts	8-24 oz.	Pierce the chicken breasts 3 times with a knife. Place the chicken breasts on the microwave safe dish. Cover with vented (1 inch vent) plastic wrap while cooking and stir before letting stand. Let the microwave oven cool for at least 5 minutes before using it again.
	Frozen dinner	12-16 oz.	Remove the food from its wrapping and follow the instructions on the box for covering and letting stand. Let the microwave oven cool for at least 5 minutes before using it again.

Category	Food	Amount	Instructions
Veggies	Fresh vegetables	1-4 servings	Place the fresh vegetables (broccoli florets, cauliflower florets, zucchini, eggplants etc.) in a microwave safe ceramic, glass, or plastic dish and add 1-4 tbs. water. Cover with vented (1 inch vent) plastic wrap while cooking and stir before letting stand. Let the microwave oven cool for at least 5 minutes before using it again.
	Frozen vegetables	1-4 servings	Place the frozen vegetables in a microwave safe ceramic, glass, or plastic dish and add 1-4 tbs. water. Cover with vented (1 inch vent) plastic wrap while cooking and stir before letting stand. Let the microwave oven cool for at least 5 minutes before using it again.

## Auto Cook

The Auto Cook button lets you cook favorite foods using preset power levels and times. If the food is not thoroughly cooked after using Auto Cook feature, complete the cooking process by cooking the food for an additional amount of time.

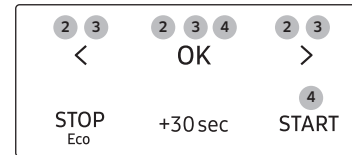

1. Put the food on the tray.
2. Touch < or > button until display shows **Auto Cook** and then touch **OK** button.
3. Select the food item you want by touching <, > and **OK** button.
4. Select the amount of food by touching < and > button.
5. Touch **OK** or **START** button to start cooking. The microwave oven will automatically operate by pre-programmed time.

## Using your microwave oven

Category	Menu	Amount	Instructions
Snack	Fish sticks	1 serving	Place the fish sticks on the microwave safe dish. Place the dish on the center of the turntable.
		2 servings	
	Quesadillas	1 serving	Follow the package directions. Place the quesadilla on the microwave safe dish. Place the dish on the center of the turntable.
		2 servings	
	Hot dogs	2 each	Pierce the hot dogs 3 times with a fork. Place the hot dogs on the microwave safe dish. Place the dish on the center of the turntable. When the microwave beeps, add the buns and restart the microwave. For the best texture, the buns should be added after the microwave beeps.
		4 each	
	Instant macaroni and cheese	1 serving	Follow the package directions. Place the dish on the center of the turntable. Stir afterwards.
		2 servings	
	Frozen waffles	1 serving	Place the waffles on the microwave safe dish. Place the dish on the center of the turntable.
		2 servings	
Frozen croquettes	1 serving	Place the croquettes on the microwave safe dish. Place the dish on the center of the turntable.	
	2 servings		
Burritos	1 each	Follow the package directions. Place the burrito on the microwave safe dish. Place the dish on the center of the turntable.	
	2 each		
Instant mashed potatoes	2 servings	Follow the package directions. Place the dish on the center of the turntable. Stir afterwards.	
	4 servings		

Category	Menu	Amount	Instructions
Fresh Vegetables	Broccoli	1 serving	Wash and clean the broccoli. Place the broccoli florets in the microwave safe bowl. Add 1-4 tbs. of water (1 tbs. per serving). Cover with vented (1 inch vent) plastic wrap while cooking and stir before letting stand.
		2 servings	
		3 servings	
		4 servings	
	Carrots	1 serving	Wash and clean the carrots. Cut the carrots into even slices and place in the microwave safe bowl. Add 1-4 tbs. of water (1 tbs. per serving). Cover with vented (1 inch vent) plastic wrap while cooking and stir before letting stand.
		2 servings	
		3 servings	
		4 servings	
	Green beans	1 serving	Wash and clean the green beans. Place the green beans in the microwave safe bowl. Add 1-4 tbs. of water (1 tbs. per serving). Cover with vented (1 inch vent) plastic wrap while cooking and stir before letting stand.
		2 servings	
		3 servings	
		4 servings	
Spinach	1 serving	Wash and clean the spinach. Place the spinach in a microwave safe bowl. Add 1-4 tbs. of water (1 tbs. per serving). Cover with vented (1 inch vent) plastic wrap while cooking and stir before letting stand.	
	2 servings		
	3 servings		
	4 servings		
Squash	2 servings	Slice the squash in half and remove the seeds. Place the squash cut side down in a microwave safe dish and add ¼ cup of water. Cover with vented (1 inch vent) plastic wrap while cooking and stir before letting stand.	
	4 servings		

Category	Menu	Amount	Instructions
Frozen Vegetables	Broccoli	1 serving	Place the broccoli in the microwave safe bowl. Add 1-4 tbs. of water (1 tbs. per serving). Cover with vented (1 inch vent) plastic wrap while cooking and stir before letting stand.
		2 servings	
		3 servings	
		4 servings	
	Carrots	1 serving	Place the carrots in the microwave safe bowl. Add 1-4 tbs. of water (1 tbs. per serving). Cover with vented (1 inch vent) plastic wrap while cooking and stir before letting stand.
		2 servings	
		3 servings	
		4 servings	
	Corn	1 serving	Place the corn in the microwave safe bowl. Add 1-4 tbs. of water (1 tbs. per serving). Cover with vented (1 inch vent) plastic wrap while cooking and stir before letting stand.
		2 servings	
		3 servings	
		4 servings	
	Green beans	1 serving	Place the green beans in the microwave safe bowl. Add 1-4 tbs. of water (1 tbs. per serving). Cover with vented (1 inch vent) plastic wrap while cooking and stir before letting stand.
		2 servings	
		3 servings	
		4 servings	
Peas	1 serving	Place the peas in the microwave safe bowl. Add 1-4 tbs. of water (1 tbs. per serving). Cover with vented (1 inch vent) plastic wrap while cooking and stir before letting stand.	
	2 servings		
	3 servings		
	4 servings		

Category	Menu	Amount	Instructions
Meal	Oatmeal	1 pack	Follow the package directions for the recommended amount of water needed. Stir well before cooking and afterwards.
		2 packs	
	Quinoa	2 servings	Follow the package directions for the recommended amount of water needed. Stir well before cooking and afterwards.
		4 servings	
	Frozen dinner	12 oz (340 gram)	Remove the food from its wrapping and follow the instructions on the box for covering and letting stand.
		16 oz (454 gram)	
	Frozen breakfast	5 oz (142 gram)	Use for frozen sandwiches, breakfast entrees, pancakes, waffles, etc. Follow the package instructions for covering and standing.
		8 oz (227 gram)	
Brown rice	2 servings	Add 1 cup of cold water for 1 cup of rice. Use a large glass bowl. Cover with vented (1 inch vent) plastic wrap. Rice doubles in volume during cooking. After the cooking time is over, stir before standing time, and then salt or add herbs and butter.	
	4 servings		

## Using your microwave oven

Category	Menu	Amount	Instructions
Meal	Whole wheat macaroni	2 servings	Add 1 cup of cold water for 1 cup of rice. Use a large glass bowl. Cover with vented (1 inch vent) plastic wrap. Carefully remove from the microwave and drain the hot water.
		4 servings	
	Bacon, pre-cooked	2 slices	Layer 2 paper towels on a microwave safe plate and arrange the bacon on the towels. Do not overlap bacon. Cover with an additional paper towel. Remove the paper towel immediately after cooking.
		4 slices	
		6 slices	
Melt/ Soften	Melt butter	1 stick (¼ lb.)	Unwrap the butter and cut the butter into several pieces. Place the butter on a microwave safe dish and cover with wax paper. Stir well afterwards.
		2 sticks (½ lb.)	
	Soften butter	1 stick (¼ lb.)	Remove the butter from the packaging and place on a microwave safe dish.
		2 sticks (½ lb.)	
	Melt chocolate	1 cup	Place the chocolate chips in a microwave safe dish. When the microwave oven beeps, stir well, and then press <b>START</b> to continue. Unless stirred, the chocolate chips will keep their shape even when the heating time is over.
	Soften ice cream	1 pint	Remove the lid of the carton. Place the carton in the center of the microwave.
4 pints			

Category	Menu	Amount	Instructions
Melt/ Soften	Soften cream cheese	1 pack	Unwrap the cream cheese and place on a microwave safe dish.
	Soften frozen juice	1 pack	Do not place metal juice cans in the microwave. Remove the plastic lid and place in center of microwave. Stir well afterwards.
	Melt cheese	1 cup	Place the cheese in a microwave safe bowl and cover with wax paper. Stir well afterwards.
	Melt caramel	10 oz (280 gram)	Place the caramel in a large microwave safe dish. Stir well afterwards.
	Melt marshmallows	10 oz (280 gram)	Place the marshmallows in a large microwave safe dish. Stir well afterwards.
Poultry/ Fish	Chicken breasts	4 servings	Pierce the chicken breasts 3 times with a knife. Place the chicken breasts on the microwave safe dish and cover with plastic wrap. Place the dish on the center of the turntable.
	Salmon fillets	1 serving	Put the salmon fillets on the microwave safe dish and cover with plastic wrap. Place the dish on the center of the turntable.
		2 servings	
	White fish fillets	1 serving	Put the white fish fillets on the microwave safe dish and cover with plastic wrap. Place the dish on the center of the turntable.
		2 servings	
Fresh prawns	1 serving	Place the prawns in the microwave safe dish and cover with plastic wrap. Place the dish on the center of the turntable.	
	2 servings		



## Microwave

Your microwave oven allows you to set two different cooking stages, each with its own time length and power level. The power level lets you control the heating intensity from Warm (1) to High (10).

### Power levels

The 10 power levels allow you to choose the optimal power level for your cooking needs.

No.	Power Level	Description	No.	Power Level	Description
1	10	Warm	6	60	Simmer
2	20	Low	7	70	Medium high
3	30	Defrost	8	80	Reheat
4	40	Medium low	9	90	Sauté
5	50	Medium	10	100	High

## One-stage cooking

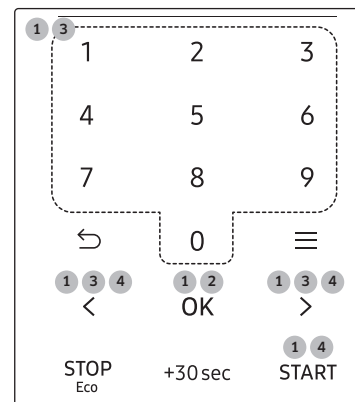

1. In standby mode, touch the **numeric** buttons to set a cooking time. You can enter a time from one second to 99 minutes and 99 seconds. If the display is showing cooking modes, touch **<** or **>** button until the display shows **Microwave** and then touch **OK** button. To select a time greater than one minute, enter the seconds too. (For example, to set a cooking time of 20 minutes, enter **2, 0, 0, 0**.) If you do not need to set the power level, just touch the **START** button. The microwave will automatically operate at the High power level.
2. If you want to set the power level to a level other than High, touch the **OK** button.
3. Touch the **<**, **>** or **numeric** buttons that correspond to the power level you want to use.
4. Touch the **START** button. If you want to add or reduce the cooking time, use the **<** or **>** button. You can adjust the cooking time while the microwave oven is operating.

## Multi-stage cooking (maximum of 2 stages)

Your oven allows you to set two different cooking stages, each with its own time length and power level. The power level lets you control the heating intensity from Warm to High.

1. Follow steps 1, 2, and 3 from the “One-stage cooking” section.
2. Touch **OK** button to move to the second stage.
3. Follow steps 1, 2, 3, and 4 from the “One-stage cooking” section.

# Cookware guide

To cook food in your microwave oven, microwaves must be able to penetrate the food without being reflected or absorbed by the cookware holding the food.

Consequently, it is important to choose cookware that both allows microwaves to penetrate food and is microwave-safe.

The following lists contain various types of cookware and indicate if and how the cookware should be used in a microwave oven.

## Recommended cooking utensils

- **Glass and glass-ceramic bowls and dishes** – Use for heating or cooking.
- **Microwavable plastic wrap** – Use to cover. Leave a small opening for steam to escape and avoid placing it directly on the food.
- **Wax paper** – Use as a cover to prevent spattering.
- **Paper towels and napkins** – Use for short-term heating and covering. They absorb excess moisture and prevent spattering. Do not use recycled paper towels, which may contain metal and can catch fire.
- **Paper plates and cups** – Use for short-term heating at low temperatures. Do not use recycled paper, which may contain metal and can catch fire.
- **Thermometers** – Use only those labeled “Microwave Safe” and follow all directions. Check the food in several places. Conventional thermometers may be used once the food has been removed from the oven.

## Limited use items

- **Aluminum foil** – Use narrow strips of foil to prevent overcooking of exposed areas. Using too much foil can damage your oven, so be careful.
- **Ceramic, porcelain, and stoneware** – Use these if they are labeled “Microwave Safe”. If they are not labeled, test them to make sure they can be used safely. Never use dishes with metallic trim.
- **Plastic** – Use only if labeled “Microwave Safe”. Other plastics can melt.
- **Straw, wicker, and wood** – Use only for short-term heating, as they are flammable.

## Not recommended

- **Glass jars and bottles** – Regular glass is too thin to be used in a microwave and can shatter.
- **Paper bags** – These are a fire hazard, except for popcorn bags that are designed for microwave use.
- **Styrofoam plates and cups** – These can melt and leave an unhealthy residue on food.
- **Plastic storage and food containers** – Containers such as margarine tubs can melt in the microwave.

## Testing utensils

If you are not sure whether a dish is microwave-safe or not, you can perform this test:

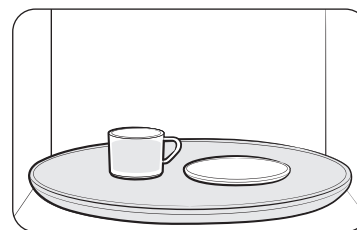

1. Fill a 1 cup glass measuring cup with water and put it inside your oven, next to the dish you want to test.
2. Set the microwave to 1 minute using the **numeric** buttons, and then touch the **START** button. This will heat the glass and dish for one minute at High power.

When the microwave stops, the water should be warm and the dish you are testing should be cool.

If the dish is warm, then it is absorbing microwave energy and is not acceptable for use in the microwave.

# Cooking guide

---

Microwave energy actually penetrates food and is attracted to and absorbed by the water, fat, and sugar molecules in the food. The microwaves cause the molecules in the food to move rapidly. The rapid movement of these molecules creates friction and the resulting heat cooks the food.

## Cooking techniques

---

### Stirring

Stir foods such as casseroles and vegetables while cooking to distribute heat evenly. Food at the outside of the dish absorbs more energy and heats more quickly, so stir from the outside to the center. The oven will turn off when you open the door to stir your food.

### Arrangement

Arrange unevenly shaped foods, such as chicken pieces or chops, with the thicker, meatier parts toward the outside of the turntable where they will receive more microwave energy. To prevent overcooking, place thin or delicate parts toward the center of the turntable.

### Shielding

Shield food with narrow strips of aluminum foil to prevent overcooking. Areas that need shielding include poultry wing-tips, the ends of poultry legs, and the corners of square baking dishes. Use only small amounts of aluminum foil. Larger amounts can damage your oven.

### Turning

Turn foods over midway through cooking to expose all parts to microwave energy. This is especially important with large items such as roasts.

### Standing

Food cooked in the microwave builds up internal heat and continues to cook for a few minutes after the oven stops. Let food stand to complete cooking, especially food such as roasts and whole vegetables. Roasts need this time to complete cooking in the center without overcooking the outer areas. All liquids, such as soup or hot chocolate, should be shaken or stirred when cooking is complete. Let liquids stand a moment before serving. When heating baby food, stir well and test the temperature before serving.

### Adding Moisture

Microwave energy is attracted to water molecules. Food that is uneven in moisture content should be covered or allowed to stand so that the heat disperses evenly. Add a small amount of water to dry food to help it cook.

### Venting

After covering a dish with plastic wrap, vent the plastic wrap by turning back one corner so excess steam can escape.

# Cooking guide

---

## General cooking recommendations

---

- Dense foods, such as potatoes, take longer to heat than lighter foods. Food with a delicate texture should be heated at a low power level to prevent it from becoming tough.
- Altitude and the type of cookware you are using can affect cooking time. When trying a new recipe, use the minimum cooking time and check the food occasionally to prevent overcooking.
- Food with a non-porous skin such as potatoes or hot dogs should be pierced to prevent bursting.
- Frying with oil or fat is not recommended. Fat and oil can suddenly boil over and cause severe burns.
- Some ingredients heat faster than others. For example, the jelly inside a jelly doughnut will be hotter than the dough. Keep this in mind to avoid burns.
- Home canning in the microwave oven is not recommended because all harmful bacteria may not be destroyed by the microwave heating process.
- Although microwaves do not heat the cookware, the heat from the food is often transferred to the cookware. Always use pot holders when removing food from the microwave and instruct children to do the same.
- Making candy in the microwave is not recommended as candy can heat to very high temperatures. Keep this in mind to avoid injury.

## Guide for cooking eggs in your microwave

---

- Never cook eggs in the shell and never warm hard-cooked eggs in the shell. They can explode.
- Always pierce whole eggs to keep them from bursting.
- Cook eggs just until set. They become tough if overcooked.

## Guide for cooking vegetables in your microwave

---

- Vegetables should be washed just before cooking. Often, no extra water is needed. If you are cooking dense vegetables such as cubed potatoes, carrots, or green beans, add about  $\frac{1}{4}$  cup water.
- Small vegetables (sliced carrots, peas, lima beans, etc.) will cook faster than larger ones.
- Whole vegetables, such as potatoes, acorn squash, or corn on the cob, should be arranged in a circle on the turntable before cooking. They will cook more evenly if turned over after half the cooking time.
- Always place vegetables like asparagus and broccoli with the stem ends pointing towards the edge of the dish and the tips toward the center.
- When cooking cut vegetables, always cover the dish with a lid or vented microwavable plastic wrap.
- Whole, unpeeled vegetables such as potatoes, squash, eggplant, etc., should have their skin pricked in several spots before cooking to prevent them from bursting.
- For more even cooking, stir or rearrange whole vegetables halfway through the cooking time.
- Generally, the denser the food, the longer the standing time. (Standing time refers to the time necessary for dense, large foods and vegetables to finish cooking after they come out of the oven.) A baked potato can stand on the counter for five minutes before cooking is completed, while a dish of peas can be served immediately.

# Cleaning and maintaining your microwave oven

---

Keeping your microwave oven clean improves its performance, wards off unnecessary repairs, and lengthens its life.

## Cleaning the exterior

---

It's best to clean spills on the outside of your microwave oven as they occur. Use a soft cloth and warm, soapy water. Rinse and dry.

### CAUTION

Do not get water into the vents. Never use abrasive products or chemical solvents such as ammonia or alcohol as they can damage the appearance of your microwave.

### WARNING

Unplug the microwave plug before cleaning.

## Cleaning under your microwave oven

---

Regularly clean grease and dust from the bottom of your microwave using a solution of warm water and detergent.

## Cleaning the control panel

---

Wipe with a damp cloth and dry thoroughly. Do not use cleaning sprays, large amounts of soap and water, abrasives, or sharp objects on the panel as it is easily damaged.

## Cleaning the door and door seals

---

Always ensure that the door seals are clean and that the door closes properly. Take particular care when cleaning the door seals to ensure that no particles accumulate and prevent the door from closing correctly. Wash the glass door with very mild soap and water. Be sure to use a soft cloth to avoid scratching.

### NOTE

If steam accumulates inside or outside the oven door, wipe with a soft cloth. Steam can accumulate when you operate the oven when humidity is high and in no way indicates microwave leakage.

## Cleaning the interior

---

### CAUTION

To avoid injury, ensure that the microwave oven has cooled down before cleaning it.

### CAUTION

Remove the glass tray from the oven when cleaning the oven or tray. To prevent the tray from breaking, handle it with care and do not put it in water immediately after cooking. Wash the tray carefully in warm sudsy water or in the dishwasher.

## Cleaning the turntable and roller rings

---

Clean the roller rings periodically and wash the turntable as required. The turntable can be washed safely in your dishwasher.

# Cleaning and maintaining your microwave oven

## Storing and repairing your microwave oven

If you need to store your microwave oven for a short or extended period of time, choose a dust-free, dry location. Dust and dampness may adversely affect the functionality of the microwave parts.

### **⚠ WARNING**

Do not repair, replace, or service any part of your microwave oven yourself. Allow only a qualified service technician to perform repairs. If the oven is faulty and needs servicing, or you are in doubt about its condition, unplug the oven from the power outlet and contact your nearest service center.

Do not use the oven if the microwave oven is damaged, in particular, if the door or door seals are damaged or the door does not close properly. This can be caused by a broken hinge, a worn out seal or distorted/bent casing.

Do not remove the oven from its casing.

This microwave oven is for home use only and is not intended for commercial use.

## Replacing the cooktop/night light

When replacing the cooktop/night light, make sure that you are wearing gloves to avoid injury from the heat of the lamp.

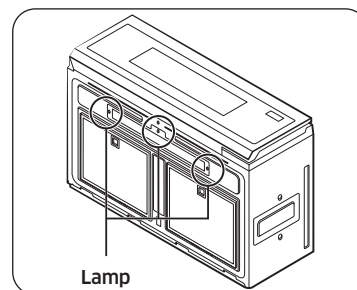

1. Unplug the oven or turn off the power at the main power supply.
2. Remove the screw from the light cover and lower the cover.
3. Disconnect the wire connectors.
4. Remove the screw securing the LED lamp board.
5. Replace the LED lamp board.

### **📖 NOTE**

To purchase a new LED lamp board, visit an authorized Samsung service center or call 1-800-SAMSUNG (726-7864).

---

## Replacing the oven light

---

When replacing the oven light, make sure that you are wearing gloves to avoid injury from the heat of the lamp.

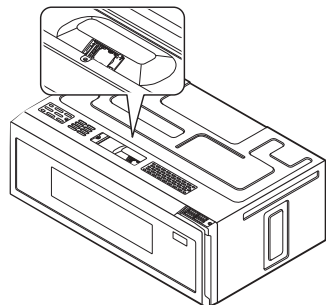

1. Unplug the oven or turn off the power at the main power supply.
2. Remove the vent cover mounting screw and then remove the vent cover.
3. Lift up the holder lamp by pushing the hook slightly.
4. Remove the lamp from the holder lamp and disconnect the wire connectors.
5. Replace the LED lamp.
6. Connect wire to LED lamp and place it on the holder lamp.
7. Insert holder lamp to the bracket, assemble vent cover and then mount the screw.
8. Plug the oven in or turn on the power at the main power supply. Reset the clock.

---

## Cleaning the grease filter

---

Your microwave oven has reusable grease filter. The grease filter should be removed and cleaned at least once a month or as required.

To order a new grease filter, contact Samsung Parts at 1-800-627-4368 or your Samsung dealer. You can also order online at [www.samsungparts.com](http://www.samsungparts.com).

### **⚠ WARNING**

To avoid the risk of personal injury or property damage, do not operate the oven hood without the filter in place.

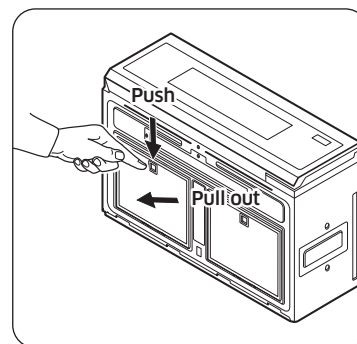

1. To remove the filter, push the handle of the grease filter.
2. Pull out the grease filter out of the microwave oven.
3. Soak the grease filter in hot water mixed with a mild detergent. Rinse well and shake to dry. If necessary, brush the filter lightly to remove embedded dirt.

# Cleaning and maintaining your microwave oven

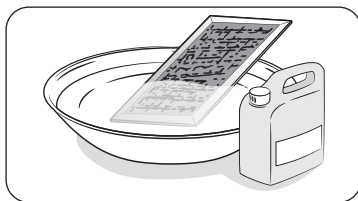

## ⚠ WARNING

Do not use ammonia or put the grease filter in the microwave oven to dry. The aluminum will darken.

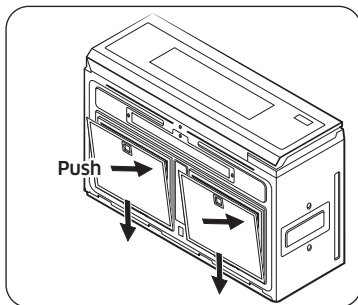

4. To re-insert the filter into the microwave oven, slide the filter into the frame slot, and then push it inside.

## Replacing the charcoal filter

The charcoal filter should be replaced every 6 to 12 months and more often if necessary. The charcoal filter cannot be cleaned. To order a new charcoal filter, contact the Samsung Parts at 1-800-627-4368 or your Samsung dealer. You can also order online at [www.samsungparts.com](http://www.samsungparts.com)

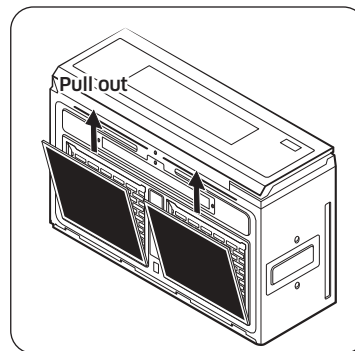
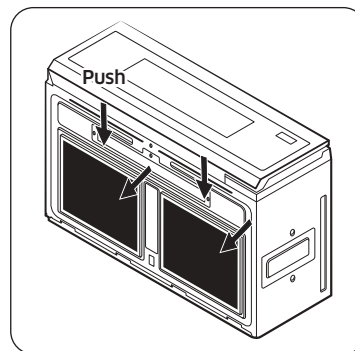

1. Unplug the oven or turn off the power at the main power supply.
2. Remove the grease filter. (Check the instructions on 'Cleaning the grease filter')
3. Push down the charcoal filter and then tilt it forward.
4. Pull the filter up to remove it.
5. Slide a new charcoal filter into place. Proceed opposite order from above instructions.
6. Insert grease filter. Plug the oven in or turn on the power at the main power supply. Reset the clock.



# Troubleshooting

## Check points

If you encounter a problem with your oven, first check the tables starting below and try the recommendations. If a problem persists, or if an information code keeps appearing on the display, contact a local Samsung service center.

Problem	Cause	Action
<b>General</b>		
The buttons cannot be touched properly.  <b>Tilt</b>	Foreign matter may be caught between the buttons.	Remove the foreign matter and try again.
	For touch models: Moisture is on the exterior.	Wipe the moisture from the exterior.
	The Child Lock is activated.	Deactivate the Child Lock.
The time is not displayed.	Power is not supplied.	Make sure power is supplied. Confirm the microwave is plugged in. Check your fuses or circuit breakers.
	The Eco (power-saving) function is set.	Turn off the Eco function.
The oven does not work.	Power is not supplied.	Make sure power is supplied. Confirm the microwave is plugged in. Check your fuses or circuit breakers.
	The door is open.	Close the door and try again.
	The door open safety mechanisms are covered by foreign matter.	Remove the foreign matter and try again.

Problem	Cause	Action
The oven stops while in operation.	The user has opened the door to turn food over.	After turning over the food, touch the <b>START</b> button again to start operation.
The power turns off during operation.	The oven has been cooking for an extended period of time.	After the oven has cooked for an extended period of time, let the oven cool.
	The cooling fan is not working.	Listen for the sound of the cooling fan.
	Trying to operate the oven without food inside.	Put food in the oven.
	There is not enough ventilation space around the oven.	There are intake/exhaust outlets on the front and rear of the oven for ventilation. Check the installation guide and make sure that the microwave is far enough away from walls and cabinets for proper ventilation.
There is no power to the oven.	Several appliances or devices are plugged into the same outlet.	Unplug all other appliances or devices from the outlet.
	Power is not supplied.	Make sure power is supplied. Confirm the microwave is plugged in. Check your fuses or circuit breakers.

# Troubleshooting

Problem	Cause	Action
There is a popping sound during operation, and the oven doesn't work.	Cooking food in a sealed container or using a container with a tight lid.	Do not cook food in sealed containers or in containers with tight lids. Expanding steam from the cooking food can cause the containers to burst or the lids to pop off.
The oven exterior gets too hot during operation.	There is not enough ventilation space around the oven.	There are intake/exhaust outlets on the front and rear of the oven for ventilation. Check the installation guide and make sure that the microwave is far enough away from walls and cabinets for proper ventilation.
	Objects are on top of the oven.	Remove all objects on the top of the oven.
The door cannot be opened properly.	Food residue is stuck between the door and oven interior.	Clean the oven and then open the door.

Problem	Cause	Action
The oven does not heat.	The oven may not work if too much food is being cooked or improper cookware is being used.	To test the oven, put one cup of water in a microwave-safe container, put the container in the oven, and then run the microwave for 1-2 minutes to check whether the water is heated. If the water is heated, reduce the amount of food and start the function again. Use a cooking container with a flat bottom.
Heating is weak or slow.	The oven may not work if too much food is being cooked or improper cookware is being used.	To test the oven, put one cup of water in a microwave-safe container, put the container in the oven, and then run the microwave for 1-2 minutes to check whether the water is heated. If the water is heated, reduce the amount of food and start the function again. Use a cooking container with a flat bottom.

Problem	Cause	Action
The warm function does not work.	The oven may not work if too much food is being warmed or improper cookware is being used.	To test the oven, put one cup of water in a microwave-safe container, put the container in the oven, and then run the microwave for 1-2 minutes to check whether the water is heated. If the water is heated, reduce the amount of food and start the function again. Use a cooking container with a flat bottom.
The thaw function does not work.	The oven may not work if too much food is being thawed or improper cookware is being used.	To test the oven, put one cup of water in a microwave-safe container, put the container in the oven, and then run the microwave for 1-2 minutes to check whether the water is heated. If the water is heated, reduce the amount of food and start the function again. Use a cooking container with a flat bottom.

Problem	Cause	Action
The interior light is dim or does not turn on.	The door has been left open for a long time.	The interior light may automatically turn off when the Eco function operates. Close and reopen the door or touch the <b>STOP</b> button.
	The interior light is covered by foreign matter.	Clean the inside of the oven and check again.
A beeping sound occurs during cooking.	If the Auto Cook function is being used, this beeping sound means it's time to turn over the food.	After turning over the food, touch the <b>START</b> button again to restart operation.
The oven is not level.	The oven is installed on an uneven surface.	Make sure the oven is installed on flat, stable surface.
There are sparks during cooking.	Metal containers are used during cooking or thawing.	Do not use metal containers.
When power is connected, the oven immediately starts to work.	The door is not properly closed.	Close the door and check again.
There is electricity coming from the oven.	The power source or power outlet is not properly grounded.	Make sure the power source and power outlet are properly grounded.

# Troubleshooting

Problem	Cause	Action
There is water dripping.	Water or steam may be generated by the cooking or defrosting process, depending on the food. This is not an oven malfunction.	Let the oven cool and then wipe with a dry dish towel.
There is steam coming through a crack in the door.	Water or steam may be generated by the cooking or defrosting process, depending on the food. This is not an oven malfunction.	Let the oven cool and then wipe with a dry dish towel.
There is water left in the oven.	Water or steam may be generated by the cooking or defrosting process, depending on the food. This is not an oven malfunction.	Let the oven cool and then wipe with a dry dish towel.
The brightness inside the oven varies.	Changes in brightness reflect changes in power output. Power output changes depending on the functions in use.	Power output changes during cooking are not malfunctions.
Cooking is finished, but the cooling fan is still running.	To ventilate the oven, the cooling fan continues to run for about 3 minutes after cooking is complete.	This is not an oven malfunction.
Touching the <b>START</b> button operates the oven.	This happens when the oven is not operating.	The microwave oven is designed to start operating when you touch the <b>START</b> button if it was not operating.

Problem	Cause	Action
<b>Turntable</b>		
While turning, the turntable comes out of place or stops turning.	There is no roller ring, or the roller ring is not properly in place.	Install the roller ring properly and then try again.
The turn table drags while turning.	The roller ring is not properly in place, there is too much food, or the container is too large and touches the inside of the microwave.	Install the roller ring properly. Adjust the amount of food. Do not use containers that are too large.
The turn table rattles while turning and is noisy.	Food residue is stuck to the bottom of the oven.	Remove any food residue stuck to the bottom of the oven.

# Appendix

## Information codes

If the microwave oven fails to operate, you may see an information code on the display. Check the table below for the code, and then follow the directions.

Code	Description	Action
C-10	The GAS sensor is open.	Unplug the power cord of the oven, and then contact a local Samsung service center.
	The GAS sensor is shorted.	
C-F0	The microwave has sensed an internal communications failure.	Unplug the power cord of the oven, and then contact a local Samsung service center.
C-F1	Only occurs when EEPROM Read or Write is not working.	Unplug the power cord of the oven, and contact a local SAMSUNG Customer Care Center.
C-F2	A touch button has malfunctioned.	Touch <b>STOP</b> , and then try the button again.
C-d0	Control buttons are touched over 10 seconds.	Clean the keys and check if there is water on the surface around key. If it appears again, turn off the microwave oven, let it sit for more than 30 seconds, and then try setting again. If this code re-appears, call your local SAMSUNG Customer Care Center.

## Specifications

Model	ME11A7710D*/AA ME11A7510D*/AA	ME11A7710D*/AC ME11A7510D*/AC
Oven Cavity	1.1 cu ft	
Controls	10 power level, including Defrost	
Timer	99 minutes, 99 seconds	
Power Source	120 VAC, 60 Hz	
Power Consumption	1650 Watt Microwave	1500 Watt Microwave
Microwave Power Output	1100 Watts	1000 Watts
Cook Top Light	LED lamp (3 EA)	
Oven Light	LED lamp	
Oven Cavity Dimensions (inches)	18 ½" (W) X 6 ⅞" (H) X 14 ⅞" (D)	
Outside Dimensions (inches)	29 ⅞" (W) X 10 ¾" (H) X 19 ⅞" (D)	
Shipping Dimensions (inches)	33 ¼" (W) X 15 ⅞" (H) X 22 ⅞" (D)	
Net/Shipping Weight	ME11A7710D*: 55.8 lbs. / 65.3 lbs. (25.3 kg / 29.6 kg) ME11A7510D*: 53.6 lbs. / 63.1 lbs. (24.3 kg / 28.6 kg)	

# Warranty (USA)

---

## Samsung over-the-range (otr) microwave oven

---

### LIMITED WARRANTY TO ORIGINAL PURCHASER WITH PROOF OF PURCHASE

This SAMSUNG brand product, as supplied and distributed by SAMSUNG ELECTRONICS AMERICA, INC. (SAMSUNG) and delivered new, in the original carton to the original consumer purchaser, is warranted by SAMSUNG against manufacturing defects in materials or workmanship for the limited warranty period, starting from the date of original purchase, of:

**One (1) Year Parts and Labor**

**Ten (10) Years Magnetron Part (Part Only)**

This limited warranty is valid only on products purchased and used in the United States that have been installed, operated, and maintained according to the instructions attached to or furnished with the product. To receive warranty service, the purchaser must contact SAMSUNG at the address or phone number provided below for problem determination and service procedures. Warranty service can only be performed by a SAMSUNG authorized service center. The original dated bill of sale must be presented upon request as proof of purchase to SAMSUNG or SAMSUNG's authorized service center to receive warranty service.

SAMSUNG will provide in-home service within the contiguous United States during the warranty period at no charge, subject to availability of SAMSUNG authorized servicers within the customer's geographic area. If in-home service is not available, SAMSUNG may elect, at its option, to provide transportation of the product to and from an authorized service center. If the product is located in an area where service by a SAMSUNG authorized servicer is not available, you may be responsible for a trip charge or required to bring the product to a SAMSUNG authorized service center for service.

To receive in-home service, product must be unobstructed and accessible to the service agent.

During the applicable warranty period, a product will be repaired, replaced, or the purchase price refunded, at the sole option of SAMSUNG. SAMSUNG may use new or reconditioned parts in repairing a product, or replace the product with a new or reconditioned product. Replacement parts and products are warranted for the remaining portion of the original product's warranty or ninety (90) days, whichever is longer. All replaced parts and products are the property of SAMSUNG and you must return them to SAMSUNG.

This limited warranty covers manufacturing defects in materials or workmanship encountered in normal household, noncommercial use of this product and shall not cover the following: damage that occurs in shipment, delivery, installation, and uses for which this product was not intended; damage caused by unauthorized modification or alteration of the product; product where the original factory serial numbers have been removed, defaced, changed in any way, or cannot be readily determined; cosmetic damage including scratches, dents, chips, and other damage to the product's finishes; damage caused by abuse, misuse, overheating due to overcooking, glass tray or turntable, pest infestations, accident, fire, floods, or other acts of nature or God; damage caused by use of equipment, utilities, services, parts, supplies, accessories, applications, installations, repairs, external wiring or connectors not supplied or authorized by SAMSUNG; damage caused by incorrect electrical line current, voltage, fluctuations and surges; damage caused by failure to operate and maintain the product according to instructions; in-home instruction on how to use your product; service to correct installation not in accordance with electrical or plumbing codes or correction of household electrical or plumbing (i.e., house wiring, fuses, or water inlet hoses); and reduced magnetron power output related to normal aging.

The cost of repair or replacement under these excluded circumstances shall be the customer's responsibility.

Visits by an authorized servicer to explain product functions, maintenance or installation are not covered by this limited warranty. Please contact SAMSUNG at the number below for assistance with any of these issues.

---

Samsung will charge a repair fee for replacing an accessory or repairing cosmetic damage if the damage to the unit and/or damage to or loss of the accessory was caused by the customer. Items this covers include:

- Dented, scratched, or broken door, handle, out-panel, or control panel
- Broken or lost tray, guide roller, coupler, filter, or wire rack

Parts that SAMSUNG has determined can be replaced by the user may be sent to the customer for installation. In SAMSUNG's discretion, an authorized servicer can be dispatched to perform such installation.

### **EXCLUSION OF IMPLIED WARRANTIES**

IMPLIED WARRANTIES, INCLUDING THE IMPLIED WARRANTIES OF MERCHANTABILITY OR FITNESS FOR A PARTICULAR PURPOSE, ARE LIMITED TO ONE YEAR OR THE SHORTEST PERIOD ALLOWED BY LAW. Some states do not allow limitations on how long an implied warranty lasts, so the above limitations or exclusions may not apply to you. This warranty gives you specific rights, and you may also have other rights, which vary from state to state.

---

### **LIMITATION OF REMEDIES**

YOUR SOLE AND EXCLUSIVE REMEDY IS PRODUCT REPAIR, PRODUCT REPLACEMENT, OR REFUND OF THE PURCHASE PRICE AT SAMSUNG'S OPTION, AS PROVIDED IN THIS LIMITED WARRANTY. SAMSUNG SHALL NOT BE LIABLE FOR SPECIAL, INCIDENTAL OR CONSEQUENTIAL DAMAGES, INCLUDING BUT NOT LIMITED TO TIME WAY FROM WORK, HOTELS AND/OR RESTAURANT MEALS, REMODELING EXPENSES, LOSS OF REVENUE OR PROFITS, FAILURE TO REALIZE SAVINGS OR OTHER BENEFITS REGARDLESS OF THE LEGAL THEORY ON WHICH THE CLAIM IS BASED, AND EVEN IF SAMSUNG HAS BEEN ADVISED OF THE POSSIBILITY OF SUCH DAMAGES. Some states do not allow exclusion or limitation of incidental or consequential damages, so the above limitations or exclusions may not apply to you. This warranty gives you specific rights, and you may also have other rights, which vary from state to state.

SAMSUNG does not warrant uninterrupted or error-free operation of the product. No warranty or guarantee given by any other person, firm, or corporation with respect to this product shall be binding on SAMSUNG.

To obtain warranty service, please contact SAMSUNG at:  
Samsung Electronics America, Inc.  
85 Challenger Road  
Ridgefield Park, NJ 07660

**1-800-SAMSUNG (726-7864) and [www.samsung.com/us/support](http://www.samsung.com/us/support)**

# Warranty (CANADA)

## Samsung over-the-range (otr) microwave oven

### Limited warranty to original purchaser

This SAMSUNG brand product, as supplied and distributed by Samsung Electronics Canada, Inc. (SAMSUNG) and delivered new, in the original carton to the original consumer purchaser, is warranted by SAMSUNG against manufacturing defects in materials and workmanship for a limited warranty period of:

### **ONE (1) YEAR PARTS AND LABOR, FIVE (5) YEARS PARTS WARRANTY FOR MAGNETRON**

Samsung will charge a repair fee for replacing an accessory or repairing a cosmetic defect if the damage to the unit and/or damage to or loss of the accessory was caused by the customer. Items this stipulation covers include:

- A Dented, Scratched, or Broken Door, Handle, Out-Panel, or Control Panel
- A Broken or missing Tray, Guide Roller, Coupler, Filter, or Wire Rack

User Replaceable Parts may be sent to the customer for unit repair. If necessary, a Service Engineer can be dispatched to perform service.

This limited warranty begins on the original date of purchase, and is valid only on products purchased and used in the United States. To receive warranty service, the purchaser must contact SAMSUNG for problem determination and service procedures. Warranty service can only be performed by a SAMSUNG authorized service center. The original dated bill of sale must be presented upon request as proof of purchase to SAMSUNG or SAMSUNG's authorized service center.

SAMSUNG will repair this product or replace it if cannot repair it, at our option and at no charge as stipulated herein, with new or reconditioned parts or products if found to be defective during the limited warranty period specified above. All replaced parts and products become the property of SAMSUNG and must be returned to SAMSUNG. Replacement parts and products assume the remaining original warranty, or ninety (90) days, whichever is longer.

In-home service will be provided during the warranty labor period subject to availability within the contiguous United States. In-home service is not available in all areas. To receive in-home service, the product must be unobstructed and accessible to service personnel. If during in-home service repair can not be completed, it may be necessary to remove, repair and return the product. If in-home service is unavailable, SAMSUNG may elect, at our option, to provide for transportation of our choice to and from a SAMSUNG authorized service center. Otherwise, transportation to and from the SAMSUNG authorized service center is the responsibility of the purchaser.

This limited warranty covers manufacturing defects in materials and workmanship encountered in normal, noncommercial use of this product and shall not apply to the following, including, but not limited to: damage which occurs in shipment; delivery and installation; applications and uses for which this product was not intended; altered product or serial numbers; cosmetic damage or exterior finish; accidents, abuse, neglect, fire, water, lightning or other acts of nature; use of products, equipment, systems, utilities, services, parts, supplies, accessories, applications, installations, repairs, external wiring or connectors not supplied or authorized by SAMSUNG which damage this product or result in service problems; incorrect electrical line voltage, fluctuations and surges; customer adjustments and failure to follow operating instructions, cleaning, maintenance and environmental instructions that are covered and prescribed in the instruction book; problems caused by pest infestations, and overheating or overcooking by user; glass tray or turntable; reduced magnetron power output related to normal aging. SAMSUNG does not warrant uninterrupted or error-free operation of the product.



## Memo

---

THERE ARE NO EXPRESS WARRANTIES OTHER THAN THOSE LISTED AND DESCRIBED ABOVE, AND NO WARRANTIES WHETHER EXPRESS OR IMPLIED, INCLUDING, BUT NOT LIMITED TO, ANY IMPLIED WARRANTIES OF MERCHANTABILITY OR FITNESS FOR A PARTICULAR PURPOSE, SHALL APPLY AFTER THE EXPRESS WARRANTY PERIODS STATED ABOVE, AND NO OTHER EXPRESS WARRANTY OR GUARANTY GIVEN BY ANY PERSON, FIRM OR CORPORATION WITH RESPECT TO THIS PRODUCT SHALL BE BINDING ON SAMSUNG. SAMSUNG SHALL NOT BE LIABLE FOR LOSS OF REVENUE OR PROFITS, FAILURE TO REALIZE SAVINGS OR OTHER BENEFITS, OR ANY OTHER SPECIAL, INCIDENTAL OR CONSEQUENTIAL DAMAGES CAUSED BY THE USE, MISUSE OR INABILITY TO USE THIS PRODUCT, REGARDLESS OF THE LEGAL THEORY ON WHICH THE CLAIM IS BASED, AND EVEN IF SAMSUNG HAS BEEN ADVISED OF THE POSSIBILITY OF SUCH DAMAGES. NOR SHALL RECOVERY OF ANY KIND AGAINST SAMSUNG BE GREATER IN AMOUNT THAN THE PURCHASE PRICE OF THE PRODUCT SOLD BY SAMSUNG AND CAUSING THE ALLEGED DAMAGE. WITHOUT LIMITING THE FOREGOING, PURCHASER ASSUMES ALL RISK AND LIABILITY FOR LOSS, DAMAGE OR INJURY TO PURCHASER AND PURCHASER'S PROPERTY AND TO OTHERS AND THEIR PROPERTY ARISING OUT OF THE USE, MISUSE OR INABILITY TO USE THIS PRODUCT SOLD BY SAMSUNG NOT CAUSED DIRECTLY BY THE NEGLIGENCE OF SAMSUNG. THIS LIMITED WARRANTY SHALL NOT EXTEND TO ANYONE OTHER THAN THE ORIGINAL PURCHASER OF THIS PRODUCT, IS NONTRANSFERABLE AND STATES YOUR EXCLUSIVE REMEDY.

Some states do not allow limitations on how long an implied warranty lasts, or the exclusion or limitation of incidental or consequential damages, so the above limitations or exclusions may not apply to you. This warranty gives you specific legal rights, and you may also have other rights which vary from state to state.

To obtain warranty service, please contact SAMSUNG at:

**1-800-SAMSUNG (726-7864) or [www.samsung.com/ca/support](http://www.samsung.com/ca/support) (English)**

**[www.samsung.com/ca\\_fr/support](http://www.samsung.com/ca_fr/support) (French)**



Scan this with your smartphone

Scan the QR code\* or visit [www.samsung.com/spsn](http://www.samsung.com/spsn) to view our helpful How-to Videos and Live Shows

\* Requires reader to be installed on your smartphone

Please be advised that the Samsung warranty does NOT cover service calls to explain product operation, correct improper installation, or perform normal cleaning or maintenance.

## QUESTIONS OR COMMENTS?

COUNTRY	CALL	OR VISIT US ONLINE AT
U.S.A Consumer Electronics	1-800-SAMSUNG (726-7864)	<a href="http://www.samsung.com/us/support">www.samsung.com/us/support</a>
CANADA	1-800-SAMSUNG (726-7864)	<a href="http://www.samsung.com/ca/support">www.samsung.com/ca/support</a> (English) <a href="http://www.samsung.com/ca_fr/support">www.samsung.com/ca_fr/support</a> (French)

