

Dishwasher

User manual

DW80CG545*, DW80CG542*, DW80CG502*, DW80CB545*



SAMSUNG

Contents

Safety information	4
What you need to know about the safety instructions	4
Important safety symbols	4
Before using your dishwasher	7
Regulatory notice	8
Before you start	10
Unpacking your dishwasher	10
Checking parts	11
Unsuitable items for the dishwasher	13
Using your dishwasher	14
Basic use of racks	14
Detergent guidelines	24
Touchpad responsiveness	27
Operations	28
Control panel	28
Cycle overview	31
Simple steps to start your dishwasher	33
Settings	34
SmartThings	36
Special features	39
Maintenance	40
Cleaning	40
Long-term care	45
Cleaning the drain pump	45
Storing your dishwasher	46

Troubleshooting	47
Check these solutions if your dishwasher...	47
Information codes	52
Cycle chart	54
Appendix	58
Helping the environment	58
Specifications	58
Open Source Announcement	59
Warranty (U.S.A)	60

Safety information

Congratulations on your new Samsung dishwasher. This manual contains important information on the installation, use, and care of your appliance. Please take time to read this manual to take full advantage of your dishwasher's many benefits and features.

What you need to know about the safety instructions

Warnings and Important Safety Instructions in this manual do not cover all possible conditions and situations that may occur. It is your responsibility to use common sense, caution, and care when installing, maintaining, and operating your dishwasher.

Important safety symbols

What the icons and signs in this user manual mean:

WARNING

Hazards or unsafe practices that may result in **severe personal injury or death**.

To reduce the risk of fire, explosion, electric shock, or personal injury when using your dishwasher, follow these basic safety precautions:

CAUTION

Hazards or unsafe practices that may result in **minor personal injury or property damage**.

NOTE

These warning signs are here to prevent injury to you and others.

Please follow them explicitly.

After reading this section, keep it in a safe place for future reference.

SAVE THESE INSTRUCTIONS

California Proposition 65 Warning

 **WARNING:** Cancer and Reproductive Harm -
www.P65Warnings.ca.gov.

WARNING

When using your dishwasher, follow basic precautions, including the following:

1. Read all instructions before using the dishwasher.
2. Use the dishwasher only for its intended function.
3. Use only detergents or wetting agents recommended for use in a dishwasher and keep them out of the reach of children.
4. When loading items to be washed:
 - locate sharp items so that they are not likely to damage the door seal, and
 - load sharp knives with the handles up to reduce the risk of cut-type injuries.
5. Do not wash plastic items unless they are marked "dishwasher safe" or the equivalent. For plastic items not so marked, check the manufacturer's recommendations.
6. Do not touch the HEATING ELEMENT during or immediately after use.
7. Do not operate your dishwasher unless all ENCLOSURE panels are properly in place.
8. Do not tamper with the controls.
9. Do not abuse, sit on, or stand on the door or dish rack of the dishwasher.
10. To reduce the risk of injury, do not allow children to play in or on the dishwasher.
11. Under certain conditions, hydrogen gas may be produced in a hot-water system that has not been used for two weeks or more. HYDROGEN GAS IS EXPLOSIVE. If the hot-water system has not been used for such a period, before using the dishwasher turn on all hot-water faucets and let the water flow from each for several minutes. This will release any accumulated hydrogen gas. As the gas is flammable, do not smoke or use an open flame during this time.
12. Remove the door to the washing compartment when removing an old dishwasher from service or discarding it.

SAVE THESE INSTRUCTIONS



Safety information

CAUTION

- After unpacking the dishwasher, keep the packaging out of the reach of children.
- The dishwasher is extremely heavy. Do not attempt to move or carry the dishwasher by yourself. Two or more people are needed to move a dishwasher and avoid potential injuries.
- As with any equipment using electricity, water, and moving parts, potential hazards exist.
- Do not install the dishwasher near electrical components. Keep the dishwasher away from open flames.
- Install and level your dishwasher on an uncarpeted floor that can support its weight.
- Your dishwasher must be properly grounded. Never connect it to an ungrounded outlet. See page 7 for more information on grounding your dishwasher.
- Connect the ground wire to the green ground connector in the terminal box.
- After the dishwasher is installed, check that the drain hose is properly connected and that there is no leakage from the hose connectors. If the drain hose is loose, it may cause property damage.
- The water supply line is susceptible to breakage. As time goes by, it becomes less flexible. Check the line periodically. If it is swollen, torn, cut, or there is a water leak, replace it immediately.
- To safely operate this appliance, familiarize yourself with its operations and exercise care when using it.
- Do not put gasoline, solvents, or other flammable materials inside the dishwasher. Do not wash dishes exposed to these materials.
- Keep your dishwasher detergent out of the reach of children. Detergent has an adverse effect on human organs. It contains elements for polishing and is corrosive. Avoid letting the detergent come into contact with your skin and eyes.
- Do not push or place pressure on the door when it is open, as this may damage the dishwasher or cause harm.
- Do not allow children to play in or on the dishwasher. They may harm themselves or damage the dishwasher.
- Disconnect the power cable (or set the circuit breaker to off) before servicing your dishwasher.
- Do not repair, replace, or service any part of your dishwasher yourself. Disassembly, repairs, and modifications are permitted by authorized service technicians only. Work done by an unauthorized person may void your warranty.

SAVE THESE INSTRUCTIONS



- Before disposing of your dishwasher, remove the door of the washing compartment or the door latch so that children or small animals cannot get trapped inside.
- If the dishwasher is left unused for an extended period of time, turn off the water supply.
- This dishwasher is intended for residential use only.

Before using your dishwasher

WARNING



Tip-Over Hazard

- Do not use the dishwasher until it is correctly installed.
- Do not push down on the dishwasher door when it is open.
- Do not place excessive weight on the dishwasher door when it is open.



Electric Shock Hazard

Failure to follow these instructions can result in death, fire, or electric shock:

- Electrically ground the dishwasher
- Connect the ground wire to the green ground connector in the junction box.
- Do not use an extension cord.

SAVE THESE INSTRUCTIONS

Safety information

Regulatory notice

FCC Notice

FCC CAUTION:

Any changes or modifications not expressly approved by the party responsible for compliance could void the user's authority to operate the equipment.

This device complies with Part 15 of FCC Rules. Operation is Subject to following two conditions:

- (1) This device may not cause harmful interference, and
- (2) This device must accept any interference received including interference that cause undesired operation.

For products sold in the US and Canadian markets, only channels 1-11 are available. You cannot select any other channels.

FCC STATEMENT:

This equipment has been tested and found to comply within the limits for a Class B digital device, pursuant to part 15 of the FCC Rules. These limits are designed to provide reasonable protection against harmful interference in a residential installation.

This equipment generates, uses, and can radiate radio frequency energy and, if not installed and used in accordance with the instructions, may cause harmful interference to radio communications. However, there is no guarantee that interference will not occur in a particular installation. If this equipment does cause harmful interference to radio or television reception, which can be determined by turning the equipment off and on, the user is encouraged to try to correct the interference by one or more of the following measures:

- Reorienting or relocating the receiving antenna
- Increasing the separation between the equipment and receiver
- Connecting the equipment to an outlet that is on a different circuit than the radio or TV.
- Consulting the dealer or an experienced radio/TV technician for help.

SAVE THESE INSTRUCTIONS



FCC RADIATION EXPOSURE STATEMENT:

This equipment complies with FCC radiation exposure limits set forth for an uncontrolled environment. This equipment should be installed and operated so there is at least 8 inches (20 cm) between the radiator and your body. This device and its antenna(s) must not be co-located or operated in conjunction with any other antenna or transmitter.

IC Notice

The term “IC” before the radio certification number only signifies that Industry Canada technical specifications were met. Operation is subject to the following two conditions: (1) this device may not cause interference, and (2) this device must accept any interference, including interference that may cause undesired operation of the device.

This Class B digital apparatus complies with Canadian ICES-003.

Cet appareil numérique de la classe B est conforme à la norme NMB-003 du Canada.

For products sold in the US and Canadian markets, only channels 1–11 are available. You cannot select any other channels.

IC RADIATION EXPOSURE STATEMENT:

This equipment complies with IC RSS-102 radiation exposure limits set forth for an uncontrolled environment. This equipment should be installed and operated so there is at least 8 inches (20 cm) between the radiator and your body. This device and its antenna(s) must not be co-located or operated in conjunction with any other antenna or transmitter.

SAVE THESE INSTRUCTIONS





Before you start

Be sure to have your installer follow these instructions closely so that your new dishwasher works properly and that you're not at risk of injury when washing dishes.

Unpacking your dishwasher

- Once your new dishwasher has been delivered to you, carefully unpack it and check for any damage.
If the dishwasher has been damaged, make note of it on the waybill and keep a copy. Do not install the dishwasher, and contact Samsung Customer Service at the number listed on the next page.
- If there is no damage to the product, you can proceed with the installation. If you are going to install it yourself, make sure to read through the installation guide and follow the directions inside.
- After unpacking your dishwasher, keep the packaging out of the reach of children to ensure their safety.



Checking parts

When your dishwasher has been unpacked, make sure you've received all the parts shown below.

If your dishwasher was damaged during shipping, or if you do not have all the parts, contact **Samsung Customer Service** at **1-800-SAMSUNG (726-7864)**.

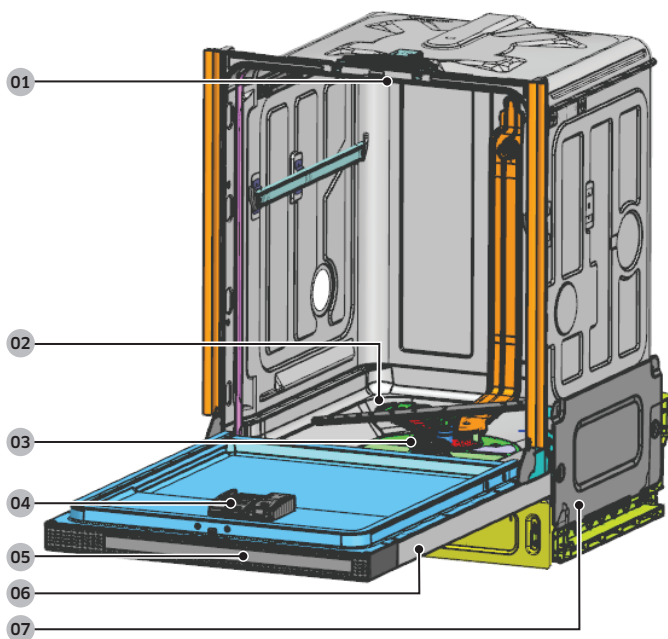

01 Top nozzle

02 Storm Wash*

03 Lower nozzle

04 Dispenser

05 Control panel

06 Door

07 Base

* Storm Wash* : DW80CG545*, DW80CG542*, DW80CB542*

Before you start

Before you start

Accessories

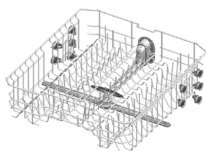

Upper rack
(DW80CG542*,
DW80CG502* Models)

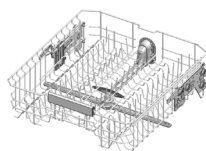

Upper rack
(DW80CG545*,
DW80CB545* Models)



Lower rack



Cutlery rack

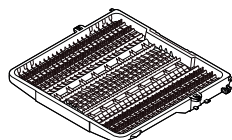

3rd rack
(DW80CG545*,
DW80CB545* Models)

Before you start

NOTE

Accessory parts - User/Installation manual, Installation Kit, Kick Plate.

CAUTION

- Do not wash items that are covered with ash, sand, wax, lubricating grease, or paint. These materials will damage the dishwasher. Ash does not dissolve and will spread inside the dishwasher.
- Remove food remains such as bones, fruit seeds, etc. and waste such as toothpicks, paper napkins, etc. from your dishes. Food remains and waste can make noise, cause the dishwasher to malfunction, and damage your dishes and dishwasher.

Unsuitable items for the dishwasher

WARNING

Wash only items such as glass, porcelain, and cutlery which the manufacturer states is dishwasher safe. Do not wash aluminium (e.g. grease filters). The dishwasher may damage aluminium, or in extreme cases, cause a severe chemical reaction.

Do not wash the following items in the dishwasher.

- Copper, brass, tin, ivory, and aluminium items or items with adhesive
- Non-heat resistant plastics
- Craft items, antiques, valuable vases, and decorative glassware
- Pottery or glazed-ceramic items
- Wooden cutlery and crockery or items with wooden parts
- Delicate glassware or glassware containing lead crystal. Clouding may occur on the glassware after frequent washing.

NOTE

Silverware that has contacted food containing sulphur may become discoloured. Food with sulphuric content include egg yolks, onions, mayonnaise, mustard, fish, fish brine, and marinades.

Using your dishwasher

Basic use of racks

Height adjustment

You can adjust the height of the upper rack in your Samsung dishwasher so that the lower rack can accommodate larger sized dishes. Depending on where you set the upper rack height, the lower rack can accommodate plates up to 12 in. (30 cm) in diameter and the upper rack can accommodate plates up to 8 in. (20 cm) in diameter.

DW80CG545*, DW80CB545* Models

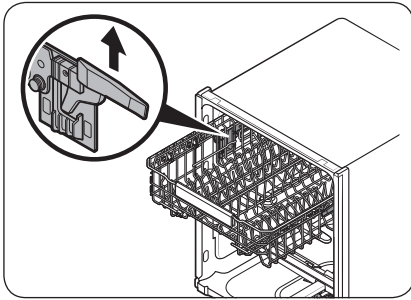

To raise the upper rack

Pull the upper rack upwards. The adjustable handle will latch, and the upper rack will rise.

To lower the upper rack

Hold both the adjustable handles located at the left and right sides of the upper rack, and then evenly press down.

⚠ CAUTION

- Adjust the height of the upper rack before loading dishes into the rack. Adjusting the rack after loading the dishes may damage the dishes.
- Make sure to hold both handles when adjusting, or the dishwasher door may not close properly.

DW80CG542*, DW80CG502* Models

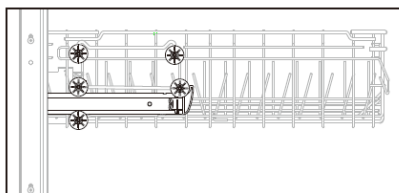

Upper position

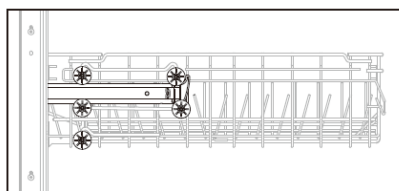

Lower position

To raise the upper rack

Pull the upper rack out, and then put the lower three wheels located at the left and right sides of the upper rack to lock on the rail.

To lower the upper rack

Pull the upper rack out, and then put the upper four wheels to lock on the rail.

⚠ CAUTION

Adjust the height of the upper rack before loading dishes into the rack. Adjusting the rack after loading the dishes may damage the dishes.

Using your dishwasher

To remove the upper rack

Pull the upper rack towards the front and then remove it by lifting it up slightly and pulling it towards the front. See the illustrations below.

⚠ CAUTION

While the upper rack is removable, it must be installed for the dishwasher to operate properly.

If you attempt to operate the dishwasher without the rack, noise will occur and the dishwasher will perform poorly.

DW80CG545*, DW80CB545* Models

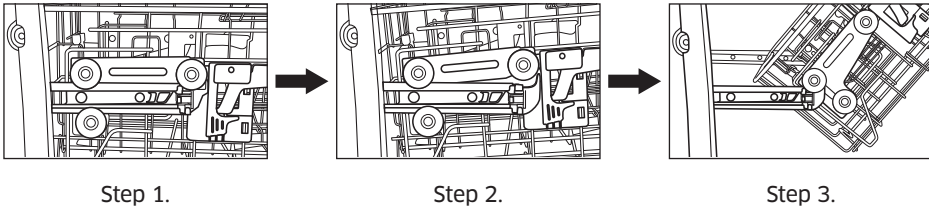

DW80CG542*, DW80CG502* Models

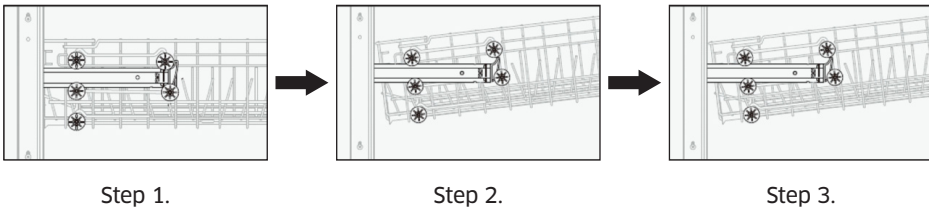

To remove the 3rd Rack

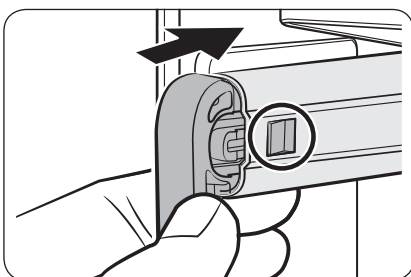
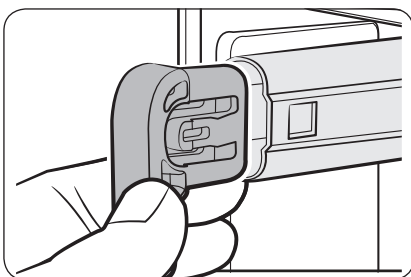
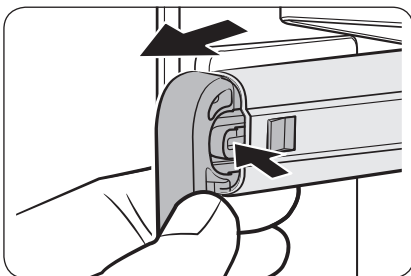

1. Stand facing the dishwasher, and then pull the 3rd rack out so that the handles at the ends of the rack supports (dark grey in the illustration) are even with the end of the rack.
2. With your right thumb, find the small indentation on the inside of the left rack support that houses the tab for the handle lock.
3. Push the handle lock tab in (i.e. to your left) with the tip of your thumb, and then pull the handle towards you until it disengages from the support.
4. Repeat this process with the right handle using your left thumb.
5. When the handles are removed, remove the 3rd rack from the dishwasher.

6. Reverse the order of removal to re-insert the 3rd rack.

⚠ CAUTION

Make sure the hook-shaped part of the handle faces downward and the handle lock (circled) re-engages when reinserting the handle into the rail.

Using your dishwasher

Loading dishes

Loading the lower rack

The lower rack has been especially designed for dinner dishes, soup bowls, plates, pots, lids, casserole dishes, and plates.

Load large items such as pans and pots into the dishwasher so their open sides face downwards. We recommend loading cups, stemware, and small plates into the upper rack. See the recommended loading patterns below.



8 place settings

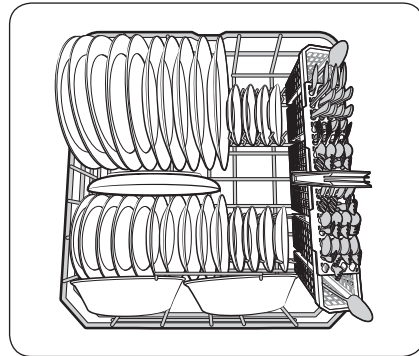

10 place settings

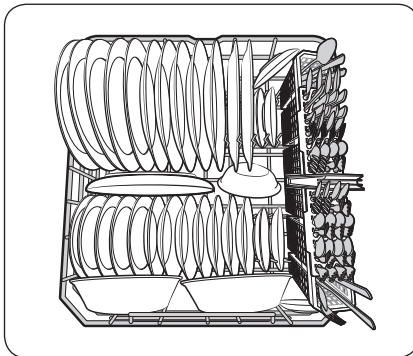

12 place settings

Loading the Storm Wash⁺ Area

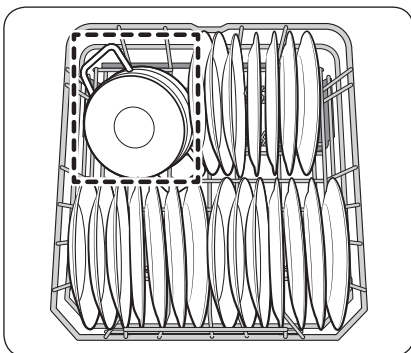

For more effective cleaning, load large items into the Storm Wash⁺ area on the left side of the lower rack (Dotted zone).

When you select Storm Wash⁺, the dishwasher supplies additional power to reinforce the water jet in the Storm Wash⁺ area.

Make sure pot handles and other items do not interfere with the rotation of the nozzles.

Using your dishwasher

Loading the upper rack

The upper rack has been designed for small plates, mugs, glasses, and plastic items marked "dishwasher safe". Load your plates into the dishwasher in two half rows, so that the front of each plate faces the back of the plate in front of it, and the open sides of the plates at the center of the dishwasher face each other. See the illustrations below.

Make sure the loaded dishes do not interfere with the rotation of the nozzle which is located at the bottom of the upper rack. (Check this by rotating the nozzle by hand.)

When loading dishes, pull the upper rack out sufficiently so you can load it without striking the counter above.



8 place settings

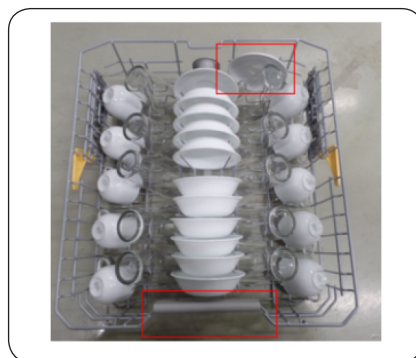

10 place settings



12 place settings

Loading the 3rd Rack™

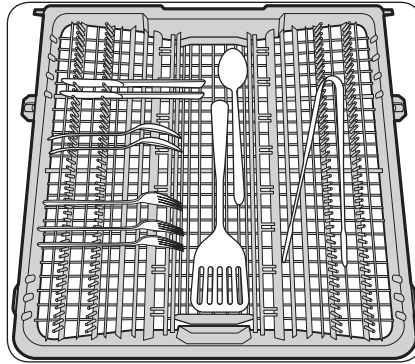

The 3rd rack is best suited for flatware and cooking or serving utensils. Use it with the spoon stands in the lower basket. You can load cutlery and utensils in the 3rd rack or the spoon stands in the lower basket.

Removing the 3rd Rack

The entire 3rd rack can be removed if more space is needed on the upper rack for larger items. (See the "To remove the 3rd Rack" section on page 17.)



Using your dishwasher

Loading the Cutlery rack

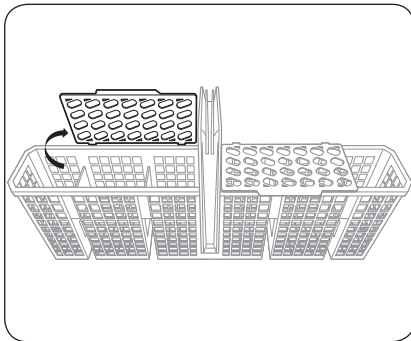

The cutlery rack consists of two compartments.

You can place each knife, spoon, or fork separately into the spoon stands in the basket's covers to prevent chipping and discoloration. See the illustrations below.

You can use the cutlery rack with the cover open. Refer to the illustration on the left.

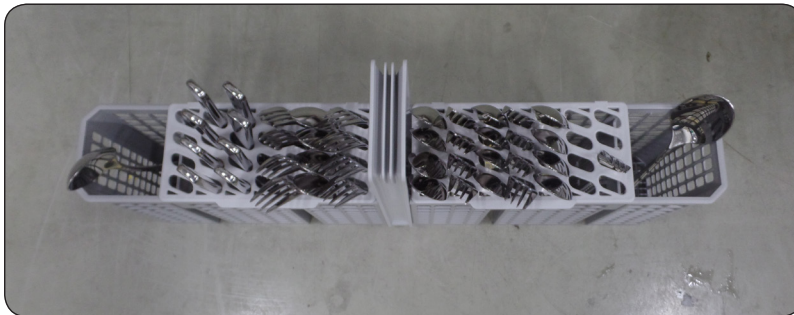

8 place settings

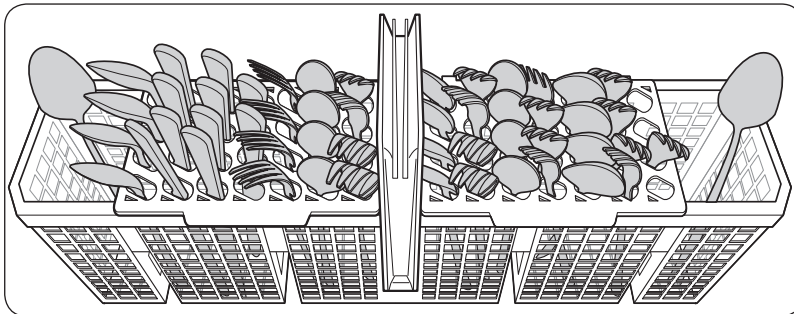

10 place settings



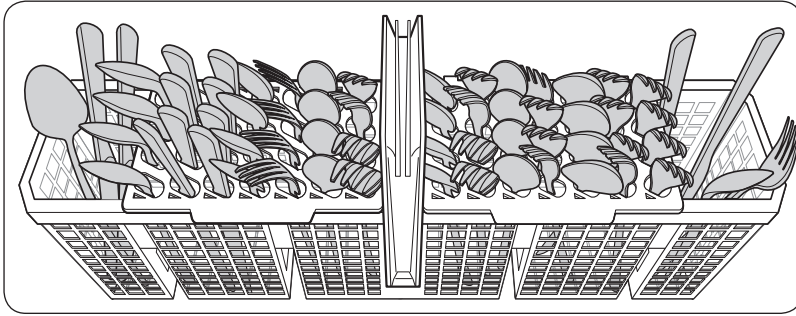

12 place settings

The spoon stands as seen from above with the suggested placement of cutlery items. Match the numbers in the diagram to the numbers in the list of cutlery items below.

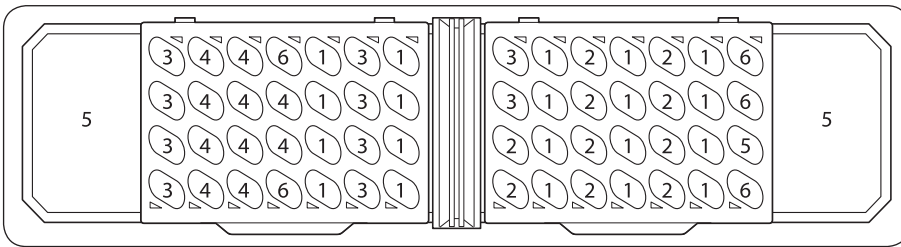

NOTE

Do NOT let any item extend through the bottom. Do not load chopsticks in this rack, which should be loaded in the 3rd rack.

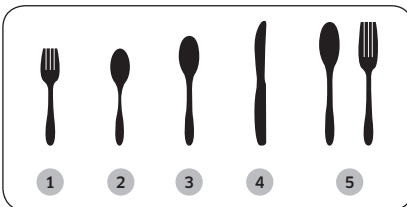

1. Forks
2. Tea spoons
3. Dinner spoons
4. Knives
5. Serving spoons and Serving forks
6. Remaining items

Using your dishwasher

Detergent guidelines

All dishwasher cycles require detergent in the detergent compartment. Apply detergent as appropriate for the selected cycle to ensure best performance.

⚠ WARNING

- Do not consume dishwasher detergent. Avoid breathing in detergent fumes. Dishwasher detergent contains irritants and caustic chemicals that can induce respiratory conditions. If you have consumed dishwasher detergent or inhaled detergent fumes, seek medical attention immediately.
- Keep dishwasher detergent out of children's reach.

⚠ CAUTION

Use dishwasher detergent only. Other types of detergent produce excessive foam, which may decrease the dishwasher's performance or cause it to malfunction.

To fill the detergent dispenser

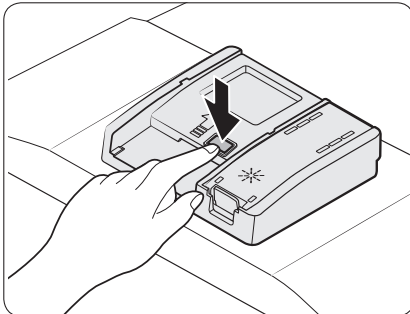

1. Open the detergent dispenser cap by pressing the detergent dispenser catch.

📖 NOTE

The cap remains open at the end of a cycle.

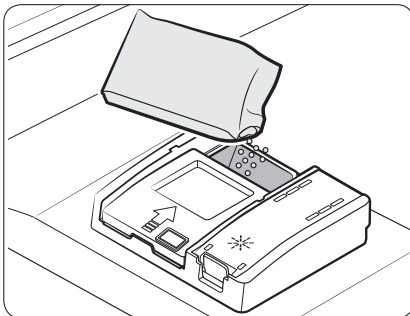

2. Add the recommended amount of detergent to the main wash detergent compartment.

📖 NOTE

There is no separate button that is specific to using tablet detergents.

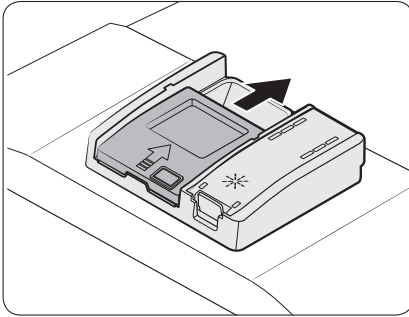

3. Close the lid by sliding it up.

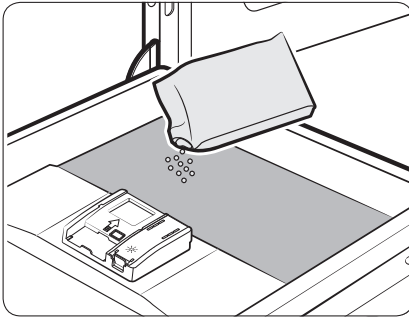

4. If the items are heavily soiled, pour a small amount of detergent onto the door for better cleaning results.

NOTE

The additional detergent will activate during the pre-wash process.

The cover opens automatically to dispense the detergent during the wash.

Using your dishwasher

Rinse aid

Rinse aid improves the drying performance of the dishwasher. When the Rinse Refill indicator lights up on the control panel, refill with rinse aid. Only use liquid rinse aid. Powdered rinse aid will clog the compartment opening and cause the dishwasher to malfunction.

⚠ CAUTION

- Do not apply any type of detergent to the rinse aid compartment.
- Do not over fill the compartment. Excessive rinse aid may overflow during a cycle.

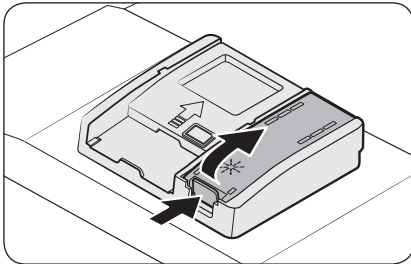

1. Open the rinse aid reservoir cap.

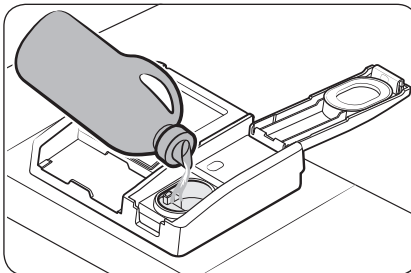

2. Fill the rinse aid reservoir with rinse aid.

⚠ CAUTION

Do not fill the reservoir above the full level indicator. Excess rinse aid can overflow during the wash cycle.

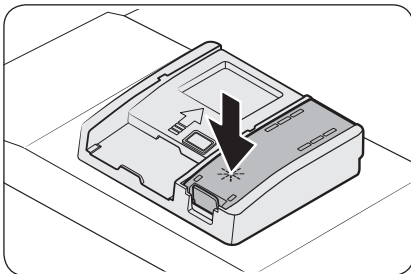

3. Close the rinse aid reservoir cap.

Touchpad responsiveness

To prevent the touch-enabled controls from losing responsiveness, follow these instructions.

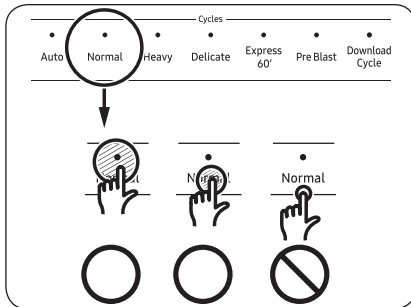

- Touch the center of each button with one finger.
- Do not touch more than one button at a time, except as directed.
- Clean the surface of the control panel regularly with a soft, damp cloth.

Operations

WARNING

To reduce the risk of fire, electric shock, or injury to persons, read the IMPORTANT SAFETY INSTRUCTIONS before operating this appliance.

Control panel

DW80CG545*, DW80CG542*, DW80CB545* Series

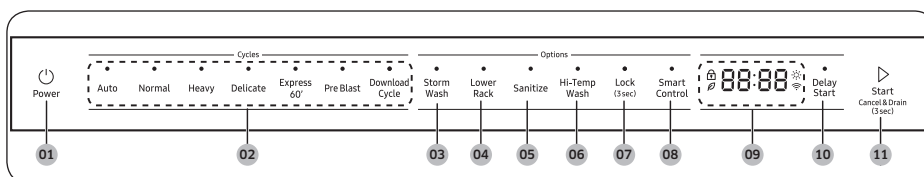

DW80CG502* Series

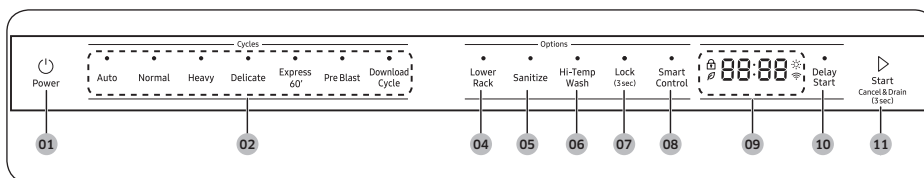

01 Power	When you press the Power button, the Cycle On light for the most recently started cycle turns on. When the selected cycle is complete, the dishwasher powers off automatically.
02 Cycle Selector	Select the appropriate wash cycle depending on the soil level of your dishes. After you select a cycle, the Cycle On light for that cycle lights. If you want to change the cycle once it has started, press the Power button. Then, turn on the dishwasher again and select a new cycle.
03 Storm Wash*	Use this option when you want to wash pots and pans, durable serving bowls, and other large, very dirty, hard to clean dishes. To use Storm Wash*, place the dishes face down in the storm wash nozzle up area in the lower basket.





04 Lower Rack	If selected, only the lower rack nozzle is activated to reduce both the cycle time and power consumption. Use this cycle to wash a small load of dishes or glasses in the lower rack. To wash heavily soiled items, select the Storm Wash* option.
05 Sanitize	<p>With the Sanitize option selected, the water temperature is increased to 167 °F (75 °C) in the final rinse cycle for high temperature sanitization.</p> <p>If you select the Sanitize option, the "Sanitize" lamp blinks when the water temperature reaches the sanitary temperature (over 155 °F (68 °C)), and then remains illuminated until the Sanitize option ends.</p> <p>When you open the door or press the Power button, the "Sanitize" lamp turns off.</p> <p> NOTE</p> <p>Only Normal cycle with the Sanitize option has been designed to meet the requirements for soil removal and sanitization efficacy in NSF 184. Certified residential dishwashers are not intended for licensed food establishments.</p> <p>For the Sanitize mode, the amount of detergent as 3/4 oz (20 g) in Main wash dispenser and 1/3 oz (10 g) on the door for pre-wash is used.</p>
06 Hi-Temp Wash	Raises the main wash temperature to improve cleaning for loads containing tough, baked-on food.
07 Lock (3 sec)	<p>Control Lock allows you to lock the buttons on the control panel so children cannot accidentally start the dishwasher by pressing the buttons on the panel.</p> <p>To lock and unlock the buttons on the control panel, hold the Lock (3 sec) button down for three (3) seconds when the power is On.</p>
08 Smart Control	You can monitor and control the dishwasher remotely through a Wi-Fi connection. To connect the dishwasher to your smart phone for the first time, press and hold Smart Control . For more information, see the " SmartThings " section on page 36.
09 Display	<p>Displays information about the current cycle including the cycle time, remaining time, Delay Start settings, and other cycle-specific information.</p> <p>If a problem occurs during operation, an information code appears with a warning sound. Refer to the information codes on page 52.</p>

Operations

<p>10 Delay Start</p>	<p>Delay a cycle for up to 24 hours in one-hour increments. To increase the delay start time, press or hold the Delay Start button. The hour displayed indicates the time at which the wash will start.</p> <ul style="list-style-type: none"> - After setting the delay time, press the Start button, and then close the door to start the cycle. - To change the delay time after the dishwasher has started, first turn the dishwasher off and turn it back on. Then, select a new cycle and change the delay time settings.
<p>11 Start</p>	<p>To start a cycle, press the Start button before closing the door.</p> <p>Cancel & Drain: To cancel a currently running cycle and drain the dishwasher, press and hold the Start button for three (3) seconds. Once the dishwasher is reset, select a cycle and option, and then press Start to restart the dishwasher.</p>

Indicators



<p>Control Lock indicator</p>		<p>Lights up if Control Lock is activated, and blinks if any button except for the Power button is pressed.</p>
<p>AI Energy mode indicator</p>		<ul style="list-style-type: none"> • AI Energy mode becomes active when the SmartThings app allows it to be enabled. • With the AI Energy mode enabled, the indicator turns on if an AI Energy mode compatible cycle is selected. • Not all cycles are available with this mode. The indicator turns off if an AI Energy mode incompatible cycle is selected. • AI Energy mode helps reduce power consumption. However, it takes a longer cycle time.
<p>Rinse Refill indicator</p>		<p>Lights up if the dishwasher runs out of rinse aid.</p>
<p>Smart Control</p>		<p>Lights up if SmartThings is activated.</p>

Cycle overview

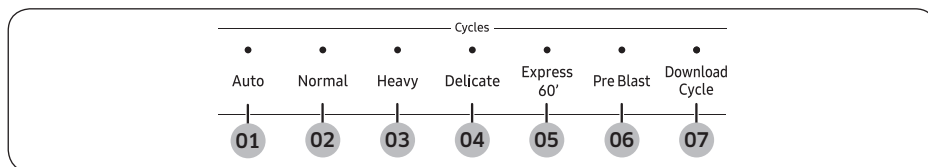

01 Auto	This cycle detects the level of soil and automatically initiates the optimal cycle after a few minutes of operation.
02 Normal	Use this cycle for normally soiled dishes. The energy-usage label is based on this cycle.
03 Heavy	Use this cycle for heavily soiled dishes.
04 Delicate	Use this cycle for soiled, fragile items such as fine glassware and crystal glass (wine glass). Do not use this cycle for other glassware because clouding or etching may occur.
05 Express 60'	Use this cycle when you need to wash dishes quickly. It takes about 1 hour.
06 Pre Blast	Use this cycle for dislodging large food debris roughly in a quick time and preventing caking. No detergent or rinse is applied.
07 Download Cycle	Beside the default cycles, you can download and use additional cycles on your smartphone.

Operations

Download Cycle

Beside the default cycles, you can download and use additional cycles on your smartphone.

1. Press **Power** button, and then select the **Download Cycle**.
2. Select a downloadable cycle on your smartphone app.
Cycles available: Plastic, Pots Pans, Baby Care, Night.
 - The default cycle is Plastic.
 - You can save the downloaded cycle for future use.
3. Press **Start** button, and close the door of the dishwasher.

Plastic	Appropriate for cleaning plastic dishes that are vulnerable to heat and temperature.
Pots Pans	Appropriate for cleaning cookware such as pans and pots that are likely to be soiled heavily.
Baby Care	Use this cycle to rinse dishes with high-temperature water before drying. No detergent is applied.
Night	Use this cycle for normal dishwashing after a meal. This cycle takes a longer time but less energy than the Normal cycle.



Simple steps to start your dishwasher

1. Open the door, and then load the dishwasher. Make sure dishes are empty.
2. If applicable, put the dishes in the lower rack. If adding the **Storm Wash+** option, put the dishes in the left side of the lower rack.
3. Add detergent to the detergent dispenser. For better results, add rinse aid to the rinse aid compartment.

 **NOTE**

You should use rinse aid for better drying performance. You can further improve drying performance by also selecting the **Sanitize** option.

4. Press **Power**, and then select a cycle with necessary options (Lower Rack, Storm Wash+, Hi-Temp Wash, Sanitize).
If you change the cycle after selecting an option, the original cycle is reset.
5. Press **Start**, and then close the door within 3 seconds. The dishwasher starts the cycle after draining for a few seconds.

 **NOTE**

- To change the cycle after it has started, press and hold **Start** for 3 seconds to cancel the cycle. Then, select a new cycle.
- To resume after you have opened the door to stop the dishwasher while operating, simply press **Start** first, and then close the door.



Operations

Settings

You can change the sound, Auto Release™ Dry alert, Rinse aid amount, and Auto Release™ Dry settings to your preference. To change the settings, press the **Sanitize** and **Delay Start** buttons simultaneously for 3 seconds. Press **Sanitize** to navigate through the sub menus, and then press **Delay Start** to confirm your changes.



After setting is finished, press **Power** button or **Sanitize** and **Delay Start** buttons.

Sound

Press **Sanitize** until 'U0' or 'U1' is displayed. To mute the dishwasher, select 'U0', and then press the **Sanitize** and **Delay Start** buttons at the same time or the **Power** button. To unmute, select 'U1', and then press the **Sanitize** and **Delay Start** buttons at the same time or the **Power** button.

Auto Release™ Dry alert

You can enable or disable the setting that alerts you when the door opens to start the Auto Release™ Dry function.

Press **Sanitize** until 'J1' or 'J0' is displayed. To disable the Auto Release™ alert, select 'J0', and then press the **Sanitize** and **Delay Start** buttons at the same time or the **Power** button. To enable, select 'J1', and then press the **Sanitize** and **Delay Start** buttons at the same time or the **Power** button.

Rinse aid amount

Press **Sanitize** until 'F0~F6' is displayed. The higher the number, the more rinse aid the dishwasher uses. To improve drying performance, select a higher number.

If your dishes appear discolored after a wash, switch to a lower number.

The factory default level is 'F4'.

NOTE

For DW80CG502* model, please press **Hi-Temp Wash** instead of **Sanitize**.

Auto Release™ Dry

The Auto Release™ Dry function, which is designed to improve drying performance, automatically opens the dishwasher's door 1 to 15 minutes before a cycle ends.

You can enable or disable Auto Release™ Dry in two ways: Using the Setting Mode or using the toggle keys. Both methods are described starting below.

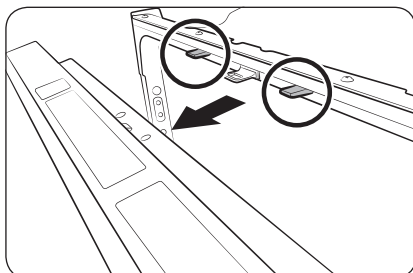

Press **Sanitize** until “A1” or “A0” is displayed. Then, press **Delay Start** to enable (A1) or disable (A0) Auto Release™ Dry.

Using the Toggle Keys :

DW80CG545*, DW80CG542*, DW80CB545* Series

Press the **Storm Wash + Sanitize** button for 3 second to enable (A1) or disable (A0) Auto Release™ Dry.

DW80CG502* Series

Press the **Lower Rack + Hi-Temp Wash** button for 3 second to enable (A1) or disable (A0) Auto Release™ Dry.

NOTE

- Once the door opens on the Auto Release™ Dry mode, the door cannot be closed manually for the next 2 minutes.
- Disabling (A0) “Auto Release™ Dry” can affect the drying results. Enable (A1) “Auto Release™ Dry” for better drying result.
- After a cycle is complete, the door automatically opens to let steam out. This is normal and not a product malfunction.
- For DW80CG502* model, please press **Hi-Temp Wash** instead of **Sanitize**.

Operations

SmartThings

Wi-Fi connection

On your smartphone, go to **Settings**, and then connect to your home Wi-Fi network.

Download

On an app market (Google Play Store, Apple App Store, Samsung Galaxy Apps), find the SmartThings app using “SmartThings” as the search term. Download and install the app on your device.

NOTE

- The SmartThings app is designed for Android 8.0 or later, iOS 13.0 or later.
- For improved performance, the SmartThings app is subject to change without notice, or discontinued support according to the manufacturer’s policy.

Log in

You must first log into SmartThings using your Samsung account. To create a new Samsung account, follow the instructions on the app. You don’t need a separate app to create your account.

NOTE

If you have a Samsung account, use the account to log in. A registered Samsung smartphone user automatically logs in.

To register your device to SmartThings

1. Make sure your smartphone is connected to a wireless network.
2. Run **SmartThings** on your smartphone. iPhone users are required to provide the login information each time they access the app.
3. When a message of “A new device is found.”, select **Add**.
4. If no message appears, select + and then select your dishwasher in a list of devices available. If your dishwasher is not listed, select **Device Type > Specific Device Model**, and then add your dishwasher manually.
5. Follow the on screen instructions to complete the connection process for your dishwasher. Press and hold **Smart Control** for more than 5 seconds until the “AP” message appears on the display. Your dishwasher will be registered with the app.
6. When the process is complete, your dishwasher will appear in the list of devices on your SmartThings App.
7. Tap the dishwasher icon to open the dishwasher page.
8. When a network connection is established, the Wi-Fi icon lights up on your dishwasher.



Dishwasher app

Integrated control: You can monitor and control your dishwasher both at home and on the go.

- Select the dishwasher icon on SmartThings. The dishwasher page appears.
- Check the operation status or notifications related to your dishwasher, and then change options or settings if necessary.

NOTE

- This device is designed for household use only (Class B), and can be used in all residential areas.
- This device may cause wireless interference, and neither the manufacturer or the installer of this device can provide a safety measure of any kind.
- Recommended encryption methods are WPA/TKIP and WPA2/AES. Newly developed Wi-Fi protocols or unapproved Wi-Fi protocols are not supported.
- The reception sensitivity of a wireless network may be affected by surrounding wireless environments.
- If your Internet provider has registered the MAC address of your PC or the modem module for permanent use, your Samsung dishwasher may fail to connect to the Internet. If this is the case, contact your Internet provider.
- The Internet firewall may interrupt your Internet connection. If this happens, contact your Internet provider.
- If your dishwasher still fails to connect to the Internet after you have followed the instructions of your Internet provider, contact a local Samsung retailer or service center.
- To install and set up your wired or wireless router, refer to the user manual that came with your router.
- Your Samsung dishwasher supports the Wi-Fi 2.4 GHz protocols.
- Your Samsung dishwasher supports the IEEE802.11 b/g/n (2.4 GHz), Soft-AP protocols. (IEEE802.11n is recommended)
- An unapproved wired/wireless router may fail to connect to your Samsung dishwasher.
- The SmartThings app is available on Android devices with OS 8.0 or higher and iOS devices with iOS 13 or higher. The app is optimised for Samsung smartphones (Galaxy S and Note series).
- Some functions of the app may operate differently on third-party devices.
- The app is subject to change without notice for improved performance.



Operations

SmartThings

Category	Checkpoint	Description
Monitoring	Washing status	You can check the current cycle and its options, and the remaining cycle time.
	Smart Control	The Smart Control status is shown for the dishwasher.
	Energy monitoring	Use this to monitor the energy consumption status.
Control	Start/Pause/Cancel	Select a cycle and necessary options, and then select Start/Pause/Cancel to start an operation, to stop temporarily, or to cancel the current operation.
	My Favorite	Add frequently used cycles and options to My Favorite for later use.
	Delay Start	Set Delay Start to start the cycle at a scheduled time. (Delay up to 24 hours.)
Notification	Cycle completed	Notifies you that the current cycle is complete.
	Detergent	Notifies you if the dishwasher is out of rinse aid.
Washing Recipe	Cycle recommendation	Recommends the best cycle with optimal options for loaded dishes.
Homecare Wizard	Maintenance	The wizard features a device management service and a usage guide.

Special features

Delay Start

You can delay the cycle starting time up to 24 hours in 1-hour increments. To increase the delay time, press **Delay Start**. The hour displayed indicates the time at which the cycle will start.

1. Open the door, and then load the dishwasher.
2. Press **Delay Start**, and then press or hold **Delay Start** to change the time in 1-hour increments.
3. Close the door, and then press **Start**.

NOTE

To change the delay time once the dishwasher has started, press **Power** and then restart the dishwasher.

Touch Controls

Touch controls allow you to operate the dishwasher easily.

- They are convenient to operate, requiring only a soft touch.
- Have a simple and stylish design.
- Are easy to clean.

NOTE

If you have children or you want to clean the Control Interface, we recommend activating the Control Lock feature to lock the control buttons.

Control Lock

To prevent children from playing with the dishwasher, Control Lock locks all button controls except for **Power**.

- To activate Control Lock, press and hold **Lock (3 sec)** for 3 seconds. With Control Lock activated, you cannot select a cycle or option, or start an operation.
- To deactivate Control Lock, press and hold **Lock (3 sec)** again for 3 seconds.
- Control Lock remains active after the dishwasher restarts. To cancel Control Lock, you must deactivate it first.



Maintenance

Cleaning

Keep the dishwasher clean to improve performance, reduce unnecessary repairs, and lengthen its lifecycle.

Exterior

Clean spills on the surface of the dishwasher as they occur. Use a soft, damp cloth on the control panel to gently wipe away spills and dust.

CAUTION

- Do not use benzene, wax, thinner, chlorine bleach, alcohol, or other chemical substances. These materials may discolour the surface of the dishwasher and cause stains.
- The dishwasher has electric parts inside. Do not sprinkle water directly onto the dishwasher. Protect electrical components from coming in contact with water.
- For a stainless-steel door panel, clean using a stainless steel cleaner for home appliances and a clean, soft cloth.

Interior

Clean the interior of the dishwasher on a regular basis to remove any dirt or food particles. Wipe inside the dishwasher and inside the door with a wet dishcloth. To maintain optimum cleanliness, we recommend running the Self Clean cycle periodically with the dishwasher empty.

To keep the cutlery pad clean, turn it over after each use. To remove white spots and odors from the cutlery pad, run the Self Clean cycle with the dishwasher empty and no detergent until the cutlery pad flushes. Then, stop the cycle and put an 8-ounce cup of white vinegar into the lower basket. Close the door, and then resume the cycle.

Use a damp cloth to remove lime scale or grease deposits inside the dishwasher. Alternatively, apply some detergent, and then run an empty cycle using the highest rinse temperature.

CAUTION

- Do not remove the front seal (the long rubber seal enclosing the opening of the dishwasher). The seal keeps the inner side of the dishwasher sealed.





Nozzles

To prevent the nozzles from being clogged or if the nozzles are clogged, remove and clean each nozzle. Use caution when removing the nozzles as they may break.

Top nozzle

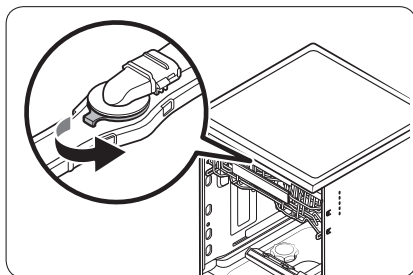

1. Open the door, and then pull out the upper rack. The top nozzle is visible on the top.
2. Turn counter clockwise and remove the **nozzle cap**, and then remove the nozzle.
3. Unclog and clean the nozzle.
4. Reinsert the nozzle, and then tighten the cap clockwise.
5. Rotate the nozzle by hand to make sure the nozzle is engaged correctly.

Upper nozzle

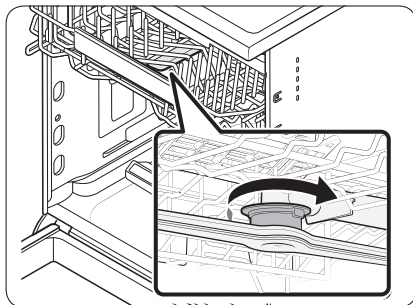

1. Open the door, and then pull out the upper rack to reveal the upper nozzle.
2. Loosen and remove the nut, and then remove the nozzle.
3. Unclog and clean the nozzle.
4. Reinsert the nozzle, and then tighten the nut by hand.
5. Rotate the nozzle by hand to make sure the nozzle is engaged correctly.



Maintenance

Lower nozzle

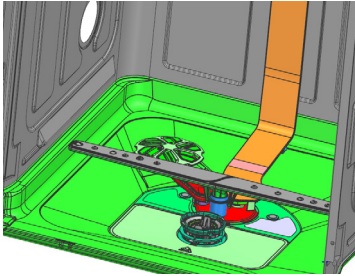

1. Open the door, and then pull out the lower rack. The lower nozzle is visible on the bottom.
2. Unclog and clean the nozzle.
3. Reinsert the nozzle.
4. Rotate the nozzle by hand to make sure the nozzle is engaged correctly.

Filter

We recommend cleaning the filter every month.

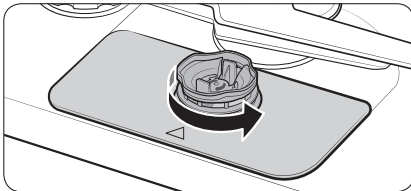

1. Open the door, and then remove the lower rack first.
2. Turn the filter handle counterclockwise to unlock the Coarse filter.

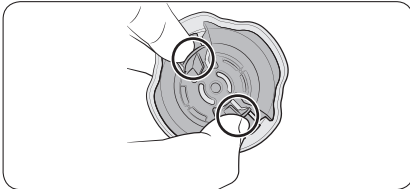
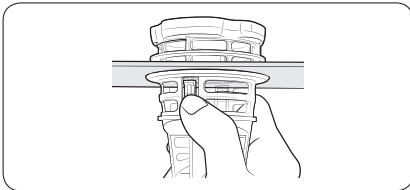
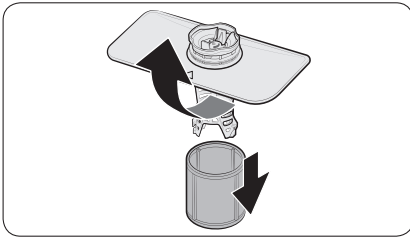
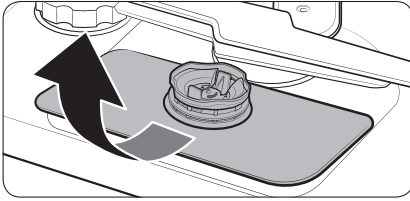

3. Remove the Coarse filter, and then the cylindrical micro filter underneath.

Maintenance

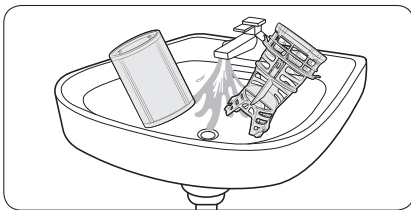

4. Remove any dirt and impurities from the micro filter and the Coarse filter.
5. Rinse both filters with running water, and then dry well.



6. Reinsert the filter, and then the Coarse filter.
7. Turn the filter handle clockwise to lock.

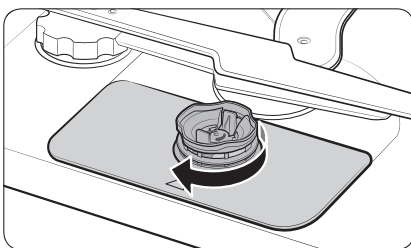

⚠ CAUTION

Make sure the Coarse filter is closed properly. A loose cover can reduce the filtering performance.

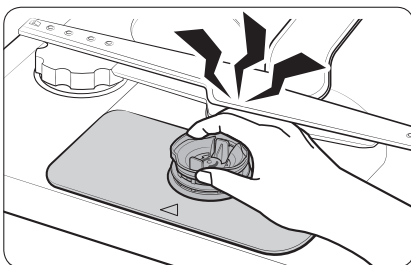

⚠ CAUTION

When removing the filter, the hand can be caught between the rotor and filter.

Long-term care

If you will not use the dishwasher for an extended period of time, first drain the unit completely, and then disconnect the water hose. Shut off the water supply valve and the circuit breaker. Water remaining in the hoses or the internal components can damage the dishwasher.

Cleaning the drain pump

If the dishwasher fails to drain (5C is displayed) because the drain pump is clogged with a foreign matter or there is an abnormal noise coming from the drain pump, you must unclog and clean the drain pump as instructed below.

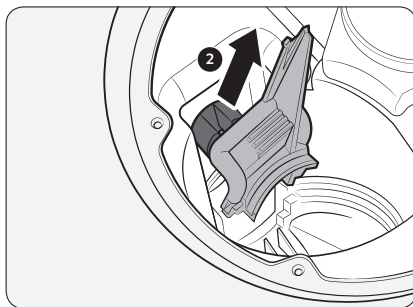
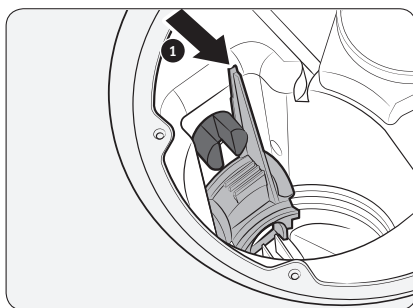

1. Remove the lower rack.
2. See the “Filter” section to remove the cylindrical micro filter.
3. Remove any moisture from the filter using a sponge.
4. Remove the drain-pump cover by pushing its handle in the direction of the arrow (1), and then pulling up (2).
5. Check the impeller to see if it’s in good condition. Then, remove any foreign matter from the pump.
6. Reinsert the drain-pump cover and then press down until you hear a click.

Maintenance

Storing your dishwasher

If you need to store your dishwasher for an extended period of time, first drain and disconnect it. If you leave water in the hoses and internal components, you can damage the dishwasher.

After draining and disconnecting the dishwasher, be sure to turn off the water supply valve and circuit breaker.

Troubleshooting

Check these solutions if your dishwasher...

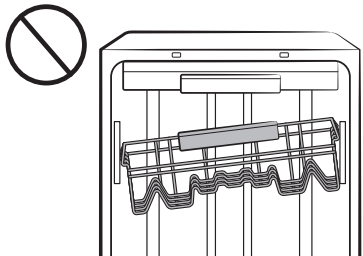
Problem	Possible cause	Solution
Will not start.	The door is not closed completely.	<ul style="list-style-type: none"> Check if the door is latched and closed completely. Check whether the Upper Rack is properly joined to the Duct Nozzle. Also, check if the Upper Rack is crooked or unbalanced. 
	The Start button was not pressed.	<ul style="list-style-type: none"> See the information code that appears on the display.
	Doesn't operate at all.	<ul style="list-style-type: none"> Make sure the power cable is connected properly.
	The water supply does not work.	<ul style="list-style-type: none"> Check if the water supply valve is open. Check if the supplied water pressure is between 20 and 120 psi (between 140 and 830 kPa).
	The Control Panel is locked.	<ul style="list-style-type: none"> Unlock the Control Lock, (See page 39.)
	A circuit breaker is open.	<ul style="list-style-type: none"> Reset the circuit breaker.
An operation or cycle is taking too long.	The dishwasher is connected to a cold water supply.	<ul style="list-style-type: none"> Check if the water supply line is connected to a cold water supply. To work properly, the dishwasher must be connected to a hot water supply. (If connected to a cold water supply, additional time is required to heat the cold water.)

Troubleshooting

Problem	Possible cause	Solution
There are food particles remaining on dishes. (Not cleaning properly.)	The cycle selected was unsuitable.	<ul style="list-style-type: none"> Select a cycle according to the number and soil level of the dishes, as directed in this manual.
	The water temperature is low.	<ul style="list-style-type: none"> Connect the water supply line to a hot water supply. For best performance, the temperature of the supplied water should be 120 °F (49 °C).
	Low water pressure.	<ul style="list-style-type: none"> The water pressure should be between 20 and 120 psi (140-830 kPa).
	The water is too hard.	<ul style="list-style-type: none"> Use a commercial dishwasher cleaner. Use high-quality, fresh detergent with rinse aid.
	Dishwasher detergent was not used.	<ul style="list-style-type: none"> Use automatic dishwasher detergent. We recommend a powder type or multi-function tablet dishwasher detergent.
	Detergent remains in the dispenser.	<ul style="list-style-type: none"> Make sure large items such as cookie sheets, cutting boards, or containers, etc. are not blocking the detergent dispenser and preventing it from opening properly. Rearrange the dishes so they do not interfere with detergent dispenser operation.

Problem	Possible cause	Solution
There are food particles remaining on dishes. (Not cleaning properly.)	There is no rinse aid.	<ul style="list-style-type: none"> • Check the dispenser and add rinse aid. • Use liquid type rinse aid.
	A nozzle is clogged.	<ul style="list-style-type: none"> • Clean the nozzle. See page 42.
	The dishes are improperly loaded. Too many dishes have been loaded.	<ul style="list-style-type: none"> • Rearrange the dishes so they do not interfere with nozzle rotation and detergent dispenser operation. • Load only an appropriate number of dishes. • Load your dishes as recommended. (See page 18.) • Load the heavily soiled items into the Storm Wash* area. (See page 19)
	The filters are clogged or not correctly fastened. (Food soils remain on the filter.)	<ul style="list-style-type: none"> • Scrape food from dishes prior to loading. (Do not pre-rinse.) • Clean the filter. (See page 42.) • Make sure the filters are correctly fastened.
	Less water than required is supplied.	<ul style="list-style-type: none"> • Check if the supplied water pressure is between 20 and 120 psi (between 140 and 830 kPa).
Leaves glasses with a light film.	The water supplied is soft and too much detergent was used.	<ul style="list-style-type: none"> • Underload the dishwasher and use a rinse aid to minimize this.
	Aluminum dishes were included in the wash load.	<ul style="list-style-type: none"> • Remove the marks on the dishes using a low sensitivity cleaner.
Leaves a yellow or brown film on the inside of the dishwasher.	This is caused by coffee and tea soils.	<ul style="list-style-type: none"> • Remove the soils using a spot cleaner. • Use a cycle with a higher temperature.

Troubleshooting

Problem	Possible cause	Solution
Does not dry dishes well.	There is no rinse aid in the dispenser or not enough rinse aid was used.	<ul style="list-style-type: none"> • Check the dispenser and add rinse aid. • Use a liquid type rinse aid. • Check the rinse aid settings.
	The temperature of the water is low when the dishwasher is running.	<ul style="list-style-type: none"> • Connect the water supply line to a hot water supply. • Use rinse aid with the Sanitize option.
	Too many dishes have been loaded.	<ul style="list-style-type: none"> • Proper loading of items can affect drying. • Load your dishes as recommended. (See page 18.)
	Glasses and cups with concave bottoms hold water. This water may spill onto other items when you unload.	<ul style="list-style-type: none"> • After finishing the cycle, empty the lower rack first and then the upper rack. This will prevent water dripping from the upper rack onto the dishes in the lower rack.
	Auto Release™ Dry is turned off.	<ul style="list-style-type: none"> • Turn Auto Release™ Dry on. • For DW80CG545*, DW80CG542*, DW80CB545* Press the Storm Wash* + Sanitize button for 3 seconds to access the Auto Release™ Dry menu. Select "A1" to activate Auto Release™ Dry. • For DW80CG502* Press the Lower Rack + Hi-Temp Wash button for 3 seconds to access the Auto Release™ Dry menu. Select "A1" to activate Auto Release™ Dry.
	Multiple detergent tablets were used without selecting the Sanitize option.	<ul style="list-style-type: none"> • Select the Sanitize option or use rinse aid.



Problem	Possible cause	Solution
Has a bad odor.	Water was left over from an incomplete cycle.	<ul style="list-style-type: none"> Clean the dishwasher by running the Heavy cycle with the dishwasher empty and no detergent.
	The Drain Hose is obstructed.	<ul style="list-style-type: none"> Contact a qualified service technician to remove any obstruction from the drain hose.
	The dishwasher is not used daily or soiled dishes are left in unit too long.	<ul style="list-style-type: none"> With the dishwasher empty and no detergent, place a glass with 8 ounces of vinegar upright into the lower rack, and then run a Heavy cycle.
Is too noisy.	Sound is generated when the dispenser cover is open and the drain pump is operating in an early stage.	<ul style="list-style-type: none"> This is normal operation.
	The dishwasher is not level.	<ul style="list-style-type: none"> Ensure the dishwasher is level.
	Foreign material (a screw, a plastic piece) is in the pump chamber.	<ul style="list-style-type: none"> Contact a qualified service technician to remove foreign material from the pump chamber.
	There is a 'chopping' sound because a nozzle is bumping against the dishes.	<ul style="list-style-type: none"> Rearrange the dishes.
	Less water than required is supplied.	<ul style="list-style-type: none"> Check if the supplied water pressure is between 20 and 120 psi (between 140 and 830 kPa).
Does not have a smoothly rotating nozzle.	Nozzle holes are clogged with food particles.	<ul style="list-style-type: none"> Clean the nozzle holes. (See page 42.)
	The nozzle is blocked by a dish or pot and cannot rotate.	<ul style="list-style-type: none"> After placing the dishes into the racks, rotate the nozzles by hand to check whether any of the dishes interfere with them.
Water won't pump out of the dishwasher.	The drain is clogged.	<ul style="list-style-type: none"> Clean the drain pump by removing the drain-pump cover. (See page 45.)



Troubleshooting

Problem	Possible cause	Solution
Has a bent upper rack after dishes are loaded.	The dishes are not loaded properly.	<ul style="list-style-type: none"> Load your dishes as recommended. (See page 18.)
Cannot close the door.	Auto Release™ Dry mode is in operation.	<ul style="list-style-type: none"> Once the door opens in the Auto Release™ Dry mode, the door cannot be closed manually for the next 2 minutes. You may close the door after 2 minutes.

Information codes

The Control Panel displays information codes to help you understand what is occurring with your dishwasher.

Code	Action
LC	<p>Leakage check.</p> <ul style="list-style-type: none"> If a water supply valve connection leak occurs, close the water supply valve and go to your house circuit breaker panel, set the dishwasher's circuit breaker switch to off, and then contact the installer to fix. If the problem continues, contact an authorized Samsung service center.
4C	<p>Water supply check.</p> <ul style="list-style-type: none"> Check if the water supply valve is closed or clogged, or is frozen. Also check if the supplied water pressure is less than required. If the problem continues, close the water supply valve, and then contact an authorized Samsung service center.
5C	<p>Drain check.</p> <ul style="list-style-type: none"> After closing the water supply valve, check whether the drain hose is clogged or folded. Also, check whether the drain hole inside the sump is clogged. If the problem continues, contact an authorized Samsung service center.
HC	<p>High temperature heating check.</p> <ul style="list-style-type: none"> Functional check. With the dishwasher empty, add detergent, and then run a cycle. If the problem continues, go to your house circuit breaker panel, set the dishwasher's circuit breaker switch to off, and then contact an authorized Samsung service center.

Code	Action
3C	Pump operation check. <ul style="list-style-type: none">Functional check. Turn off the dishwasher and try to start it again. If the problem continues, contact an authorized Samsung service center.
PC	Zone wash function check. <ul style="list-style-type: none">Functional check. Turn off the dishwasher and try to start it again. If the problem continues, contact an authorized Samsung service center.

For any codes not listed above, call 1-800-SAMSUNG (726-7864).

Cycle chart

Cycle		Auto	Normal	Heavy
Cycle sequence		Prewash ▶ Mainwash ▶ Rinse ▶ Hot Rinse ▶ Dry ▶ End	Prewash ▶ Mainwash ▶ Rinse ▶ Hot Rinse ▶ Dry ▶ End	Prewash ▶ Mainwash ▶ Rinse ▶ Hot Rinse ▶ Dry ▶ End
Temp [°F (°C)]	Main wash	122-140 (50-60)	113-144 (45-62)	149 (65)
	Hot Rinse *Sanitize 163 °F (73 °C)	140-149 (60-65)	129-144 (54-62)	149 (65)
Water consumption [gal (ℓ)]		4.0-5.3 (15.2-20.2)	2.6-5.3 (9.8-20.0)	5.4 (20.5)
Cycle time (min)		109-135	111-128	137
Available Options	Lower Rack	0	0	0
	Storm Wash*	0	0	0
	Hi-Temp Wash	0	0	0
	Sanitize	0	0	0
	SmartDry-High	0	0	0
	SmartDry-Low	0	0	0
	Delay Start	0	0	0

Cycle chart

Cycle		Delicate	Express 60'	Pre Blast
Cycle sequence		Prewash ▶ Mainwash ▶ Rinse ▶ Hot Rinse ▶ Dry ▶ End	Mainwash ▶ Rinse ▶ Hot Rinse ▶ Dry ▶ End	Prewash ▶ End
Temp [°F (°C)]	Main wash	122 (50)	131 (55)	-
	Hot Rinse *Sanitize 163 °F (73 °C)	131 (55)	131 (55)	-
Water consumption [gal (ℓ)]		4.3 (16.4)	2.9 (10.8)	1.1 (4.1)
Cycle time (min)		79	60	10
Available Options	Lower Rack	0	0	X
	Storm Wash*	X	0	X
	Hi-Temp Wash	X	0	X
	Sanitize	X	0	X
	SmartDry-High	0	0	X
	SmartDry-Low	0	0	X
	Delay Start	0	0	0

Cycle chart

Cycle chart

Cycle		SelfClean	Plastic	PotsPans
Cycle sequence		Prewash ▶ Mainwash ▶ Rinse ▶ Hot Rinse ▶ Dry ▶ End	Mainwash ▶ Rinse ▶ Hot Rinse ▶ Dry ▶ End	Prewash ▶ Mainwash ▶ Rinse ▶ Hot Rinse ▶ Dry ▶ End
Temp [°F (°C)]	Main wash	163 (73)	140 (60)	158 (70)
	Hot Rinse *Sanitize 163 °F (73 °C)	149 (65)	136 (58)	149 (65)
Water consumption [gal (ℓ)]		4.7 (17.9)	3.2 (12.2)	5.4 (20.6)
Cycle time (min)		119	94	146
Available Options	Lower Rack	X	0	0
	Storm Wash*	X	X	0
	Hi-Temp Wash	X	X	0
	Sanitize	X	X	0
	SmartDry-High	X	0	0
	SmartDry-Low	X	0	0
	Delay Start	0	0	0

Cycle chart

Cycle		BabyCare	Night
Cycle sequence		Hot Rinse ► Dry ► End	Prewash ► Mainwash ► Rinse ► Hot Rinse ► Dry ► End
Temp [°F (°C)]	Main wash	-	131 (55)
	Hot Rinse *Sanitize 163 °F (73 °C)	163 (73)	130 (54)
Water consumption [gal (ℓ)]		1.0 (3.8)	5.0 (19.1)
Cycle time (min)		89	150
Available Options	Lower Rack	X	0
	Storm Wash*	X	0
	Hi-Temp Wash	X	0
	Sanitize	X	0
	SmartDry-High	0	0
	SmartDry-Low	0	0
	Delay Start	0	0

- When you select the **Auto** or **Normal** cycle, running the **Prewash** and **Rinse** cycles depends on the soil level of the load.
- The water consumption and wash time varies depending on the steps or options you add, and on the pressure and temperature of the supplied water.
- When the Rinse Aid is empty, wash time and Last Rinse temperature can increase a little.

Cycle chart

Appendix

Helping the environment

- Your dishwasher is manufactured from recyclable materials. If you decide to dispose of it, please observe local waste disposal regulations. Cut off the power cable so that the appliance cannot be connected to a power source.
- Remove the door so that animals and small children cannot get trapped inside the appliance.
- Do not exceed the detergent quantities recommended in the detergent manufacturers' instructions.

Specifications

MODEL	DW80CG5450MTAA / DW80CG5450SRAA / DW80CG5420SRAA / DW80CG5420MTAA / DW80CG5020SRAA / DW80CB545012AA / DW80CB5450APAA / DW80CG5451SRAA / DW80CG5451MTAA	
Type	Built-in Dishwasher	
Power	120 V / 60 Hz AC only, 15 A circuit breaker	
Wash capacity	15 place settings 14 place settings (DW80CG5420*, DW80CG5020*)	
Used water pressure	20-120 psi (140-830 kPa)	
Rated power usage	Wash Motor	60-100 W
	Heater	1100 W
Dimensions (Width × Depth × Height)	23 ⁷ / ₈ × 25 × 33 ⁷ / ₈ in. (605 × 636 × 860 mm) (DW80CG5450****, DW80CG5420****, DW80CG5020****)	
	23 ⁷ / ₈ × 27 ⁵ / ₁₆ × 33 ⁷ / ₈ in. (605 × 693 × 860 mm) (DW80CG5451****)	
Weight (Unpacked)	87.08 lb (39.5 kg) (DW80CG5420**** / DW80CG5020****) 89.28 lb (40.5 kg) (DW80CG5450AP** / DW80CG545****) 94.14 lb (42.7 kg) (DW80CG545012**)	

Open Source Announcement

The software included in this product contains open source software.

The following URL http://opensource.samsung.com/opensource/SMART_TP1_0/seq/0 leads to open source license information as related to this product.



Warranty (U.S.A)

SAMSUNG DISHWASHER

LIMITED WARRANTY TO ORIGINAL PURCHASER WITH PROOF OF PURCHASE

This SAMSUNG brand product, as supplied and distributed by SAMSUNG ELECTRONICS AMERICA, INC. (SAMSUNG) and delivered new, in the original carton to the original consumer purchaser, is warranted by SAMSUNG against manufacturing defects in materials or workmanship for the limited warranty period, starting from the date of original purchase, of:

One (1) year parts and labor

Five (5) years, Printed Circuit Board, Racking and Stainless Door Liner & Tub for leakage (Parts Only)

This limited warranty is valid only on products purchased and used in the United States that have been installed, operated, and maintained according to the instructions attached to or furnished with the product. To receive warranty service, the purchaser must contact SAMSUNG at the address or phone number provided below for problem determination and service procedures. Warranty service can only be performed by a SAMSUNG authorized service center. The original dated bill of sale must be presented upon request as proof of purchase to SAMSUNG or SAMSUNG's authorized service center to receive warranty service.

SAMSUNG will provide in-home service within the contiguous United States during the warranty period at no charge, subject to availability of SAMSUNG authorized servicers within the customer's geographic area. If the product is located in an area where service by a SAMSUNG authorized servicer is not available, you may be responsible for a trip charge or required to bring the product to a SAMSUNG authorized service center for service.

To receive in-home service, product must be unobstructed and accessible to the service agent.

During the applicable warranty period, a product will be repaired, replaced, or the purchase price refunded, at the sole option of SAMSUNG. SAMSUNG may use new or reconditioned parts in repairing a product, or replace the product with a new or reconditioned product. Replacement parts and products are warranted for the remaining portion of the original product's warranty or ninety (90) days, whichever is longer. All replaced parts and products are the property of SAMSUNG and you must return them to SAMSUNG.

This limited warranty covers manufacturing defects in materials or workmanship encountered in normal household, noncommercial use of this product and shall not cover the following: damage that occurs in shipment, delivery, installation, and uses for which this product was not intended; damage caused by unauthorized modification or alteration of the product; product where the original factory serial numbers have been removed, defaced, changed in any way, or cannot be readily determined; cosmetic damage including scratches, dents, chips, and other damage to the product's finishes; damage caused by abuse, misuse, pest infestations, accident, fire, floods, or other acts of nature or God; damage caused by use of equipment, utilities, services, parts, supplies, accessories, applications, installations, repairs, external wiring or connectors not supplied or authorized by SAMSUNG; damage caused by incorrect electrical line current, voltage, fluctuations and surges; damage caused by failure to operate and maintain the product according to instructions; in-home instruction on how to use your product; and service to correct installation not in accordance with electrical or plumbing codes or correction of household electrical or plumbing (i.e., house wiring, fuses, or water inlet hoses).

The cost of repair or replacement under these excluded circumstances shall be the customer's responsibility.

Visits by an authorized servicer to explain product functions, maintenance or installation are not covered by this limited warranty. Please contact SAMSUNG at the number below for assistance with any of these issues.

EXCLUSION OF IMPLIED WARRANTIES

IMPLIED WARRANTIES, INCLUDING THE IMPLIED WARRANTIES OF MERCHANTABILITY OR FITNESS FOR A PARTICULAR PURPOSE, ARE LIMITED TO ONE YEAR OR THE SHORTEST PERIOD ALLOWED BY LAW. Some states do not allow limitations on how long an implied warranty lasts, so the above limitations or exclusions may not apply to you. This warranty gives you specific rights, and you may also have other rights, which vary from state to state.

Warranty (U.S.A)

LIMITATION OF REMEDIES

YOUR SOLE AND EXCLUSIVE REMEDY IS PRODUCT REPAIR, PRODUCT REPLACEMENT, OR REFUND OF THE PURCHASE PRICE AT SAMSUNG'S OPTION, AS PROVIDED IN THIS LIMITED WARRANTY. SAMSUNG SHALL NOT BE LIABLE FOR SPECIAL, INCIDENTAL OR CONSEQUENTIAL DAMAGES, INCLUDING BUT NOT LIMITED TO TIME WAY FROM WORK, HOTELS AND/OR RESTAURANT MEALS, REMODELING EXPENSES, LOSS OF REVENUE OR PROFITS, FAILURE TO REALIZE SAVINGS OR OTHER BENEFITS REGARDLESS OF THE LEGAL THEORY ON WHICH THE CLAIM IS BASED, AND EVEN IF SAMSUNG HAS BEEN ADVISED OF THE POSSIBILITY OF SUCH DAMAGES. Some states do not allow exclusion or limitation of incidental or consequential damages, so the above limitations or exclusions may not apply to you. This warranty gives you specific rights, and you may also have other rights, which vary from state to state.

SAMSUNG does not warrant uninterrupted or error-free operation of the product. No warranty or guarantee given by any other person, firm, or corporation with respect to this product shall be binding on SAMSUNG.

To obtain warranty service, please contact SAMSUNG at:

In USA

Samsung Electronics America, Inc.
85 Challenger Road
Ridgefield Park, NJ 07660
1-800-SAMSUNG (726-7864)
www.samsung.com/us/support

Memo

SAMSUNG



Scan the QR code* or visit
www.samsung.com/spsn
to view our helpful
How-to Videos and Live Shows

*Requires reader to be installed on your smartphone

bit.ly/samsungdishwashers

QUESTIONS OR COMMENTS?

COUNTRY	CALL	OR VISIT US ONLINE AT
U.S.A - Consumer Electronics	1-800-SAMSUNG (726-7864)	www.samsung.com/us/support
CANADA	1-800-SAMSUNG(726-7864)	www.samsung.com/ca/support (English) www.samsung.com/ca_fr/support (French)



DD68-00261A-00