



SALAMANDER
DESIGNS

Furniture Shaped By Your Needs®

COLLABORATION FURNITURE

BUNDLE SOLUTIONS



4 BAY, DUAL MONITOR LOW-PROFILE, WALL CABINET

D1/347AM2/

Low-profile, shallow depth cabinets are sleek, streamlined solutions for supporting AV/IT technology. Our innovative design conceals all equipment and cables, and simple installation allows them to be affixed to any wall without special preparation.

Available in a variety of styles.



DYO
DESIGN YOUR OWN

See our **full-line catalog** for more customizable credenzas or visit SalamanderDesigns.com/Commercial.





4 BAY, DUAL MONITOR, LOW-PROFILE WALL CABINET

D1/347AM2/

BUNDLE SOLUTIONS

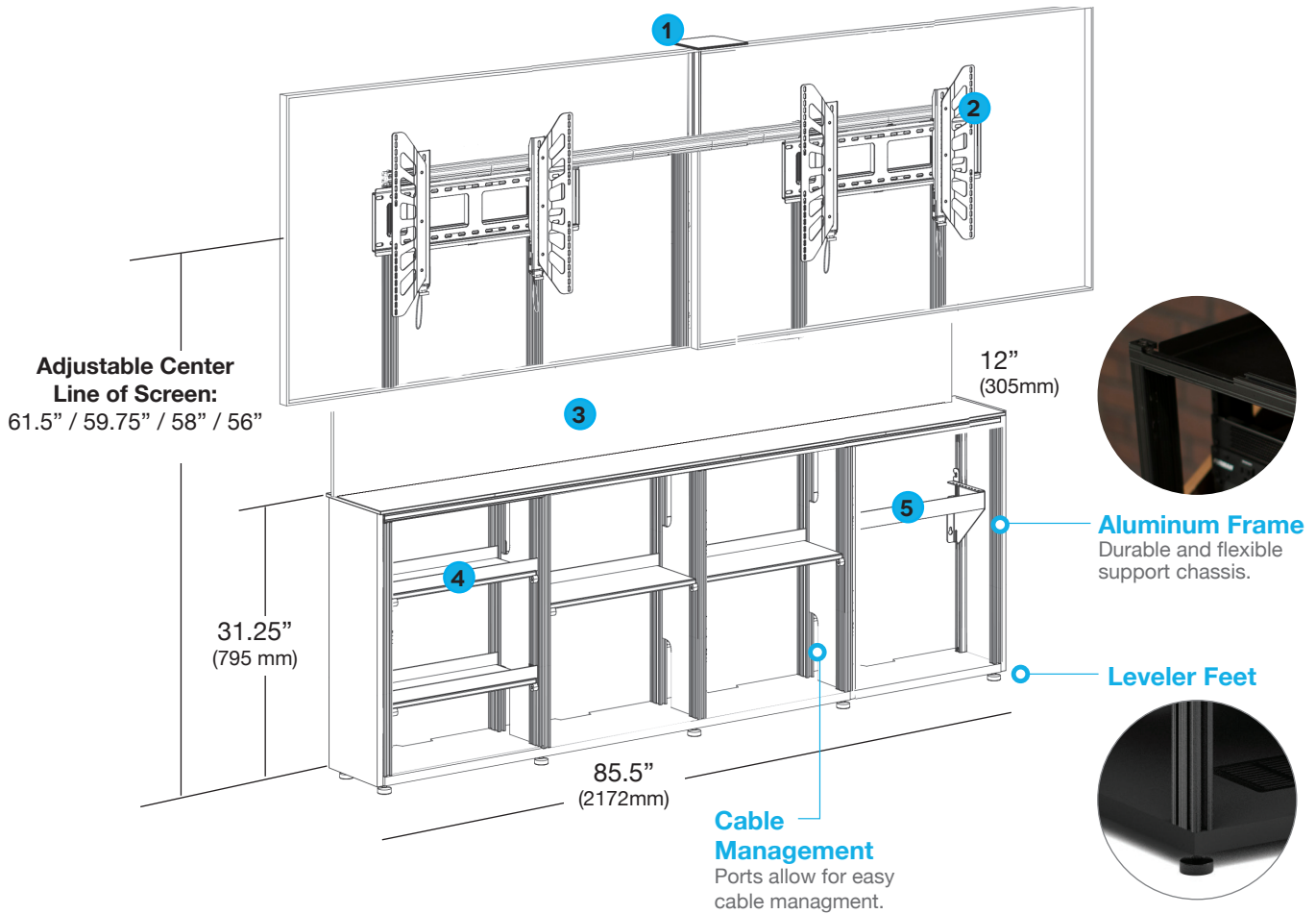

CABINET INCLUDES:

1. (1) Single Camera Shelf
2. (1) Dual Monitor Mount
3. (1) Black, Modesty Panel
4. (4) Adjustable Shelves and (6) Shelf Stops
5. (1) 3-U Vertical Rack

Typical Interior Bay Dimensions:

19.75"W (502 mm) x 27.75"H (705 mm) x 11"D (495 mm)

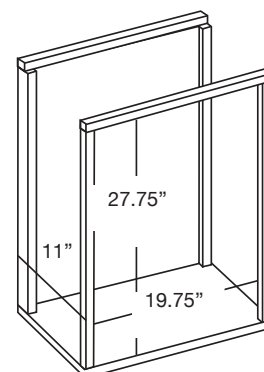



VIDEO INTEGRATION

Dual Monitor Mount

- Holds (2) 55-90", 125 lbs (57kg) ea
- Integrated mount with 11.75"H (298mm) black modesty panel
- Vesa Compliant: Horizontal 200 - 800 mm, Vertical 200 - 500 mm
- Adjustable mounting surface spaced at 5" min (127mm) distance from the wall. The width is adjustable to accommodate the screens listed. Overall height is 70" (1778mm) with wings and 65" (1651mm) to the top of the mount as shipped. all dimensions are subject to change based on style and feet.
- Adjustable Center Line of Screen:
61.5" (1562mm) / 59.75 (1518mm) / 58"(1473mm) / 56" (1422mm)

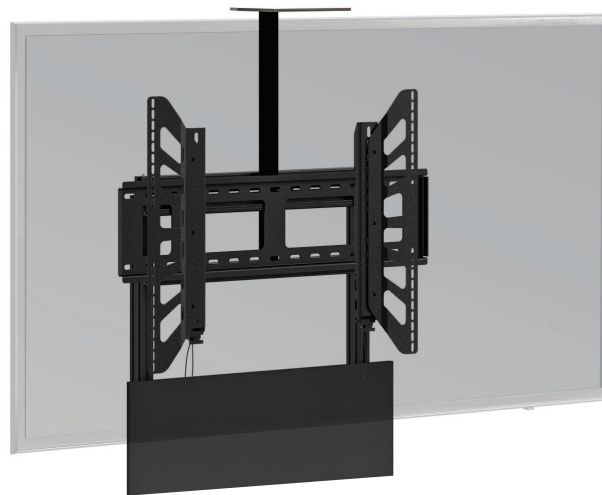

Camera Shelf

- Fully adjustable height.
- Single Shelf: 10"W (254mm) x 6"D (152mm) x .25"Th (6mm)
- Dual Shelf: 10"W (254mm) x 6"D (152mm) x .5"Th (13mm)
- Maximum Weight Capacity of 5 lbs (2 kgs)

Dual Camera Shelf Available
CA/CM/D

INTERIOR STORAGE

Adjustable Trays

- Measures: 19.75"W (502mm) x 7.875"D (200mm) x 1.5"H (38mm)
- Maximum Weight Capacity of 30 lbs (13.6 kgs)
- Constructed of 1/2" (12mm) MDF
- Shelves can be used flat or add a backstop or two to convert shelves to adjustable trays.
- Includes 4 Adjustable Trays and 6 shelf stops.





3-U VERTICAL RACK

- Rack is mounted to cabinet frame, for industry standard 19" pro audio rack mounting
- 3 rack units of vertical mounted, knob up component storage
- Threaded for 10-32 screws
- Black powder coated steel

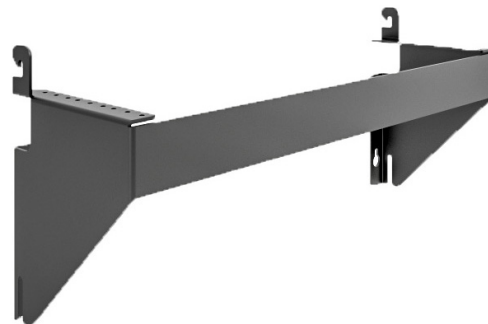

Length	572 mm	22.5 inch
Overall Height	419 mm	16.5 inch
Depth	190.5 mm	7.5 inch
Weight	3.63 kg	8 lbs
Capacity	81 kg	40 lbs

Wire Lacing Bars Available
RM/VR/3U

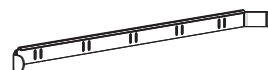



4 BAY, DUAL MONITOR, LOW-PROFILE WALL CABINET

D1/347AM2/

BUNDLE SOLUTIONS

STYLES

We select the finest materials and finishes. Choose from sleek, hand-polished, high-gloss finishes to richly textured real wood fronts. All styles come with standard leveler feet.

If you are looking for something different or special please contact us to discuss custom options.

TEXTURED



BERLIN
Wenge, Wave-Texture
Doors with 1/2" (12mm) Black,
Solid Surface
D1/347AM2/BL/WE



CHICAGO
Black Oak, Grass-Textured
Doors with 1/2" (12mm) Black,
Solid Surface
D1/347AM2/CH/BO



OSLO
Black Oak Sides, Black Glass
Doors with 1/2" (12mm) Black,
Solid Surface
D1/347AM2/OS/BG



DENVER - OAK
Natural Oak, Bark-Textured
Doors with 1/2" (12mm) Black,
Solid Surface
D1/347AM2/DV/NO



DENVER - WALNUT
Medium Walnut, Bark-Textured
Doors with 1/2" (12mm) Black,
Solid Surface
D1/347AM2/DV/MW



MIAMI - BLACK
Gloss Warm White
Doors with 1/2" (12mm) Black,
Solid Surface
D1/347AM2/MM/GW/BK



ZURICH
Linear Texture - Opium Brown
Doors with 1/2" (12mm) Black,
Solid Surface
D1/347AM2/ZU/OB



MIAMI - WHITE
Gloss Warm White
Doors with 1/2" (12mm) White
Solid Surface
D1/347AM2/MM/GW/WH