



| PZN3210U
LCD Monitor

USER'S GUIDE

www.planar.com

The information contained in this document is subject to change without notice. This document contains proprietary information that is protected by copyright. All rights are reserved. No part of this document may be reproduced, translated to another language or stored in a retrieval system, or transmitted by any means, electronic, mechanical, photocopying, recording, or otherwise, without prior written permission. Windows is a registered trademark of Microsoft Inc. Other brand or product names are trademarks of their respective holders.

| TABLE OF CONTENTS

FOR YOUR SAFETY	3
PRECAUTIONS	4
SPECIAL NOTES ON LCD MONITORS	6
BEFORE YOU OPERATE THE MONITOR	6
FEATURES	6
PACKAGE LIST	7
INSTALLATION INSTRUCTIONS	8
CONTROLS AND CONNECTORS	9
ADJUSTING THE VIEWING ANGLE	12
OPERATING INSTRUCTIONS	13
GENERAL INSTRUCTIONS	13
FRONT PANEL CONTROL	14
HOW TO ADJUST A SETTING	15
ADJUSTING THE PICTURE	16
PLUG AND PLAY	18
TECHNICAL SUPPORT (FAQ)	19
ERROR MESSAGE & POSSIBLE SOLUTION	20
APPENDIX	21
SPECIFICATIONS	21
FACTORY PRESET TIMING TABLE	22
CONNECTOR PIN ASSIGNMENT	24
WALL MOUNTING (OPTIONAL)	27
PLANAR SUPPORT	28

| FOR YOUR SAFETY

Before operating the monitor, please read this manual thoroughly. This manual should be retained for future reference.

FCC Class B Radio Frequency Interference Statement

WARNING: (FOR FCC CERTIFIED MODELS)

NOTE: This equipment has been tested and found to comply with the limits for a Class B digital device, pursuant to Part 15 of the FCC Rules. These limits are designed to provide reasonable protection against harmful interference in a residential installation. This equipment generates, uses and can radiate radio frequency energy, and if not installed and used in accordance with the instructions, may cause harmful interference to radio communications. However, there is no guarantee that interference will not occur in a particular installation. If this equipment does cause harmful interference to radio or television reception, which can be determined by turning the equipment off and on, the user is encouraged to try to correct the interference by one or more of the following measures:

1. Reorient or relocate the receiving antenna.
2. Increase the separation between the equipment and receiver.
3. Connect the equipment into an outlet on a circuit different from that to which the receiver is connected.
4. Consult the dealer or an experienced radio/TV technician for help.

NOTICE:

1. The changes or modifications not expressly approved by the party responsible for compliance could void the user's authority to operate the equipment.
2. Shielded interface cables and AC power cord, if any, must be used in order to comply with the emission limits.
3. The manufacturer is not responsible for any radio or TV interference caused by unauthorized modification to this equipment. It is the responsibilities of the user to correct such interference.

WARNING:

To prevent fire or shock hazard, do not expose the monitor to rain or moisture. Dangerously high voltages are present inside the monitor. Do not open the cabinet. Refer servicing to qualified personnel only.

This device complies with Part 15 of the FCC Rules. Operation is subject to the following two conditions: (1) This device may not cause harmful interference, and (2) this device must accept any interference received, including interference that may cause undesired operation.

Disposal of waste equipment by user in private household in the European Union



This symbol on the product or on its packaging indicates that this product must not be disposed of with your other household waste. Instead, it is your responsibility to dispose of your waste equipment by handing it over to a designated collection point for the recycling of waste electrical and electronic equipment. The separate collection and recycling of your waste equipment at the time of disposal will help to conserve natural resources and ensure that it is recycled in a manner that protects human health and the environment. For more information about where you can drop off your waste equipment for recycling, please contact your local city office, your household waste disposal service or the shop where you purchased the product.

PRECAUTIONS

- Do not use the monitor near water, e.g. near a bathtub, washbowl, kitchen sink, laundry tub, swimming pool or in a wet basement.
- Do not place the monitor on an unstable cart, stand, or table. If the monitor falls, it can injure a person and cause serious damage to the appliance. Use only a cart or stand recommended by the manufacturer or sold with the monitor. If you mount the monitor on a wall or shelf, use a mounting kit approved by the manufacturer and follow the kit instructions.
- Slots and openings in the back and bottom of the cabinet are provided for ventilation. To ensure reliable operation of the monitor and to protect it from overheating, be sure these openings are not blocked or covered. Do not place the monitor on a bed, sofa, rug, or similar surface. Do not place the monitor near or over a radiator or heat register. Do not place the monitor in a bookcase or cabinet unless proper ventilation is provided.
- The monitor should be operated only from the type of power source indicated on the label. If you are not sure of the type of power supplied to your home, consult your dealer or local power company.
- The monitor is equipped with a three-pronged grounded plug, a plug with a third (grounding) pin. This plug will fit only into a grounded power outlet as a safety feature. If your outlet does not accommodate the three-wire plug, have an electrician install the correct outlet, or use an adapter to ground the appliance safely. Do not defeat the safety purpose of the grounded plug.
- Unplug the unit during a lightening storm or when it will not be used for long period of time. This will protect the monitor from damage due to power surges.
- Do not overload power strips and extension cords. Overloading can result in fire or electric shock.
- Never push any object into the slot on the monitor cabinet. It could short circuit parts causing a fire or electric shock. Never spill liquids on the monitor.

- Do not attempt to service the monitor by yourself; opening or removing covers can expose you to dangerous voltages and other hazards. Please refer all servicing to qualified service personnel.
- To ensure satisfactory operation, use the monitor only with UL listed computers which have appropriate configured receptacles marked between 100 - 240V AC, Min. 5A.
- The wall socket shall be installed near the equipment and shall be easily accessible.
- Do not operate the product over 16 hours per day.
- Please confirm the distribution system in building installation shall provide the circuit breaker rated 120/240V, 20A (maximum).

Warning :

Stability Hazard.

The product may fall, causing serious personal injury or death. To prevent injury, this product must be securely attached to the floor/wall in accordance with the installation instructions.

A product may fall, causing serious personal injury or death. Many injuries, particularly to children, can be avoided by taking simple precautions such as:

- ALWAYS use cabinets or stands or installation methods recommended by the manufacturer of the product set.
- ALWAYS use furniture that can safely support the product.
- ALWAYS ensure the product is not overhanging the edge of the supporting furniture.
- ALWAYS educate children about the dangers of climbing on furniture to reach the product or its controls.
- ALWAYS route cords and cables connected to your product so they cannot be tripped over, pulled or grabbed.
- NEVER place a product in an unstable location.
- NEVER place the product on tall furniture (for example, cupboards or bookcases) without anchoring both the furniture and the product to a suitable support.
- NEVER place the product on cloth or other materials that may be located between the product and supporting furniture.
- NEVER place items that might tempt children to climb, such as toys and remote controls, on the top of the product or furniture on which the product is placed.

If the existing product is going to be retained and relocated, the same considerations as above should be applied.

SPECIAL NOTES ON LCD MONITORS

The following symptoms are normal with LCD monitor and do not indicate a problem.

NOTES AND CLEANING

- Due to the nature of the fluorescent light, the screen may flicker during initial use. Turn off the Power Switch and then turn it on again to make sure the flicker disappears.
- You may find slightly uneven brightness on the screen depending on the desktop pattern you use.
- The LCD screen has effective pixels of 99.99% or more. It may include blemishes of 0.01% or less such as a missing pixel or a pixel lit all of the time.
- Due to the nature of the LCD screen, an after image of the previous screen may remain after switching the image, when the same image is displayed for hours. In this case, the screen is recovered slowly by changing the image or turning off the Power Switch for hours.
- When the screen becomes black or flashing, or cannot illuminate any more, contact your dealer or service center to replace parts. Don't repair the screen by yourself!
- To keep the monitor looking new, periodically clean it with a soft cloth. Stubborn stains may be removed with a cloth lightly dampened with a mild detergent solution. Never use strong solvents such as thinner, benzene, or abrasive cleaners, since these will damage the cabinet. As a safety precaution, always unplug the monitor before cleaning it.
- Do not scratch the screen with hard things as it may cause permanent damage.
- Do not allow liquids into monitor as it will result in component damage.

BEFORE YOU OPERATE THE MONITOR

FEATURES

- 31.5" Wide Screen IPS Monitor
- Recommended Resolution: 3840 x 2160 @ 60Hz
- USB Type-C Docking Monitor
- Type-C, HDMI and Displayport Inputs
- Ethernet Lan up to 1G
- Ergonomic Design
- Space Saving, Compact Case Design
- KVM switch
- Integrated 2W speakers



Use extreme caution when unpacking your monitor as the deskstand is spring-loaded. Failure to follow the instructions below may lead to physical harm.

1. Lay the monitor flat on an even surface
2. Remove Styrofoam
3. Remove the bag.

PACKAGE LIST

The product package should include the following items:

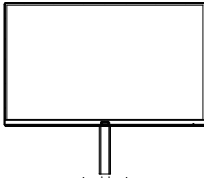

Monitor

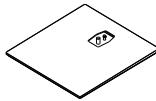

Stand base



User's Guide



Screw for Base



Power cable

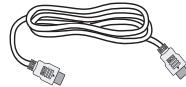

HDMI

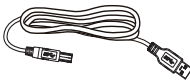

USB A-B cable



DP cable



Type-C cable

INSTALLATION INSTRUCTIONS

Attach the base organizer.

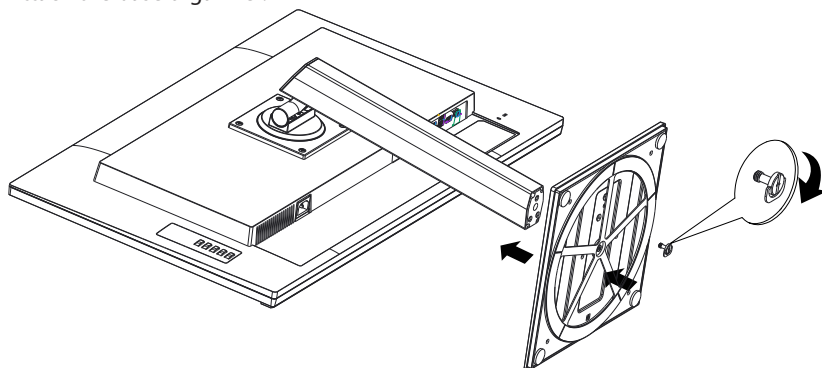

CONTROLS AND CONNECTORS

POWER CORD

Power Source:

1. Make sure that the power cord is the correct type required in your area.
2. This monitor has an internal universal power supply that allows operation in either 100/120V AC or 220/240V AC voltage area (No user adjustment is required.)
3. Connect the AC-power cord into the monitor's power input socket. The AC-power cord may be connected to either a wall power outlet or the power outlet socket on your PC, depending on the type of power cord supplied with your monitor.

SIGNAL CABLE

Connecting the Signal Cable : Plug one end of the signal cable to the LCD monitor and the other end to a computer or a video source (Type C, HDMI or DP).

Caution: If the AC outlet is not grounded (with three holes), install the proper grounding adapter (not supplied).

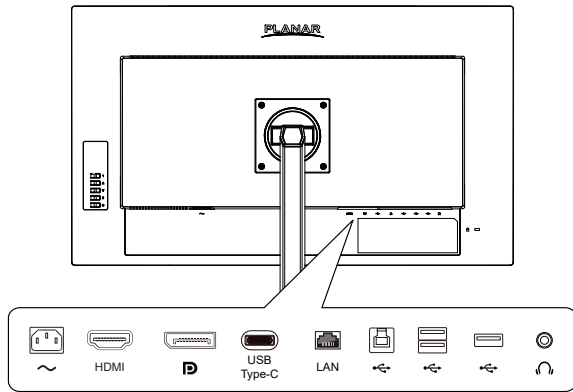

Connecting Cables

1.	Power Cable	6.	USB Type B cable
2.	HDMI Cable	7.	USB Cable
3.	DP Cable	8.	USB Cable
4.	Type-C Cable	9.	Headphone Cable
5.	Lan Cable		

Ethernet Connection

Connecting the Lan Cable: Connect one end of your Lan (RJ45) cable to the Lan (RJ45) port of the monitor. USB Type-C or Type-B cable must be connected.

USB Connection

Connect one end of a USB cable to a monitor and the other end to your computer.

Note: To utilize the USB Type A ports, ensure your computer is connected to the Type C and/or Type B port.

To comply with International energy standards, the USB hub/ports of this display are disabled during Standby and Off modes. Connected USB devices will not work in this state. To permanently put the USB function in "ON" state, please go to OSD Menu, then select "USB standby mode", and switch it to "ON" state. In OSD-->Extra-->USB Standby Power-->On/Off

Turning off the monitor via power switch will power Off all the USB ports.

Resolution

This monitor supports a native resolution of 3840 x 2160 @60 Hz. To support this resolution, the USB default setting is set to USB 2.0.

Note: The resolution supported by USB 3.2 is 3840 x 2160 @ 30Hz. Switch to USB 2.0 if your connection thru the lan port or connected USB devices seem slow.

KVM Switch

The KVM switch allows you to control two separate PCS with one monitor-keyboard-mouse set up.

Connect both USB upstream cables from 2 different PCs, one to the USB Type C port, the other to the USB type B port. Connect USB peripherals to the USB A (Downstream) ports to the monitor. See figure below.

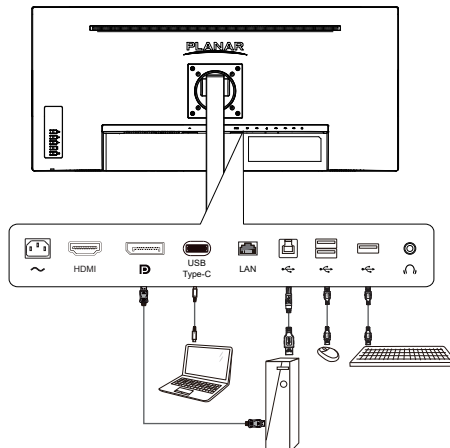

The default setting is set to USB C. To switch to USB B, toggle between USB Type C or USB Type B either by using the KVM hotkey (holding [2] button for 5 seconds), or in OSD-->Extra-->KVM USB-B/USB-C

Note: Power to the USB hub is dependent on which USB is active. Active USB must be connected in order for USB hub to be powered.

ADJUSTING THE VIEWING ANGLE

- For optimal viewing it is recommended to look at the full face of the monitor, then adjust the monitor's angle to your own preference.
- Hold the stand so you do not topple the monitor when you change the monitor's angle.
- You are able to adjust the monitor's swivel from -180° to 180° .
- You are able to adjust the monitor's tilt from -5° to 20° .
- You are able to adjust the monitor's pivot from 0° to 90° .

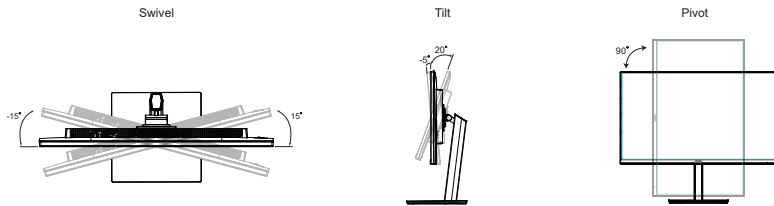

Figure 3

NOTES

- Do not touch the screen when you change the angle. It may cause damage or break the screen.
- Careful attention is required not to catch your fingers or hands when you change the angle.

OPERATING INSTRUCTIONS

GENERAL INSTRUCTIONS

The control buttons are located at the back of the monitor (See Figure 4). Press the power button to turn the monitor on or off. By changing these settings, the picture can be adjusted to your personal preferences.

- The power cord should be connected.
- Connect the video cable from the monitor to the video card.
- Press the power button to turn on the monitor. The power indicator will light up.

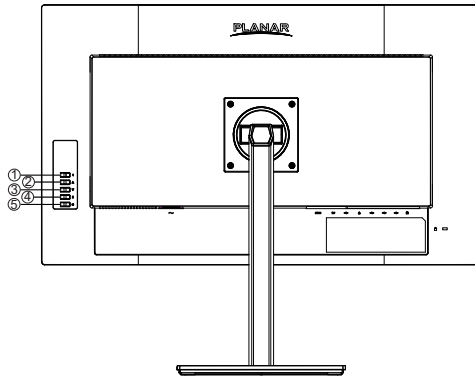

Figure 4 External Control Button

1.	OSD On / Off / Exit Selection
2.	Scroll Up / Adjust Increase / Blue Light Reducer / Volume
3.	Scroll Down / Adjust Decrease / ECO
4.	Input select / Confirm selection / KVM Switch
5.	Power On / Off

FRONT PANEL CONTROL

- **Power Button:**
Press this button to switch ON/OFF monitor's power.
- **Power Indicator:**
Blue — Power on mode.
Orange — Power saving mode.
- **[1]: OSD / Exit:**
Activates OSD menu or exit selection.
- **▲: Volume / Blue Light Reducer:**
Activates the volume control when the OSD is OFF or navigate through adjustment icons when OSD is ON or adjust a function when function is activated.
Blue Light Reducer hot key: When the OSD is OFF, press and hold the up key for 3 seconds will be Blue Light Reducer function.
- **▼: ECO**
Activates the ECO control when the OSD is OFF or navigate through adjustment icons when OSD is ON or adjust a function when function is activated.
- **[2]: Input Select / Enter:**
When the OSD is OFF, pressing [2] button will call out input select. Use the up/down arrow to select input. Press [2] to confirm selection.
KVM Switch hot key: When the OSD is OFF, press and hold down [2] button for 5 seconds will toggle between USB Type-C and USB Type-B
OSD Lock Function: All 4 buttons are locked except Power button. Hold the [1] button for 5 seconds to lock/unlock.
Power & OSD Lock Function: All 5 buttons including the Power button are locked. Hold the Power key for 5 seconds to lock/unlock.

NOTES

- Do not install the monitor in a location near heat sources such as radiators or air ducts, or in a place subject to direct sunlight, or excessive dust or mechanical vibration or shock.
- Save the original shipping carton and packing materials, as they will come in handy if you ever have to ship your monitor.
- For maximum protection, repackage your monitor as it was originally packed at the factory.

HOW TO ADJUST A SETTING

1. Press the [1] button to activate the OSD window.
2. Press ▲ or ▼ to navigate through the functions. Once the desired function is highlighted, press the [2] button to activate it. If the function selected has a sub-menu, press ▲ or ▼ again to navigate through the sub-menu functions. Once the desired function is highlighted, press [2] button to activate it.
3. Press ▲ or ▼ to change the settings of the selected function. To exit and save, select the [1] function.
4. If you want to adjust any other function, repeat steps 2-3.

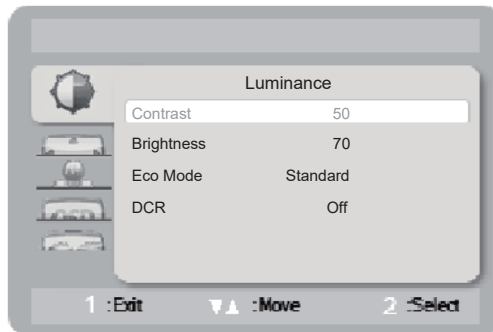







Figure 5 The OSD Message

ADJUSTING THE PICTURE

Main Menu Item	Main Menu Icon	1 st Sub Menu Item	Description
Luminance		Contrast	Adjusts contrast levels.
		Brightness	Adjusts backlight levels.
		Eco Mode	Picture Adjustment, Standard: Brightness = 60, Contrast = 50. Brightness, Contrast Adjustable
			Text: Brightness = 20, Contrast = 50. Brightness, Contrast Grayed.
			Internet: Brightness = 40, Contrast = 50. Brightness, Contrast Grayed.
			Game: Brightness = 60 Contrast = 50, Brightness, Contrast Grayed.
			Movie: Brightness = 80, Contrast = 50, Brightness, Contrast Grayed.
		Sports: Brightness = 100, Contrast = 50, Brightness, Contrast Grayed.	
DCR	Dynamic contrast ratio.		
Image Setup		Image Ratio	Select Image Aspect Ratio.
		OD	Overdrive Adjustment. .
		Color Range	Select color range only for HDMI.
		Adaptive Sync	Adaptive Sync On/OFF

Main Menu Item	Main Menu Icon	1 st Sub Menu Item	Description
Color Temp.		Warm	Recall Warm Color Temperature .
		Normal	Recall Normal Color Temperature .
		Cool	Recall Cool Color Temperature .
		User	Adjust R.G.B levels as desired. User-R:Red Gain from Digital-register. User-G:Green Gain from Digital-register. User-B:Blue Gain from Digital-register.
		sRGB	Recall sRGB Color Temperature
		Blue Light Reducer	(15% reduction) - VIDEO – Ideal for watching videos (30% reduction) - WEB BROWSING – Ideal for web browsing (50% reduction) - READING – Ideal for reading (70% reduction)- LOW LIGHT – Ideal for low ambient lighting environments
OSD Setup		H. Position	Adjust the horizontal position of the OSD.
		V. Position	Adjust the vertical position of the OSD.
		Timeout	Adjust the OSD timeout.
		Language	Set OSD display language .
Extra		Input Select	Select input.
		DDC/CI	Select DDC/CI On / Off.
		USB	USB2.0/USB3.2 (Default: USB 2.0)
		KVM	USB-B/USB-C (Default: USB-C)
		USB Standby Power	ON/OFF
		Reset	Set Monitor to default status.
		Information	Show the resolution, H/V as above format including all video timing.

PLUG AND PLAY

Plug & Play DDC2B Feature

This monitor is equipped with VESA DDC2B capabilities according to the VESA DDC STANDARD. It allows the monitor to inform the host system of its identity and, depending on the level of DDC used, communicate additional information about its display capabilities.

The DDC2B is a bidirectional data channel based on the I²C protocol. The host can request EDID information over the DDC2B channel.

THIS MONITOR WILL APPEAR TO BE NON-FUNCTIONAL IF THERE IS NO VIDEO INPUT SIGNAL. IN ORDER FOR THIS MONITOR TO OPERATE PROPERLY, THERE MUST BE A VIDEO INPUT SIGNAL.

This monitor meets the Green monitor standards as set by the Video Electronics Standards Association (VESA) and The Swedish Confederation Employees (NUTEK). This feature is designed to conserve electrical energy by reducing power consumption when there is no video-input signal present. When there is no video input signal this monitor, following a time-out period, will automatically switch to an OFF mode. This reduces the monitor's internal power supply consumption. After the video input signal is restored, full power is restored and the display is automatically redrawn. The appearance is similar to a "Screen Saver" feature except the display is completely off. The display is restored by pressing a key on the keyboard, or clicking the mouse.

USING THE RIGHT POWER CORD :

The accessory power cord for the Northern American region is the wallet plug with NEMA 5-15 style and is UL listed and CSA labeled. The voltage rating for the power cord shall be 125 volts AC.

Supplied with units intended for connection to power outlet of personal computer: Please use a cord set consisting of a minimum No. 18 AWG, type SJT or SVT three conductors flexible cord. One end terminates with a grounding type attachment plug, rated 10A, 250V, CEE-22 male configuration. The other end terminates with a molded-on type connector body, rated 10A, 250V, having standard CEE-22 female configuration.

Please note that power supply cord needs to use VDE 0602, 0625, 0821 approval power cord in European countries.

TECHNICAL SUPPORT (FAQ)

Problem & Question	Possible Solution
Power LED is not on	<ul style="list-style-type: none"> * Check if the Power Switch is in the ON position. * Power Cord should be connected.
No Plug & Play	<ul style="list-style-type: none"> * Check if the PC system is Plug & Play compatible. * Check if the Video Card is Plug & Play compatible. * Check if the D-15 plug pin of Video Cable is bent.
Picture is fuzzy	<ul style="list-style-type: none"> * Adjust the Contrast and Brightness Controls.
Picture bounces or a wave pattern is present in the picture	<ul style="list-style-type: none"> * Move electrical devices that may cause electrical interference.
The power LED is ON (Amber) but there's no video or no picture.	<ul style="list-style-type: none"> * Computer Power Switch should be in the ON position. * Computer Video Card should be snugly seated in its slot. * Make sure monitor's video cable is properly connected to the computer. * Inspect monitor's video cable and make sure none of the pins are bent. * Make sure computer is operational by hitting the CAPS LOCK key on the keyboard while observing the CAPS LOCK LED. The LED should either turn ON or OFF after hitting the CAPS LOCK key. * If connected to USB Type C, make sure USB standby is set to On.
Missing one of the primary colors (RED, GREEN, or BLUE)	<ul style="list-style-type: none"> * Inspect the monitor's video cable and make sure that none of the pins are bent.
Picture has color defects (white does not look white)	<ul style="list-style-type: none"> * Adjust RGB color or select color temperature.
Poor brightness or contrast	<ul style="list-style-type: none"> * When the brightness of the screen lowers after being used for a certain period and the function of the display is affected, send it to our authorized service center for repair.
No power for USB hub	<ul style="list-style-type: none"> * Make sure KVM switch is switched to active USB upstream source. * Make Sure USB standby is set to On.
Connected USB devices and Ethernet speed is slow	<ul style="list-style-type: none"> * Change USB setting from USB2.0 to USB3.2

ERROR MESSAGE & POSSIBLE SOLUTION

NO SIGNAL:

1. Check that the signal-cable is properly connected, if the connector is loose, tighten the connector's screws.
2. Check the signal-cable's connection pins for damage.
3. Check to see if connected device supports Type C.

INPUT NOT SUPPORT:

Your computer has been set to unsuitable display mode, set the computer to display mode given in the following table.

APPENDIX

SPECIFICATIONS

LCD Panel	Driving system	TFT Color LCD
	Size	80 cm(31.5")
	Pixel pitch	0.18159 (H) x 0.18159 (V) mm
Input	Video	Digital
	H-Frequency	30 – 135 kHz
	V-Frequency	24 - 75 Hz
Display Colors		16.7 M
Max. Resolution		3840 x 2160 @ 60Hz
Plug & Play		DDC 1/ 2B / CI or VESA DDC2B™
Power Consumption	Power On(typ.)	≤ 35 W
	Power Saving	≤ 0.5 W
	Power Off	≤ 0.3 W
Input Connector		20-pin Displayport 19-pin HDMI USB Type-C RJ45 USB Type-B 3 x USB Type A
Input Video Signal		1xDisplayPort 1.2 1xHDMI 2.0 *1 1xUSB type-C
Output Connector		1xHeadphone out
Speaker		2W x 2
USB		USB-C x 1 (Upstream) (5Gbps) USB B 3.2 (Gen 1) x 1 (Upstream) (5Gbps) USB A 3.2 Gen 1 x 3 (Downstream)
USB C Power Delivery		USB C (PD 65W) (5V/3A, 9V/3A, 12V/3A, 15V/3A, 20V/3.25A)
RJ45		Ethernet LAN (10M/100M/1000M)
Power Source		100~240VAC,50/60Hz
Environmental Considerations		Operating Temp: 0°C to 40°C Non-Operating Temp.: -20°C to 60°C Operating Humidity: 10% to 85%
Dimensions (W x H X D)		715.2 mm x 601.7 mm x 160.62 mm
Weight (N.W.)		9.95 kg

FACTORY PRESET TIMING TABLE

Preset HDMI/Displayport/Type C Modes			
Standard	Resolution (Hz)	HDMI	DP
VGA	640 × 480 @ 60	V	V
VGA	640 × 480 @ 67	V	V
VGA	640 × 480 @ 72	V	V
VGA	640 × 480 @ 75	V	V
DOS	720 × 400 @ 70	V	V
SVGA	800 × 600 @ 56	V	V
SVGA	800 × 600 @ 60	V	V
SVGA	800 × 600 @ 72	V	V
SVGA	800 × 600 @ 75	V	V
XGA	1024 × 768 @ 60	V	V
XGA	1024 × 768 @ 70	V	V
XGA	1024 × 768 @ 75	V	V
SXGA	1280 × 800 @ 60	V	V
SXGA	1280 × 1024 @ 60	V	V
SXGA	1280 × 1024 @ 75	V	V
WXGA+	1440 × 900 @ 60	V	V
WXGA+	1440 × 900 @ 75	V	V
WSXGA+	1680 × 1050 @ 60	V	V
FHD	1920 × 1080 @ 60	V	V
FHD	1920 × 1200 @ 60	V	V
UHD	3840 × 2160 @ 60	V	V

Video Timing Resolution			
480p	640 × 480p @ 60	V	V
480p	720 × 480p @ 60	V	V
576p	720 × 576p @ 50	V	V
720p	1280 × 720p @ 50	V	V
720p	1280 × 720p @ 60	V	V
1080p	1920 × 1080p @ 50	V	V
1080p	1920 × 1080p @ 60	V	V
1080p	2560 × 1080p @ 60	V	V
1400p	2560 × 1440p @ 30	V	V
1400p	2560 × 1440p @ 60	V	V
2160p	3840 × 2160p @ 30	V	V

CONNECTOR PIN ASSIGNMENT

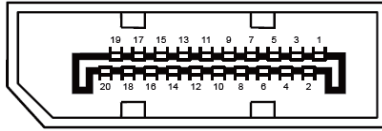

20 - Pin Color Display Signal Cable

PIN NO.	DESCRIPTION	PIN NO.	DESCRIPTION
1	ML_Lane 3 (n)	11	GND
2	GND	12	ML_Lane 0 (p)
3	ML_Lane 3 (p)	13	CONFIG1
4	ML_Lane 2 (n)	14	CONFIG2
5	GND	15	AUX_CH(p)
6	ML_Lane 2 (p)	16	GND
7	ML_Lane 1 (n)	17	AUX_CH(n)
8	GND	18	Hot Plug Detect
9	ML_Lane 1 (p)	19	Return DP_PWR
10	ML_Lane 0 (n)	20	DP_PWR

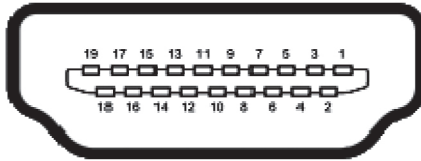

19 - Pin Color Display Signal Cable

PIN NO.	DESCRIPTION	PIN NO.	DESCRIPTION
1.	TMDS Data 2+	11.	TMDS Clock Shield
2.	TMDS Data 2 Shield	12.	TMDS Clock-
3.	TMDS Data 2-	13.	CEC
4.	TMDS Data 1+	14.	Reserved (N.C. on device)
5.	TMDS Data 1 Shield	15.	SCL
6.	TMDS Data 1-	16.	SDA
7.	TMDS Data 0+	17.	DDC/CEC Ground
8.	TMDS Data 0 Shield	18.	+5V Power
9.	TMDS Data 0-	19.	Hot Plug Detect
10.	TMDS Clock+		

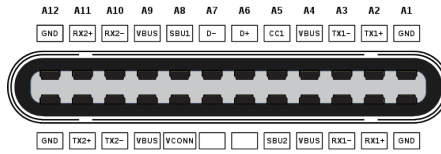

PIN No.	Signal Assignment	PIN No.	Signal Assignment
A1	GND	B12	GND
A2	SSTXp1	B11	SSRXp1
A3	SSTXn1	B10	SSRXn1
A4	VBUS	B9	VBUS
A5	CC1	B8	SBU2
A6	Dp1	B7	Dn2
A7	Dn1	B6	Dp2
A8	SBU1	B5	CC2
A9	VBUS	B4	VBUS
A10	SSRXn2	B3	SSTXn2
A11	SSRXp2	B2	SSTXp2
A12	GND	B1	GND

WALL MOUNTING (OPTIONAL)

Refer to the instructions that come with the base mounting kit. To convert your display from a desk-mounted to a wall-mounted display, do the following:

1. Verify that the power button is turned Off, then disconnect the power cord.
2. Remove the plastic covers from the back of the display.
3. Remove the four screws attaching the base (screw dimension: M4 x 12mm).
4. Attach the mounting bracket from the VESA compatible wall mounting kit (100 mm x 100 mm distance), VESA Mounting Screw M4x15mm.
5. Attach the display to the wall, following the instructions in the wall-mounting kit.

NOTE: For use only with wall mount bracket with minimum weight/load: 26.5lb (12kg.)

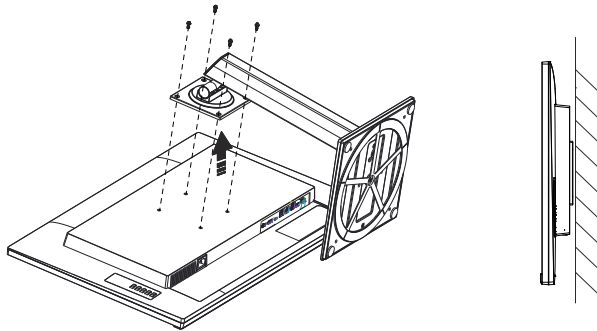

| PLANAR SUPPORT

Cables and Accessories

To find cables and accessories for your Planar monitor, touch screen or other Planar products visit our online store at www.PlanarOnline.com

Technical Support

Visit Planar at <http://www.planar.com/support> for operations manuals, touch screen drivers, warranty information and access to Planar's Technical Library for online troubleshooting.

To speak with Planar Customer Support please have you model and serial number available and dial:

Planar Support

Tel: 1-866-PLANAR1 (866-752-6271) or +1 503-748-5799 outside the US.

Hours: 24 hours a day, 7 days a week.

Toll or long distance charges may apply.

European Product Database for Energy Labeling (EPREL)

PZN3210U Registration number: 857651

Planar Systems, Inc.

Customer Service

24x7 Online Technical Support: <http://www.planar.com/support>

Planar Address: 1195 NE Compton Drive, Hillsboro, OR 97006 USA

Tel: 1-866-PLANAR1 (866-752-6271), or +1 503-748-5799 outside the United States,

Hours: 24 hours a day, 7 days a week

©2021 Planar Systems, Inc.

Planar is a registered trademark of Planar Systems, Inc. Other brands and names are the property of their respective owners. Technical information in this document is subject to change without notice.



Q41G32M193502A