

Planar PS Series 4K Displays



PS5074K	PS5074K-N
PS5074KT	PS5074KT-N
PS5574K	PS5574K-N
PS5574KT	PS5574KT-N
PS6574K	PS6574K-N
PS6574KT	PS6574KT-N

Copyright © July 2020 by Planar Systems, Inc.
All rights reserved.

This document may not be copied in any form without permission from Planar. Information in this document is subject to change without notice.

Trademark Credits

Windows™ is a trademark of Microsoft Corp.
All other companies are trademarks or registered trademarks of their respective companies.

Disclaimer

The information contained in this document is subject to change without notice. Planar Systems, Inc. makes no warranty of any kind with regard to this material. While every precaution has been taken in the preparation of this manual, the Company shall not be liable for errors or omissions contained herein or for incidental or consequential damages in connection with the furnishing, performance, or use of this material.

Warranty and Service Plans

Planar warranty and service plans will help you maximize your investment by providing great support, display uptime, and performance optimization. From post-sale technical support, to a full suite of depot services, our services are performed by trained employees. When you purchase a Planar product, you get more than a display; you get the service and support you need to maximize your investment. To find the latest warranty and service information regarding your Planar product, please visit <http://www.planar.com/support>

Part Number: 020-1384-00C

Table of Contents

Introduction	5
1. Safety Information	6
2. Safety Precautions	6
2.1 Important Safety Instructions:.....	7
3. Recommended Usage	8
3.1 Burn-In Versus Temporary Image Retention	8
3.2 Warranty Coverage	8
3.3 Important Waste Disposal Information	9
3.4 Normal Usage Guidelines	9
4. VESA Mounts, General Description.....	10
5. Cleaning the Display	11
Package Contents	12
6. Installing the Cable Clips.....	14
7. Standard Inputs	15
Installing the Display	16
8. Before You Begin	16
8.1 Tools/Equipment List.....	16
8.2 Other Things You May Need.....	16
8.3 Plan Your Installation.....	16
8.4 Prepare Your Installation Location	17
8.5 Cable Length Recommendations.....	17
Operating the Display	18
9. OSD Keypad.....	18
10. Remote Control Receiver.....	19
11. Installing IR Extender	20
12. LED Indicators.....	21
13. Using the Display in Portrait Mode.....	22
14. Using the Display in Flat or Tilted Orientation	22
15. Using the Touch Screen.....	23
16. Using the Remote Control.....	24
16.1 Locking/Unlocking the OSD Menus	27
17. Basic Remote Functions	28
17.1 Turning the Display On	28
17.2 Turning the Display Off	28

17.3	Adjusting the Volume	28
17.4	Selecting the Input Source	28
17.5	Navigating Through the Menus.....	28
18.	Input Menu.....	29
19.	Picture Menu	30
19.1	Picture Menu – Color Control Submenu.....	32
20.	Audio Menu	33
21.	OSD Settings Menu.....	34
22.	Setup Menu	36
23.	Advanced Setup Menu.....	40
24.	Communication Menu	42
25.	Information Menu	48
26.	OSD Android Settings Menu.....	49
26.1	Android Main Menu	49
26.2	Apps.....	50
26.3	Files	51
27.	Media Player.....	51
27.1	Supported Media Formats	51
27.2	Main Menu.....	53
	External Control	58
	Signal Compatibility	59
	Color Subsampling Support	61
	Specifications	62
	Dimensions	64
	PS5074K	64
	PS5074KT	65
	PS5574K	66
	PS5574KT	67
	PS6574K	68
	PS6574KT	69
	Troubleshooting	70
	Accessing the Planar Technical Support Website	71
	Index	72

Introduction

The Planar® PS Series 4K line of TAA-compliant large format LCD displays is designed for digital signage applications. From static content viewing to content interaction, Planar PS Series 4K displays have you covered for a variety of retail, corporate or museum applications.

Available in 50", 55" and 65", the models feature narrow, logo-free bezels, slim profiles and 500-nit range brightness, delivering sleek looks and beautiful image quality. With an embedded Android® operating system, each model is capable of supporting cloud-based digital signage applications. With embedded WiFi, there's no need to physically connect the display to a network, so it can be installed wherever needed. For interactive content, multi-touch models are also available.

Each Planar PS Series 4K display is excellent for 24x7 operation and supports either landscape or portrait oriented mounting. Planar PS Series 4K displays deliver vibrant ultra-high definition images and messages that captivate the attention of any audience.

Caution: This manual is intended for use by qualified service persons and end users with experience installing LCD displays.

1. Safety Information

Before using the Planar PS Series 4K, please read this manual thoroughly to help protect against damage to property, and to ensure personnel safety.

- Be sure to observe the following instructions.
- For your safety, be sure to observe ALL the warnings detailed in this manual.
- For installation or adjustment, please follow this manual's instructions, and refer all servicing to qualified service personnel.

2. Safety Precautions

- **If water is spilled or objects are dropped inside the display, remove the power plug from the outlet immediately.** Failure to do so may result in fire or electrical shock. Contact your dealer for inspection.
- **If the display is dropped or the chassis is damaged, remove the power plug from the outlet immediately.** Failure to do so may result in fire or electrical shock. Contact your dealer for inspection.

WARNING! Wall mounts must be secure.

- **If the display is hung on a wall, the wall must be strong enough to hold it.** Simply mounting it to wallboard or wall paneling won't be adequate or safe.

Caution: The screen could be damaged by heavy pressure.

- **Slight pressure on the LCD will cause distortion of the image.** Heavier pressure will cause permanent damage. Displays should be mounted where viewers cannot touch the screen or insert small objects in the openings that will create hazards by contacting bare conductive parts.

Caution: The front polarizer is soft and subject to scratches from sharp objects.

- **The polarizer is a thin sheet of film laminated to the outside layer of glass on the LCD screen.** Take care when handling items near the screen.
- **If the power cord or plug is damaged or becomes hot, turn off the main power switch of the display. Make sure the power plug has cooled down and remove the power plug from the outlet.** If the display is still used in this condition, it may cause a fire or an electrical shock. Contact your dealer for a replacement.

2.1 Important Safety Instructions:

1. Read these instructions.
2. Keep these instructions.
3. Heed all warnings.
4. Follow all instructions.
5. Do not use the display near water.
6. Clean the LCD screens with an LCD screen cleaner or LCD wipes.
7. Do not install near any heat sources such as radiators, heat registers, stoves or other apparatus (including amplifiers) that produce heat.
8. Do not defeat the safety purpose of the polarized or grounding type plug. A polarized plug has two blades with one wider than the other. A grounding type plug has two blades and a third grounding prong. The wide blade or the third prong is provided for your safety. When the provided plug does not fit into your outlet, consult an electrician for the replacement of the obsolete outlet.
9. Protect the power cord from being walked on or pinched, particularly at plugs, convenience receptacles and the point where they exit from any Planar large format LCD display.
10. Only use the attachments/accessories specified by the manufacturer.
11. Unplug all displays during lightning storms or when unused for long periods of time.
12. In instances where a power surge has occurred and a display no longer has an image, the display power will need to be reset.
13. You must follow all National Electrical Code regulations. In addition, be aware of local codes and ordinances when installing your system.
14. Refer all servicing to qualified service personnel. Servicing is required when any of the displays have been damaged in any way, such as the AC power cord or plug is damaged, liquid has been spilled or objects have fallen into a product, the products have been exposed to rain or moisture, do not operate normally or have been dropped.
15. Keep the packing material in case the equipment should ever need to be shipped.
16. Wall mounts must be secure. The wall must be strong enough to hold displays brackets, cables and accessories. Seismic engineers should be consulted in areas prone to earthquakes.
17. Slight pressure on the LCD will cause distortion of the image. Heavier pressure will cause permanent damage. Displays should be mounted where viewers cannot touch the screen or insert small objects in the openings that will create hazards by contacting bare conductive parts.
18. The front polarizer is soft and subject to scratches from sharp objects. The polarizer is a thin sheet of film laminated to the outside layer of glass on the LCD screen. Take care when handling items near the screen.
19. **Caution:** There is a risk of explosion if the battery is replaced with incorrect type. Dispose of used batteries according to local regulations.

3. Recommended Usage

In order to get the most out of your LCD, use the following recommended guidelines to optimize the display.

3.1 Burn-In Versus Temporary Image Retention

Burn-in causes the screen to retain an image essentially forever, with little or no way to correct the problem. Under normal use, an LCD will not experience burn-in, as plasma displays do, nor will it retain images in any way.

Normal use of an LCD is defined as displaying continuously changing video patterns or images. However, LCDs can experience *temporary* image retention when recommended usage guidelines are not followed.

What is Temporary Image Retention?

Temporary image retention (TIR) can occur when a static image is displayed continuously for extended periods of time (12 hours or longer). An electrical charge differential may build up between the electrodes of the liquid crystal, which causes a negative-color video image (color-inverted and brightness-inverted version of the previous image) to be retained when a new image is displayed. This behavior is true for any LCD device from any LCD manufacturer.

TIR is not covered under warranty. See standard warranty terms and conditions for details. Here are some guidelines to help you avoid TIR:

- Use the LCD to show a screen saver, moving images or still pictures that change regularly. When using high-contrast images, reposition the images frequently.
- Turn off the LCD when it is not in use. To use your source computer's Power Options Properties, set up your computer to turn off the display when not in use.

3.2 Warranty Coverage

The following models are warranted for **24 x 7** usage:

- 50": PS5074K, PS5074K-N, PS5074KT, PS5074KT-N
- 55": PS5574K, PS5574K-N, PS5574KT, PS5574KT-N
- 65": PS6574K, PS6574K-N, PS6574KT, PS6574KT-N

Planar recommends turning off the power for **4 hours per day** for optimal performance.

For complete warranty details, please visit www.planar.com/warranty.

3.3 Important Waste Disposal Information

Please recycle or dispose of all electronic waste in accordance with local, state, and federal laws. Additional resources can be found online at <http://www.planar.com/about/green/>.

The crossed-out wheelee bin symbol is to notify consumers in areas subject to Waste Electrical and Electronic Equipment (WEEE) Directive 2012/19/EU that the product was placed on the market after August 13, 2005 and must not be disposed of with other waste. Separate collection and recycling of electronic waste at the time of disposal ensures that it is recycled in a manner that minimizes impacts to human health and the environment. For more information about the proper disposal of electronic waste, please contact your local authority, your household waste disposal service, or the seller from whom you purchased the product.



3.4 Normal Usage Guidelines

Normal use of the LCD is defined as operating in the open air to prevent heat buildup, and without direct or indirect heat sources such as lighting fixtures, heating ducts, or direct sunlight that can cause the modules to experience high operating temperatures. For all modules, do not block fans or ventilation openings. If the LCD module will be installed in a recessed area with an LCD surround or enclosure, ensure adequate openings are applied for proper air flow and ventilation.

At 3000 meters or below, the maximum ambient operating temperature for the LCD module cannot be above 40° C nor below the minimum ambient operating temperature of 0° C. If one of these conditions exists, it is up to the installer to ensure that module placement is changed, thermal shielding is provided and/or additional ventilation is provided to keep the display within its nominal operating parameters.

Cooling Requirements

For optimal performance, active cooling by the installer should be planned for when the ambient temperature at the top of the wall is predicted to be above the specified ambient temperature for the panel. Cooling may be done behind the displays and depending on the wall configuration.

4. VESA Mounts, General Description

VESA mounts are used to secure the Planar PS Series 4K Display. The display can be installed using a variety of VESA mounts available through Planar. If you do not have a VESA mount, and would like to purchase one, contact Planar.

If you purchased a VESA mount, you should have received a separate box with mounting supplies and an installation manual. Follow these instructions carefully.

Caution: Shorter screws will result in insufficient mounting strength and longer screws could puncture parts inside the display. The device may fall, causing serious personal injury or death. To prevent injury, this device must be securely attached to the wall in accordance with the installation instructions supplied with the mount. The mount must be secured to the PS Series 4K display using the four M6x1.0 VESA mounting locations, and 5mm - 10mm thread engagement is required for secure mounting. Select the correct screw/spacer combination for the mount.

- Prior to installation, make sure you know where all of the mounting points are located.
- Follow all safety precautions outlined in the VESA Installation manual.
- Verify the parts received with the list shown in the VESA Installation manual.

5. Cleaning the Display





If dust collects on the power plug, remove the plug from the outlet and clean off the dust. Dust build-up may cause a fire.

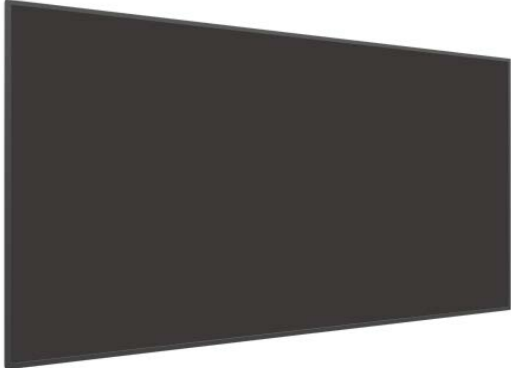

Remove the power plug before cleaning. Failure to do so may result in electrical shock or damage.

Keep the following points in mind when cleaning the surface of the display:

- When the surface of the display becomes dirty, wipe the surface lightly with a soft clean cloth.
- If the surface requires additional cleaning, use LCD screen cleaner or LCD wipes, which are available at most electronics stores.
- Do not let cleaner seep into the display, as it may cause electrical shock or damage.

Package Contents

Part	Description	Number	Picture
LCD Display	One per box.	1	
HDMI Cable	HDMI cable.	1	
AC Power Cord (US)	Power cord (US)	1	
AC Power Cord (EU)	Power cord (EU)	1	
IR Extender Cable	Receive signals from the remote control.	1	

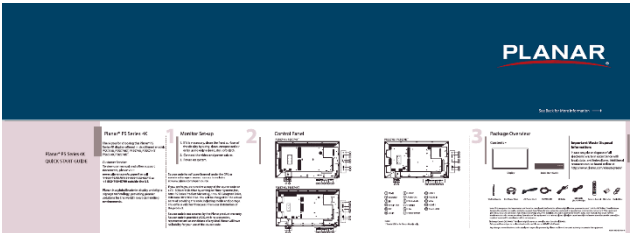
Part	Description	Number	Picture
USB Cable	Connects to a PC for touch functionality (touch models only).	1	
Remote Control	Used to control the display (AAA batteries included)	1	
Cable Clips	Used to clamp and organize the cables.	2	
Wi-Fi Antenna	2.4G 2dBi Dipole Antenna	1	
Quick Start Guide	Quick start guide.	1	

6. Installing the Cable Clips

Use the cable clips included in the Accessory Kit to assist with cable management. These clips snap into place in the locations shown in the image below.

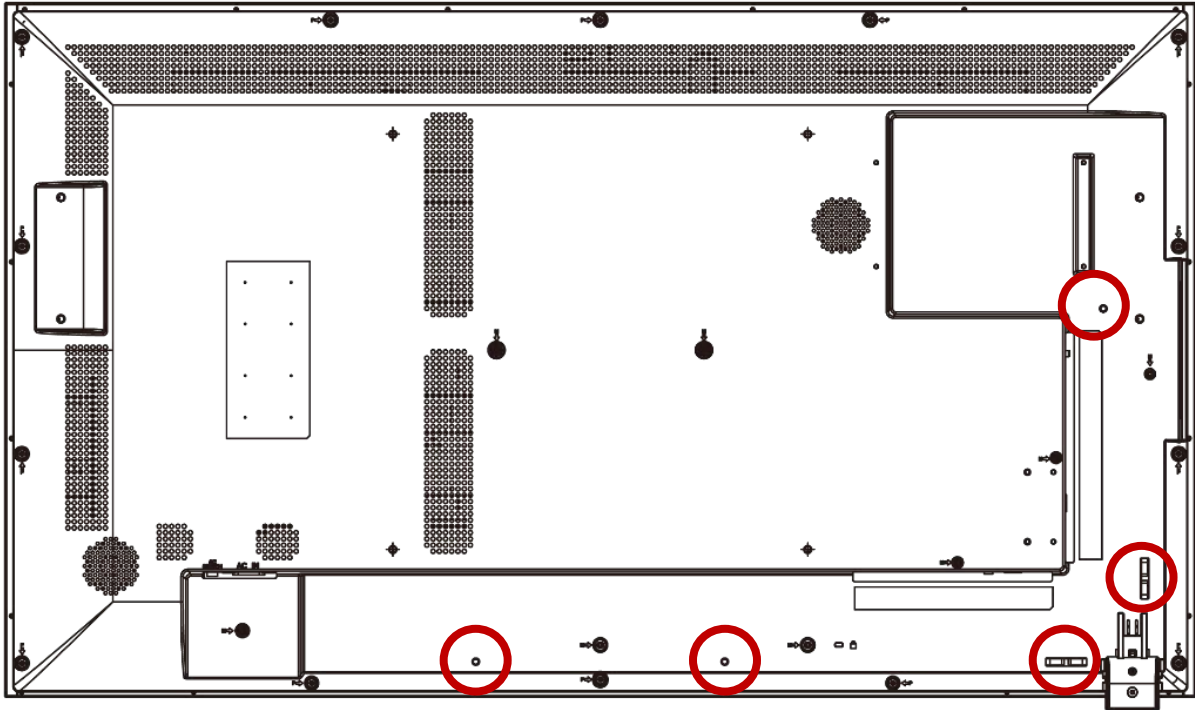

7. Standard Inputs

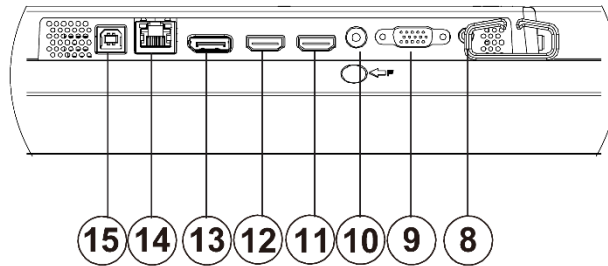
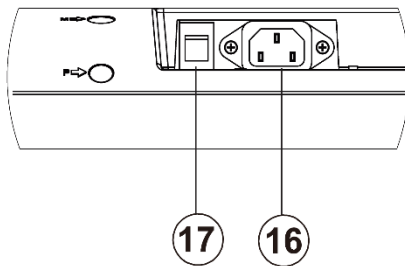
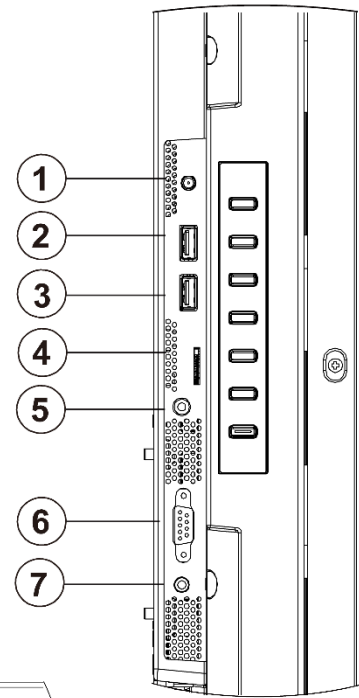
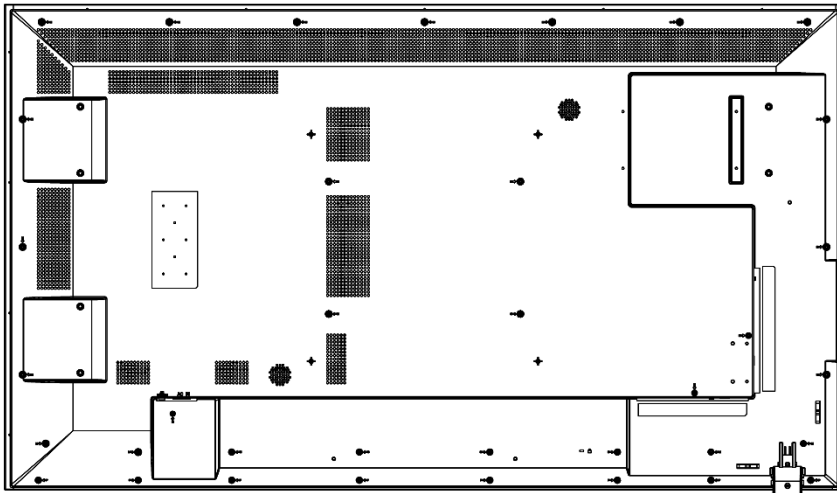

- | | |
|---------------|----------------------------|
| ① Wi-Fi | ⑪ HDMI 2 |
| ② USB 2 / | ⑫ HDMI 1 |
| ③ USB 1 | ⑬ DP |
| ④ microSD | ⑭ LAN |
| ⑤ Audio Out | ⑮ Touch USB (Touch models) |
| ⑥ RS232 In | ⑯ AC In |
| ⑦ IR | ⑰ Power Switch |
| ⑧ PC Audio In | |
| ⑨ VGA | |
| ⑩ SPDIF Out | |

Installing the Display

This section explains how to install your display. We suggest that you read the entire section before you attempt to install the unit.

8. Before You Begin

Make sure you have all the items in these lists before you begin unpacking and installing your display(s).

8.1 Tools/Equipment List

Depending on your installation, you may need one or more of the following items:

- String/string level
- Digital/laser level
- Ladders/lift
- Back brace
- Stud finder (if hanging display on a wall)
- Planar PS 4K Series handle accessory (sold separately. Part Number: 998-1876-xx)

8.2 Other Things You May Need

- LCD screen cleaner or LCD wipes - available at most electronics stores
- At least two very strong people to help lift unit into place

8.3 Plan Your Installation

You should have a detailed plan of how the units are to be configured. The plan should include calculations for the following:

- Power maximums reference below by display size:
 - PS5074K(T): 8 units max per 20A circuit for 115V operation
 - PS5574K(T): 6 units max per 20A circuit for 115V operation
 - PS6574K(T): 8 units max per 20A circuit for 115V operation
- Cable runs
- Ventilation and cooling requirements
- If hanging display on a wall, location of studs in the wall

8.4 Prepare Your Installation Location

Prepare the area where you will install the unit. If custom enclosures are part of the installation, they must be fully designed to accommodate the installation of the displays, the installed units, and ventilation and cooling requirements.

If your installation includes a lot of construction or dust, it is **highly recommended** that you clean all of the screens after the wall installation and configuration are complete.

8.5 Cable Length Recommendations

Cable length performance may vary between different cables and sources. The recommended maximum cable lengths are as follows:

HDMI

- 4K @ 50/60Hz: 5m (15 ft) maximum
- 4K @ 24/25/30Hz: 15m (50 ft) maximum
- 1080p @ 60Hz and lower resolutions: 20m (65 ft) maximum

DisplayPort

- 8m (25 ft) maximum

Operating the Display

9. OSD Keypad

The OSD keypad is located on the left side of the display.

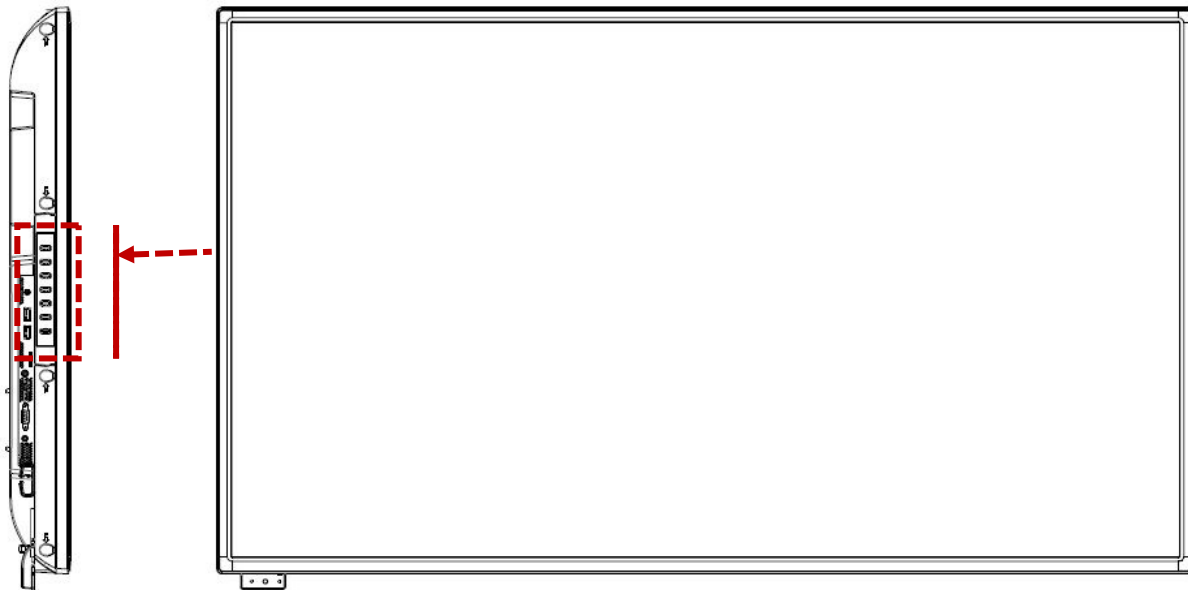

OSD Keypad Buttons



Key	Descriptions
POWER	Power on / Power off
▲	Menu Down
▼	Menu Up
-	Menu Left / Decrease value / Volume -
+	Menu Right / Increase value / Volume +
SOURCE	Source Selection
MENU	Menu Open / Close

10. Remote Control Receiver

The remote control receiver is located on a module on the rear side of the display. Pull down the module to provide front facing sensor visibility. See the drawing below for reference. Use the IR extender cable to improve remote control distance and angular performance.

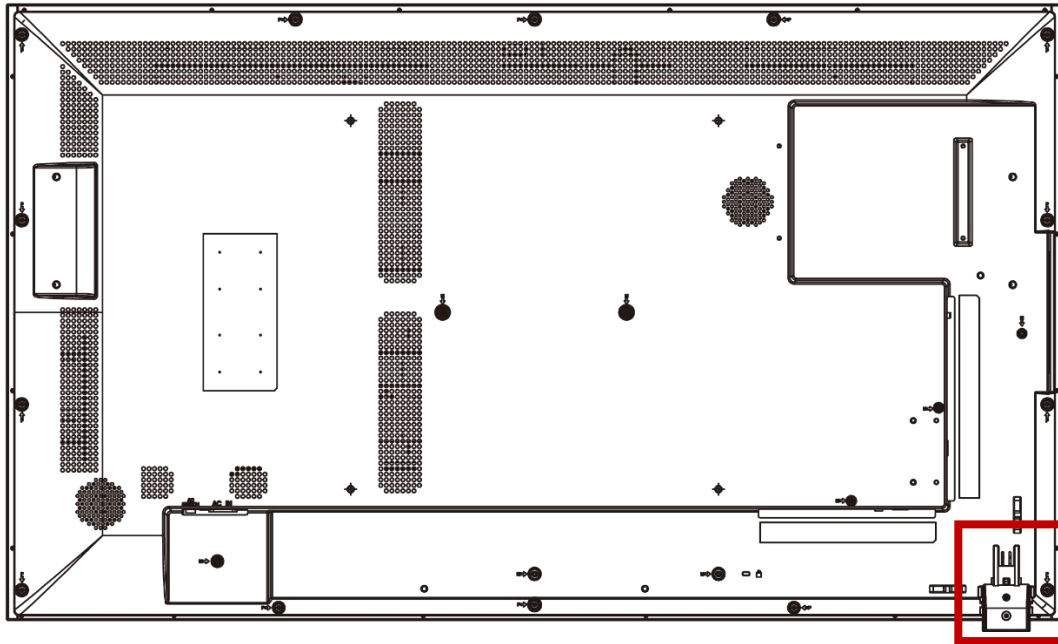

11. Installing IR Extender

The position of the IR extender will affect the reception of the IR signal. To ensure the best IR reception, P1 and P2, the two positions marked in the figure below, are recommended for installing the IR extender.

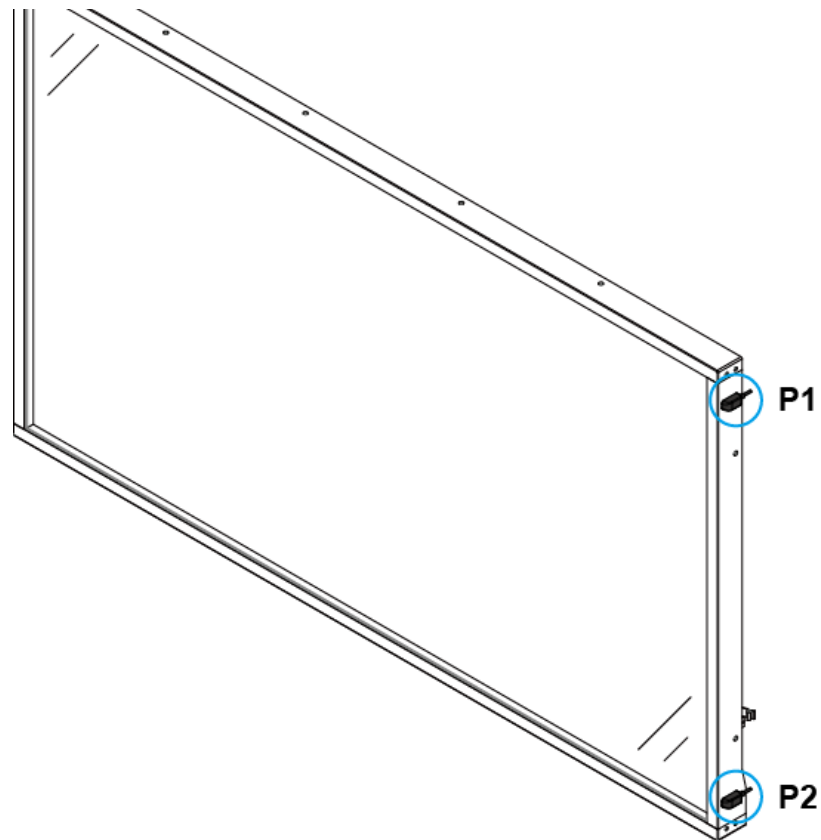

12. LED Indicators

The LED indicator light is located at the bottom left side of the display. The following table explains what the different colors and blink patterns mean.

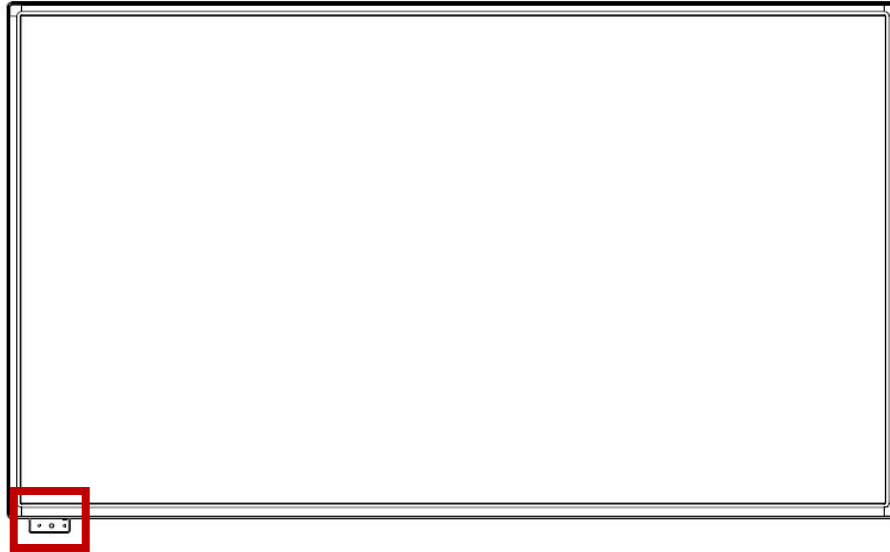

LED On

Power Status	Condition
Green	Power on; Normal operation
Red	Power save mode
	Power off
Off	AC off

13. Using the Display in Portrait Mode

When using the display in the portrait position and looking at the rear of the display, it should be rotated according to the arrow stickers on the back of the display. This will allow for proper ventilation. Then select the OSD rotation of landscape or portrait on the OSD menu (MAIN MENU > OSD SETTINGS > OSD ROTATION).

For reference, the following list indicates the rotation direction of each display model when placed in portrait mode when viewed from the front:

- PS5074K(-T): Counterclockwise
- PS5574K(-T): Counterclockwise
- PS6574K(-T): Counterclockwise

Caution: Improper ventilation may shorten the life of the display

14. Using the Display in Flat or Tilted Orientation

The display is not recommended for use in flat orientation for tabletop, floor, or ceiling installations. LCD panels of this size are at risk of panel deflection, which can cause cosmetic sagging, brightness uniformity issues, and a shortened life span. Installations where the display is tilted downward or upward at an angle may also be prone to these issues and are not recommended.

Note: Failure to follow these instructions will void the warranty.

15. Using the Touch Screen

You can use the touch screen to control your Windows, Mac or Linux operating system. The Planar PS Series 4K is HID compliant, delivering up to 20 points of touch on both Windows and Linux without a driver. Single touch only is supported for Mac operating systems. To achieve more than single touch Mac support, drivers will need to be installed, which can be found on <http://www.planar.com/support/>.

Note: Ensure that you have installed the USB cable on the display to a computer.

Note: The menu system is connected internally to the touch system and can be controlled in this manner. This behavior is configurable via the Touch Control setting.

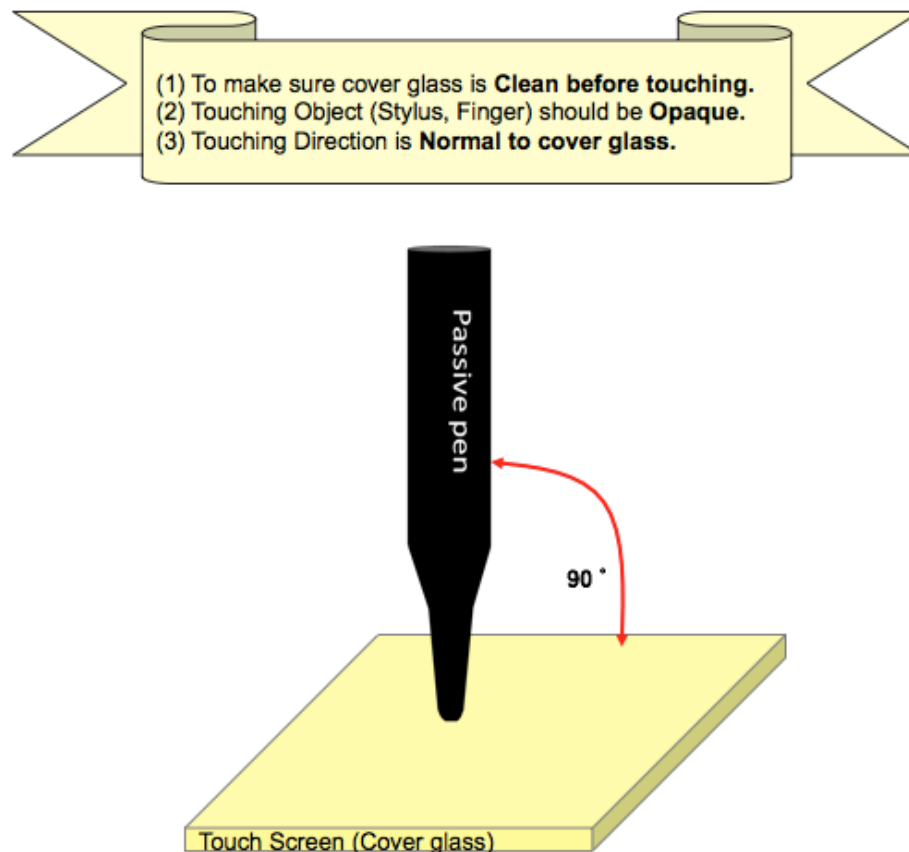

Note: When using the passive stylus on the touch screen, make sure to follow the instructions shown in the picture below:

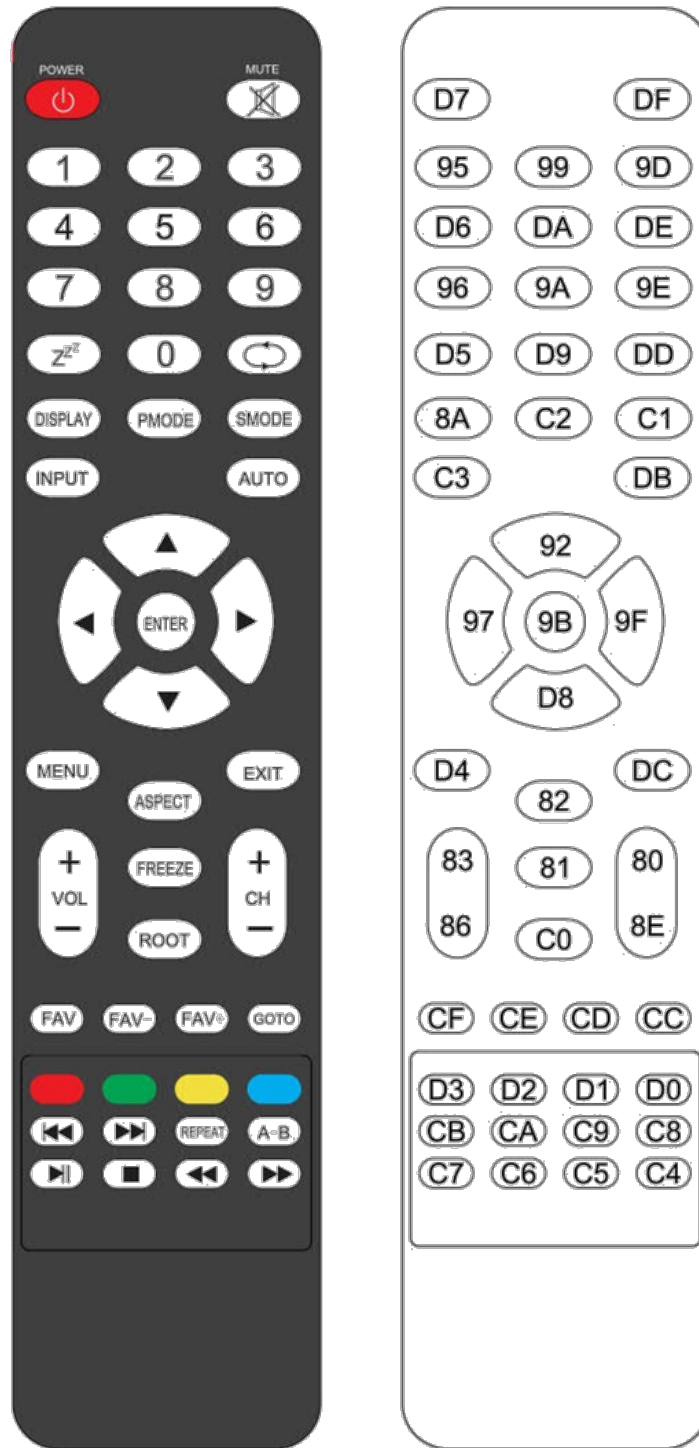

16. Using the Remote Control

Below is a picture of the remote control and its corresponding Hex codes.



IR Remote Key Codes				
Key Name	Address	Data	NEC Data	Description
POWER	2295	215	0x08F7D728	Power toggle
MUTE	2295	223	0x08F7DF20	Audio mute
1	2295	149	0x08F7956A	Number 1
2	2295	153	0x08F79966	Number 2
3	2295	157	0x08F79D62	Number 3
4	2295	214	0x08F7D629	Number 4
5	2295	218	0x08F7DA25	Number 5
6	2295	222	0x08F7DE21	Number 6
7	2295	150	0x08F79669	Number 7
8	2295	154	0x08F79A65	Number 8
9	2295	158	0x08F79E61	Number 9
0	2295	217	0x08F7D926	Number 0
ZZZ	2295	213	0x08F7D52A	Sleep mode toggle
	2295	221	0x08F7DD22	Not used
DISPLAY	2295	138	0x08F78A75	Source Information
PMODE	2295	194	0x08F7C23D	Picture Mode
SMODE	2295	193	0x08F7C13E	Sound Mode
INPUT	2295	195	0x08F7C33C	Source selection
AUTO	2295	219	0x08F7DB24	Auto adjust on VGA
UP	2295	146	0x08F7926D	Navigate up
LEFT	2295	151	0x08F79768	Navigate left
ENTER	2295	155	0x08F79B64	Selects the current menu item
RIGHT	2295	159	0x08F79F60	Navigate right
DOWN	2295	216	0x08F7D827	Navigate down
MENU	2295	212	0x08F7D42B	Opens the menu
EXIT	2295	220	0x08F7DC23	Exits the menu
VOL +	2295	131	0x08F7837C	Volume increase
VOL -	2295	134	0x08F78679	Volume decrease
ASPECT	2295	130	0x08F7827D	Aspect ratio toggle
FREEZE	2295	129	0x08F7817E	Freezes the current input source
ROOT	2295	192	0x08F7C03F	Return to Android
CH +	2295	128	0x08F7807F	Not used
CH -	2295	142	0x08F78E71	Not used
FAV	2295	207	0x08F7CF30	Not used
FAV -	2295	206	0x08F7CE31	Not used
FAV +	2295	205	0x08F7CD32	Not used
GOTO	2295	204	0x08F7CC33	Not used
[Red]	2295	211	0x08F7D32C	Red button (function varies)
[Green]	2295	210	0x08F7D22D	Green button (function varies)
[Yellow]	2295	209	0x08F7D12E	Yellow button (function varies)
[Blue]	2295	208	0x08F7D02F	Blue button (function varies)
	2295	203	0x08F7CB34	Rewind content to the beginning
	2295	202	0x08F7CA35	Fast forward content to the end
REPEAT	2295	201	0x08F7C936	Repeat content
A-B	2295	200	0x08F7C837	Not used

IR Remote Key Codes				
Key Name	Address	Data	NEC Data	Description
▶	2295	199	0x08F7C738	Play or pause content
■	2295	198	0x08F7C639	Stop content
◀◀	2295	197	0x08F7C53A	Rewind content
▶▶	2295	196	0x08F7C43B	Fast forward content

16.1 Locking/Unlocking the OSD Menus

You can lock or unlock the OSD menus by pressing a series of key commands on the remote control. To lock the menu, press the following keys on the remote in the order listed: ENTER, ENTER, EXIT, EXIT, ENTER and EXIT. To unlock it, simply follow the same sequence.

Depending on whether you locked or unlocked the menu, you will see one of the following messages on the screen.

A gray rectangular box containing the text "Key Unlocked".

Key Unlocked

A gray rectangular box containing the text "Key Locked".

Key Locked

17. Basic Remote Functions

17.1 Turning the Display On

1. Insert the power cord into the display and into the power outlet.
2. Ensure the AC switch is set to “—”.
3. Press the power button on the remote or keypad.

17.2 Turning the Display Off

With the power on, press the power button on the remote or keypad to put the LCD panel in a standby mode. To turn off power completely, turn the AC switch to “O” or disconnect the AC power cord from the power outlet.

Note: If there is no signal for a certain period of time, the LCD panel will automatically go into standby mode.

17.3 Adjusting the Volume

1. Using the remote, press the VOL- or VOL+ to increase or decrease the volume.
2. Pressing the MUTE button temporarily turns off all sound. To restore the sound, press the MUTE button again.

Note: The analog audio out is variable. S/PDIF is fixed.

17.4 Selecting the Input Source

Press the INPUT button on the remote or press the Source button on the keypad. Use the arrow buttons (▲▼) to select one of the following input sources: DP, HDMI1, HDMI2, VGA, Android, and press ENTER.

Note: When the display cannot find a source, a “No signal” message will appear.

17.5 Navigating Through the Menus

1. With the power on, press MENU. The main menu appears.
2. Within the menu, use ▲, ▼, ◀, ▶, and ENTER to navigate through the menus and adjust options.
3. Press MENU to return to the previous menu. To exit the menu system, press EXIT.

18. Input Menu

Below are the menus used for selecting the input sources for all models:

Input	Main Input	HDMI1
Picture	Auto Scan	Off
Audio	Aspect Ratio	Full Screen
OSD Settings	Power On Input	Last Input
Setup		
Adv. Setup		
Communications		
Information		

Main Input

- Select the input source
- **Options:** VGA, HDMI1, HDMI2, DP, Android, Web Browser, Android APP
- **Default:** HDMI1

Auto Scan

- Select to scan inputs in order until a valid signal is detected. Continue scanning when the signal on the selected input is lost.
- **Options:** On, Off
- **Default:** Off

Aspect Ratio







- Adjust the aspect ratio of the screen.
- **Options:** Full Screen, Letterbox, 4:3, Native
- **Default:** Full Screen

Power On Input

- Select the input source to be displayed at power up. Selecting Last Input will cause the last selected input to be used as the power up source.
- **Options:** Last Input, VGA, HDMI1, HDMI2, DP, Android, Web Browser, Android APP
- **Default:** Last Input

19. Picture Menu

This menu is used for making common image adjustments.

Input	Scheme	Standard
Picture	Contrast	 50
Audio	Brightness	 50
OSD Settings	Sharpness	 50
Setup	Hue	 50
Advanced Setup	Saturation	 50
Communications	Backlight	 80
Information	Gamma	 2.2
	Color Temperature	9300K
	Color Control	>>>
	Overscan	 0
	HDMI Color Range	Auto

Scheme

- Press to select one of the following:
- **Options:** Standard, Soft, User, Vivid, Natural, Sports
- **Default:** Standard

Contrast

- Increase or decrease the contrast of picture. Press ◀ or ▶ to select the desired level.
- **Range:** 0~100
- **Default:** 50

Brightness

- Increase or decrease the brightness of picture. Press ◀ or ▶ to select the desired level.
- **Range:** 0~100
- **Default:** 50

Sharpness

- Adjust the definition of picture. Press ◀ or ▶ to select the desired level.
- **Range:** 0~100
- **Default:** 50

Hue

- Increase or decrease the green hue. Press ◀ or ▶ to select the desired level.
- **Range:** 0~100
- **Default:** 50

Saturation

- Adjust the brilliance and brightness. Press ◀ or ▶ to select the desired level.

- **Range:** 0~100
- **Default:** 50

Backlight

- Increase or decrease the intensity of the LCD backlight. Press ◀ or ▶ to select the desired level.
- **Range:** 15~100
- **Default:** 80

Gamma

- Select gamma
- **Options:** Off, 1.85, 1.9, 1.95, 2.0, 2.05, 2.10, 2.15, 2.2, 2.25, 2.3, 2.35, 2.4, 2.45, 2.5, 2.55, 2.6
- **Default:** 2.2

Color Temperature

- Select color temperature
- **Options:** User, 3200K, 5000K, 6500K, 7500K, 9300K
- **Default:** 9300K

Color Control

- Adjust color calibration. See [page 32](#) for more details.

Overscan

- Adjust the zoom (overscan) of the image
- **Options:** 0~10
- **Default:** 0

HDMI Color Range

- Select RGB range for HDMI and DisplayPort sources
- **Options:** Auto, 0~255, 16~235
- **Default:** Auto

19.1 Picture Menu – Color Control Submenu

Note: Certain settings are only available in later versions of firmware. Please upgrade to the latest firmware version if unsupported settings are encountered.

Color Control		
Red Gain		128
Green Gain		128
Blue Gain		128
Red Offset		128
Green Offset		128
Blue Offset		128

Red Gain

- Adjust the amount of red in bright content
- **Range:** 0~256
- **Default:** 128

Green Gain

- Adjust the amount of green in bright content
- **Range:** 0~256
- **Default:** 128

Blue Gain

- Adjust the amount of blue in bright content
- **Range:** 0~256
- **Default:** 128

Red Offset

- Adjust the amount of red in dark content
- **Range:** 0~256
- **Default:** 128

Green Offset

- Adjust the amount of green in dark content
- **Range:** 0~256
- **Default:** 128

Blue Offset

- Adjust the amount of blue in dark content
- **Range:** 0~256
- **Default:** 128

20. Audio Menu

This menu is used for adjusting audio settings.

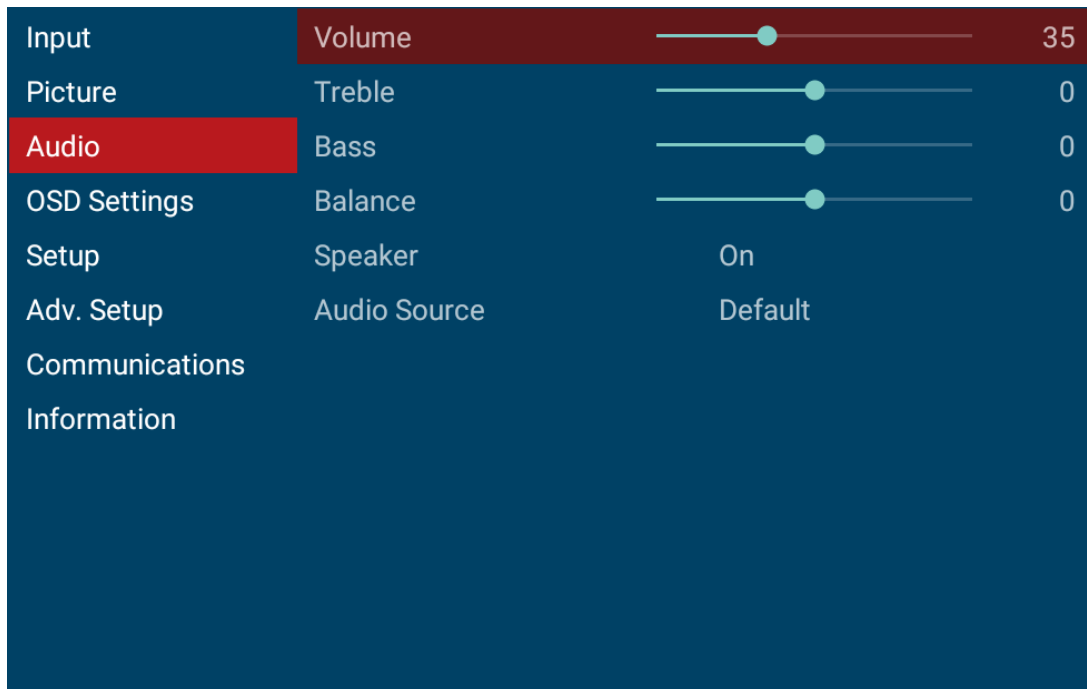

Volume

- Adjust the sound. Press ◀ or ▶ to select the desired level.
- **Range:** 0~100
- **Default:** 35

Treble

- Adjust the sound in high tones (treble). Press ◀ or ▶ to select the desired level.
- **Range:** -50~+50
- **Default:** 0

Bass

- Adjust the sound in low tones (bass). Press ◀ or ▶ to select the desired level.
- **Range:** -50~+50
- **Default:** 0

Balance

- Adjust the balance of the left and right speakers. Press ◀ or ▶ to select the desired level.
- **Range:** -50~+50
- **Default:** 0

Speaker



- Turn the speaker on or off
- **Options:** On, Off
- **Default:** On

Audio Source

- Select the audio source that is played through the display's internal speakers, audio out and digital audio out.
- **Options:** Default, Audio In
- **Default:** Default

21. OSD Settings Menu

This menu is used to make initial setup adjustments to the OSD (On-Screen Display) menu and other on-screen messages.

Input	OSD Horizontal		50
Picture	OSD Vertical		50
Audio	OSD Transparency		0
OSD Settings	OSD Timeout	30 seconds	
Setup	OSD Rotation	Landscape	
Advanced Setup	OSD Sound	On	
Communications	Language	English	
Information	Splash Screen	On	
	Message Box	On	
	Power LED	On	
	Navigation Bar	On	

OSD Horizontal

- Adjust the horizontal position of the OSD menu. Press ◀ or ▶ to select the desired level.
- Range: 0~100
- **Default:** 50

OSD Vertical

- Adjust the vertical position of the OSD menu. Press ◀ or ▶ to select the desired level.
- Range: 0~100
- **Default:** 50

OSD Transparency

- Submenu to adjust the transparency of the OSD menu. Press ◀ or ▶ to select the desired level.
- **Options:** 0~10
- **Default:** 0

OSD Timeout

- Submenu to adjust the time in seconds before the OSD menu disappears. Press ◀ or ▶ to select the desired level.
- **Options:** Off, 5 sec, 10 sec, 20 sec, 30 sec, 60 sec
- **Default:** 30 sec

OSD Rotation

- Rotate the OSD for use in either landscape or portrait orientation.
- **Options:** Landscape, Portrait
- **Default:** Landscape

OSD Sound

- Turn off the Android OSD sound effects
- **Options:** On, Off
- **Default:** On

Language

- Select the OSD language
- **Options:** English, Français, Deutsch, Español, 繁體中文, 简体中文, 日本語, Italiano, Português
- **Default:** English

Splash Screen

- Select whether a splash screen appears when the monitor is powered up
- **Options:** On, Off
- **Default:** On

Message Box

- Select whether a message box is displayed on screen
- **Options:** On, Off
- **Default:** On

Power LED

- Enable or disable the status LED
- **Options:** On, Off
- **Default:** On

Navigation Bar

- Select whether to display the Android navigation bar at startup and when swiping up from the bottom. Use the touch screen or a USB mouse to perform the swipe.
- **Options:** On, Off
- **Default:** On

22. Setup Menu



Auto Adjustment

- Force the display to reacquire and lock to the input signal (VGA source only). This is useful when the signal quality is marginal.
- **Note:** This feature does not continually reacquire the signal.

H Position

- Adjust the horizontal position of the image (VGA source only). Press ◀ or ▶ to select the desired level.
- **Range:** 0~100
- **Default:**50

V Position

- Adjust the vertical position of the image (VGA source only). Press ◀ or ▶ to select the desired level.
- **Range:** 0~100
- **Default:** 50

Phase

- Adjust the phase of the displayed signal (VGA source only). Press ◀ or ▶ to select the desired level.
- **Range:** 0~100

Clock

- Adjust the clock of the displayed signal (VGA source only). Press ◀ or ▶ to select the desired level.
- **Range:** 0~100

Date and Time

- This menu is used to set the internal clock of the display.

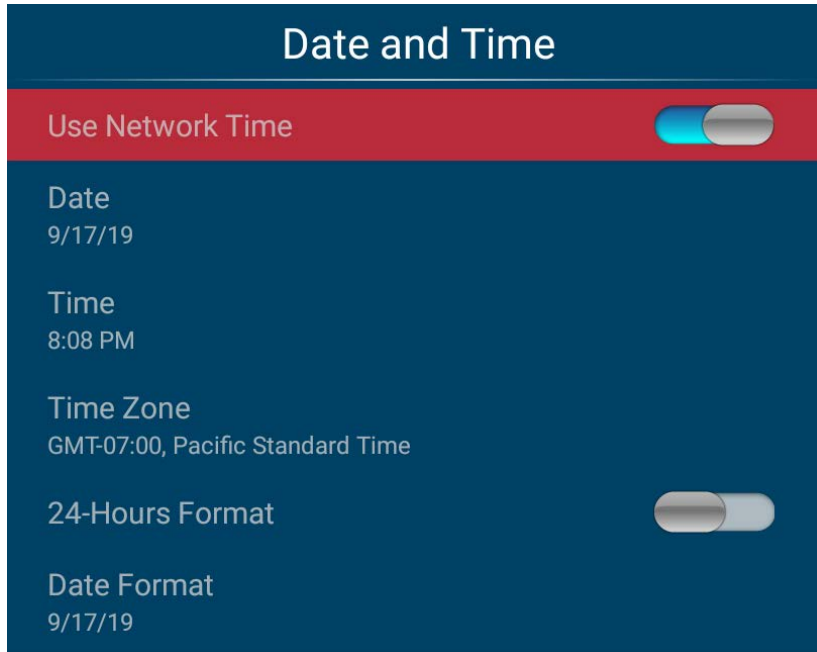

Use Network Time

- Automatically set the current date and time information from a network.
- **Options:** On, Off
- **Default:** On

Date

- Set the current date. Configurable when Use Network Time is turned off.

Time

- Set the current time. Configurable when Use Network Time is turned off.

Time Zone

- Select the current time zone.

24-Hours Format

- Change the time format to a 24-hour format.
- **Options:** On, Off
- **Default:** Off

Date Format

- Select the desired date format.
- **Options:** month/day/year, day/month/year, year/month/day

Schedule

- This menu is used to set power on and power off the display at preset times if desired. Up to three different schedules can be set.

Schedule			
Current Time	2019 / 09 / 17 20 : 08 Tuesday		
Timer Mode	User Mode		
Weekday	Enable	Power On	Power Off
Monday	<input type="checkbox"/>	00 : 00	00 : 00
Tuesday	<input type="checkbox"/>	00 : 00	00 : 00
Wednesday	<input type="checkbox"/>	00 : 00	00 : 00
Thursday	<input type="checkbox"/>	00 : 00	00 : 00
Friday	<input type="checkbox"/>	00 : 00	00 : 00
Saturday	<input type="checkbox"/>	00 : 00	00 : 00
Sunday	<input type="checkbox"/>	00 : 00	00 : 00

User Mode

- Select the power on/off time for each day of the week
- **Options:** Disable, Enable
- Use the arrow keys to specify the on and off times

Schedule			
Current Time	2019 / 09 / 17 20 : 08 Tuesday		
Timer Mode	Workdays		
Weekday	Enable	Power On	Power Off
Monday ~ Friday	<input type="checkbox"/>	00 : 00	00 : 00
Saturday	<input type="checkbox"/>	00 : 00	00 : 00
Sunday	<input type="checkbox"/>	00 : 00	00 : 00

Workdays

- Select the power on/off time for Monday–Friday, Saturday, and Sunday
- **Options:** Disable, Enable
- Use the arrow keys to specify the on and off times.

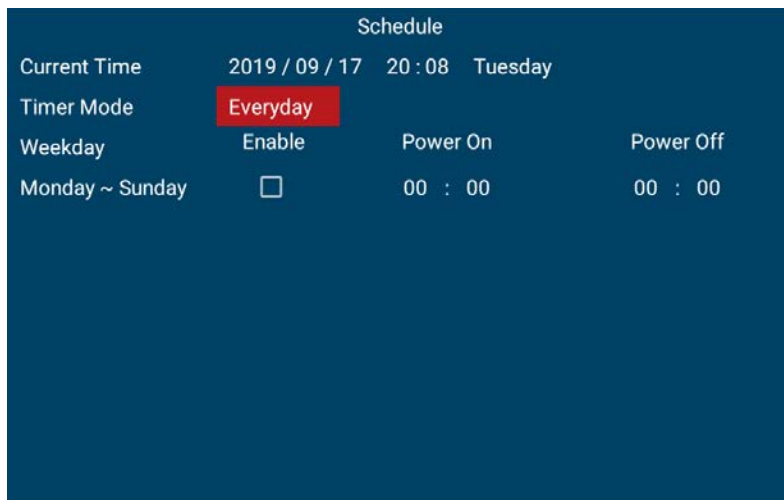

Everyday

- Select the power on/off time for Monday–Sunday
- **Options:** Disable, Enable
- Use the arrow keys to specify the on and off times.

23. Advanced Setup Menu

Input	Smart Light Control	Off
Picture	Pixel Orbit	Off
Audio	Noise Reduction	Off
OSD Settings	Power Saving Config	Standby Mode
Setup	EDID Setup	>>>
Advanced Setup	Touch Control	Auto
Communications	CEC Setup	>>>
Information	App Manager	>>>
	Factory Reset	
	Firmware Update (USB)	

Smart Light Control

- Enable dynamic contrast
- **Options:** On, Off
- **Default:** Off

Pixel Orbit

- Create slight frame motion to help avoid image retention
- **Options:** On, Off
- **Default:** Off

Noise Reduction

- Reduce random noise in video content
- **Options:** Off, Low, Medium, High, Auto
- **Default:** Off

Power Saving Config

- Select the behavior of the display when a signal is detected while in standby mode. Standby Mode will turn on the display when a signal is detected on the VGA or HDMI input. Wake on All will turn on the display when a signal is detected on any input.
- **Options:** Standby Mode, Networked Standby Mode, Wake on All, Always On
- **Default:** Standby Mode
- **Note:** For Standby Mode and Wake on All, the display will enter power saving mode if no signal is received for 5 minutes.
- **Note:** RS232 and LAN functionality will not work in standby mode if Standby Mode is selected. Use another Power Saving Config selection if RS232 or LAN support is needed.

EDID Setup

- Select EDID (Extended Display Identification Data) of the HDMI and DisplayPort inputs
- **Options:**
 - HDMI 1, HDMI2: HDMI 1.4, HDMI 2.0;
 - DP: 4K30, 4K60
- **Default:**
 - HDMI 1, HDMI2: HDMI 2.0;
 - DP: 4K60
- **Note:** HDMI 2.0 is the more modern standard and supports 3840x2160 @ 60Hz resolution. However, sometimes HDMI 1.4 is needed for compatibility with older devices.

Touch Control

- Select whether the touch screen controls an external PC via the Touch USB connector, or controls the display's menu system.
- **Options:** Auto, Internal, External
- **Default:** Auto

CEC Setup

- Control of a device and display panels over the HDMI port by using one remote control.
 - CEC Enable
 - Enable HDMI-CEC control
 - **Options:** On, Off
 - **Default:** Off
 - Auto Standby
 - Enable auto standby and make sure that CEC Enable is set to On first.
 - **Options:** On, Off
 - **Default:** Off

App Manager

- Shows all downloaded Android apps in the display, including information of app version and installed size.
- At the bottom appears the amount of total and free storage space.

Factory Reset

- Restore all settings to their default
- **Options:** No, Yes
- **Default:** No

Firmware Update (USB)

- Plug in the USB flash drive and select Yes to proceed with firmware update.
- **Options:** No, Yes
- **Default:** Yes

24. Communication Menu

This menu configures the display's RS-232 and Ethernet communication ports.

Input	Baud Rate	19200
Picture	LAN Configuration	>>>
Audio	Wi-Fi Configuration	>>>
OSD Settings	Hotspot Configuration	>>>
Setup	Email Configuration	>>>
Adv. Setup	SNMP Configuration	>>>
Communications	Control Over TCP	>>>
Information	Ethernet MAC	00:1f:b6:50:02:65
	Wi-Fi MAC	3c:33:00:f9:78:df

Baud rate

- Select the baud rate of the display's RS-232 port
- **Options:** 115200, 38400, 19200, 9600
- **Default:** 19200

LAN Configuration

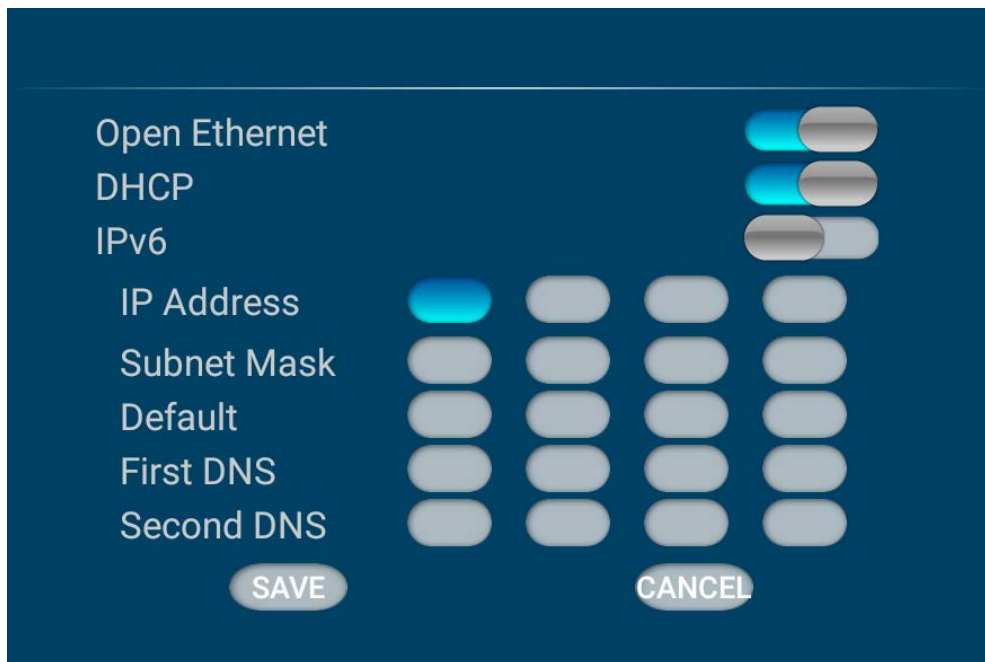

- Open Ethernet
 - Enable the display's built-in Ethernet port
 - **Options:** On, Off
 - **Default:** On
- DHCP
 - Enable dynamic IP mode
 - **Options:** On, Off
 - **Default:** On
- IPv6
 - Enable IPv6 support
 - **Options:** On, Off
 - **Default:** Off
- IP Address
 - Set IP address
 - **Options:** 255.255.255.255
 - **Default:** 0.0.0.0
- Subnet Mask
 - Set subnet mask
 - **Options:** 255.255.255.255
 - **Default:** 0.0.0.0
- Default
 - Set gateway address
 - **Options:** 255.255.255.255
 - **Default:** 0.0.0.0
- First DNS

- Set DNS address
- **Options:** 255.255.255.255
- **Default:** 0.0.0.0
- Second DNS
 - Set DNS address
 - **Options:** 255.255.255.255
 - **Default:** 0.0.0.0

WiFi Configuration

- Enable a WiFi connection
- **Options:** On, Off
- **Default:** On

Hotspot Configuration

- WiFi hotspot
 - Enable WiFi hotspot settings
 - **Options:** On, Off
 - **Default:** Off
- Config WiFi hotspot
 - Configure WiFi hotspot settings

Email Configuration

- This menu configures a Simple Mail Transfer Protocol (SMTP) server for sending status information from the display via e-mail.

Email Configuration	
SMTP Enable	On
Server	Gmail
E-mail	
Password	
SMTP Server	smtp.gmail.com
Security type	SSL
Port	465
Manager Email	

- SMTP Enable
 - Use this menu to enter the Simple Mail Transfer Protocol (SMTP) server settings. Ask your network administrator or ISP to provide the correct settings for the following fields.
 - **Options:** On, Off

- **Default:** On
- Server
 - Select whether a Gmail server or another server will be used.
 - **Options:** Gmail, Other
 - **Default:** Gmail
 - **Note:** Using Gmail requires enabling support for less secure apps in your Gmail account. Consult your Gmail settings for more information.
- E-mail
 - Specify the email account that will send messages.
- Password
 - The password for the e-mail account.
- SMTP Server
 - The SMTP server name or address associated with the e-mail account.
 - **Default:** smtp.gmail.com
- Security Type
 - The type of security for the SMTP connection.
 - **Options:** None, SSL, TLS, STARTTLS
 - **Default:** SSL
- Port
 - The port for the SMTP connection. Typically, this is port 465.
- Manager Email
 - Specify the email address that will receive notifications.

SNMP Configuration

- Configure the Simple Network Management Protocol (SNMP) settings

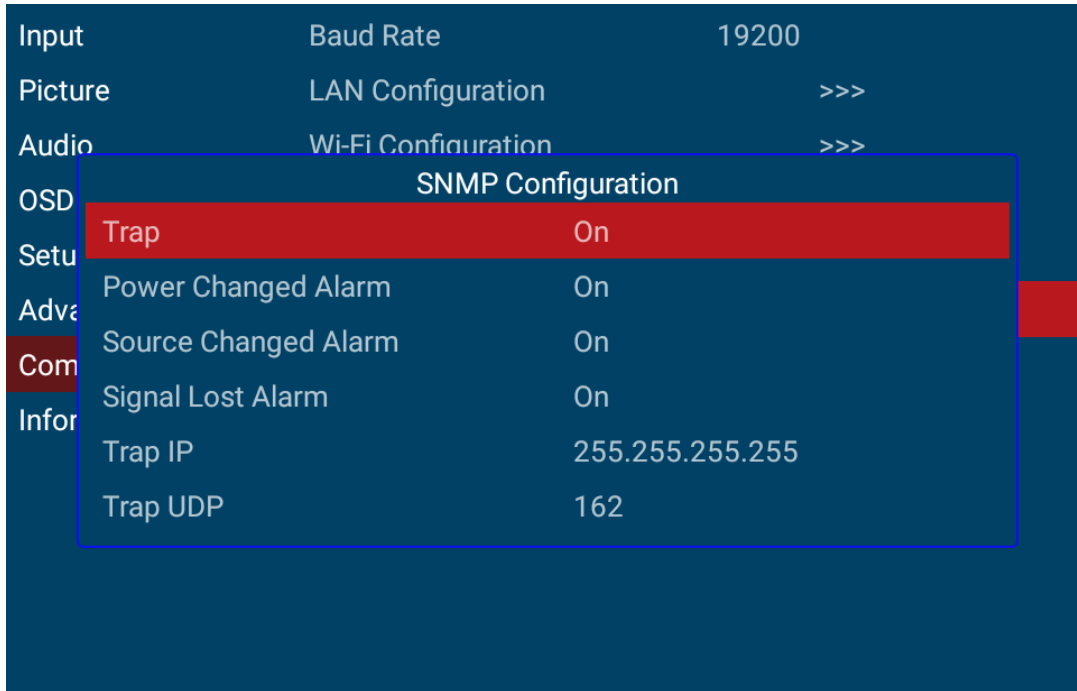

- Trap
 - Enable and configure the Trap communication
 - **Options:** On, Off
 - **Default:**
- Power Changed Alarm
 - Enable the power changed alarm
 - **Options:** On, Off
 - **Default:** On
- Source Changed Alarm
 - Enable the source changed alarm
 - **Options:** On, Off
 - **Default:** On
- Signal Lost Alarm
 - Enable the signal changed alarm
 - **Options:** On, Off
 - **Default:** On
- Trap IP
 - Specify the destination IP address for the SNMP trap receiver
 - **Default:** 255.255.255.255
- Trap UDP
 - Specify the UDP port for SNMP trap receiver connections
 - **Default:** 162

Control Over TCP

- Enable and configure the TCP communication over the LAN and WiFi connections
- **Settings:**
 - Enable Control Over TCP
 - Enable TCP communication over the network
 - **Options:** On, Off
 - **Default:** On
 - TCP Port
 - Select the TCP port for network connections
 - **Default:** 23

Ethernet MAC

- Show the MAC address of the display

WiFi MAC

- Show the WiFi address of the display

25. Information Menu

This read-only menu provides information on the active sources and the latest firmware version.

Input	Input Source	HDMI1
Picture		No Signal
Audio		
OSD Settings	Default APP	Hypersign
Setup	Android	6.0(API:23)
Advanced Setup	Wi-Fi IP	
Communications	LAN IP	
Information	Model	None
	Version	v1.10
	Serial No.	None

26. Android Settings Menu

26.1 Android Main Menu

To access the Android menu, open the Input menu and select Android.

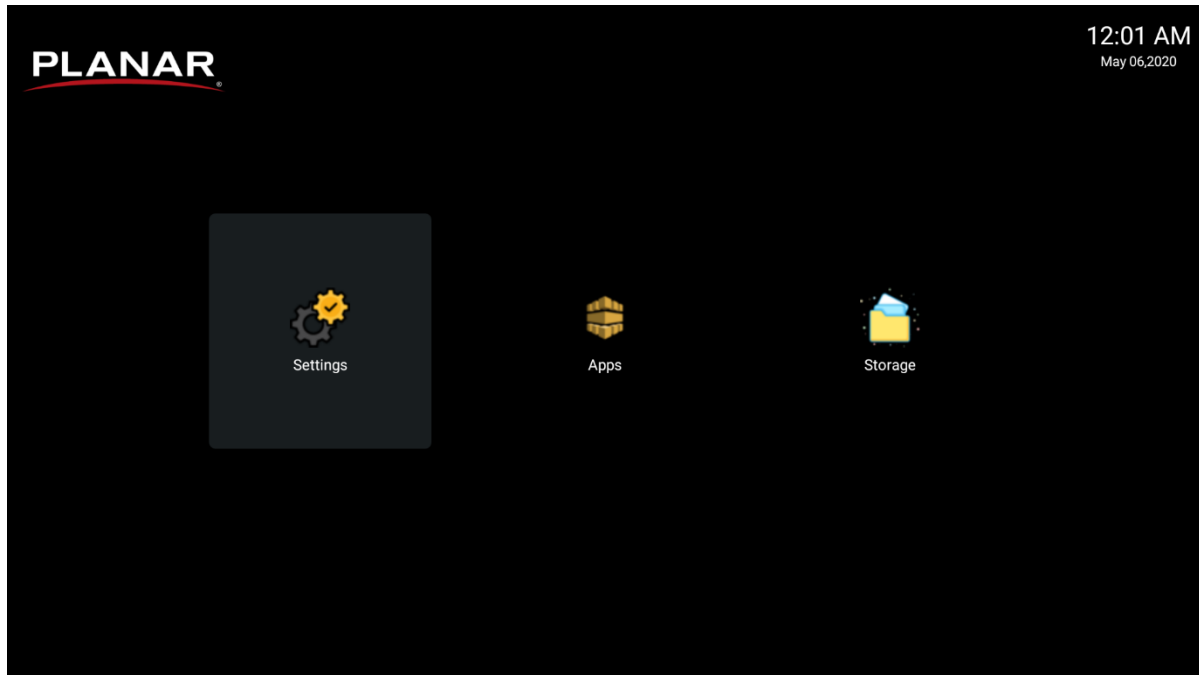

Note: In addition to the IR remote control, use the touchscreen or a USB keyboard and mouse to navigate the Android menu and modify settings.

26.2 Apps

Lists pre-installed apps on the display. Select an app to run it.

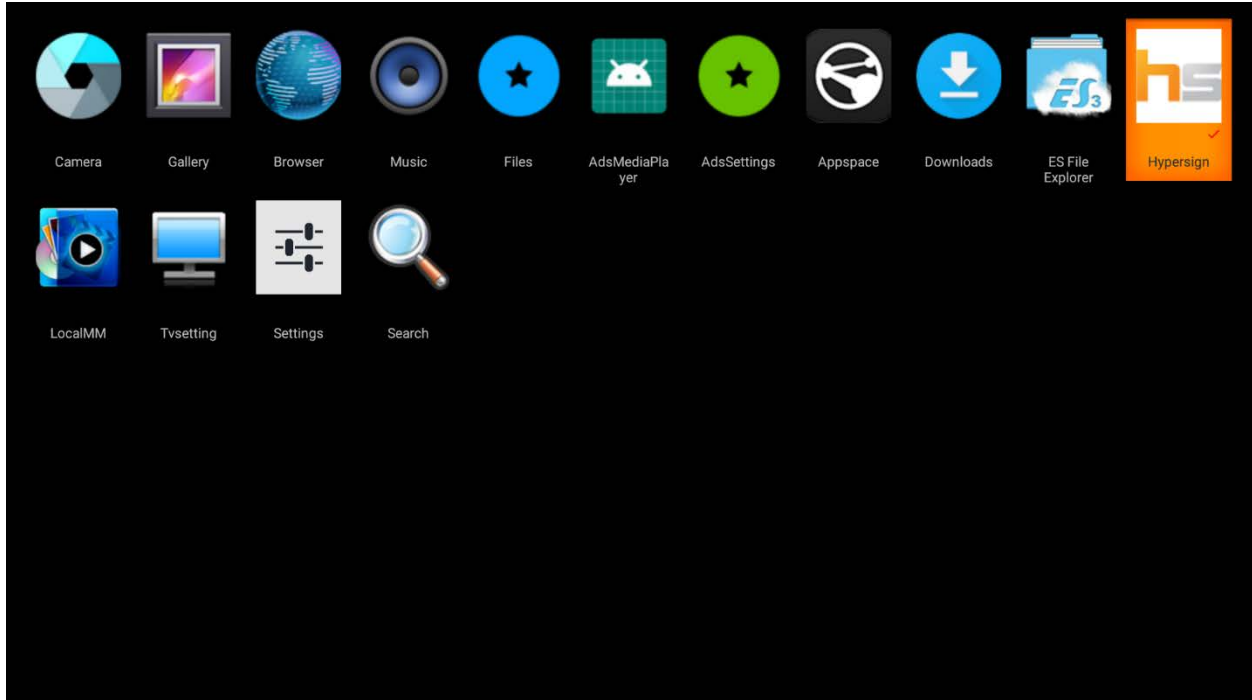

To set a default app, long press on an app and a selection pops up then click on Set to Default.

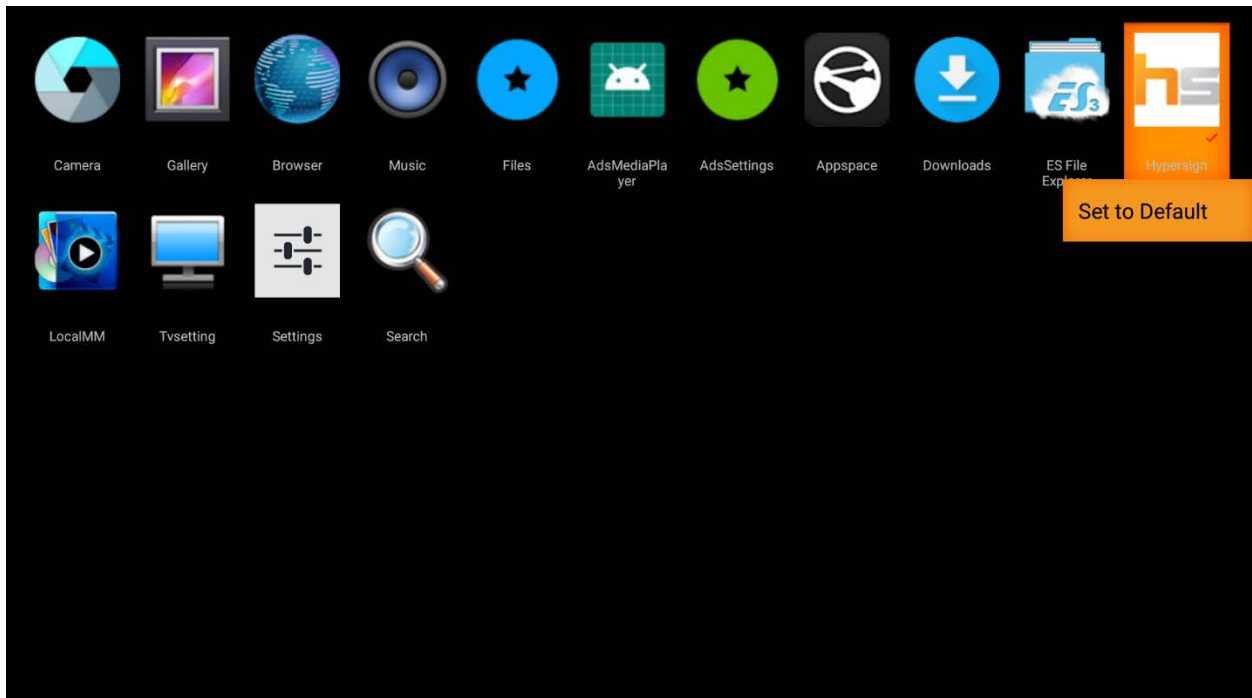

- The default app name will be displayed on the OSD Information Menu (see [page 47](#)).
- By default, the input source of Android App will allow the default app to be automatically

launched at startup.

26.3 Files

Allows management of the internal file system and any drives connected via USB.

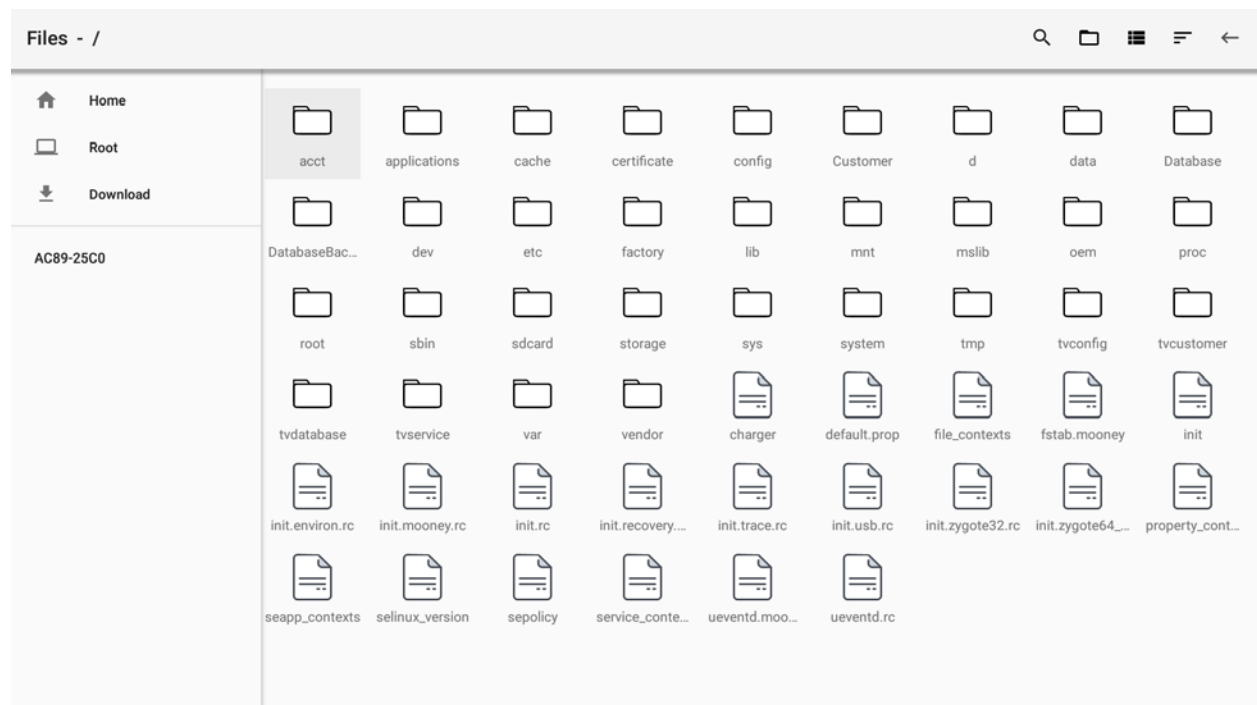

27. Media Player

The Planar PS Series 4K display has an embedded Media Player that can be used to play videos, photos and/or music from a USB Drive. Please see below for more information.

27.1 Supported Media Formats

The table below outline the supported media formats and compatibility for video, audio, and visual content.

Media Player Video Compatibility		
Format	File Types	Max Resolution and Bit Rate
MPEG 1/2	MPEG program stream (.dat, .vob, .mpg, .mpeg) MPEG transport stream (.ts, .trp, .tp) MP4 (.mp4, .mov) 3GPP (.3gpp, .3gp) AVI (.avi) MKV (.mkv)	1080p MP@HL, HD level
MPEG 4	MP4 (.mp4, .mov) 3GPP (.3gpp, .3gp) AVI (.avi) MKV (.mkv)	1080p @ 30fps Divx Home Theater & HD profiles FLV v1 video decoding

Media Player Video Compatibility		
Format	File Types	Max Resolution and Bit Rate
H.264	FLV (.flv) MP4 (.mp4, .mov) 3GPP (.3gpp, .3gp) MPEG transport stream (.ts, .trp, .tp) ASF (.asf) WMV (.wmv) AVI (.avi) MKV (.mkv)	1080p @ 60fps 62.5Mbps
H.265	MP4 (.mp4, .mov) 3GPP (.3gpp, .3gp) MPEG transport stream (.ts, .trp, .tp) MKV (.mkv)	4096x2160 @ 60fps 100Mbps
Google VP8	MKV (.mkv) WebM (.webm)	1080p @ 30fps 50Mbps
Google VP9	MKV (.mkv) WebM (.webm)	4096x2160 @ 60fps 100Mbps
Motion JPEG	AVI (.avi) 3GPP (.3gpp, .3gp) MP4 (.mp4, .mov) MKV (.mkv)	1280 x720 @ 30fps

Media Player Audio Compatibility		
Format	File Types	Max Bit Rate and Sampling Rate
MPEG Audio (MPEG 1/2/2.5 Audio Layer 1/2/3)	MP3	8-320 Kbps 16-48 KHz 2 Channel
Windows Media Audio (WMA Version 7, 8, 9)	WMA	8-768 Kbps 8-96 KHz 2 Channel
AAC Audio (MAIN, ADIF, ATDS Header, AAC-LC, AAC- HE)	AAC M4A	Bit Rate: N/A 8-48 KHz 5.1 Channel

Media Player Image Compatibility		
Format	File Types	Max Resolution
JPEG (JFIF file format 1.2)	JPG JPEG	8192 x 8192
BMP	BMP	8192 x 8192
PNG	PNG	8192 x 8192 (8 bits) 4096 x 8192 (16 bits)

27.2 Main Menu

Play

- This menu starts showing the content in a created playlist. If no playlists are available, create one starting with the Compose section on [page 53](#).
- The content will play in the order selected during content creation, and with the features selected in the Settings menu.

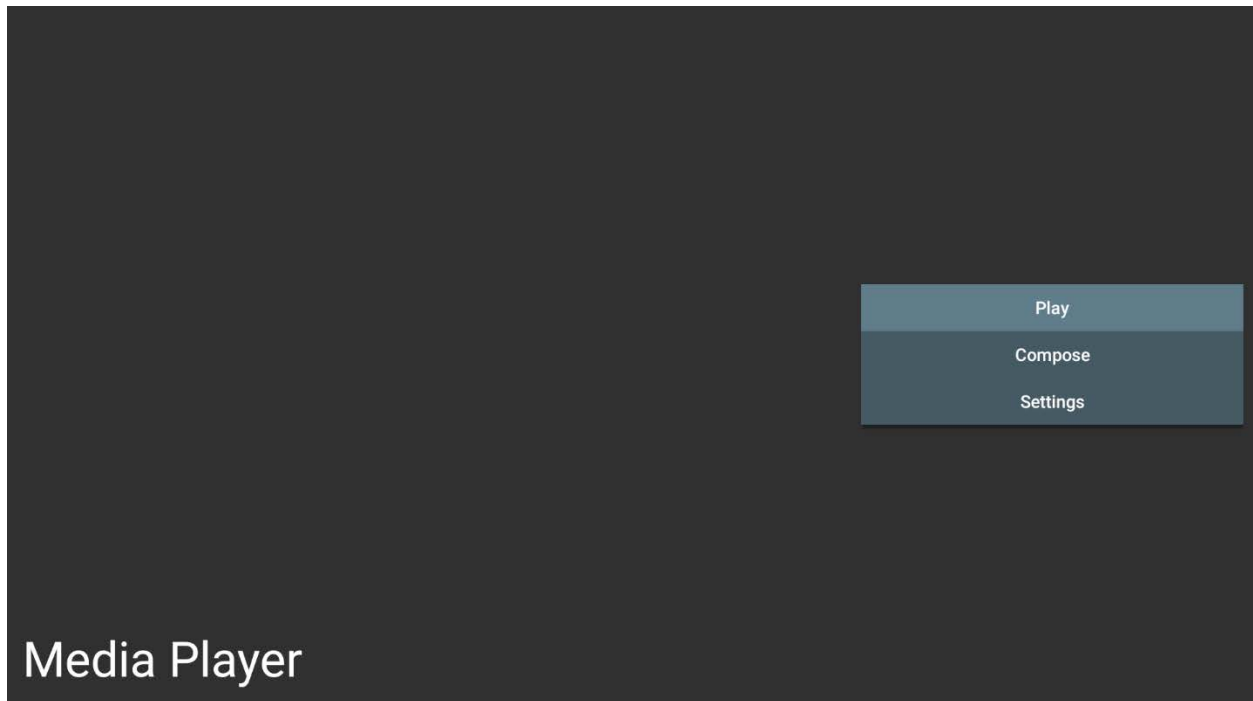

Compose

- Use this menu to create a playlist of photos and/or videos.
- Select media from
 - Internal
 - USB
 - SD card
- Photos must be in the following folder: /planar/photo
- Videos must be in the following folder: /planar/video
- Audio files must be in the following folder: /planar/music

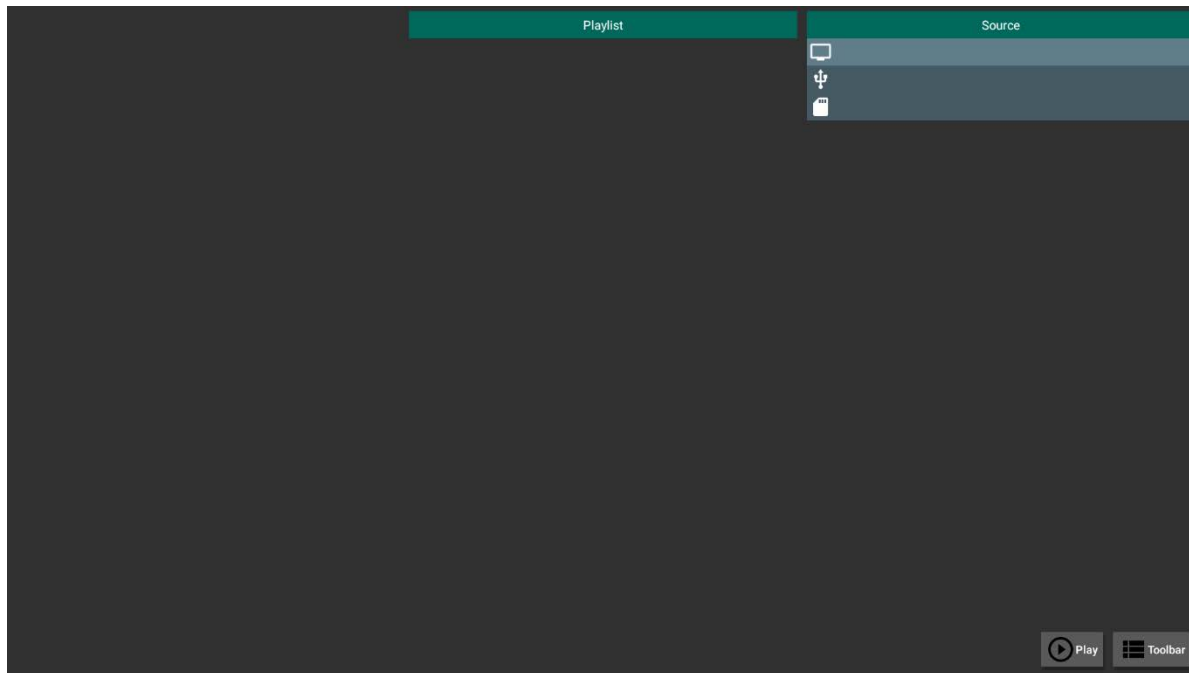

- Press the Toolbar button  on the screen to bring up the sidebar menu

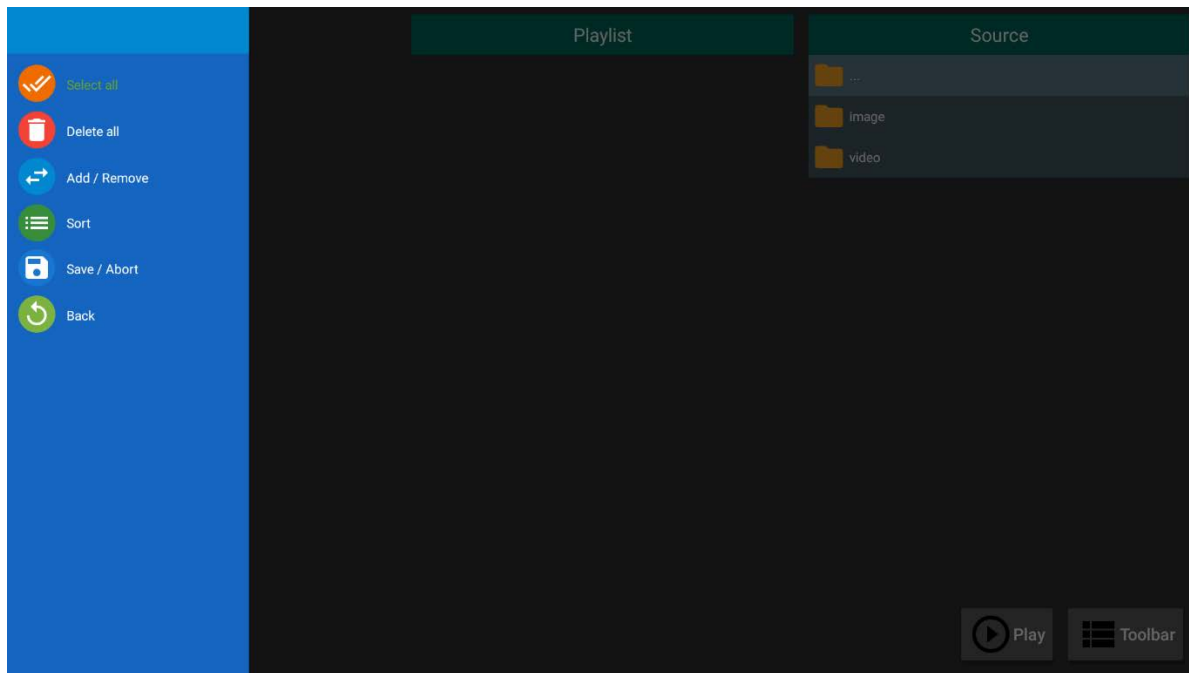

- Delete All: Remove all items from the current playlist
- Add / Remove: Add or keep checked items in the playlist.
- Remove unchecked items from the playlist if present.
- Sort: Rearrange the order of files in the playlist
- Save / Abort: Save or discard the changes to the playlist
 - **Note:** Save changes to the playlist once, modifications are complete. Any unsaved changes will be lost.
- After saving the playlist, background music can be added.
 - **Note:** This option is displayed after saving a playlist (see image below).
- Back: Close the sidebar menu.

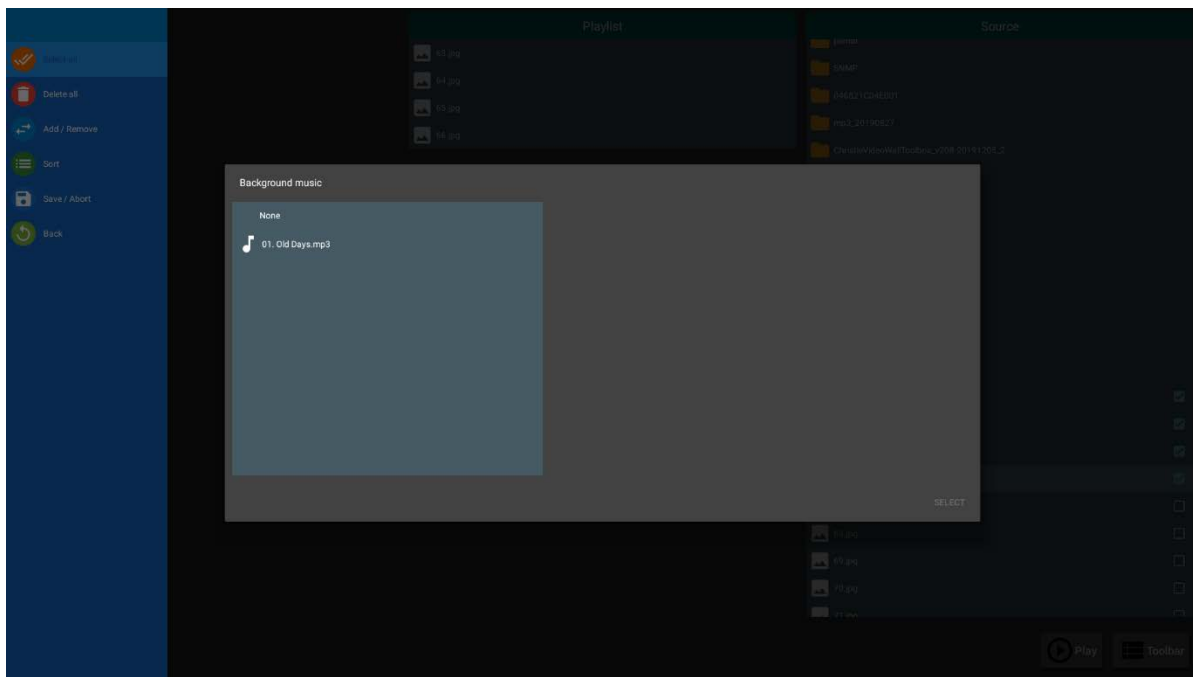

Settings

- This menu contains several options for customizing your playback experience.



- Repeat Mode
 - Play each file only one time or repeat them
 - **Options:** Repeat Once (display each file once), Repeat All (repeat showing all files)
 - **Default:** Repeat All
- Slideshow Effect
 - Select the transition type that occurs when switching from one image to another

- **Options:** Random, Bounce, Fade In/Out, Top to Bottom, Zoom, Left to Right, Right to Left, Fold, Corner, None
- **Default:** None
- Effect Duration
 - Select the amount of time to show each image in the playlist
 - **Options:** 5s, 10s, 15s, 20s
 - **Default:** 5s
- Playback Hint
 - Display the file name as the caption below the image while playing it
 - **Options:** On, Off
 - **Default:** Off

External Control

In addition to using the Planar PS Series 4K remote control and display, there are other methods of controlling the Planar PS Series 4K display externally:

- Using a serial link to send binary commands and to receive responses to those commands. The same set of commands can be sent over RS-232 or TCP. See the *Planar PS Series 4K RS232 User Manual* for more information.
- Using discrete infrared (IR) codes to program a third-party remote control.

Signal Compatibility

Compatible Video Sources								
Signal Type	Resolution	Frame Rate (Hz)	Line Rate (kHz)	Pixel Rate (MHz)	HDMI 1-2	DP	VGA	References
PC	640x480	59.940	31.469	25.175	x	x	x	VESA DMT, CEA-861-F Format 1
	640x480	72.809	37.861	31.500	x	x	x	VESA DMT
	640x480	75.000	37.500	31.500	x	x	x	VESA DMT
	640x480	85.008	43.269	36.000	x	x	x	VESA DMT
	800x600	60.317	37.879	40.000	x	x	x	VESA DMT
	800x600	72.188	48.077	50.000	x	x	x	VESA DMT
	800x600	75.000	46.875	49.500	x	x	x	VESA DMT
	800x600	85.061	53.674	56.250	x	x	x	VESA DMT
	848x480	59.659	29.830	31.500	x	x	x	VESA CVT
	848x480	74.769	37.684	41.000	x	x	x	VESA CVT
	848x480	84.751	42.969	46.750	x	x	x	VESA CVT
	1024x768	60.004	48.363	65.000	x	x	x	VESA DMT
	1024x768	70.069	56.476	75.000	x	x	x	VESA DMT
	1024x768	75.029	60.023	78.750	x	x	x	VESA DMT
	1024x768	84.997	68.677	94.500	x	x	x	VESA DMT
	1152x864	70.012	63.851	94.500	x	x	x	VESA DMT
	1152x864	75.000	67.500	108.000	x	x	x	VESA DMT
	1152x864	84.999	77.094	121.500	x	x	x	VESA DMT
	1280x768	49.929	39.593	65.250	x	x	x	VESA CVT
	1280x768	59.995	47.396	68.250	x	x	x	VESA CVT-R
	1280x768	59.870	47.776	79.500	x	x	x	VESA CVT
	1280x768	74.893	60.289	102.250	x	x	x	VESA CVT
	1280x768	84.837	68.633	117.500	x	x	x	VESA CVT
	1280x960	60.000	60.000	108.000	x	x	x	VESA DMT
	1280x960	75	75.000	126.000	x	x	x	VESA DMT
	1280x960	85.002	85.938	148.500	x	x	x	VESA DMT
	1280x1024	60.020	63.981	108.000	x	x	x	VESA DMT
	1280x1024	75.025	79.976	135.000	x	x	x	VESA DMT
	1280x1024	85.024	91.146	157.500	x	x	x	VESA DMT
	1366x768	59.790	47.712	85.500	x	x	x	VESA DMT
	1400x1050	49.965	54.113	100.000	x	x	x	VESA CVT
	1400x1050	59.948	64.744	101.000	x	x	x	VESA CVT-R
	1400x1050	59.978	65.317	121.750	x	x	x	VESA CVT
	1400x1050	74.867	82.278	156.000	x	x	x	VESA CVT
	1600x1200	60.000	75.000	162.000	x	x	x	VESA DMT
	1920x1080	49.929	55.621	141.500	x	x	x	VESA CVT
	1920x1080	59.963	67.158	173.000	x	x	x	VESA CVT
	1920x1080	59.950	66.587	138.500	x	x	x	VESA CVT-R
	1920x1200	49.932	61.816	158.250	x	x	x	VESA CVT
	1920x1200	59.950	74.038	154.000	x	x	x	VESA CVT-R
1680x1050	49.974	54.121	119.500	x	x	x	VESA CVT	
1680x1050	59.954	65.290	146.250	x	x	x	VESA CVT	
1920x2160	60.000	135.000	297.000	x	x		CEA-861-F, VIC 16, with vertical parameters doubled	
1920x2160	59.988	133.293	277.250	x	x		VESA CVT-R	

Compatible Video Sources								
Signal Type	Resolution	Frame Rate (Hz)	Line Rate (kHz)	Pixel Rate (MHz)	HDMI 1-2	DP	VGA	References
	2560x1440	59.951	88.787	241.500	x	x		VESA CVT-R
	2560x1600	59.972	98.713	268.500	x	x		VESA CVT-R
	3840x2160	23.999	52.438	209.750	x	x		VESA CVT-R
	3840x2160	29.981	65.688	262.750	x	x		VESA CVT-R
	3840x2160	49.977	110.500	442.000		x		VESA CVT-R
	3840x2160	59.997	133.313	533.250		x		VESA CVT-R
Apple Mac	640x480	66.59			x	x	x	
	832x624	75.087	49.107	55.000	x	x	x	
	1024x768	59.278	48.193	64.000	x	x	x	
	1024x768	74.927	60.241	80.000	x	x	x	
	1152x870	75.062	68.681	100.000	x	x	x	
SDTV	480i	60			x			SMPTE 125M, CEA-861-F Formats 6 & 7
	576i	50			x			ITU-R BT.601, CEA-861-F Formats 21 & 22
EDTV	480p	60	31.469	27.000	x	x	x	ITU-R BT.1358, CEA-861-F Format 17 & 18
	576p	50	31.250	27.000	x	x	x	SMPTE 125M, CEA-861-F Format 6 & 7
HDTV	1080i	50	28.125	74.500	x	x	x	SMPTE 274M, CEA-861-F Format 20
	1080i	60	33.750	74.250	x	x	x	SMPTE 274M, CEA-861-F Format 5
	720p	50	37.500	74.250	x	x	x	SMPTE 296M, CEA-861-F Format 19
	720p	60	45.000	74.250	x	x	x	SMPTE 296M, CEA-861-F Format 4
	1080p	24	27.000	74.250	x	x	x	SMPTE 274M, CEA-861-F Format 32
	1080p	25	28.125	74.250	x	x	x	SMPTE 274M, CEA-861-F Format 33
	1080p	30	33.750	74.250	x	x	x	SMPTE 274M, CEA-861-F Format 34
	1080p	50	56.250	148.500	x	x	x	SMPTE 274M, CEA-861-F Format 31
	1080p	60	67.500	148.500	x	x	x	SMPTE 274M, CEA-861-F Format 16
UHDTV	3840x2160	24	54.000	297.000	x	x		CEA-861-F Format 93, HDMI 1.4b VIC 1
	3840x2160	25	56.250	297.000	x	x		CEA-861-F Format 94, HDMI 1.4b VIC 2
	3840x2160	30	67.500	297.000	x	x		CEA-861-F Format 95, HDMI 1.4b VIC 3
	3840x2160	50	67.500	297.000				CEA-861-F Format 96, 4:2:0 sub-sampling
	3840x2160	50	135.000	594.000		x		CEA-861-F Format 96
	3840x2160	60	67.500	297.000				CEA-861-F Format 97, 4:2:0 sub-sampling
	3840x2160	60	135.000	594.000		x		CEA-861-F Format 97
	4096x2160	24	54.000	297.000	x	x		CEA-861-F Format 98
	4096x2160	25	56.250	297.000	x	x		CEA-861-F Format 99
	4096x2160	30	67.500	297.000	x	x		CEA-861-F Format 100

Color Subsampling Support

Video Timing	Input	RGB 4:4:4 Supported	YUV 4:4:4 Supported	YUV 4:2:2 Supported	YUV 4:2:0 Supported
4K @ 50/60Hz	HDMI 1-4	x	x	x	x
All Other Supported Timings	All	x	x	x	

Specifications

Item	PS5074K PS5074K-N	PS5074KT PS5074KT-N	PS5574K PS5574K-N	PS5574KT PS5574KT-N	PS6574K PS6574K-N	PS6574KT PS6574KT-N
LCD Panel						
Display Technology	Commercial-Grade VA LCD					
Resolution	3840x2160					
Aspect Ratio	16:9					
Screen Size	50"		55"		65"	
Orientation	Landscape / Portrait					
Brightness (Typ.)	550 cd/m ²	500 cd/m ²	550 cd/m ²	500 cd/m ²	450 cd/m ²	400 cd/m ²
Contrast Ratio	4000:1					
Viewing Angle (Typ.)	178 degrees					
Response Time (Typ.)	8ms					
Color Gamut	72% NTSC					
Display Color	1.07 billion (10-bit depth)					
Connectivity						
Standard Inputs	HDMI 2.0 x 2, DisplayPort 1.2, VGA					
HDCP 2.2	Yes (HDMI)					
Audio Output	Line out, S/PDIF out					
Control and Monitoring	LAN RJ45, WiFi (802.11 b/g/n, 2.4 GHz), RS232 In, IR In, Keypad NOTE: Models ending in -N do not include WiFi					
Operating System	Android 6.0					
Mechanical						
Display Dimensions	44.6" x 25.8" x 2.8" (1132.6mm x 655.8mm x 69.9mm)	45.2" x 26.3" x 3.4" (1148.4mm x 669mm x 87.3mm)	49.0" x 28.3" x 2.7" (1245.2mm x 718.5mm x 69mm)	49.7" x 28.9" x 3.4" (1262.4mm x 733mm x 86.4mm)	57.6" x 33.2" x 2.8" (1462.6mm x 843.3mm x 70mm)	58.3" x 33.7" x 3.4" (1481.5mm x 856.4mm x 85.8mm)

Bezel Width	16.9mm (top/left/right) 19.4mm (bottom)	22.8mm even	16.6mm (top/left/right) 19.1mm (bottom)	22.8mm even	16mm (top/left/right) 21.8mm (bottom)	23mm even
Display Weight	33 lbs (15 kg)	54 lbs (25 kg)	40 lbs (18 kg)	65 lbs (30 kg)	54 lbs (25 kg)	88 lbs (40 kg)
Mounting	VESA 400 mm x 400 mm					
Fanless	Yes					
Speakers	10W x 2 built-in					
Touch Related						
Protective Glass	Not applicable	4mm with AG coating	Not applicable	4mm with AG coating	Not applicable	4mm with AG coating
Touch Technology	Not applicable	IR 20-point	Not applicable	IR 20-point	Not applicable	IR 20-point
Touch Interface	Not applicable	USB-B	Not applicable	USB-B	Not applicable	USB-B
Usage						
Recommended Usage	24x7					
Backlight	D-LED					
Backlight Life	30,000 hours min					
Power Source						
Power Consumption (Typ.)	115W		145W		120W	
BTU/hr (Typ.)	115Wx 3.42 BTU = 393 BTU/hr		145Wx 3.42 BTU = 496 BTU/hr		120Wx 3.42 BTU = 410 BTU/hr	
Standby Power Consumption	< 0.5W					
Input Voltage / Frequency	AC 100-240V 50-60 Hz					
AC Inlet Type	C14					
Environment						
Storage Temperature	Min -4°F ~ Max 140°F (-20°C ~ 60°C)					
Operating Temperature	Min 32°F ~ Max 104°F (0-40°C) at up to 3000 m					
Humidity	20-85% RH					
Approvals	FCC Class A, cTUVus, CE					

Dimensions

PS5074K, PS5074K-N

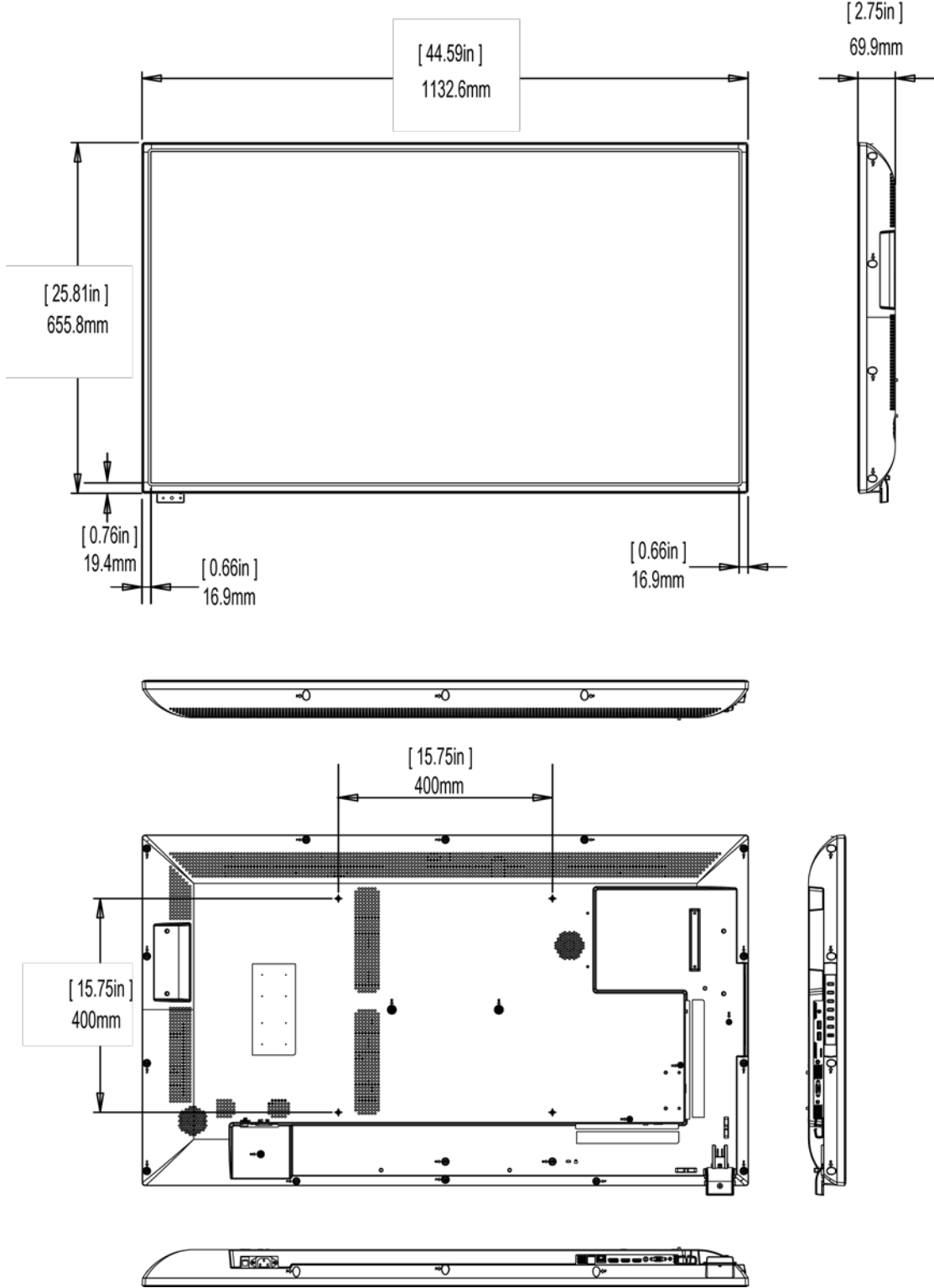

PS5074KT, PS5074KT-N

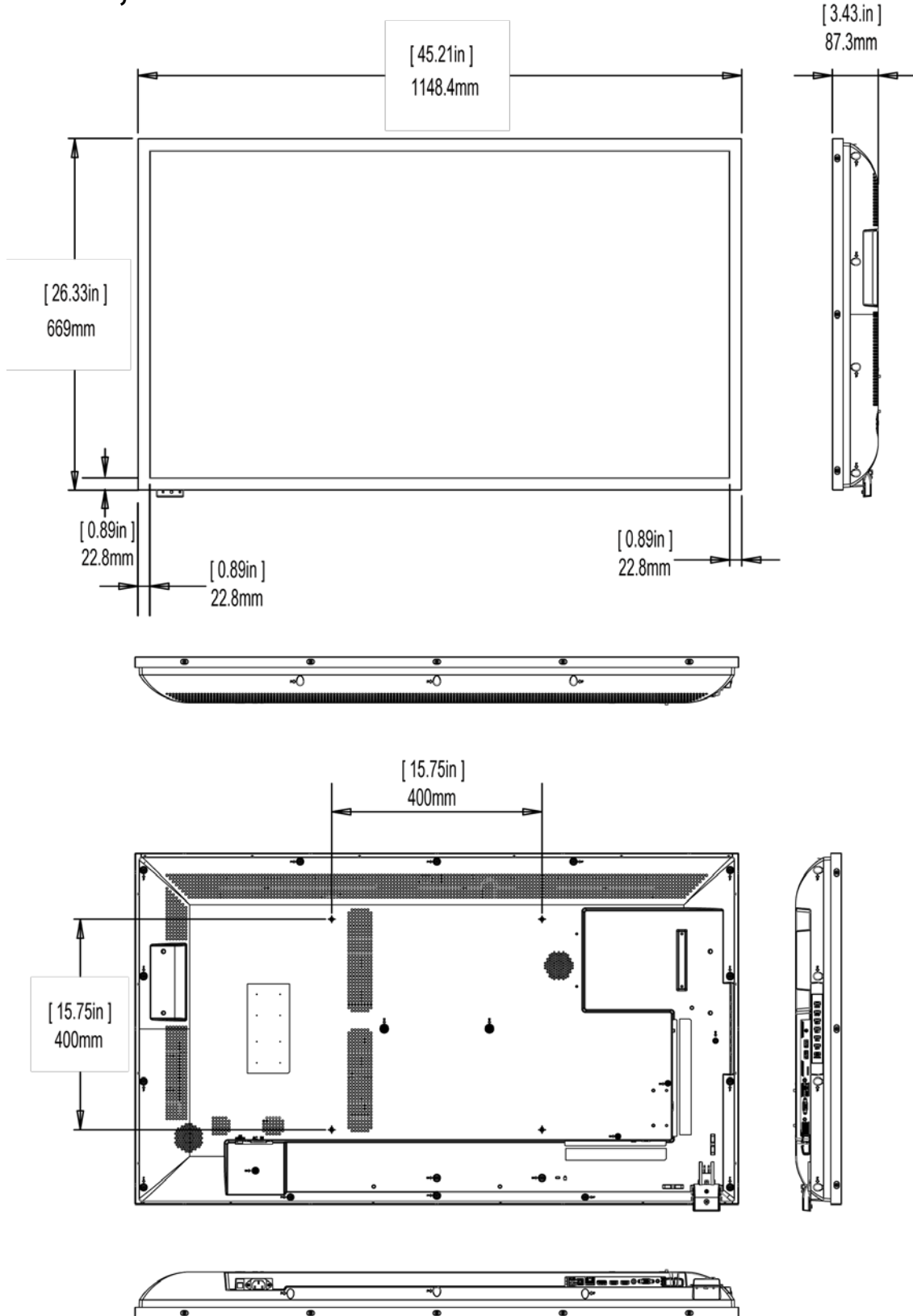

PS5574K, PS5574K-N

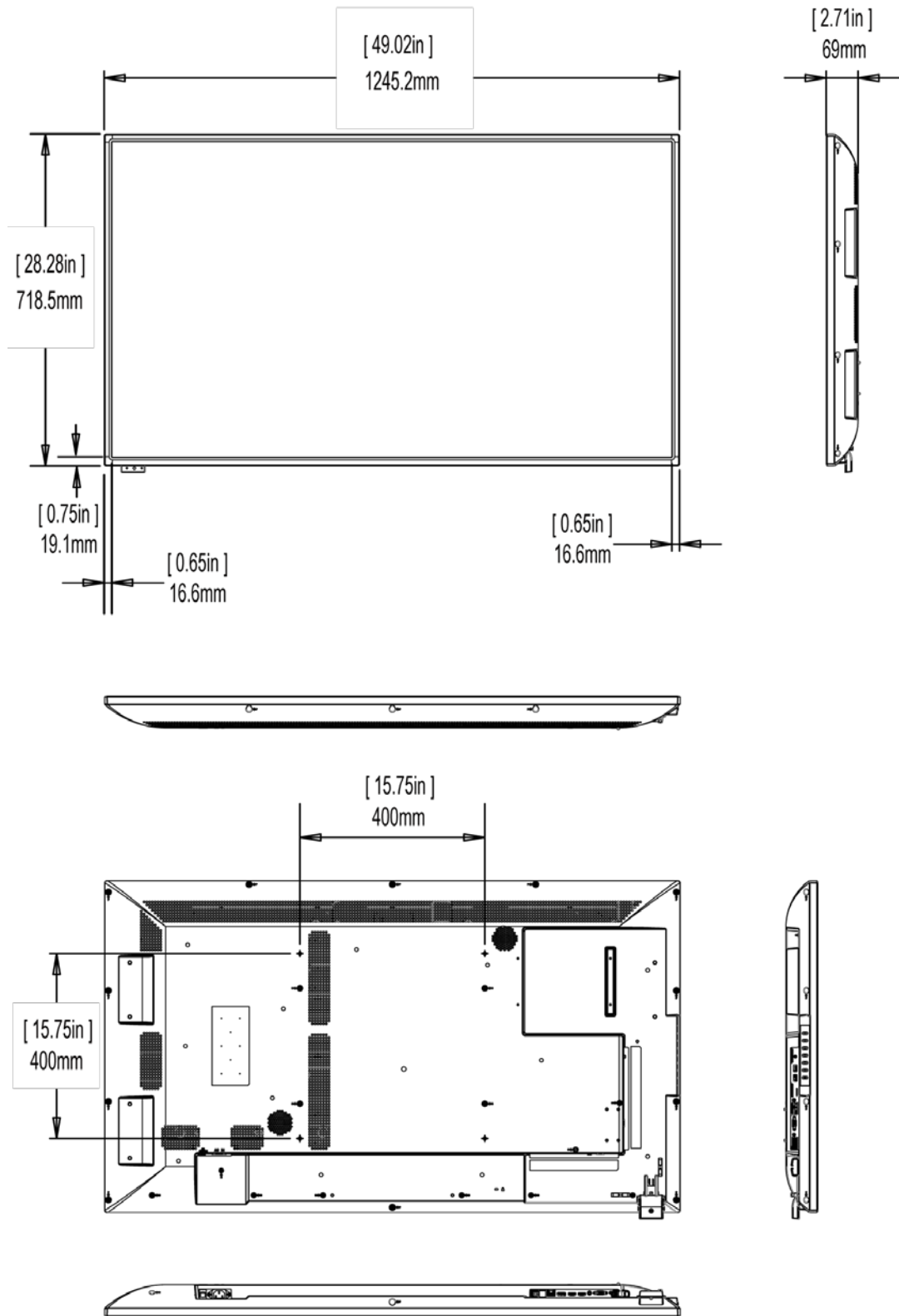

PS5574KT, PS5574KT-N

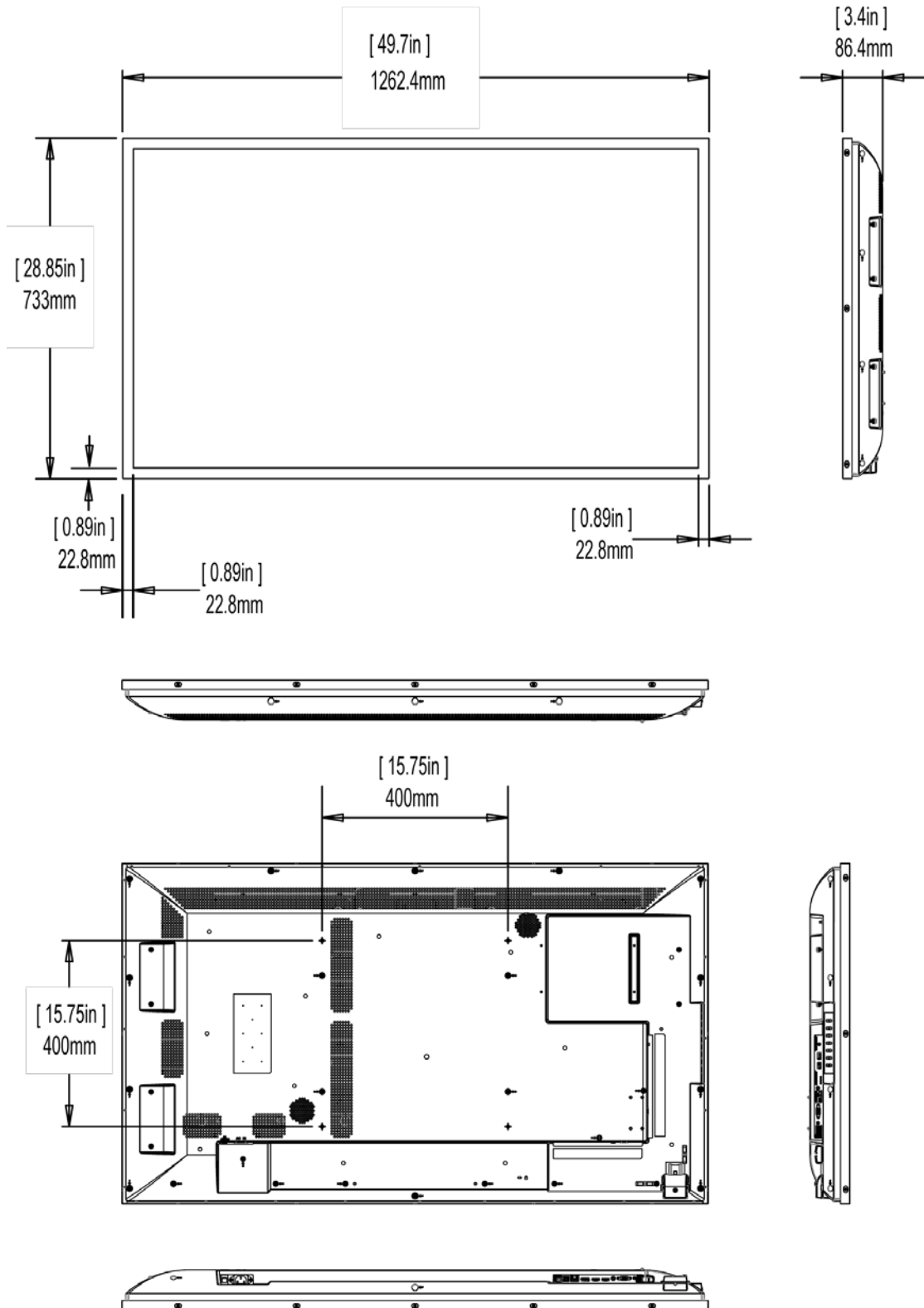

PS6574K, PS6574K-N

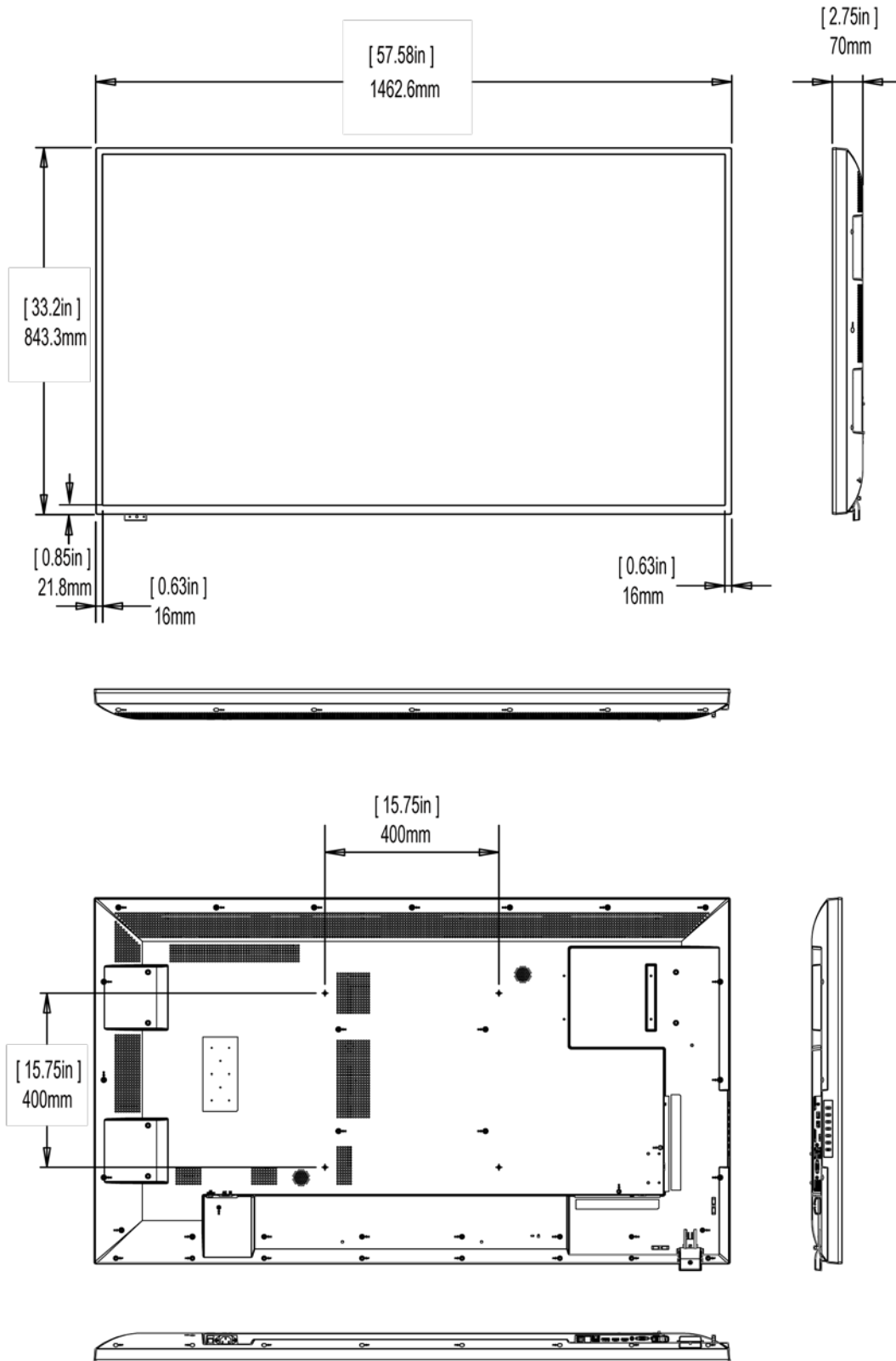

PS6574KT, PS6574KT-N

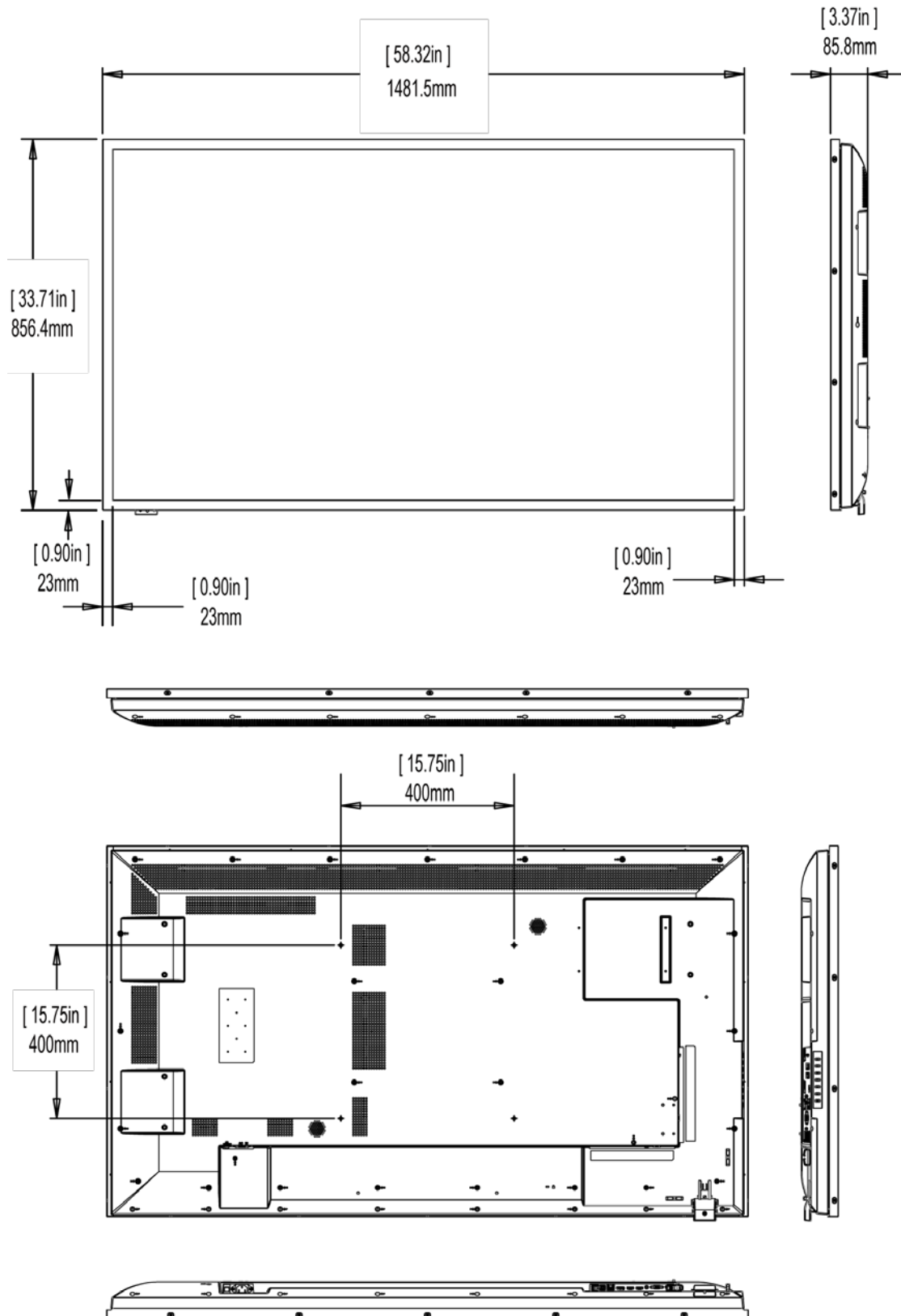

Troubleshooting

Before calling service personnel, please check the following table for a possible cause of the problem you are experiencing. Please note the following:

- Perform the adjustments according to "Operating the Display" on [page 18](#).
- If the problem you are experiencing is not described below, or you cannot correct the problem, stop using the display and contact Planar's Technical Support Department. See "Accessing the Planar Technical Support Website" on [page 69](#).

Issue	Check for the following
No image is displayed	Make sure the correct source is selected.
	Make sure the main power switch is ON.
	Check that the source equipment is operating correctly.
	Make sure the input signal is compatible with this display.
The image is not centered	Make sure the input signal is compatible with this display.
The remote control doesn't work	Make sure the batteries are new and installed correctly. Ensure the remote is aimed at the IR sensor.
	Make sure the remote control sensor is plugged in correctly.
	Make sure the remote is aimed towards the back of the display where the sensor is located.
The picture color looks poor	Check the picture settings. Reset the display

Accessing the Planar Technical Support Website

Go to <http://www.planar.com/support/> to locate the following support documents and resources:

- User Guide
- RS232 User Manual
- Standard Warranties
- Planar support hotline number and email

Index

A

- Accessory Kit, 14
- Adjust
 - Volume, 28
- Advanced Settings, 23, 42, 47
- Android Settings Menu, 48
- Audio, 34
- Audio Compatibility, 51
- Audio Settings, 33

B

- Batteries, 13

C

- Cable Clips, 13
 - Installing, 14
- Cable Length Recommendations, 17
- Cleaning the Display, 11
- Color Subsampling Support, 59
- Configuration 1, 36
- Configuration 2, 23, 40, 42, 47
- Cooling Requirements, 9, 16

D

- Definition, 30
- Dimensions, 62

E

- External Control, 56

H

- HDMI
 - Installing the Display, 17
 - Package contents, 12

I

- Image Compatibility, 51
- Important Waste Disposal Information, 9 information, 47
- Input Menu, 29
- Installing the Display, 16

L

- LED Indicators, 21
- Locking, 27

M

- Menus
 - Audio Settings, 29
 - Basic Settings, 29
 - Display Settings, 29

N

- Normal Usage Guidelines, 9

O

- Operating the Display, 18
- OSD Keypad, 18

P

- Package Contents, 12
- Plan Your Installation
 - Install, 16

R

- Remote Control Receiver, 19, 20

S

- Safety, 6
- Safety Instructions, 7
- Signal Compatibility, 57

T

- Temporary Image Retention, 8
- Troubleshooting, 68

U

- Unlocking, 27

V

- VESA Mounts, 10
- Volume, 18, 28, 33

W

- Warranty Coverage, 8
- What is Temporary Image Retention?
 - Image Retention, 8