

Planar[®] UltraRes[™] X Series

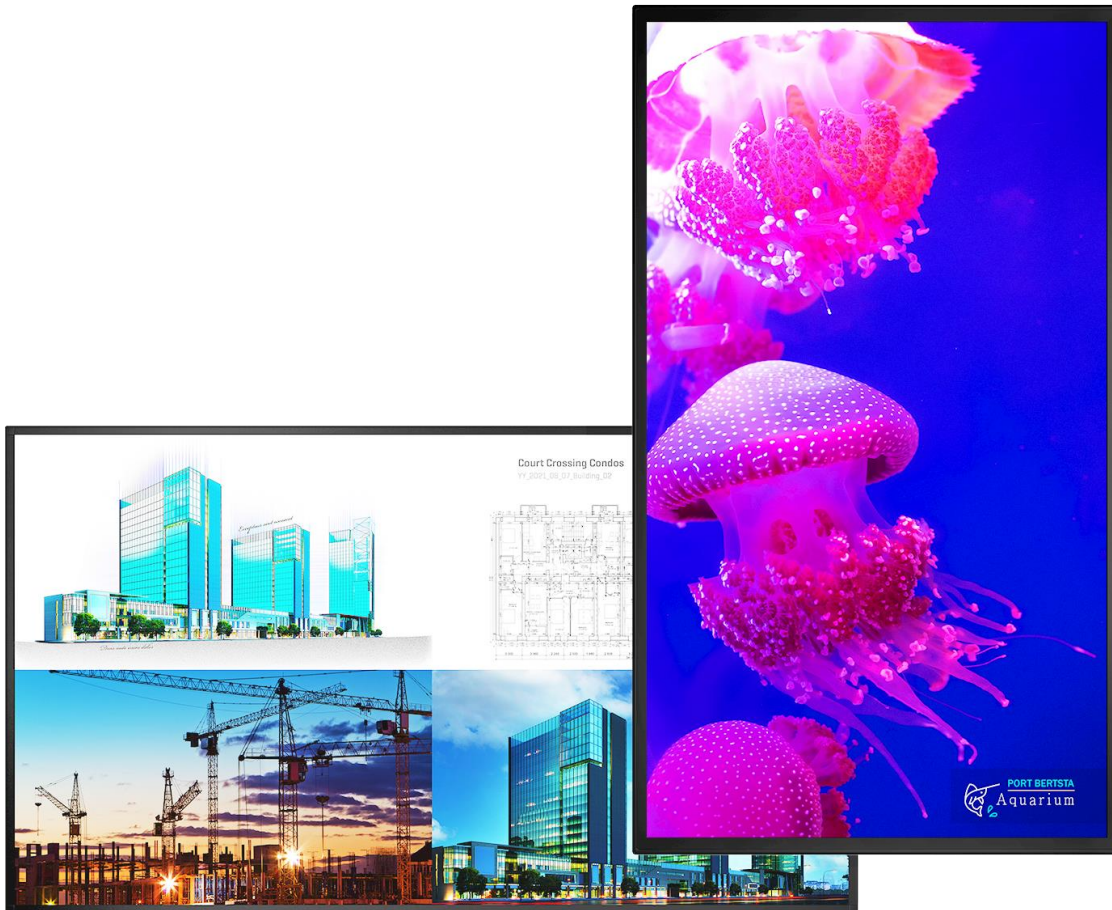

- URX75**
- URX75-ERO**
- URX75-ERO-T**
- URX85**
- URX85-ERO**
- URX85-ERO-T**
- URX100**
- URX100-ERO**
- URX100-ERO-T**

Copyright © March 2021 by Planar Systems, Inc.
All rights reserved.

This document may not be copied in any form without permission from Planar. Information in this document is subject to change without notice.

Trademark Credits

Windows™ is a trademark of Microsoft Corp.
All other companies are trademarks or registered trademarks of their respective companies.

Disclaimer

The information contained in this document is subject to change without notice. Planar Systems, Inc. makes no warranty of any kind with regard to this material. While every precaution has been taken in the preparation of this manual, the Company shall not be liable for errors or omissions contained herein or for incidental or consequential damages in connection with the furnishing, performance, or use of this material.

Warranty and Service Plans

Planar warranty and service plans will help you maximize your investment by providing great support, display uptime, and performance optimization. From post-sale technical support, to a full suite of depot services, our services are performed by trained employees. When you purchase a Planar product, you get more than a display; you get the service and support you need to maximize your investment. To find the latest warranty and service information regarding your Planar product, please visit <http://www.planar.com/support>

RoHS Compliance Statement

The Planar UltraRes X Series is fully RoHS compliant.

Part Number: 020-1396-00A

Table of Contents

Introduction	5
1. Safety Information.....	6
2. Safety Precautions.....	6
2.1 Important Safety Instructions.....	7
3. Recommended Usage	8
3.1 Burn-In Versus Temporary Image Retention.....	8
3.2 Warranty Coverage.....	8
3.3 Important Waste Disposal Information.....	9
3.4 Normal Usage Guidelines.....	9
4. Cleaning the Display	10
Unpacking and Checking Accessories.....	11
5. Package Contents.....	11
6. Accessory Kit.....	12
7. Planar UltraRes X Series – Standard Inputs	13
Installing the Display	15
8. Mounting with a VESA Mount.....	16
9. Installing the Optional Planar Profile Mounting System	17
9.1 Using the Lifting Eyes	25
9.2 Cable Length Recommendations	26
10. Installing OPS Expansion (Optional)	27
Operating the Display	28
11. OSD Keypad.....	28
12. Remote Control Receiver.....	29
13. LED Indicators	30
14. Using the Display in Portrait Mode	30
15. Using the Display in Flat or Tilted Orientation.....	30
16. Using the Remote Control.....	31
17. IR Command Protocol	32
17.1 Locking the Keypad and IR Remote.....	35
17.2 Unlocking the Keypad and IR Remote	35
17.3 Changing the IR Remote Code Set.....	35
17.4 Turning the Display On.....	35
17.5 Turning the Display Off.....	36
17.6 Adjusting the Volume	36
17.7 Selecting Layouts and Input Sources	36
17.8 Navigating Through the Menus	37
18. Inputs and Views Menu	38
18.1 Image Adjust Menu	40
18.2 Audio Menu.....	43
18.3 Presets Menu.....	44
18.4 Advanced Settings Menu	45
18.5 Information Menu	67
19. Using the Touch Screen	70
19.1 Touchscreen MultiTouch Driver Installation	70
19.2 Touchscreen (PQLabs) MultiTouch Platform Content	70

19.3	Uninstalling the MultiTouch Driver	71
	Planar UltraRes X Series Remote Monitoring Software	72
20.	Remote Monitoring Home	72
21.	Remote Monitoring System Information	72
22.	Remote Monitoring Inputs and Views	73
23.	Remote Monitoring Audio	74
24.	Remote Monitoring Presets	75
25.	Remote Monitoring Panel Brightness and Power	76
26.	Remote Monitoring Notifications	77
27.	Remote Monitoring System Settings	79
28.	Remote Monitoring Access Control	80
	External Control	81
	HDR	82
	Signal Compatibility	83
	Color Subsampling Report	87
	Power Consumption	88
	Specifications	89
	Dimensions	92
29.	URX75	92
29.1	URX75 Standard	92
29.2	URX75-ERO	93
29.3	URX75-ERO-T	94
30.	URX85	95
30.1	URX85 Standard	95
30.2	URX85-ERO	96
30.3	URX85-ERO-T	97
31.	URX100	98
31.1	URX100 Standard	98
31.2	URX100-ERO	99
31.3	URX100-ERO-T	100
	Troubleshooting During Installation	101
32.	Error Codes	101
33.	Symptoms, Possible Causes and Solutions	102
33.1	Symptom: Can't Get PC to Output 4K @ 24/30/60 Hz	102
33.2	Symptom: Can't Get PC to Output 4K @ 24/30/60 Hz	103
33.3	Symptom: Can't Select OPS or HDMI 1	103
33.4	Symptom: IR Isn't Working Properly	104
33.5	Symptom: Touch Has Broken Response Near Middle/Bottom of Display	104
	Accessing Planar's Technical Support Website	105

Introduction

The Planar® UltraRes X™ Series is a line of 75", 85" and 100" 4K resolution (3840 x 2160) professional LCD displays with 700-nit brightness and wide color gamut perfect for High Dynamic Range (HDR) content.

The displays offer superior visual performance with multi-source viewing and advanced processing ideal for applications ranging from collaborative meeting spaces to high-impact digital signage and media rooms. Models ruggedized with Planar® ERO-LCD™ (Extended Ruggedness and Optics™) are available, as well as extremely responsive interactive models with up to 32-point touch.

The Planar UltraRes X Series supports native 4K resolution at up to 60Hz via HDMI 2.0 and DisplayPort 1.2, enabling smooth motion video and mouse tracking. The displays' HDMI 2.0 inputs are also HDCP 2.2 compliant. It features redundant power and Crestron drivers for versatility.

Features of the Planar UltraRes X Series displays include:

- 75", 85" and 100" 4K LCD displays
- Bright 700 nits
- Wide color gamut
- HDR compatible
- Optional thin-profile mounting system
- Optional responsive touch screen
- Optional Planar ERO-LCD protective glass
- Multi-source viewing with Planar MediaPlex Plus processing

1. Safety Information

Before using the Planar UltraRes X Series, please read this manual thoroughly to help protect against damage to property, and to ensure personnel safety.

- Be sure to observe the following instructions.
- For your safety, be sure to observe ALL the warnings detailed in this manual.
- For installation or adjustment, please follow this manual's instructions, and refer all servicing to qualified service personnel.

2. Safety Precautions

- **If water is spilled or objects are dropped inside the display, remove the power plug from the outlet immediately.** Failure to do so may result in fire or electrical shock. Contact your dealer for inspection.
- **If the display is dropped or the chassis is damaged, remove the power plug from the outlet immediately.** Failure to do so may result in fire or electrical shock. Contact your dealer for inspection.

WARNING! Wall mounts must be secure.

- **If the display is hung on a wall, the wall must be strong enough to hold it.** Simply mounting it to wallboard or wall paneling won't be adequate or safe.

Caution: For Non-ERO Models:

- The front polarizer of non-ERO URX models is soft and subject to scratches from sharp objects.
- Slight pressure on the LCD of non-ERO URX models will cause distortion of the image. Heavier pressure will cause permanent damage.

Caution: For All URX Models:

- Displays should be mounted where viewers cannot insert small objects in the openings that will create hazards by contacting bare conductive parts.
- If the power cord or plug is damaged or becomes hot, turn off the main power switch of the display. Make sure the power plug has cooled down and remove the power plug from the outlet. If the display is still used in this condition, it may cause a fire or an electrical shock. Contact your dealer for a replacement.

2.1 Important Safety Instructions

1. Read these instructions.
2. Keep these instructions.
3. Heed all warnings.
4. Follow all instructions.
5. Do not use the display near water.
6. Clean the LCD screens with an LCD screen cleaner or LCD wipes.
7. Do not install near any heat sources such as radiators, heat registers, stoves or other apparatus (including amplifiers) that produce heat.
8. Do not defeat the safety purpose of the polarized or grounding type plug. A polarized plug has two blades with one wider than the other. A grounding type plug has two blades and a third grounding prong. The wide blade or the third prong is provided for your safety. When the provided plug does not fit into your outlet, consult an electrician for the replacement of the obsolete outlet.
9. Protect the power cord from being walked on or pinched, particularly at plugs, convenience receptacles and the point where they exit from any Planar large format LCD display.
10. Only use the attachments/accessories specified by the manufacturer.
11. Unplug all displays during lightning storms or when unused for long periods of time.
12. In instances where a power surge has occurred and a display no longer has an image, the display power will need to be reset.
13. You must follow all National Electrical Code regulations. In addition, be aware of local codes and ordinances when installing your system.
14. Refer all servicing to qualified service personnel. Servicing is required when any of the displays have been damaged in any way. For example, if the AC power cord or plug is damaged, liquid has been spilled or objects have fallen into a display, the displays have been exposed to rain or moisture, do not operate normally or have been dropped.
15. Keep the packing material in case the equipment should ever need to be shipped.
16. Wall mounts must be secure. The wall must be strong enough to hold displays brackets, cables and accessories. Seismic engineers should be consulted in areas prone to earthquakes.
17. **Caution:** There is a risk of explosion if the battery is replaced with incorrect type. Dispose of used batteries according to local regulations.

3. Recommended Usage

In order to get the most out of your LCD, use the following recommended guidelines to optimize the display.

3.1 Burn-In Versus Temporary Image Retention

Burn-in causes the screen to retain an image essentially forever, with little or no way to correct the problem. Under normal use, an LCD will not experience burn-in, as plasma displays do, nor will it retain images in any way.

Normal use of an LCD is defined as displaying continuously changing video patterns or images. However, LCDs can experience *temporary* image retention when recommended usage guidelines are not followed.

What is Temporary Image Retention?

Temporary image retention (TIR) can occur when a static image is displayed continuously for extended periods of time (12 hours or longer). An electrical charge differential may build up between the electrodes of the liquid crystal, which causes a negative-color video image (color-inverted and brightness-inverted version of the previous image) to be retained when a new image is displayed. This behavior is true for any LCD device from any LCD manufacturer.

TIR is not covered under warranty. See standard warranty terms and conditions for details. Here are some guidelines to help you avoid TIR:

- Use the LCD to show a screen saver, moving images or still pictures that change regularly. When using high-contrast images, reposition the images frequently.
- Turn off the LCD when it is not in use. To use your source computer's Power Options Properties, set up your computer to turn off the display when not in use.

3.2 Warranty Coverage

The following models are warranted for **24 x 7** usage:

- 75": URX75, URX75-ERO, URX75-ERO-T
- 85": URX85, URX85-ERO, URX85-ERO-T
- 100": URX100, URX100-ERO, URX100-ERO-T

Planar recommends turning off the power for **4 hours per day** for optimal performance.

For complete warranty details, please visit <http://www.planar.com/warranty>.

3.3 Important Waste Disposal Information

Please recycle or dispose of all electronic waste in accordance with local, state, and federal laws. Additional resources can be found online at <http://www.planar.com/about/green/>.

The crossed-out wheelee bin symbol is to notify consumers in areas subject to Waste Electrical and Electronic Equipment (WEEE) Directive 2012/19/EU that the product was placed on the market after August 13, 2005 and must not be disposed of with other waste. Separate collection and recycling of electronic waste at the time of disposal ensures that it is recycled in a manner that minimizes impacts to human health and the environment. For more information about the proper disposal of electronic waste, please contact your local authority, your household waste disposal service, or the seller from whom you purchased the product.



3.4 Normal Usage Guidelines

Normal use of the LCD is defined as operating in the open air to prevent heat buildup, and without direct or indirect heat sources such as lighting fixtures, heating ducts, or direct sunlight that can cause the displays to experience high operating temperatures. For all displays, do not block fans or ventilation openings. If the LCD display will be installed in a recessed area with an LCD surround or enclosure, ensure adequate openings are applied for proper air flow and ventilation.

It is up to the installer to ensure that display placement is changed, thermal shielding is provided and/or additional ventilation is provided to keep the display within its nominal operating parameters. Maximum ambient operating temperatures for the Planar UltraRes X Series are:

- 75" and 100" Planar UltraRes X Series models: 0-40°C at up to 3000 meters
- 85" Planar UltraRes X Series models: 0-40°C at up to 1500 meters and 0-35°C at up to 3000 meters

Cooling Requirements

For optimal performance, active cooling by the installer should be planned for when the ambient temperature anywhere in the wall is predicted to be above the specified ambient temperature for the display.

4. Cleaning the Display

If dust has collected on the power plug, remove the plug from the outlet and clean off the dust. Dust build-up may cause a fire.





Remove the power plug before cleaning. Failure to do so may result in electrical shock or damage.

Keep the following points in mind when cleaning the surface of the display:







- When the surface of the display becomes dirty, wipe the surface lightly with a soft clean cloth.
- If the surface requires additional cleaning, use LCD screen cleaner or LCD wipes, which are available at most electronics stores.
- Do not let cleaner seep into the display, as it may cause electrical shock or damage.
- Refer to the Planar Display Cleaning Guidelines for more information.

Unpacking and Checking Accessories

5. Package Contents

Part	Description	Number	Picture
LCD Display	One per box.	1	
Planar UltraRes X Profile Mount Brackets (optional)	For hanging of Planar UltraRes X products.	2 Note: 75" portrait products come with only a single mount bracket.	
Planar UltraRes X Service Brackets (optional)	For placing a Planar UltraRes X product in service mode and locking the panel in place when installed.	2	
Planar UltraRes X Profile Mount Install Template (optional)	For use when installing Planar UltraRes X Profile Mounts.	1	

6. Accessory Kit

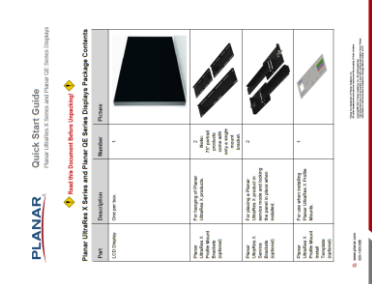
Part	Description	Number	Picture
AC power cord	Power cord	1	
IR sensor	Used to receive signals from the remote control.	1	
HDMI cable	HDMI cable.	1	
USB cable	Connects to a PC for touch functionality (touch models only) and serial commands (all models).	1	
Remote control	Used to control the display. Two AAA batteries are included but not installed.	1	
Carrying Strap	For lifting and carrying the display using three people.	2	
Planar® TouchMark™ Single License Key Card	Annotation and whiteboarding software (touch models only)	1	
Quick Start Guide: Planar UltraRes X Series and Planar QE Series Displays		1	

7. Planar UltraRes X Series – Standard Inputs

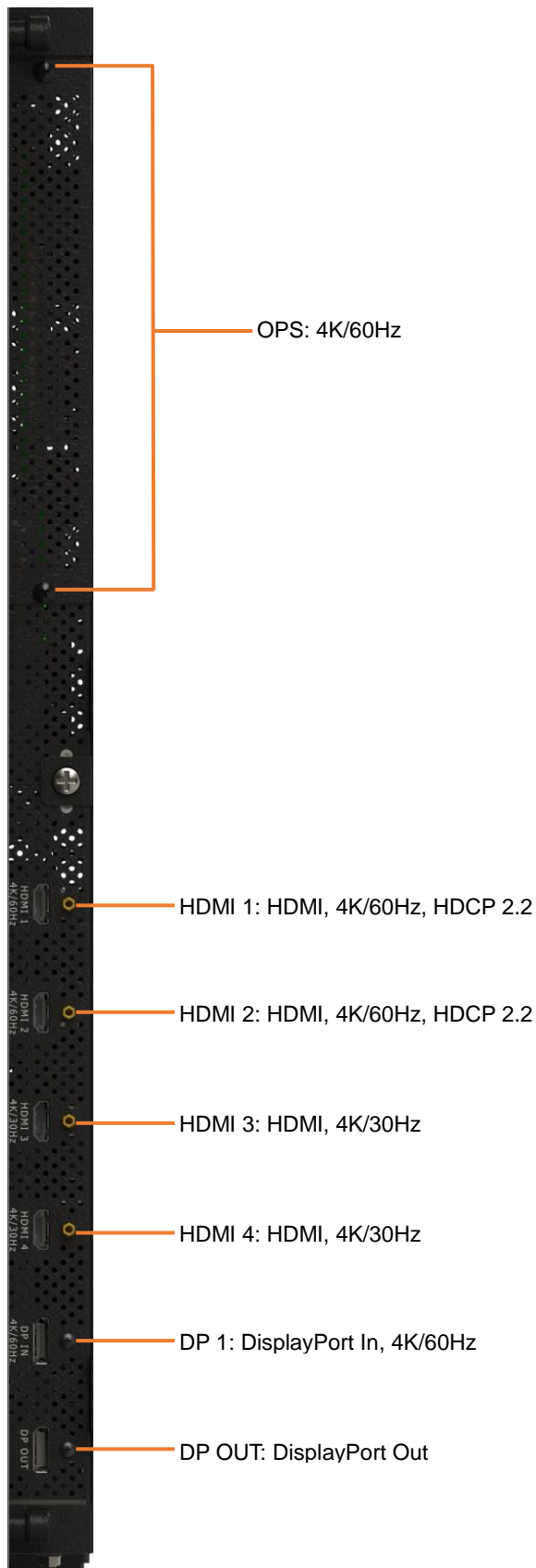

Note: Only one HDCP 2.2 source can be displayed at a time. If HDMI 1 and HDMI 2 are both being shown on the display at the same time, only HDMI 1 will support HDCP 2.2 content.

Note: DP OUT can only transmit the content from DP IN. It cannot transmit the content from OPS or any HDMI input.

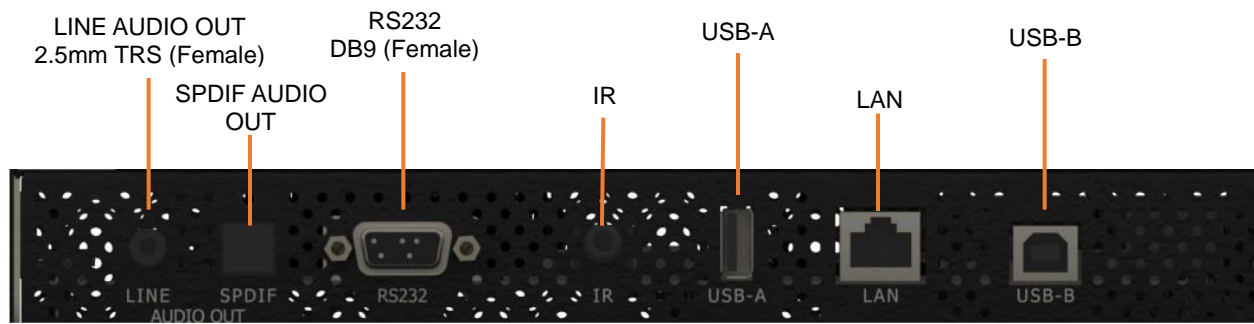

Installing the Display

Before installation, keep the following points in mind:

- The Planar UltraRes X Series displays are heavy. Be sure that the structure has adequate design to support the weight of each display to be mounted.
- Be sure the structure the unit will be mounted to is sufficiently engineered to support the total weight of the display and any peripheral equipment that may be attached to the display. Use properly sized hardware for the weight to be supported as well as suited to the type of structure to which the mounts will be attached.
- If the display is a touch model, it is important the touch frame is not used to lift or support the display or touch performance may be compromised.
- Any mount must be secured per the manufacturer's recommendations to a structure that has been properly designed to hold the weight of all components that will be attached. Additionally, proper hardware engineered to be used in conjunction with the structure material and able to support the weight of all components must be used.
- If the Planar® Profile Mounting System was ordered, a template will be part of the kit to assist in proper location of all mount components referencing the center point of the display.
- The Planar Profile Mounting System must be mounted to a solid flat surface.
- The Planar Profile Mounting System have common components among all models except for when mounting any URX75 in portrait orientation. The main hanging support bar will be different; however, the process for installing is the same.
- For touch model best performance, the display must be mounted in a vertical to slightly tilted back orientation. Displays tilted forward can cause touch beam interference from the glass bowing slightly away from the display and into the IR path.

8. Mounting with a VESA Mount

The Planar UltraRes X Series can be mounted with the Planar Profile Mounting System (see page 13) or with a VESA mount, available from Planar or other manufacturers.

If you purchased a VESA mount, you should have received a separate box with mounting supplies and an Installation manual. Follow these instructions carefully.

Keep in mind the following general installation guidelines:

- Screw length is crucial and will vary depending on the type of mount you use. Total screw length will include the penetration length plus the length required by the type of VESA mount in use.
- Mount spacers may be required to accommodate the protruding back panel of the OPS slot.

Caution: Screws not sized to the depth specified can result in inadequate mounting strength or damage to the internal components in the display. To prevent injury, this device must be securely attached to the wall in accordance with the installation instructions supplied with the mount. The mount must be secured to the Planar UltraRes X Series display using the four M8-1.25 VESA mounting locations, and 10mm -15mm thread engagement is required for secure mounting. Select the correct screw/spacer combination for the mount.

- Prior to installation, make sure you know where all of the mounting points are located.
- Follow all safety precautions outlined in the VESA Installation manual.
- Verify the parts received with the list shown in the VESA Installation manual.

9. Installing the Optional Planar Profile Mounting System

For Planar Profile kits, a template has been supplied in the kit to simplify installation of the Planar Profile components. If the template has been misplaced or lost, refer to the product outline drawing for pertinent dimensions on the location of the Planar Profile mount component locations. The following steps describe the use of the template to locate components.

Note: The mounting instructions below show a 75" landscape display; however, any size is similar in procedure.

1. Determine and mark a vertical and horizontal line of the center display of the unit. For mount location verification, it is optional to continue the line or mark the left and right most edge of the display as well as the top.

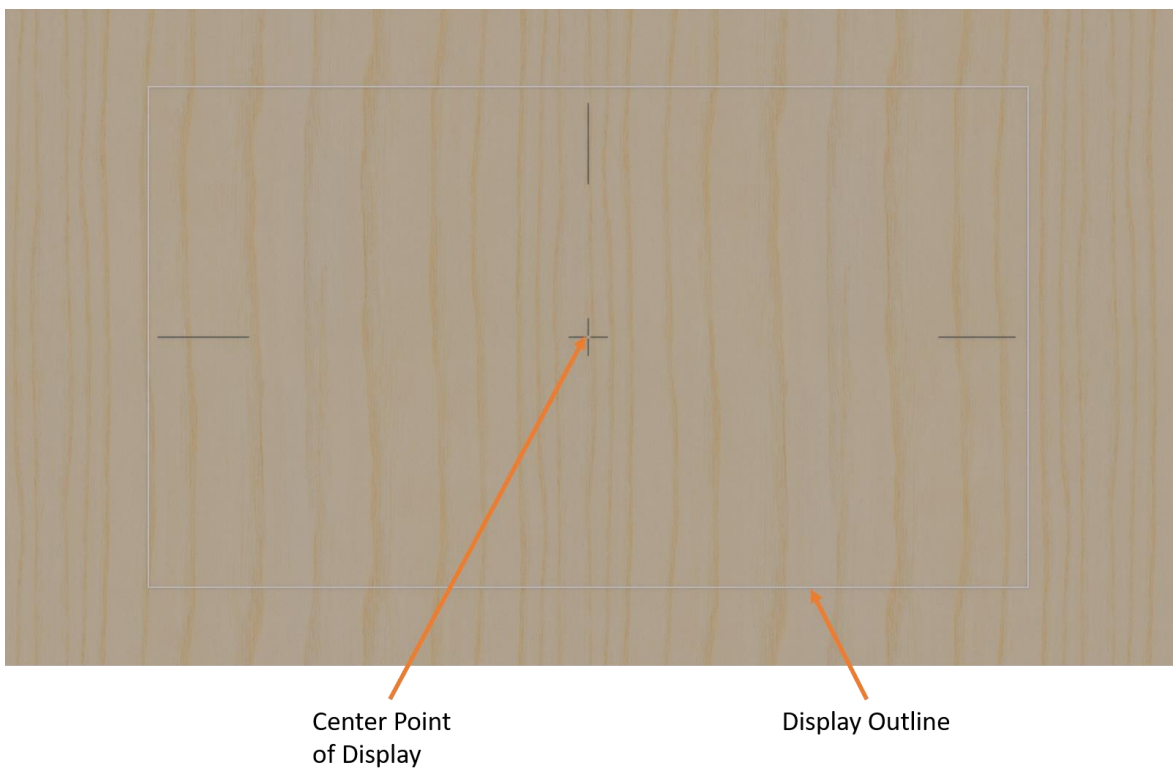

- Using the dimensions on the template for the model being installed, mark the location of the upper-left mount position.

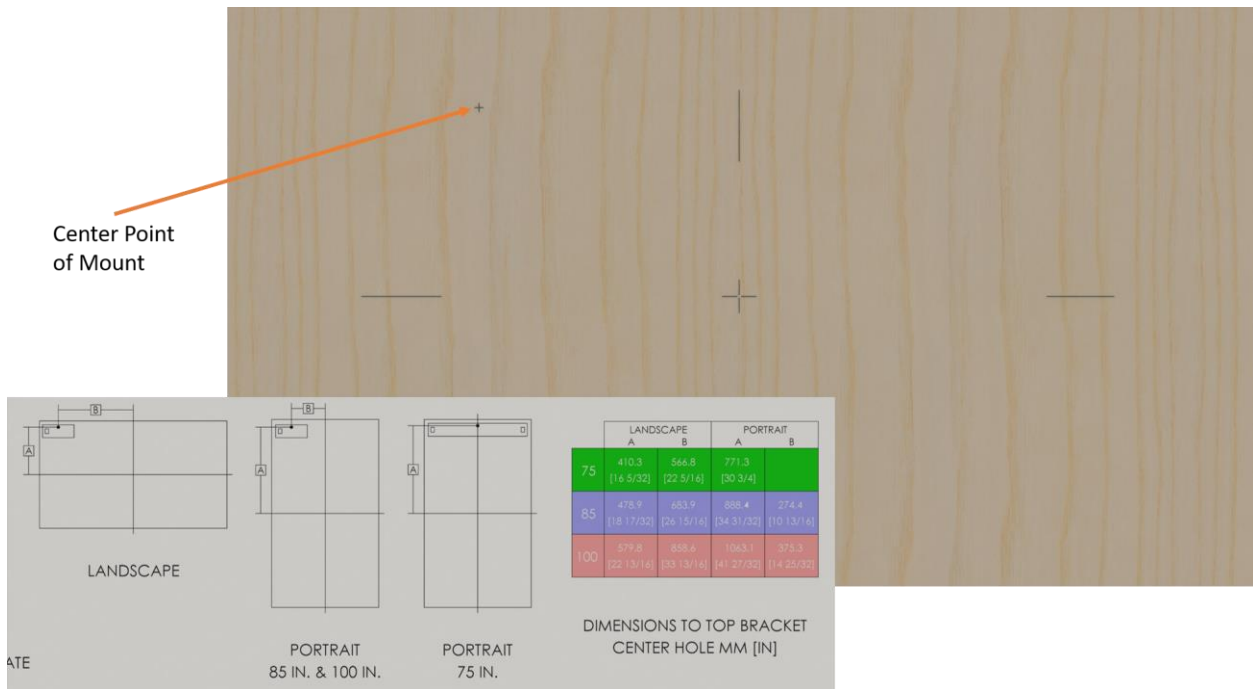

- Install the left mount as indicated. The marked position is the location of the center hole on the mount.



- Level and install the main support screws. At minimum, two pieces of mounting hardware must be used on a single hanging mount component.



Note: When mounting, it is best practice to install hardware on either side of the hook to distribute the load both vertically and horizontally. Failure to do this may result in the panel flexing outward from the wall.

- Place the opening in the template over the hook of the installed mount so it is resting against the back of the mount, level, and slightly pull to the right to find the labeled hole position for the model and orientation of the display being mounted. Mark this location on the structure.

Note: The “V” notch in the template labeled for the model being installed can be used to verify the center marks made in step 1 are correct. A slight variation in this location is okay due to being able to slightly move the display horizontally once installed.



6. Remove the template and install the right mount in the location marked. The marked position is again the location of the center hole on the mount.
7. Level and install the main support screws. At minimum, two pieces of mounting hardware must be used on a single hanging mount component.



8. Place template vertically on either hook of the installed hanging mounts.



9. Plumb the template, slightly pull down and mark the three locations of the service mounts attachment locations for the model product being installed.

Note: The “V” notch in the template labeled for the model being installed can be used to verify the center marks made in step 1 are correct.

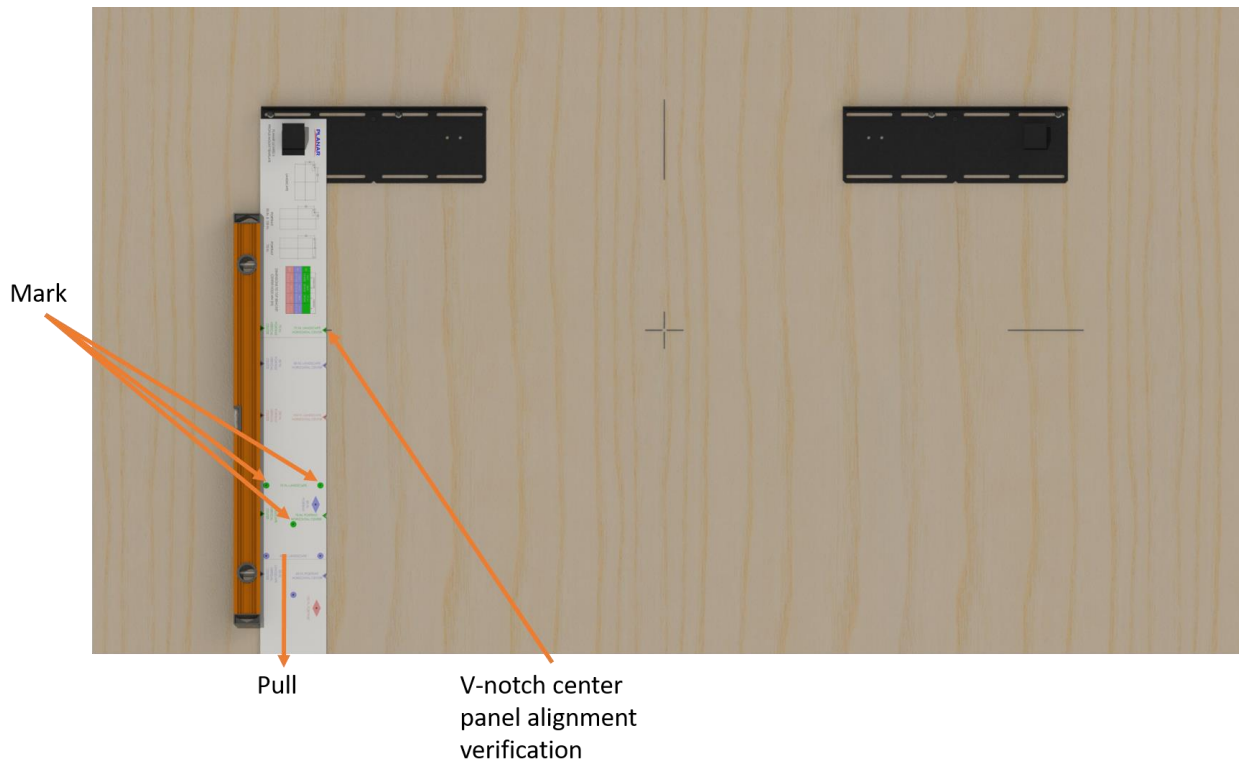

10. Remove the template and repeat steps 8-9 for the other hanging mount.

11. Install the service mounts where marked.

Note: Two of the side mount attachment locations are slotted, in case when the panel is installed there needs to be a slight vertical adjustment in location.

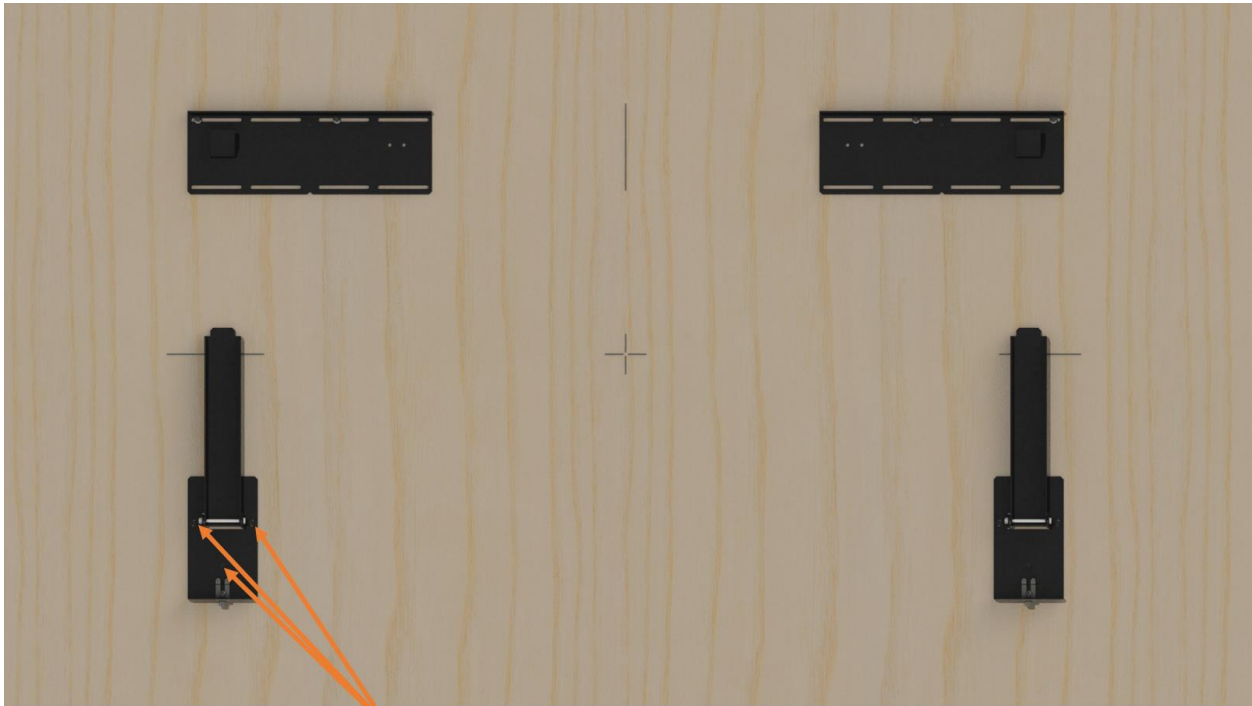

Install Hardware

12. Release the locking tabs on the service mounts so they do not interfere with the display installation.



Unscrew and
let hang free

13. Hang the display on the mounting hooks where circled.

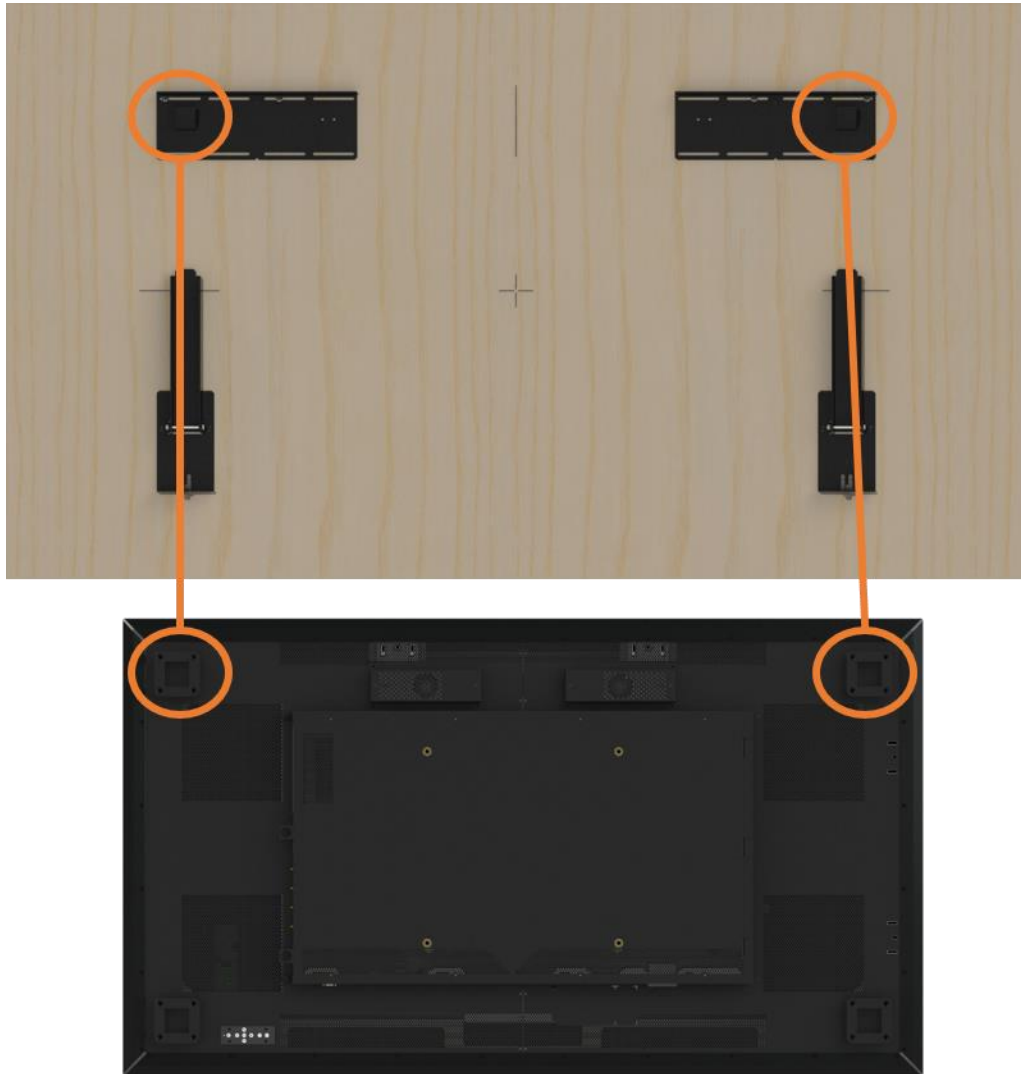

Note: It is recommended that capable lift equipment be used to install the displays due to their weight. Planar provides lifting eyes (sold separately) for use with capable equipment (see “Using the Lifting Eyes” on page 25). If mechanical equipment is unavailable or impractical, Planar supplies lifting straps for use with lifting displays.

Caution: Displays may be very heavy, make sure enough resources are available to lift displays into place on the mount structure.

14. If the panel interferes with the locking tabs or the locking tabs are unable to engage, adjust the vertical position of the service mounts to accommodate. Remove the center screw to make this adjustment.
15. Once the display is able to lay flat and the locking tabs engage with the bottom display mount brackets, the locking tabs may be re-tightened to the service mounts to keep the panel from being pulled out.

16. To gain easy access to the rear of the display to connect cables, use the kickstands on the service mounts. Rotate the kickstand down after pulling the panel out. The kickstands will nest into the lower panel mount brackets.

Caution: Use both kickstands. Using only one will cause stresses in the panel that can cause damage.



9.1 Using the Lifting Eyes

1. Slide the eye assemblies upward into the slots where shown. There will be a click when they are fully seated.



2. Securely attach the lift mechanism and note the requirements below for spacing. For a spreader bar application, the bar should be a minimum of 200mm (7.9") from the edge of the display. For a single point lifting application, the angle of the line between the eyehooks and the display must be 45° or greater.

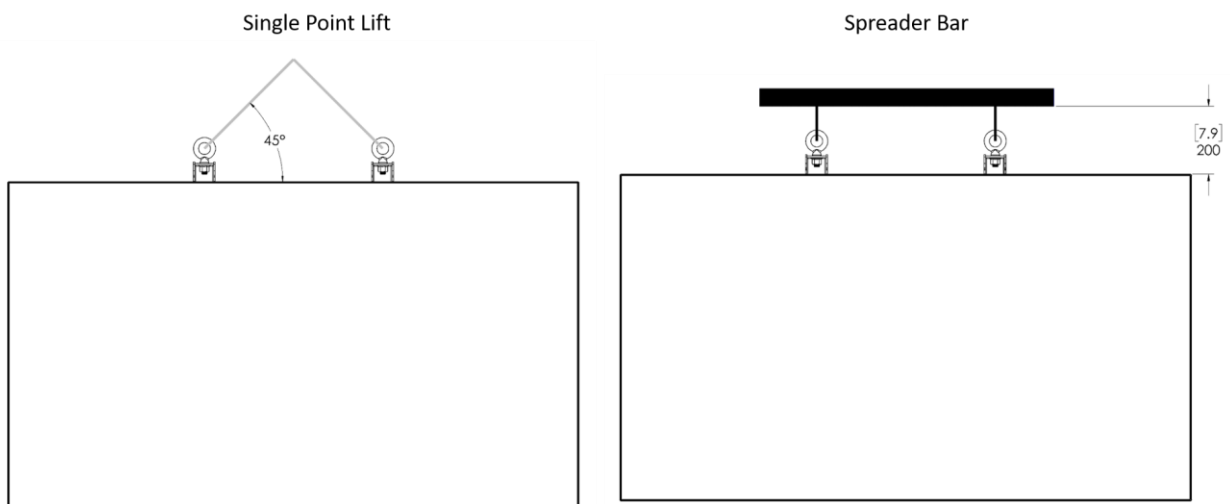

3. Lift the panel into place.
4. Remove the lift mechanism attached to the lifting eyes.

5. Remove the lifting eyes by pulling out the retaining pin, allowing the lifting eyes to slide down.

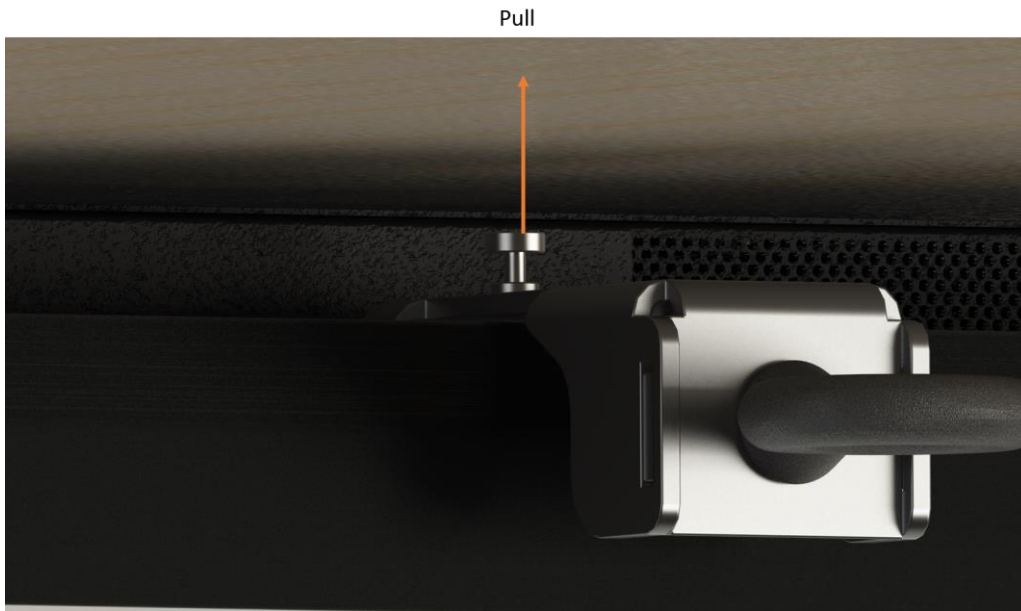

Note: To completely remove, it may be required to slide the lifting eyes horizontally past the hanging mounts after disengaging from the panel.

9.2 Cable Length Recommendations

Cable length performance may vary between different cables and sources. The recommended maximum DisplayPort length is 3m for DisplayPort 1.2 and 5m for DisplayPort 1.1. HDMI cable length is recommended as follows:

- 4K @ 50/60Hz: 5m maximum
- 4K @ 24/25/30Hz: 15m maximum
- 1080p @ 60Hz and lower resolutions: 30m maximum

10. Installing OPS Expansion (Optional)

Planar UltraRes X Series displays are equipped with an expansion slot that supports the Intel® Open Pluggable Specification (OPS). The slot will support OPS devices such as PC's, SDI modules, HDBaseT receivers, etc.

To install an OPS device, remove the protective cover on the display and slide the device firmly into position. When installed, the OPS device will be connected internally to the display. No external video or power cables are required.

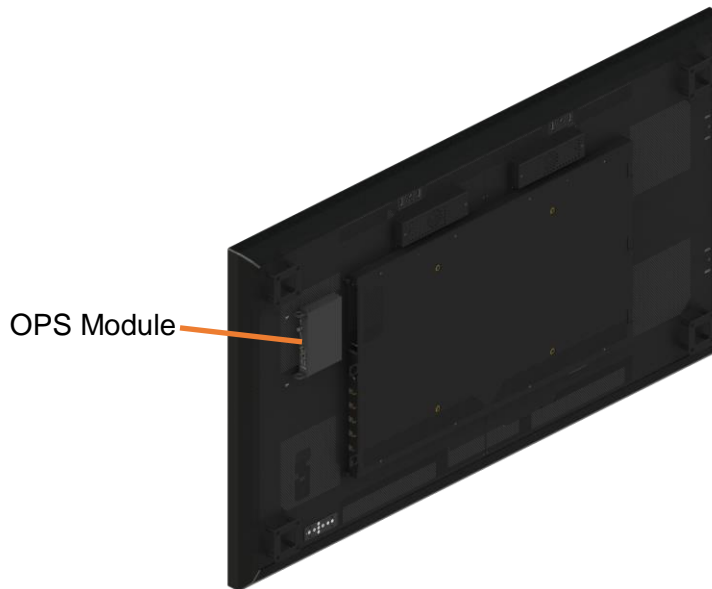

Operating the Display

11. OSD Keypad

The OSD keypad is located on the rear of the display.

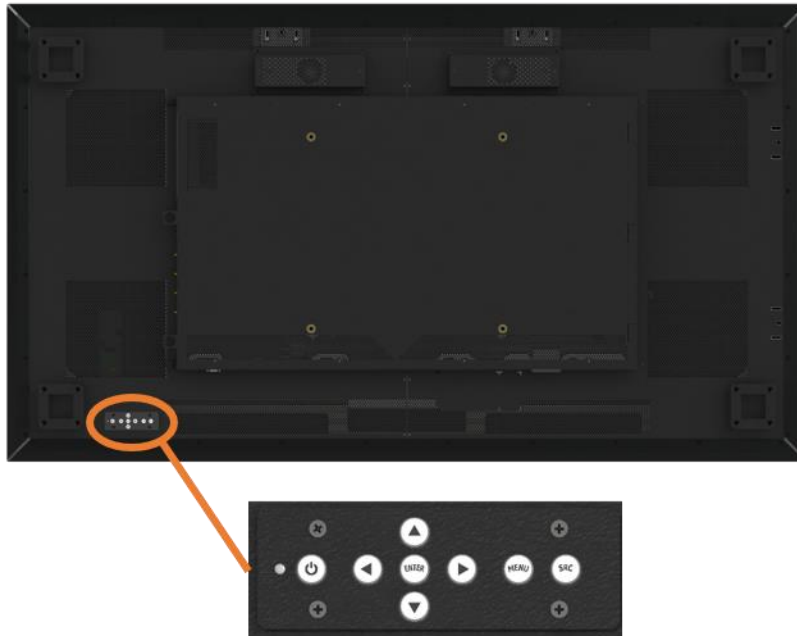

OSD Keypad Buttons

Key	Descriptions
Power	Power on/Power off
◀	Menu Left/Decrease value
▶	Menu Right/Increase value
▲	Menu Up/Increase volume
▼	Menu Down/Decrease volume
Menu/Exit	Menu/Exit
Source	Source selection (toggle)

12. Remote Control Receiver

The remote control receiver is located near the keypad on the rear of the display. Use the IR extender cable for operating the remote from the front of the display.



13. LED Indicators

The LED indicator light is located on the rear of the display near the keypad. The following table explains what the different colors and blink patterns mean.

LED On

Power Status	Condition
Green	Standby mode
Amber	Full power mode
Green Flashing (1 Hz)	AC power on
Green Flashing (0.5 Hz)	Powering on from standby
Green Flashing (5 Hz)	Firmware updating
Amber Flashing (5 Hz)	Power supply failure
Green and Amber	Firmware update failure

14. Using the Display in Portrait Mode

When using the display in the portrait position and looking at the rear of the display, it should be rotated according to the arrow stickers on the back of the display. This will allow for proper ventilation. Then select the OSD rotation of landscape or portrait on the OSD menu (MAIN MENU > ADVANCED SETTINGS > MENUS AND MESSAGES > OSD ROTATION).

For reference, the following list indicates the rotation direction of each display model when placed in portrait mode as viewed from the display side:

- URX75(-ERO)(-T): Clockwise
- URX85(-ERO)(-T): Clockwise
- URX100(-ERO)(-T): Clockwise

Caution: Failure to follow these instructions will void the warranty.

15. Using the Display in Flat or Tilted Orientation

The display is not recommended for use in flat orientation for tabletop, floor, or ceiling installations. LCD panels of this size are at risk of panel deflection, which can cause cosmetic sagging, brightness uniformity issues, a shortened life span, and malfunction of optional touch sensors. Installations where the display is tilted downward or upward at an angle may also be prone to these issues and are not recommended.

Note: Failure to follow these instructions will void the warranty.

16. Using the Remote Control

Below is a picture of the remote control and its corresponding Hex codes. See the following page for button descriptions and Hex codes.



17. IR Command Protocol

The Planar UltraRes X Series displays accept commands in the form of IR signals that conform to the NEC protocol. Each Planar UltraRes X Series remote control has an NEC control code associated with it. You can use these codes to program a third-party “universal” remote control to work with the Planar UltraRes X Series displays. These third-party products usually come with a computer software application for this purpose. For more information, consult the documentation provided with the remote control.

The IR control codes have the following characteristics:

- Each code consists of the following:
 - A leader pulse (a modulated pulse of 9 ms followed by a non-modulated pulse of 4.5 ms)
 - 16 address bits. The default address is 1785 (0x06F9, binary 00000110 11111001)
 - 16 data bits: eight (8) bits for the command followed by the logical inverse of the command
 - An end pulse (a modulated pulse of 0.56 ms, similar to the modulated pulse in the ‘0’ and ‘1’ bits). The end of the modulated pulse constitutes the end of the data transmission.
 - The carrier frequency is 38 kHz, with the modulated pulses having a 33% duty cycle.
 - Commands are sent at a maximum rate of 9 Hz.

For example, below is the NEC control code for the ON button of the Planar UltraRes X Series remote control (assuming the default address is used).

Hex	06	F9	01	FE
Binary	00000110	11111001	00000001	11111110
Function	Address Byte 1	Address Byte 2	Command	Command (Logical Inverse)
	1	2		

The following example shows the pulse train for this command.



Remote Control Button Name	Address	Data	NEC Data From Remote (Hex Code)	Description
ON	1785	1	0x06F901FE	Power on
OFF	1785	9	0x06F909F6	Power off
◀	1785	2	0x06F902FD	Not used
▶	1785	3	0x06F903FC	Not used
**	1785	6	0x06F906F9	Not used
PRESETS	1785	4	0x06F904FB	Opens the Presets menu
PRESET 1	1785	5	0x06F905FA	Applies Preset 1
PRESET 2	1785	7	0x06F907F8	Applies Preset 2
PRESET 3	1785	8	0x06F908F7	Applies Preset 3
PRESET 4	1785	10	0x06F90AF5	Applies Preset 4
1	1785	12	0x06F90CF3	Number button 1
2	1785	13	0x06F90DF2	Number button 2
3	1785	14	0x06F90EF1	Number button 3
4	1785	15	0x06F90FF0	Number button 4
5	1785	16	0x06F910EF	Number button 5
6	1785	17	0x06F911EE	Number button 6
7	1785	20	0x06F914EB	Number button 7
8	1785	25	0x06F919E6	Number button 8
9	1785	27	0x06F91BE4	Number button 9
0	1785	18	0x06F912ED	Number button 0
VOL +	1785	28	0x06F91CE3	Volume increase
VOL -	1785	33	0x06F921DE	Volume decrease
MUTE	1785	32	0x06F920DF	Audio mute
COLOR	1785	19	0x06F913EC	Not used

Remote Control Button Name	Address	Data	NEC Data From Remote (Hex Code)	Description
VIDEO WALL	1785	34	0x06F922DD	Opens the Tiling menu
MISC	1785	11	0x06F90BF4	Opens the Image Information menu
MENU	1785	21	0x06F915EA	Opens the menu
PREV	1785	22	0x06F916E9	Returns to the previous menu
ENTER	1785	23	0x06F917E8	Selects the current menu item
UP	1785	26	0x06F91AE5	Navigate up
LEFT	1785	29	0x06F91DE2	Navigate left
RIGHT	1785	31	0x06F91FE0	Navigate right
DOWN	1785	24	0x06F918E7	Navigate down
TOP	1785	30	0x06F91EE1	Selects the top line in the current menu
ZONE 1	1785	35	0x06F923DC	Selects the input for Zone 1
ZONE 2	1785	36	0x06F924DB	Selects the input for Zone 2
ZONE 3	1785	38	0x06F926D9	Selects the input for Zone 3
ZONE 4	1785	39	0x06F927D8	Selects the input for Zone 4
PIP MODE	1785	37	0x06F925DA	Selects the Multi-Source View setting
PIP SWAP	1785	40	0x06F928D7	Swaps the main and PIP windows
HDMI 1	1785	41	0x06F929D6	Selects HDMI 1 for the current zone
HDMI 2	1785	42	0x06F92AD5	Selects HDMI 2 for the current zone
HDMI 3	1785	43	0x06F92BD4	Selects HDMI 3 for the current zone
HDMI 4	1785	44	0x06F92CD3	Selects HDMI 4 for the current zone
DP	1785	45	0x06F92DD2	Selects DP for the current zone
DVI	1785	46	0x06F92ED1	Not used
VGA	1785	47	0x06F92FD0	Not used
OPS	1785	48	0x06F930CF	Selects OPS for the current zone

17.1 Locking the Keypad and IR Remote

You can lock the keypad and IR remote functionality on the display. To lock the keypad, go to Main Menu -> Advanced Settings -> System Settings and select Keypad Lock. To lock the IR remote, go to Main Menu -> Advanced Settings -> System Settings and select IR Remote Lock.

17.2 Unlocking the Keypad and IR Remote

To unlock the keypad, press the following keys on the keypad in the order listed: UP, UP, RIGHT, LEFT, DOWN. If the IR remote is unlocked, you can also unlock the keypad by using the IR remote to go to Main Menu -> Advanced Settings -> System Settings and uncheck Keypad Lock.

To unlock the IR remote, press the following keys on the IR remote in the order listed: UP, UP, RIGHT, LEFT, DOWN. If the keypad is unlocked, you can also unlock the IR remote by using the keypad to go to Main Menu -> Advanced Settings -> System Settings and uncheck IR Remote Lock.

17.3 Changing the IR Remote Code Set

The IR remote code set transmitted by the remote and accepted by the display can be configured. This is useful if there are multiple Planar displays and you would like each remote to work only with one of the displays. It can also be used if IR interference with another device, such as a DVD player, is occurring.

To change the IR code on the remote, use the following procedure:

1. Press and hold the CODE button on the remote control until the LED on the remote lights solid red (approximately five seconds).
2. Enter a new five-digit code between 00000 and 65535. Include leading zeros for codes with four or fewer digits; for example, enter 255 as 00255.
3. The LED turns off to confirm the code change. If you enter an invalid code, the LED flashes for three or four seconds. Try again, entering a valid code.

Note: The code must match the IR Remote ID Code setting. See page 66.

17.4 Turning the Display On

1. Insert the power cord into the display and into the power outlet.
2. Ensure the AC switch is set to “—“.
3. Press the ON button on the remote or the power button on the keypad.

17.5 Turning the Display Off

With the power on, press the OFF button on the remote or the power button on the keypad to put the LCD panel in a standby mode. To turn off power completely, turn the AC switch to “O” or disconnect the AC power cord from the power outlet.

Note: The display may automatically turn off the backlight or enter standby mode if no signal is present for a certain period of time. See the description of the Power Saving Mode setting on page 46 for more information.

17.6 Adjusting the Volume

1. Using the remote, press the vol + or vol - to increase or decrease the volume. You can also use the Up and Down keys on the remote and keypad to increase or decrease the volume.
2. Press the mute button to temporarily turn off all sound. To restore the sound, press the mute button again.

Note: The analog audio out is variable. S/PDIF is fixed.

17.7 Selecting Layouts and Input Sources

With Planar MediaPlex Plus Processing, you can show one source at a time or multiple sources simultaneously. Multiple layout options are available and can be selected from the Inputs and Views Menu (see page 36). Once a layout has been designated, you can assign sources to each of the zones in the layout. The selection of sources must be made one at a time by assigning a current zone. To select the current zone, you can navigate through the on-screen menu (see page 36). Alternatively, you can use the remote or keypad as described next.

Remote

Press the Zone 1, Zone 2, Zone 3, or Zone 4 buttons on the remote. After selecting the desired zone, you can press the source button (DP, HDMI 1, HDMI 2, HDMI 3, HDMI 4, or OPS). This action will also select the active audio source.

For example, to change Zone 3 to OPS, press the Zone 3 button and then press the OPS button.

Keypad

Press the SRC button. The input source will be toggled in the following order: HDMI 1, HDMI 2, HDMI 3, HDMI 4, DP, OPS).

Note: Sources will toggle through the current zone, or last zone to be modified. Current zones can only be re-assigned in the on-screen menu.

17.8 Navigating Through the Menus

1. With the power on, press MENU. The MAIN menu appears.

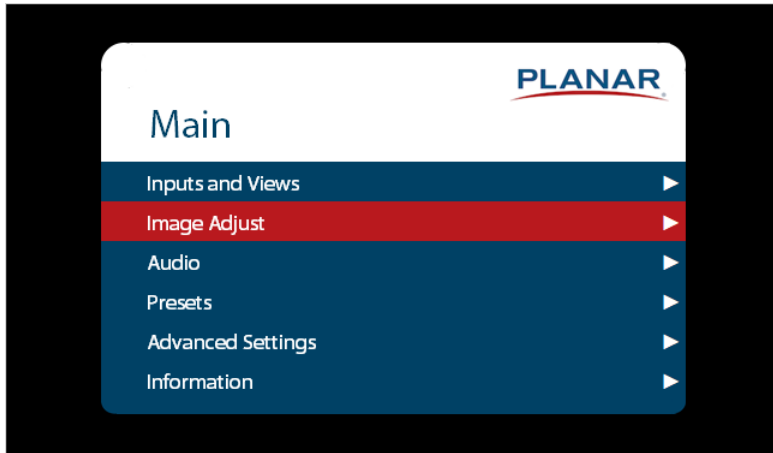

2. Within the menu, use ▲, ▼, ◀, ▶, and ENTER to navigate through the menus and adjust options.
3. Press PREV on the remote control, or MENU on the keypad, to return to the previous menu. To exit the menu system, press MENU on the remote control, or continue to press menu on the keypad until the main menu is reached.

18. Inputs and Views Menu

This menu shows how the sources will be laid out on the screen based on the current Multi-Source View and Advanced Layouts selections.

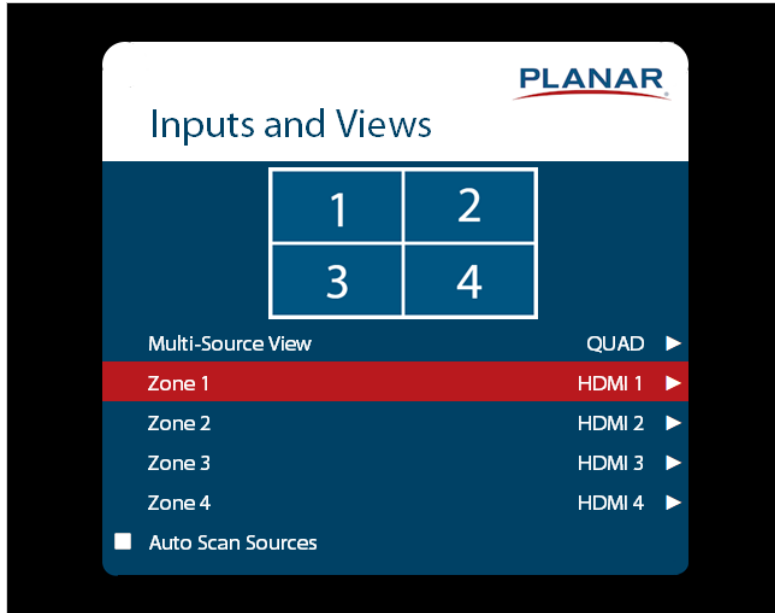

Multi-Source View

- Select the Multi-Source View mode
- **Options:** Single, Dual, Triple, Quad, PIP; Default: Single
- **Note:** For the Advanced Layouts submenu, refer to page 39.
- **Note:** You can only use 4K/60Hz in Single mode.

Zone 1

- Select the source displayed in Zone 1
- **Options:** HDMI 1, HDMI 2, HDMI 3, HDMI 4, DP, OPS; **Default:** HDMI 1
- **Note:** If HDMI1 was selected as another source, OPS cannot be selected. If OPS was selected as another source, HDMI1 cannot be selected.

Zone 2

- Select the source displayed in Zone 2
- **Options:** HDMI 1, HDMI 2, HDMI 3, HDMI 4, DP, OPS; **Default:** HDMI 2
- **Note:** If HDMI1 was selected as another source, OPS cannot be selected. If OPS was selected as another source, HDMI1 cannot be selected.

Zone 3

- Select the source displayed in Zone 3
- **Options:** HDMI 1, HDMI 2, HDMI 3, HDMI 4, DP, OPS; **Default:** HDMI 3
- **Note:** If HDMI1 was selected as another source, OPS cannot be selected. If OPS was selected as another source, HDMI1 cannot be selected.

Zone 4

- Select the source displayed in Zone 4
- **Options:** HDMI 1, HDMI 2, HDMI 3, HDMI 4, DP, OPS; **Default:** HDMI 4
- **Note:** If HDMI1 was selected as another source, OPS cannot be selected. If OPS was selected as another source, HDMI1 cannot be selected.

Auto Scan Sources

- Select whether the display will automatically scan for a valid source on any input or zone that does not have a source currently displayed. Scanning will begin on the currently selected source, and move sequentially through the inputs in the order listed below – stopping once a valid source is obtained.
- **Options:** HDMI 1, HDMI 2, HDMI 3, HDMI 4, DP, OPS

Advanced Layouts Submenu

This submenu defines the layouts for each multi-source view type.

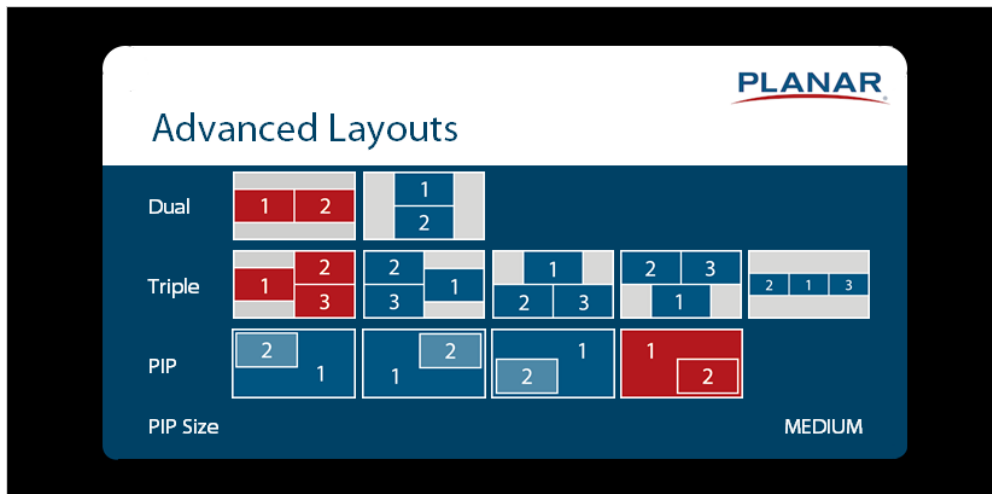

Dual

- Select from two dual source layout options. The layout in orange will be the active layout displayed when the Multi-Source View is set to Dual.

Triple

- Select from five triple source layout options. The layout in orange will be the active layout displayed when the Multi-Source View is set to Triple.

PIP

- Select from four PiP (Picture-in-Picture) layouts. The layout in orange will be the active layout displayed when the Multi-Source View is set to PiP.

PIP Size

- Select the size of the PiP (Picture-in-Picture) window.

18.1 Image Adjust Menu

This menu is used for making common image adjustments for the current zone.

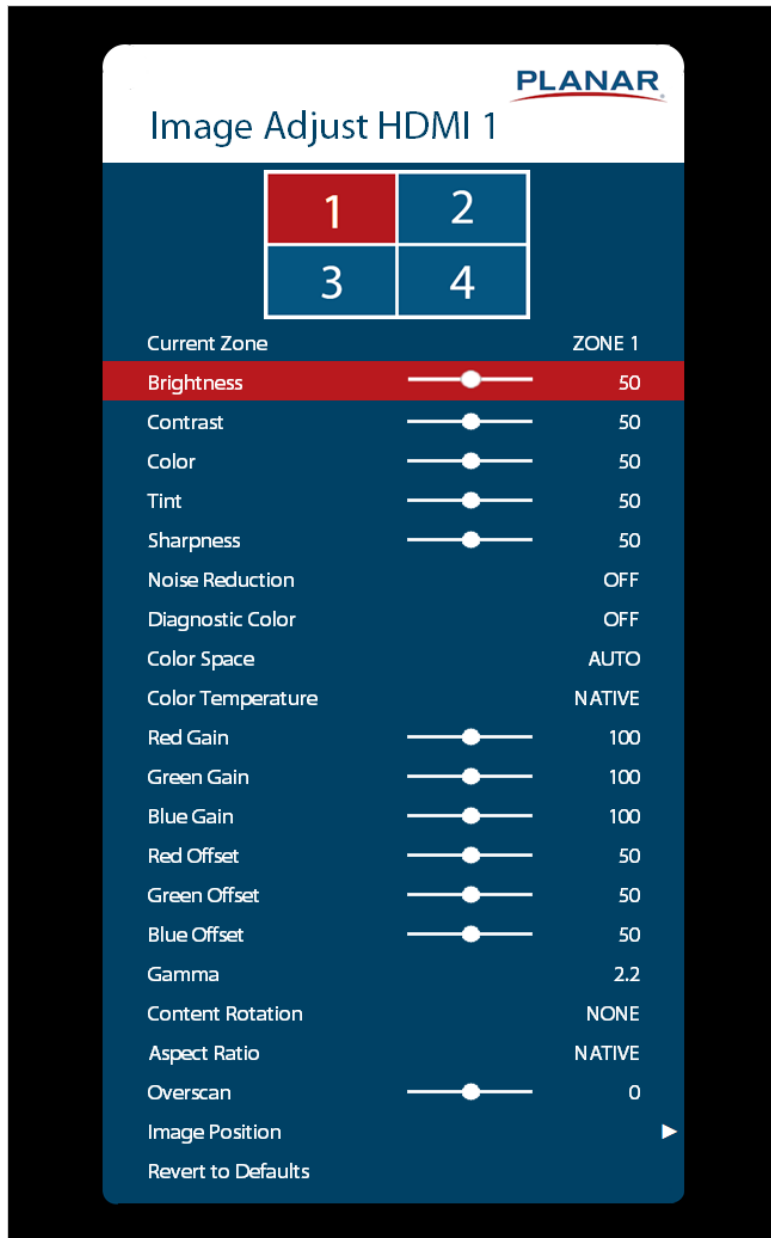

Current Zone

- The zone that is currently being adjusted. All of the settings in this menu are saved per input. The zone's corresponding input source is shown in the title bar, and the graphic beneath that shows which zone is being adjusted in the current Multi-Source View mode and Advanced Layout setting (if applicable).
- The current zone can be changed via the menu or by using the ZONE 1-4 keys on the remote control.
- **Note:** Changing the Current Zone setting via the ZONE 1-4 keys also changes the Audio Select setting.

Brightness

- Adjust the black level of the image
- **Range:** 0~100; **Default:** 50

Contrast

- Adjust the white level of the image
- **Range:** 0~100; **Default:** 50

Color

- Adjust the saturation of the image
- **Range:** 0~100; **Default:** 50

Tint

- Adjust the hue of the image
- **Range:** 0~100; **Default:** 50

Sharpness

- Adjust the sharpness of the image. Higher numbers are sharper
- **Range:** 0~10; **Default:** 5

Noise Reduction

- Turn on noise reduction processing
- **Options:** Off, Low, Medium, High; **Default:** Off

Diagnostic Color

- Set the image to monochrome. This setting is for use in adjustments to a test pattern and is not stored.
- **Options:** Off, Red, Green, Blue; **Default:** Off

Color Space

- Set the color space of the image
- **Options:** REC601, REC709, RGB, RGB Video, Auto; **Default:** Auto

Color Temperature

- Set the color temperature of the image
- **Options:** 3200K, 5500K, 6500K, 7500K, 9300K, Native; **Default:** Native

Red Gain

- Adjust the red gain of the image
- **Range:** 0~200; **Default:** 100

Green Gain

- Adjust the green gain of the image
- **Range:** 0~200; **Default:** 100

Blue Gain

- Adjust the blue gain of the image
- **Range:** 0~200; **Default:** 100

Red Offset

- Adjust the red offset of the image
- **Range:** 0~100; **Default:** 50

Green Offset

- Adjust the green offset of the image
- **Range:** 0~100; **Default:** 50

Blue Offset

- Adjust the blue offset of the image
- **Range:** 0~100; **Default:** 50

Gamma

- Set the gamma of the image
- **Options:** 1.5, 1.55, 1.6, 1.65, 1.7, 1.75, 1.8, 1.85, 1.9, 1.95, 2.0, 2.05, 2.1, 2.15, 2.2, 2.25, 2.3, 2.35, 2.4, 2.45, 2.5, 2.55, 2.6, 2.65, 2.7, 2.75, 2.8
- **Default:** 2.2

Content Rotation

- Rotate the image on the display
- **Options:** None, 90, 180, 270; **Default:** None

Aspect Ratio

- Set how the source is treated when the aspect ratio of the input is different than the aspect ratio of the zone it is in. If the image does not fill the zone completely, the extra margins are black.
- **Options:** Auto, 16:9, 4:3, Fill Screen, Native, Letterbox; **Default:** Auto

Overscan

- Set the percentage of the image to remove from each edge
- **Range:** 0~20; **Default:** 0

Image Position

- Move the image horizontally or vertically. The amount to move is measured in input pixels.
- **Range:** -1000~1000; **Default:** 0

Revert to Defaults

- Reset all settings in the Image Adjust menu to their factory defaults for the current zone only

18.2 Audio Menu

This menu enables you to make audio adjustments to the selected zone.

Note: Volume, Bass, Treble and Balance do not apply to the S/PDIF output.



Audio Select

- The zone that is currently being adjusted and whose audio is being played. The zone's corresponding input source is shown in the title bar.
- **Options:** Zone 1, Zone 2, Zone 3, Zone 4; **Default:** Zone 1
- **Note:** Changing the Audio Select setting via the ZONE 1-4 keys also changes the Current Zone setting.

Volume

- Set the volume of the audio
- **Range:** 0~100; **Default:** 50

Bass

- Set the bass level
- Range: 0~100; Default: 50
- **Note:** This setting applies only to the internal speakers, and cannot be adjusted for the Line Out connector.

Treble

- Set the treble level
- Range: 0~100; Default: 50
- **Note:** This setting applies only to the internal speakers, and cannot be adjusted for the Line Out connector.

Balance

- Set the audio balance
- **Range:** 0~100; **Default:** 50

Enable Internal Speakers

- Disable or enable the built-in speakers
- **Options:** On, Off; **Default:** On

Mute

- Mute or unmute the audio
- **Options:** On or Off; **Default:** Off

18.3 Presets Menu

This menu enables you to save Inputs and Views settings, Image Adjust settings, Audio settings, the Backlight Intensity setting, the Local Dimming setting, and Tiling settings. You can save up to 10 presets using this menu (more can be saved via the serial command interface). If a preset is saved, it will appear as “Preset 1”, “Preset 2”, and so on. If it is not saved, it will appear as “<Empty>”.



Recall

- Apply the setup from the selected preset
- **Range:** Preset 1~Preset 10

Save

- Save the current setup for later recall
- **Range:** Preset 1~Preset 10

Delete

- Delete the selected preset
- **Range:** Preset 1~Preset 10

18.4 Advanced Settings Menu

Panel Brightness Submenu



Intensity

- Set the intensity of the LCD backlight
- **Range:** 0~100; **Default:** 75

Local Dimming

- Turn on or off the local dimming function, if supported by the display
- **Options:** On, Off; **Default:** On
- **Note:** 75" and 85" models only

Power Submenu

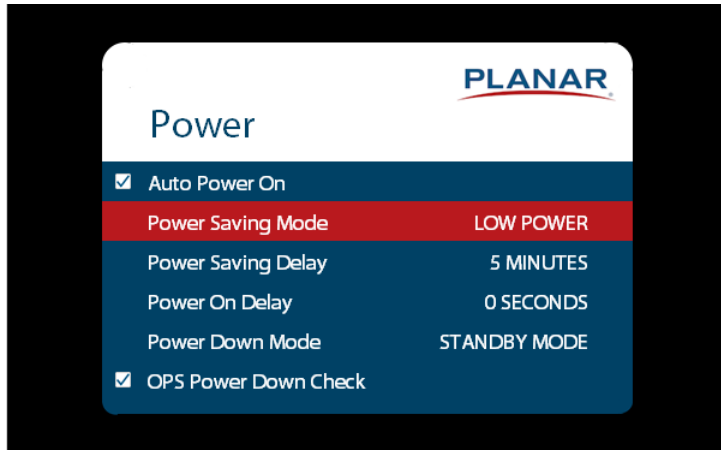

Auto Power On

- If set to On, the display will automatically leave standby after AC power is applied
- **Options:** On, Off; **Default:** Off

Power Saving Mode

- Set the action to take if there is no signal detected after the period of time specified by the **Power Saving Delay** setting
- **Options:** Disabled, Power Down, Wake on Signal; **Default:** Disabled
 - **Disabled:** Once powered on, the display will remain on even if no signal is present.
 - **Power Down:** The display will enter a standby state specified by the **Power Down Mode** setting.
 - **Wake On Signal:** The display will enter a standby sleep mode if no signal is detected. The display will wake when signal is restored.
 - **Note:** When signal is restored, a 10-15 second wait is typical to have an image displayed.
 - **Note:** The display must be allowed to enter sleep mode due to lack of signal for **Wake On Signal** to take effect. Sending an OFF command via Keypad, IR, CEC, RS232 or LAN will bypass **Wake On Signal** detection, and the display will enter the power state specified in the **Power Down Mode** setting.
 - **Note:** If **Auto Scan Sources** is enabled in the **Inputs and Views** menu, the display will sequentially scan all inputs before entering sleep mode. The display will leave sleep mode when a signal is detected on any input.
 - **Note:** If **Auto Scan Sources** is disabled in the **Inputs and Views** menu, the display leave sleep mode only when a signal is detected on the last selected input.
 - **Note:** When **Wake On Signal** is selected, the LAN port and **Remote Monitoring** web interface will remain accessible after the display enters sleep mode.

Power Saving Delay

- Sets the amount of time before initiating the standby state specified in **Power Saving Mode** when no signal is present
- **Options:** 1 Minute, 5 Minutes, 15 Minutes, 30 Minutes, 60 Minutes; **Default:** 5 Minutes

Power On Delay

- Sets the amount of time to delay between an ON command being received and the display leaving standby. This can be useful when multiple displays are on the same electrical circuit, and it is beneficial to avoid all displays leaving standby simultaneously, causing a large inrush of current.
- **Options:** 0-10 seconds, in 0.1 second increments; **Default:** 0 seconds

Power Down Mode

- Set the action to take when the display enters standby
- **Options:** Standby Mode, Networked Standby Mode, Fast Start; **Default:** Standby Mode
- **Standby Mode:** The lowest power standby setting. CEC, LAN, DB9 RS232, and USB communication are disabled. IR, Keypad connector will remain active.
- **Note:** To remove display from standby with the IR remote or keypad, IR Remote Lock or Keypad Lock must be disabled.
- **Networked Standby Mode:** The display will enter a low power standby state with LAN, DB9 RS232, USB and IR communications active.
- **Fast Start:** The display will enter a standby state with partially reduced power, allowing for 3-5 second wait between an ON command being sent, and image being displayed. IR, Keypad, CEC, LAN, DB9 RS232, and USB communication will remain active.

OPS Power Down Check

- When enabled, the system will wait for an indication from the OPS module that it has finished its power down sequence, before going into the standby state specified in **Power Down Mode**
- **Options:** Disable, Enable; **Default:** Enable

Network Submenu

The default static IP values are:

- IP Address: 192.168.12.12
- Subnet Mask: 255.255.255.0
- Default Gateway: 192.168.12.1

The static IP settings that you program will be used if a DHCP server cannot be found.

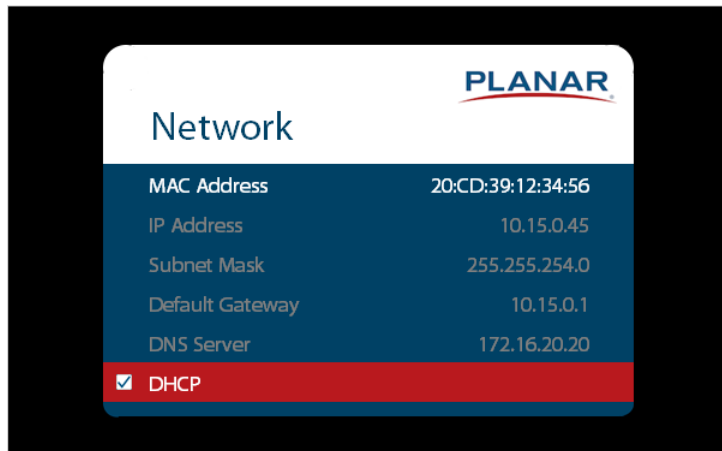

MAC Address

- The MAC address of the system

IP Address

- The current network address. You can use the number keys on the remote to enter this information.

Subnet Mask

- The current subnet mask. You can use the number keys on the remote to enter this information.

Default Gateway

- The current default gateway. You can use the number keys on the remote to enter this information.

DNS Server

- The current DNS server. You can use the number keys on the remote to enter this information.
- **Note:** The specified DNS server is used when Use Network Time is checked for the Set Date and Time setting.

DHCP

- Turn DHCP on or off
- **Options:** On, Off; **Default:** On

Menus and Messages Submenu

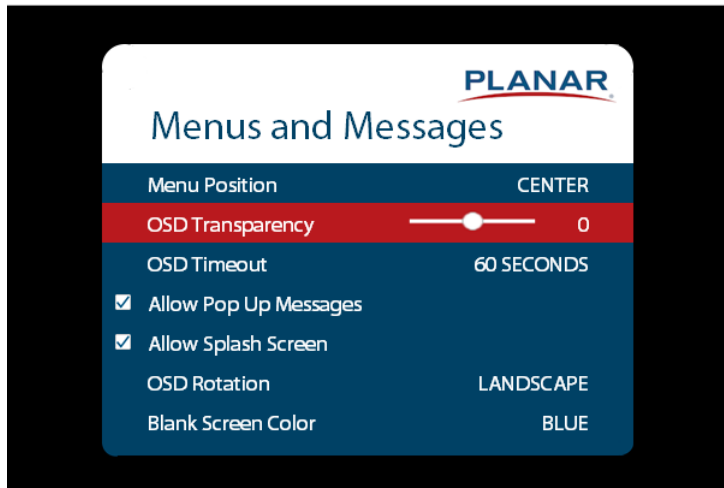

Menu Position

- Move the OSD menu to a different location on the screen
- **Options:** Center, Upper Left, Upper Right, Lower Left, Lower Right; **Default:** Center

OSD Transparency

- Set the transparency of the OSD so that the image behind it can be seen. Higher values mean greater transparency.
- **Range:** 0~5; **Default:** 0

OSD Timeout

- Set the amount of time in seconds since the last keypress before the OSD menu automatically closes. If set to Off, the menu never automatically closes.
- **Options:** Off, 10 Seconds, 30 Seconds, 60 Seconds, 120 Seconds, 240 Seconds; **Default:** 60 Seconds

Allow Pop Up Messages

- Suppress messages that pop up automatically. When set to No, the source status message and the volume slider bar will not be displayed.
- **Options:** Yes or No; **Default:** Yes

Allow Splash Screen

- Enable or disable the splash screen during startup
- **Options:** Enable or Disable; **Default:** Enable

OSD Rotation

- Rotate the OSD menu so that it is readable if the display is mounted in portrait orientation
- **Options:** Landscape or Portrait; **Default:** Landscape

Blank Screen Color

- Select the color to display when there is no signal in a zone
- **Options:** Black, White, Gray, Red, Green, Blue, Cyan, Magenta, Yellow
- **Default:** Black

Schedule Submenu

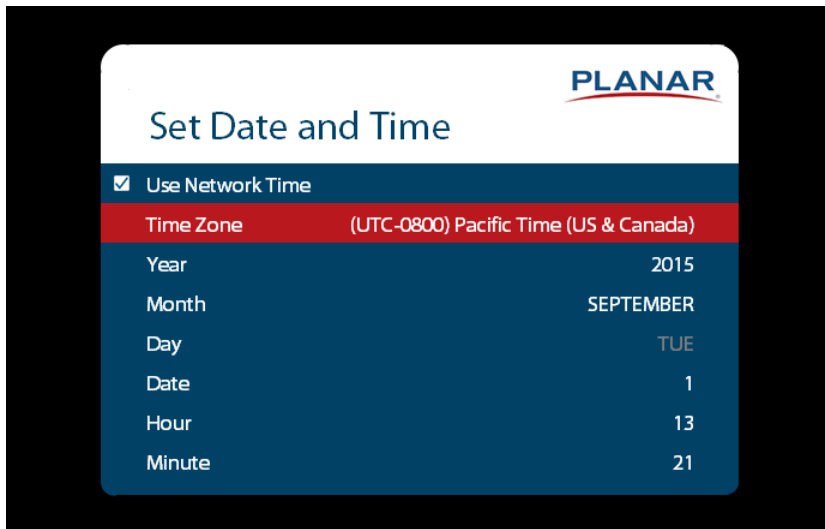
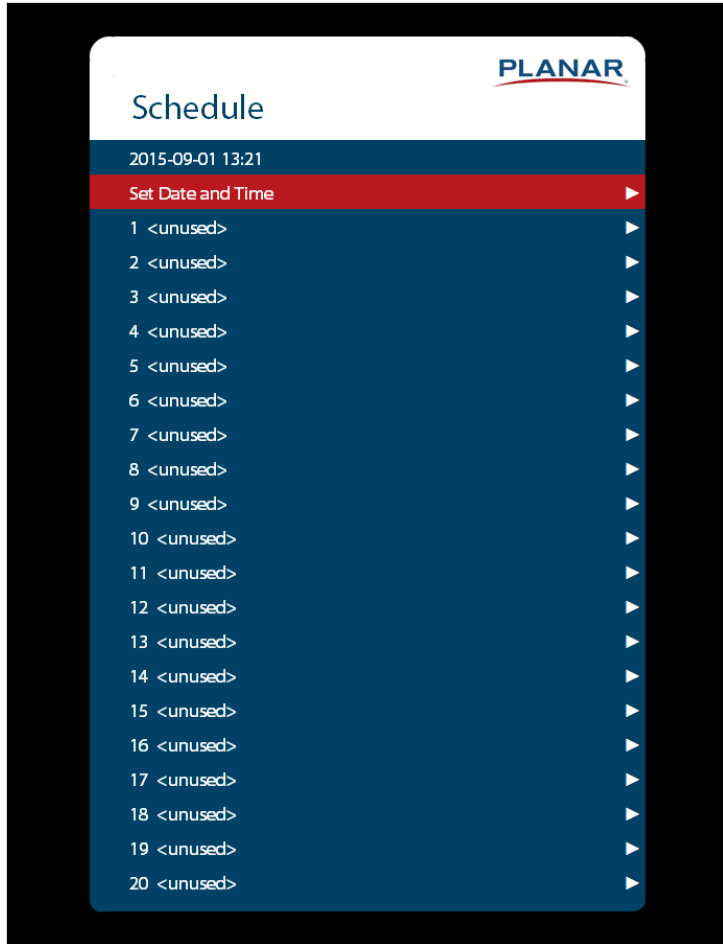

Set Date and Time

- Set the internal system clock. If Use Network Time is unchecked, you can set the following settings individually: Time Zone, Year, Month, Day, Date, Hour, and Minute.
- **Note:** If Use Network Time is checked and DHCP is unchecked, the display will be unable to obtain the network time unless a DNS server is programmed. This is done via the DNS Server setting in the Network menu or the serial command interface.

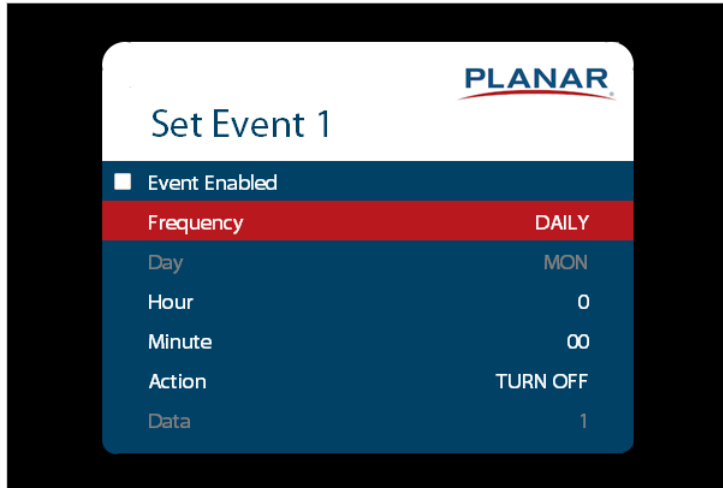

Set Event 1~Event 20

- **Event Enabled:** Turns on the event. If disabled, the settings are saved so that the event can be re-enabled.
- **Frequency:** The frequency of the event. Options are Daily, Weekly, Weekdays, Weekends.
- **Action:** The action to take for the event. Options are Turn On, Turn Off, Recall, Panel Brightness.
- **Data:** The preset to recall when the Action is set to Recall, or the backlight setting when the Action is set to Panel Brightness.

EDID Submenu

This menu specifies the EDID format and preferred timing for the selected connector.

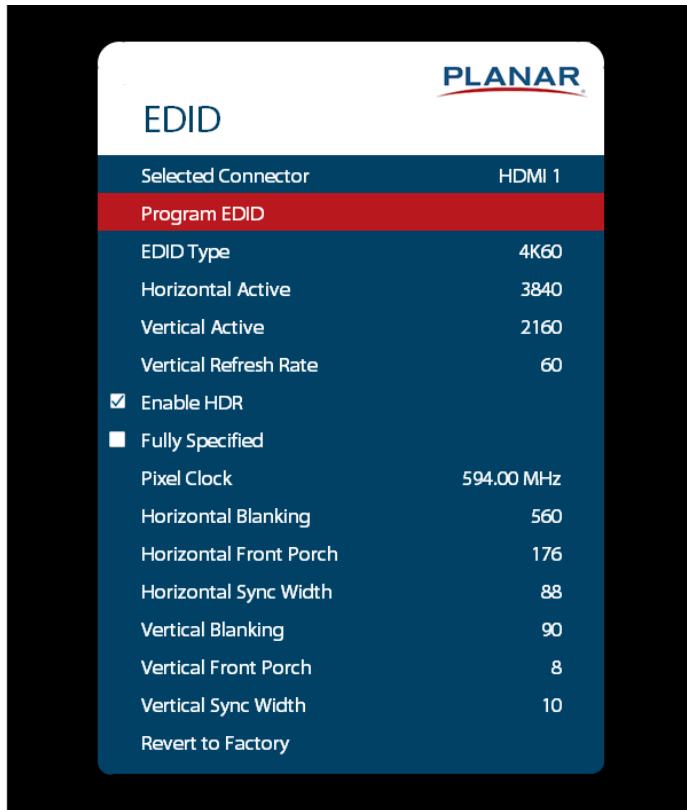

Selected Connector

- Set which connector is used
- **Options:** HDMI 1, HDMI 2, HDMI 3, HDMI 4, DP, OPS, All

Program EDID

- Program the EDID information for the selected connector based on the selections in the EDID submenu

EDID Type

- Set the EDID type to determine the base EDID used for the current connector:
- 4K60 selects an EDID format compliant with HDMI 2.0 and DP 1.2
- 4K30 selects an EDID format compliant with HDMI 1.4b and DP 1.1
- 1080P selects an EDID format compliant with HDMI 1.3 and DP 1.1
- **Options:** 4K60, 4K30, 1080P

Horizontal Active

- The number of active pixels in a line
- **Range:** 0~4095

Vertical Active

- The number of active lines in a field
- **Range:** 0~4095

Vertical Refresh Rate

- The number of fields per second rounded to the nearest Hz
- **Range:** 0~120

Enable HDR

- Indicate to the source that HDR content is supported
- **Options:** On, Off; **Default:** On
- **Note:** HDR compatible inputs are HDMI 1, HDMI 2 and the OPS.
- **Note:** Displaying HDR content requires an HDR compatible source and HDR encoded content.
- **Note:** HDR sources connected via HDMI require high speed (18Gbps) compatible cables.

Fully Specified

- Determine how the final detailed timing is calculated. If disabled, it is calculated based on Horizontal Active, Vertical Active, and Vertical Refresh Rate values. If enabled, it is calculated based on all of the EDID values except for Vertical Refresh Rate.
- **Options:** Disabled, Enabled
- **Note:** This setting should only be enabled by advanced users.

Pixel Clock

- The value of the pixel clock, in megahertz
- **Range:** 0~600.00, in 0.01 increments

Horizontal Blanking

- The number of non-active pixel clocks in a line
- **Range:** 0~1023

Horizontal Front Porch

- The number of pixel clocks in the horizontal front porch
- **Range:** 0~1023

Horizontal Sync Width

- The number of pixel clocks in the horizontal sync pulse
- **Range:** 0~255

Vertical Blanking

- The number of non-active lines in a field
- **Range:** 0~255

Vertical Front Porch

- The number of line times in the vertical front porch
- **Range:** 0~255

Vertical Sync Width

- The number of line times in the vertical sync
- **Range:** 0~255

Revert to Factory

- Reset the EDID type and timings to the default values for the selected connector

Advanced Color Submenu

This menu adjusts the color coordinates of the current zone. These controls are used by advanced installers to achieve exact color point targets on the display. In some cases, the target color coordinates may not be achievable. In this case, an asterisk (*) will appear next to the color coordinate value.

Note: The white color point should be adjusted before adjusting the other color points.

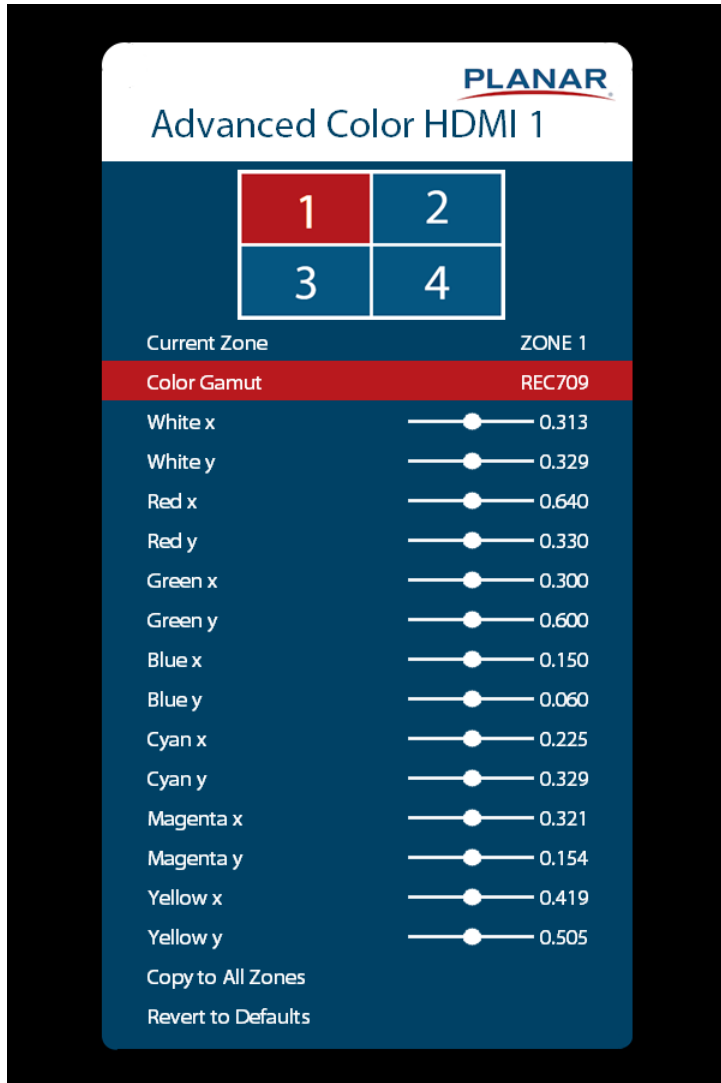

Current Zone

- The zone that is currently being adjusted. All of the settings in this menu are saved per zone, and all color coordinate values are also saved per Color Gamut setting. The zone's corresponding input source is shown in the title bar, and the graphic beneath that shows which zone is being adjusted in the current Multi-Source View mode and Advanced Layout setting (if applicable).

- The current zone can be changed via the menu or by using the ZONE 1-4 keys on the remote control.
- **Note:** Changing the Current Zone setting via the ZONE 1-4 keys also changes the Audio Select setting.

Color Gamut

- Select a preset Color Gamut of the image
- **Options:** REC709, SMPTE C, EBU, DCI, User, Auto, Disable. **Default:** Disable

White x

- Adjust the x coordinate of the white color point
- **Range:** 0.000-0.800

White y

- Adjust the y coordinate of the white color point
- **Range:** 0.000-0.800

Red x

- Adjust the x coordinate of the red color point
- **Range:** 0.000-0.800

Red y

- Adjust the y coordinate of the red color point
- **Range:** 0.000-0.800

Green x

- Adjust the x coordinate of the green color point
- **Range:** 0.000-0.800

Green y

- Adjust the y coordinate of the green color point
- **Range:** 0.000-0.800

Blue x

- Adjust the x coordinate of the blue color point
- **Range:** 0.000-0.800

Blue y

- Adjust the y coordinate of the blue color point
- **Range:** 0.000-0.800

Cyan x

- Adjust the x coordinate of the cyan color point
- **Range:** 0.000-0.800

Cyan y

- Adjust the y coordinate of the cyan color point
- **Range:** 0.000-0.800

Magenta x

- Adjust the x coordinate of the magenta color point
- **Range:** 0.000-0.800

Magenta y

- Adjust the y coordinate of the magenta color point
- **Range:** 0.000-0.800

Yellow x

- Adjust the x coordinate of the yellow color point
- **Range:** 0.000-0.800

Yellow y

- Adjust the y coordinate of the yellow color point
- **Range:** 0.000-0.800
- Copy to All Zones
- Copy the color coordinate settings for the current zone and the current Color Gamut setting to all other zones

Revert to Defaults

- Reset the color coordinate settings for the current zone and the current Color Gamut setting to their default values

Tiling Submenu

This menu contains controls for using multiple Planar UltraRes X Series displays in a tiled configuration. This is useful when trying to display one image across multiple displays. In addition to setting up the width and height of the tiled wall, each display must have its position within the tiled wall properly selected. Refer to the diagrams below for example setting values in a 3 x 4 tiled wall.

Note: When using the Content Rotation feature, the Tiling settings must be adjusted differently in order to display the image properly. Refer to the examples below.

Example 1: 0 Degree Rotation, Wall Width = 3, Wall Height = 4

Unit Row 1 Unit Column 1	Unit Row 1 Unit Column 2	Unit Row 1 Unit Column 3
Unit Row 2 Unit Column 1	Unit Row 2 Unit Column 2	Unit Row 2 Unit Column 3
Unit Row 3 Unit Column 1	Unit Row 3 Unit Column 2	Unit Row 3 Unit Column 3
Unit Row 4 Unit Column 1	Unit Row 4 Unit Column 2	Unit Row 4 Unit Column 3



Example 2: 180 Degree Rotation, Wall Width = 3, Wall Height = 4

Unit Row 4 Unit Column 3	Unit Row 4 Unit Column 2	Unit Row 4 Unit Column 1
Unit Row 3 Unit Column 3	Unit Row 3 Unit Column 2	Unit Row 3 Unit Column 1
Unit Row 2 Unit Column 3	Unit Row 2 Unit Column 2	Unit Row 2 Unit Column 1
Unit Row 1 Unit Column 3	Unit Row 1 Unit Column 2	Unit Row 1 Unit Column 1

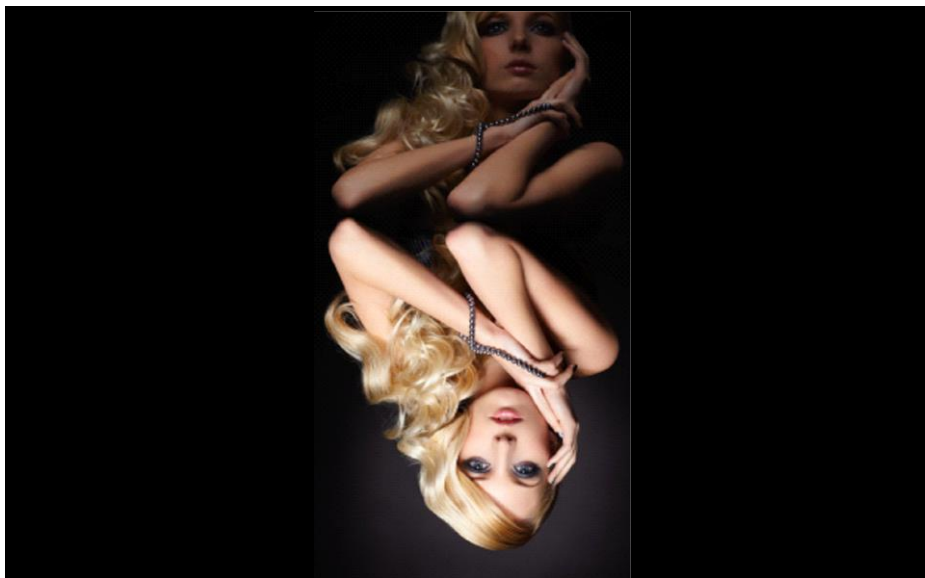

Example 3: 90 Degree Rotation, Wall Width = 4, Wall Height = 3

Unit Row 3 Unit Column 1	Unit Row 2 Unit Column 1	Unit Row 1 Unit Column 1
Unit Row 3 Unit Column 2	Unit Row 2 Unit Column 2	Unit Row 1 Unit Column 2
Unit Row 3 Unit Column 3	Unit Row 2 Unit Column 3	Unit Row 1 Unit Column 3
Unit Row 3 Unit Column 4	Unit Row 2 Unit Column 4	Unit Row 1 Unit Column 4



Example 4: 270 Degree Rotation, Wall Width = 4, Wall Height = 3

Unit Row 1 Unit Column 4	Unit Row 2 Unit Column 4	Unit Row 3 Unit Column 4
Unit Row 1 Unit Column 3	Unit Row 2 Unit Column 3	Unit Row 3 Unit Column 3
Unit Row 1 Unit Column 2	Unit Row 2 Unit Column 2	Unit Row 3 Unit Column 2
Unit Row 1 Unit Column 1	Unit Row 2 Unit Column 1	Unit Row 3 Unit Column 1



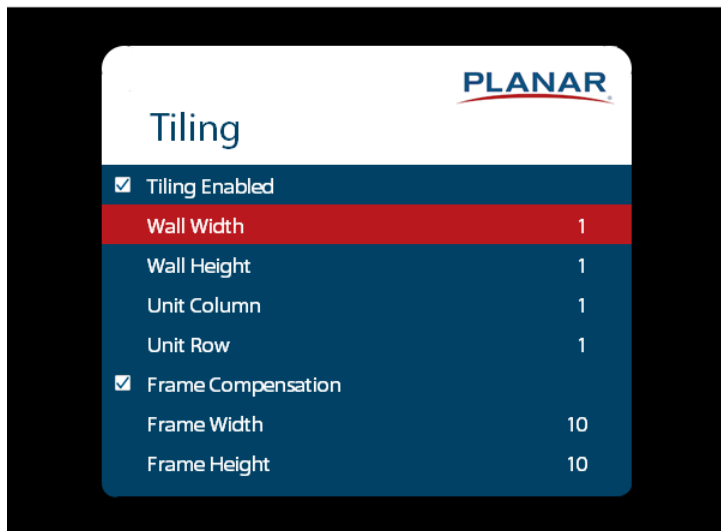

Tiling Enabled

- When enabled, the tiling parameters in the menu are used
- **Options:** Disable, Enable; **Default:** Disable

Wall Width, Wall Height

- Select the width and height of the tiled wall
- **Default:** Width=1, Height=1

Unit Column, Unit Row

- Selects the location of the current display within the tiled wall
- **Default:** Column=1, Row=1

Frame Compensation

- When enabled, the image is scaled to compensate for the width of the display's bezel, using the Frame Width and Frame Height parameters. See "Frame Compensation Examples" on page 62.
- **Options:** Disable, Enable; **Default:** Disable

Frame Width, Frame Height

- Selects how many lines/pixels are removed from the image to compensate for the display's bezel

Frame Compensation Examples

Below are examples with the Frame Compensation feature enabled (left) and disabled (right). Note that the eagle's eye is noticeably different when Frame Compensation is disabled.

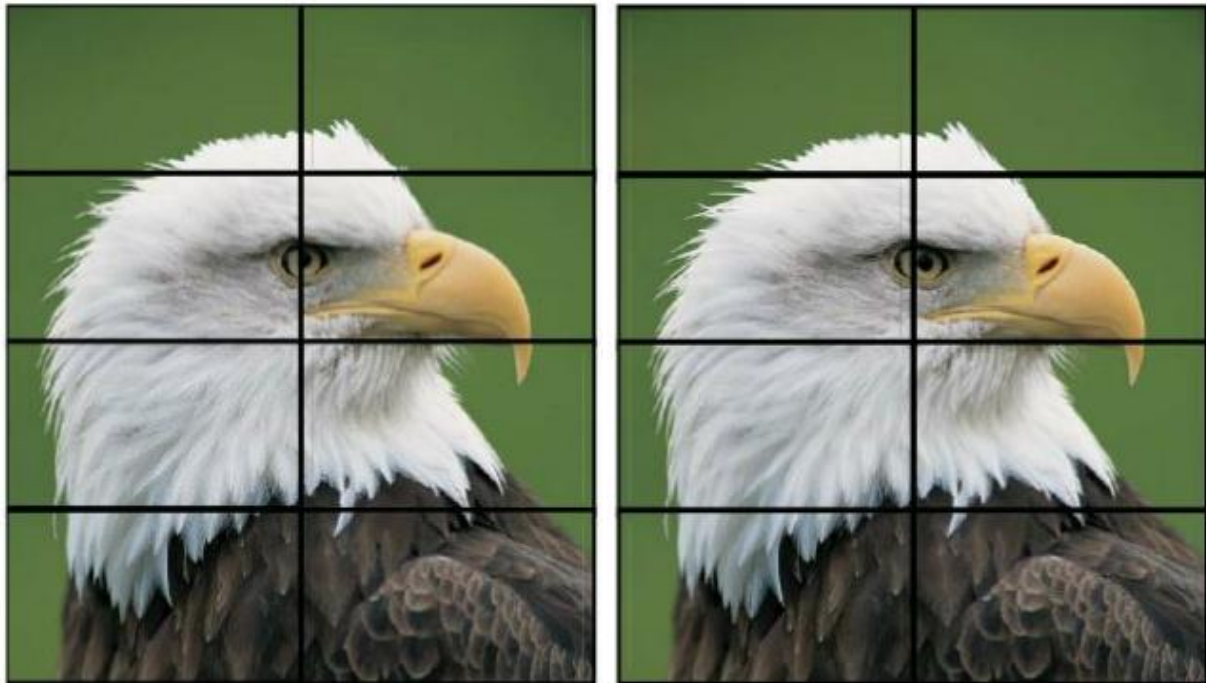

Test Patterns Submenu

This menu selects a test pattern to show on the display for diagnostic purposes.

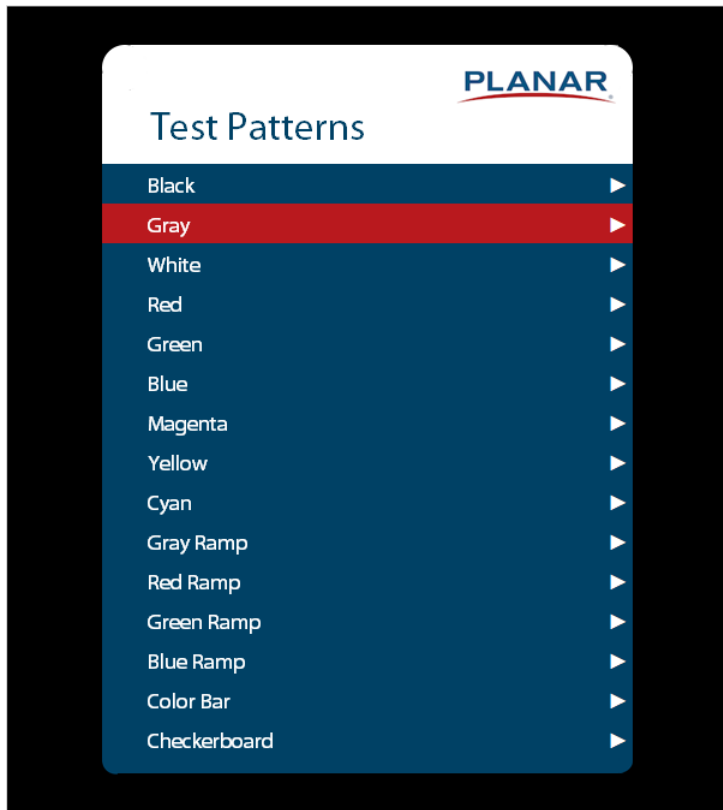

Test Patterns

- **Options:** Black, Gray, White, Red, Green, Blue, Magenta, Yellow, Cyan, Gray Ramp, Red Ramp, Blue Ramp, Color Bar, Checkerboard

System Settings Submenu

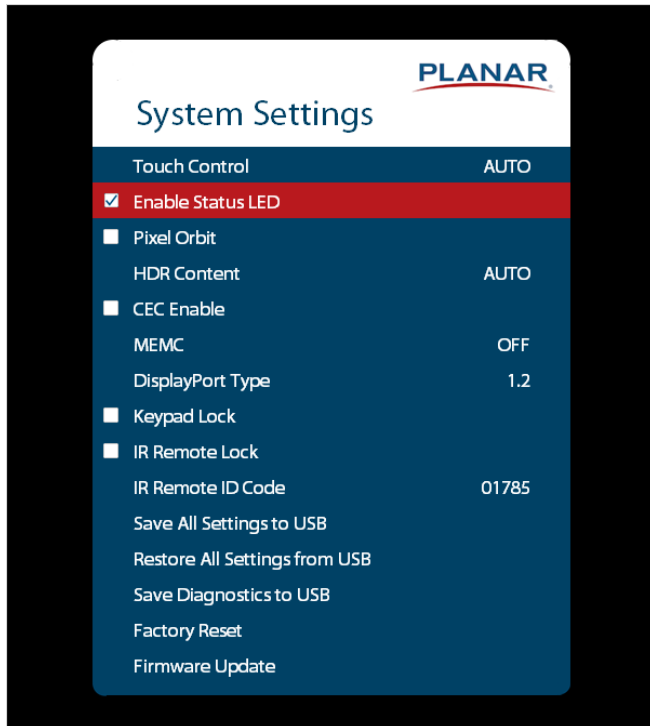

Touch Control

- Set where the USB commands from the touch panel is routed:
- OPS routes the touch USB commands to the OPS module
- External routes the touch USB command to the USB-B connector
- Auto routes the touch USB commands to the OPS module if the OPS source is selected; otherwise, they are connected to the USB-B connector

Enable Status LED

- When enabled, the status LEDs on the back of the display behave as indicated on page 28. When disabled, the status LEDs are always turned off.
- **Options:** Disable, Enable; **Default:** Enable

Pixel Orbit

- Create slight frame motion to help avoid image retention
- **Options:** Enable, Disable; **Default:** Disable

HDR Content

- Set the action to take when HDR content is received and displayed on HDMI 1, HDMI 2 and the OPS input
- **Options:** Auto, On, Off; **Default:** Auto
 - **Auto:** The display will adjust the image settings to conform to the HDR source metadata.
 - **On:** The display will force all content to be displayed in HDR mode.
 - **Note:** When viewing SDR content in this mode, the image quality will not have the correct appearance.

- **Off:** The display force all content to be displayed in SDR mode.
 - **Note:** When viewing HDR content in this mode, the image quality will not have the correct appearance.
 - **Note:** Due to the performance requirements of HDR, simultaneous viewing HDR and SDR content image appearance will be prioritized based on Zone 1 settings.

CEC Enable

- Enables HDMI-CEC (Consumer Electronics Control) with compatible external devices
- **Options:** On, Off; **Default:** Off

The CEC commands listed in the table below are implemented:

Command	Value
Image View On	0x04
Text View On	0x0D
Standby	0x36
Routing Change	0x80
Active Source	0x82
Give Physical Address	0x83
Report Physical Address	0x84
Request Active Source	0x85
Set Stream Path	0x86
Give Device Power Status	0x8F
Report Power Status	0x90
Inactive Source	0x9D
CEC Version	0x9E
Get CEC Version	0x9F
Give Features	0xA5
Report Features	0xA6

MEMC

- Enable motion estimation motion compensation (frame interpolation). This improves smoothness for fast motion video content.
- **Options:** Off, Low, Medium, High; **Default:** Off

DisplayPort Type

- Set the version of DisplayPort that is used by the system
- **Options:** 1.1, 1.2; **Default:** 1.2

Keypad Lock

- Lock or unlock the keypad. When it is enabled, all keypad presses will be ignored.
- **Options:** Enable, Disable; **Default:** Disable

IR Remote Lock

- Lock or unlock the remote control. When it is enabled, all remote control presses will be ignored.
- **Options:** Enable, Disable; **Default:** Disable

IR Remote ID Code

- Selects the IR remote code set accepted by the display
- **Options:** 00000-65535; **Default:** 01785

Save All Settings to USB

- Save all settings in the display to a USB flash drive. The saved file will be named Planar-settings.bin and will be saved in the root folder of the USB flash drive.
- **Note:** A USB flash drive must be inserted into the USB-A connector prior to using this feature. The USB flash drive must be formatted as FAT32. This feature will not work with the NTFS file system.

Restore All Settings from USB

- Restores all settings in the display from a USB flash drive. The settings file must be named Planar-settings.bin and must be located in the root folder of the USB flash drive.
- **Note:** A USB flash drive must be inserted into the USB-A connector prior to using this feature. The USB flash drive must be formatted as FAT32. This feature will not work with the NTFS file system.

Save Diagnostics to USB

- Save a diagnostic report to a USB flash drive to help Planar Technical Support troubleshoot any issues. The saved file will be named Planar-diagnostics.bin and will be saved in the root folder of the USB flash drive.
- **Note:** A USB flash drive must be inserted into the USB-A connector prior to using this feature. The USB flash drive must be formatted as FAT32. This feature will not work with the NTFS file system.

Factory Reset

- Return the saved settings in a system to their factory defaults

Firmware Update

- Update the firmware for the display. Refer to the instructions on the firmware release package for more information.

18.5 Information Menu



System Information Submenu

This menu displays version information for all programmable parts in the system. It also contains the model and serial number.

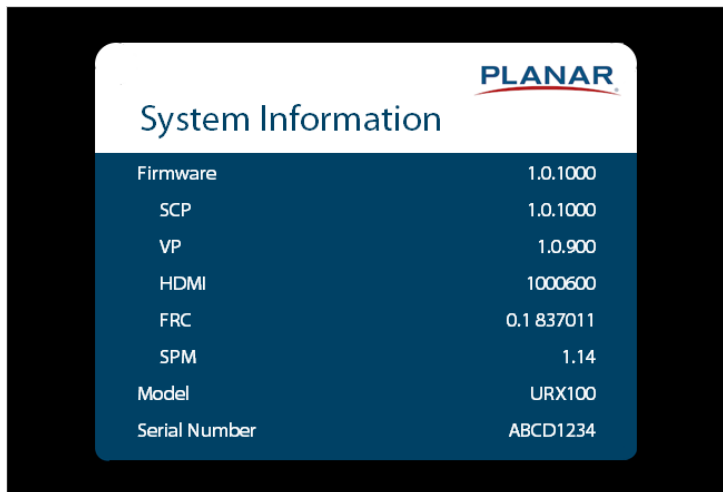
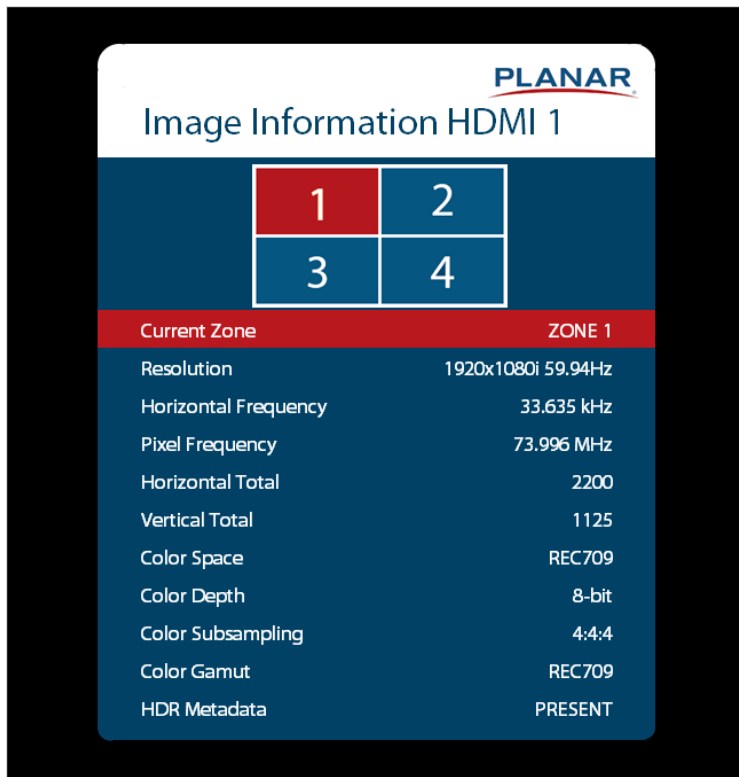

Image Information Submenu

This menu displays image details for the current zone. If more than one zone is available, you can change zones by setting the **Current Zone** option.



Error Log Submenu

This menu displays a chronological list of system errors that have occurred. For a list of possible errors, see "Error Codes" on page 101.

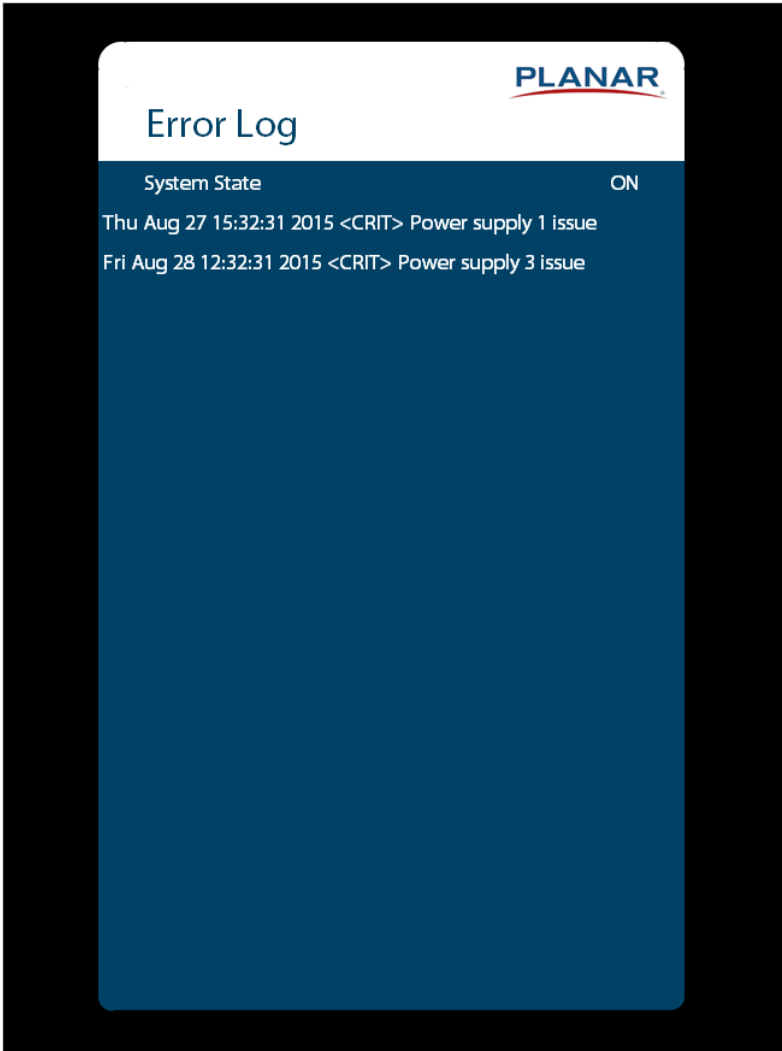

19. Using the Touch Screen

You can use the touch screen to control your Windows, Mac, or Linux operating system. The Planar UltraRes X Series is HID compliant, delivering up to 12 points of touch on both Windows and Linux without a driver. To achieve greater than 12 points of touch on a Planar UltraRes X Series Touch display, a driver will need to be installed on the operating system. Drivers for Windows and Linux can be found on <http://www.planar.com/support> and on the USB flash drive included with the display. Single touch only is supported for Mac operating systems. There is no driver required to enable Mac support.

Note: Ensure that you have installed the USB cable on the display to a computer.

Note: If an OPS PC is installed in the OPS slot, the OPS PC will automatically be connected internally to the touch system. The touch functionality is configurable via the Touch Control setting.

19.1 Touchscreen MultiTouch Driver Installation

1. With the PC on, plug in the USB memory stick to the USB port on your PC.
2. Locate and open the USB drive.
3. Double-click on the “mt_driver_kit [xxxxxx].exe” to install the driver.
4. Follow installation prompts until driver installation is complete.

Once driver installation is complete, the touchscreen is ready for use.

19.2 Touchscreen (PQLabs) MultiTouch Platform Content

The PQLabs Software is used for troubleshooting and calibration. The different menus are described below.

1. On the PC, select the Start menu, All Programs and then PQLabs Software.
2. Click on “MultiTouch Platform” to open the PQLabs MultiTouch Platform window.

Touchscreen Information

- Serial Number: Displays the serial number of the connected touchscreen.
- Firmware Version: Displays the firmware version of the touchscreen selected under the “Serial Number” dropdown menu.
- Touch Points: Displays the number of touch points for which the touchscreen is capable.
- Status: Displays the current status of the touchscreen.

Calibration

- Calibration: Starts a 4-point calibration of the touchscreen. Perform the programmed touchscreen calibration process. At the conclusion of the calibration routine your touchscreen device is ready to use and will perform with accurately positioned touch points.
- Reset Calibration: Resets calibration to factory default settings.

Utility

- Diagnose: Starts the “MultiTouchDoctor” program. This can be used to troubleshoot issues with the touchscreen.

Options

- Default settings on options have the following programs enabled: Tuio Support, Flash Tuio Support, Handwriting Optimization, Enable Windows Native Touch, Enable Mouse/Keyboard Simulation, and Launch When Windows Starts Up.
- Flexible Scan Rate is at a default setting.

19.3 Uninstalling the MultiTouch Driver

1. On the PC, select the **Start** menu, **All Programs** and the **PQLabs Software**.
2. Click on the MultiTouch Driver.
3. Select the Uninstall option.

Planar UltraRes X Series Remote Monitoring Software

Planar UltraRes X Series Remote Monitoring is a software tool that displays information about the display via a web browser. It is used primarily to access the settings in the OSD as well as provides some additional features.

20. Remote Monitoring Home

Launch a web browser. Enter the IP address shown in the Network menu (see page 48 settings). If successful, you should see the Remote Monitoring System Information page.

21. Remote Monitoring System Information

This page displays version information for all programmable parts in the system. It also contains the model and serial number.

For the OSD equivalent, refer to "System Settings Submenu" on page 64.

The screenshot displays the 'System Information' page for a Planar URX85 monitor. The page is divided into three main sections: Summary, Product Information, and Version Information. The Summary section lists system state (ON), multi-source view (SINGLE), audio input (DP), volume (1), mute (OFF), pattern/OSD on screen (No), and network IP address (10.15.0.81). The Product Information section shows the model (URX85) and serial number. The Version Information section lists firmware (3.0.1352), SCP (3.0.1352), VP (3.0.1263), and HDMI (01002100). The left sidebar contains navigation options: Admin, System Information, Inputs and Views, Audio, Presets, Advanced, Panel Brightness and Power, Notifications, System Settings, and Access Control. The Planar logo is visible in the top right corner.

System Information	
Summary	
System State:	ON
Multi-Source View:	SINGLE
Audio Input:	DP
Volume:	1
Mute:	OFF
Pattern/OSD On Screen:	No
Network IP Address:	10.15.0.81
Product Information	
Model:	URX85
Serial:	
Version Information	
Firmware:	3.0.1352
SCP:	3.0.1352
VP:	3.0.1263
HDMI:	01002100

22. Remote Monitoring Inputs and Views

This page shows how the sources will be laid out on the screen based on the current Multi-Source View and Advanced Layouts selections.

For the OSD equivalent, refer to "Inputs and Views Menu" on page 38.

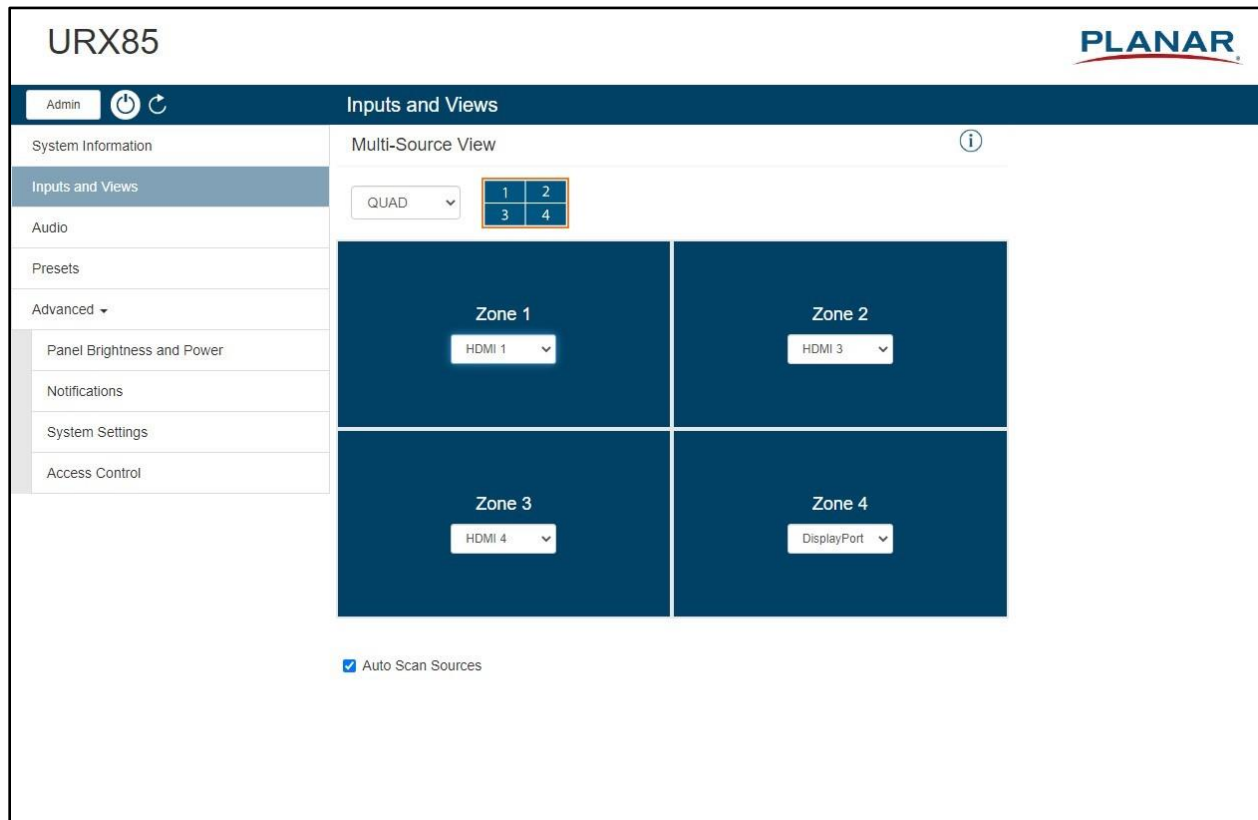

23. Remote Monitoring Audio

This page enables you to make audio adjustments to the selected zone.

Note: Volume, Bass, Treble and Balance do not apply to the S/PDIF output.

For the OSD equivalent, refer to "Audio Menu" on page 43.

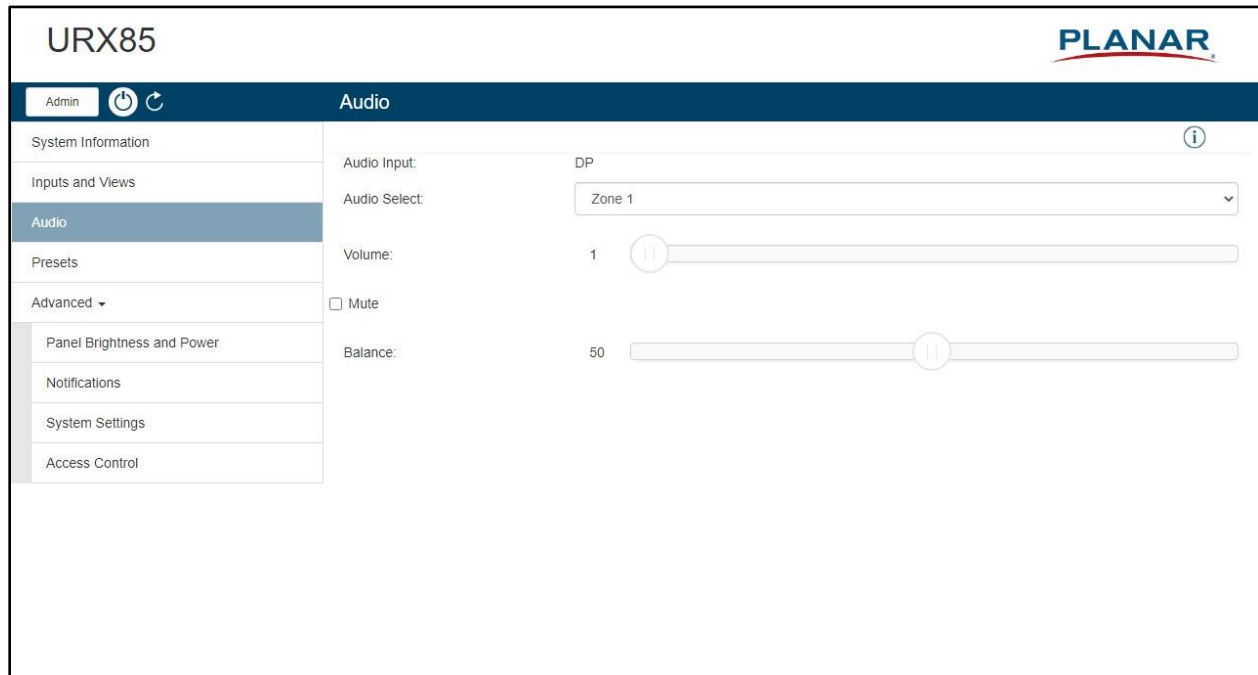

24. Remote Monitoring Presets

This page enables you to save Inputs and Views settings, Image Adjust settings, Audio settings, the Backlight Intensity setting, the Local Dimming setting, and Tiling settings. You can save up to 64 presets using this page (more can be saved via the serial command interface). Only presets that contain saved data are shown in the table, with buttons to recall or delete the corresponding preset.

The controls below the table enable you to save a new preset, or overwrite an existing preset with the current display settings. To save or overwrite a preset, enter the preset number to save or overwrite, optionally enter a custom name for the preset, and then click the **Save** button.

For the OSD equivalent, refer to "Presets Menu" on page 44.

The screenshot shows the Planar URX85 web interface. At the top left is the model name 'URX85' and at the top right is the 'PLANAR' logo. Below the header is a navigation bar with 'Admin', power, and refresh icons. The 'Presets' menu is selected, showing a sidebar with options: System Information, Inputs and Views, Audio, Presets (highlighted), and an 'Advanced' dropdown menu containing Panel Brightness and Power, Notifications, System Settings, and Access Control. The main content area features a table with columns for '#', 'Name', and 'Action'. Two presets are listed: '1 Video Conference' and '2 Satellite Feed', each with 'Recall' and 'Delete' buttons. Below the table is a form for creating a new preset, with a text input for the number '3', a text input for 'New Preset Name', and a 'Save #3' button.

#	Name	Action
1	Video Conference	Recall #1 Delete #1
2	Satellite Feed	Recall #2 Delete #2
3	New Preset Name	Save #3

25. Remote Monitoring Panel Brightness and Power

This page enables you to make adjustments to the brightness and power settings.

For the OSD equivalents, refer to "Panel Brightness Submenu" on page 45 and "Power Submenu" on page 46.

The screenshot displays the URX85 remote monitoring interface. At the top left, the model name "URX85" is shown. At the top right is the "PLANAR" logo. Below the header is a navigation bar with "Admin" and a refresh icon. The main content area is titled "Advanced" and is divided into two columns. The left column is a sidebar menu with options: System Information, Inputs and Views, Audio, Presets, Advanced +, Panel Brightness and Power (highlighted), Notifications, System Settings, and Access Control. The right column contains the settings for "Panel Brightness" and "Power". Under "Panel Brightness", there is a slider for "Intensity" set to 100 and a checked checkbox for "Local Dimming". Under "Power", there is a checked checkbox for "Auto Power On", a dropdown for "Power Saving Mode" set to "Disabled", a dropdown for "Power Saving Delay" set to "1 Minute", a text input for "Power On Delay (s)" set to "0", a dropdown for "Standby Mode" set to "Fast Startup", and a checked checkbox for "OPS Power Down Check".

26. Remote Monitoring Notifications

This page enables you to send email notifications on certain events.

The screenshot shows the URX85 web interface. The top left corner displays 'URX85' and the top right corner features the 'PLANAR' logo. Below the header is a navigation bar with 'Admin' and a refresh icon. The main content area is titled 'Notifications' and is divided into two sections: 'Email Account Settings' and 'Notification Events'.

Email Account Settings

SMTP Server:

Connection Encryption:

Port:

Authentication:

User Name:

Password:

Email From Address:

Notification Events

Event	Recipient(s)	Additional Note	Enabled
Power On/Off	<input type="text"/>	<input type="text"/>	<input type="checkbox"/>
System Error	<input type="text"/>	<input type="text"/>	<input type="checkbox"/>
Source Detect	<input type="text"/>	<input type="text"/>	<input type="checkbox"/>
Source Lost	<input type="text"/>	<input type="text"/>	<input type="checkbox"/>
Source Selected	<input type="text"/>	<input type="text"/>	<input type="checkbox"/>

Test Email

Note: Obtain this information from your ISP or network administrator.

The options under **Email Account Settings** are:

- **SMTP Server:** The name of the outgoing SMTP server. Obtain this information from your ISP.
- **Connection Encryption:** Selects the appropriate encryption method required by the SMTP server.
- **Port:** Selects the port that the SMTP server uses.
- **Authentication:** Use Auto unless directed by your ISP or network administrator.
- **User Name:** Login username for the SMTP server.

- **Password:** Login password for the SMTP server.
- **Email From Address:** The email address that will be shown in the “From:” field of the notification emails.

The options under **Notification Events** are:

- **Power On/Off:** Occurs when standby mode is entered and when the display is powered on.
- **System Error:** Occurs when the display has detected an error within the system.
- **Source Detect:** Occurs when the display detects and displays a new input signal.
- **Source Lost:** Occurs when the current input signal is no longer detected.
- **Source Selected:** Occurs when a different input source is selected for any of the zones.

Note: Each event can be sent to one or more recipients. To add multiple email addresses, separate them by a space.

- **Test Email:** Sends a test of the selected email notification. This is useful for verifying that your email account settings are setup correctly. If the test email fails, you can use the View Last 10 Log Messages button to get more detailed information about the failure.

27. Remote Monitoring System Settings

This page enables you to make adjustments to a variety of system settings.

For the OSD equivalent, refer to "System Settings Submenu" on page 64.

The screenshot displays the 'System Settings' page for a URX85 device. The interface is organized into a sidebar on the left and a main content area on the right. The sidebar includes navigation links for System Information, Inputs and Views, Audio, Presets, Advanced (expanded), Panel Brightness and Power, Notifications, System Settings (selected), and Access Control. The main content area is titled 'System Settings' and contains several sections: 'Display Name' (text input: URX85), 'Touch Control' (dropdown: AUTO), 'Enable Status LED' (checked checkbox), 'Pixel Orbit' (unchecked checkbox), 'Enable HDR' (checked checkbox), 'Enable CEC' (checked checkbox), 'DisplayPort Type' (dropdown: 1.2), 'Keypad Lock' (unchecked checkbox), 'IR Remote Lock' (unchecked checkbox), 'IR Remote ID Code' (text input: 1785), 'Security' (Enable SNMP unchecked, Enable TCP/UDP Commands checked), 'Firmware Update' (Choose File button, No file chosen), 'Save Settings' (Generate Settings Package button), 'Restore Settings' (Choose File button, No file chosen), and 'Save Diagnostics' (Generate Diagnostics Package button). Information icons (i) are present next to the Firmware Update, Save Settings, Restore Settings, and Save Diagnostics sections.

28. Remote Monitoring Access Control

This page enables you to limit the ability to access certain features in the web server by password protecting them.

The screenshot displays the URX85 web interface. At the top left, the model name 'URX85' is shown. At the top right is the 'PLANAR' logo. Below the header is a navigation bar with 'Admin' and a refresh icon. The main content area is titled 'Access Control' and contains two sections: 'Change Passwords' and 'Remove Passwords'. The 'Change Passwords' section has two rows: 'Admin' and 'User'. Each row has a 'New Password' input field, a 'Repeat New Password' input field, and a 'Set [Admin/User] Password' button. The 'Remove Passwords' section has a single 'Remove Passwords' button. Information icons (i) are present in the top right of each section. The left sidebar is visible, showing a menu with 'Access Control' selected.

All functions other than the following require Admin level access:

- Power On/Off
- System Information
- Inputs and Views
 - Multi-Source View
 - Zone inputs
- Presets
 - Recall
- Audio
 - Volume
 - Mute
- Panel Brightness and Power
 - Panel Brightness

With the exception of System Information, all functions listed above require User level access.

If no password is set for either access level, all functions can be accessed. By default, there are no passwords for either access level.

External Control

In addition to using the Planar UltraRes X Series remote control and display, there are other methods of controlling the Planar UltraRes X Series display externally:

- Using a serial link to send ASCII commands and to receive responses to those commands. The same set of commands can be sent over RS-232, USB, TCP or UDP. See the Planar UltraRes X Series RS232 User Manual for more information.
- Using discrete infrared (IR) codes to program a third-party remote control. See "IR Command Protocol" on page 32.
- Using the Planar UltraRes X Series Remote Monitoring software to access the settings in the OSD as well as some additional features via a web browser. See "Planar UltraRes X Series Remote Monitoring Software" on page 72.
- Using HDMI-CEC with compatible devices. See "CEC" on page 65.

HDR

To take full advantage of the benefits of expanded color gamut, bit depth and dynamic range, the Planar UltraRes X Series supports content encoded in HDR (High Dynamic Range). When HDR content is present, the image performance will expand beyond the capabilities of standard dynamic range content, allowing for a wider range of colors, bit depth and dynamic range.

HDR compatible inputs: HDMI 1, HDMI 2 and OPS

Signal Compatibility

Signal Type	Resolution	Frame rate (Hz)	Line Rate (kHz)	Pixel Rate (MHz)	HDMI 1-2, OPS	HDMI 3-4	DisplayPort	References
PC	640x480	59.94	31.469	25.175	x	x	x	VESA DMT, CEA-861-F Format 1
	640x480	72	37.861	31.500	x	x	x	VESA DMT
	640x480	74.99	37.500	31.500	x	x	x	VESA DMT
	640x480	85	43.269	36.000	x	x	x	VESA DMT
	800x600	60.32	37.890	40.000	x	x	x	VESA DMT
	800x600	72	48.077	50.000	x	x	x	VESA DMT
	800x600	75	46.875	49.500	x	x	x	VESA DMT
	800x600	85.06	53.674	56.250	x	x	x	VESA DMT
	848x480	59.659	29.830	31.500	x	x	x	VESA CVT
	848x480	74.769	37.684	41.000	x	x	x	VESA CVT
	848x480	84.751	42.969	46.750	x	x	x	VESA CVT
	1024x768	60	48.363	65.000	x	x	x	VESA DMT
	1024x768	70	56.476	75.000	x	x	x	VESA DMT
	1024x768	75.03	60.023	78.750	x	x	x	VESA DMT
	1024x768	85.03	68.677	94.500	x	x	x	VESA DMT
	1152x864	70.012	63.851	94.500	x	x	x	VESA DMT
	1152x864	75	67.500	108.000	x	x	x	VESA DMT
	1152x864	84.999	77.094	121.500	x	x	x	VESA DMT
	1280x768	49.929	39.593	65.250	x	x	x	VESA CVT
	1280x768	59.995	47.396	68.250	x	x	x	VESA CVT-R
	1280x768	60	47.776	79.500	x	x	x	VESA CVT
1280x768	74.893	60.289	102.250	x	x	x	VESA CVT	

Signal Type	Resolution	Frame rate (Hz)	Line Rate (kHz)	Pixel Rate (MHz)	HDMI 1-2, OPS	HDMI 3-4	DisplayPort	References
PC	1280x768	84.837	68.633	117.500	x	x	x	VESA CVT
	1280x960	60	60.000	108.000	x	x	x	VESA DMT
	1280x960	75	75.000	126.000	x	x	x	VESA DMT
	1280x960	85.002	85.938	148.500	x	x	x	VESA DMT
	1280x1024	60.02	63.981	108.000	x	x	x	VESA DMT
	1280x1024	75.02	79.976	135.000	x	x	x	VESA DMT
	1280x1024	85.02	91.146	157.500	x	x	x	VESA DMT
	1360x768	60	47.712	85.500	x	x	x	VESA DMT
	1400x1050	49.965	54.113	100.000	x	x	x	VESA CVT
	1400x1050	60	64.7	101.00	x	x	x	VESA CVT-R
	1400x1050	60	65.317	121.750	x	x	x	VESA CVT
	1400x1050	74.867	82.278	156.000	x	x	x	VESA CVT
	1600x1200	60	75.000	162.000	x	x	x	VESA DMT
	1920x1080	49.929	55.621	141.500	x	x	x	VESA CVT
	1920x1080	59.963	67.158	173.000	x	x	x	VESA CVT
	1920x1080	59.950	66.587	138.500	x	x	x	VESA CVT-R
	1920x1200	49.932	61.816	158.250	x	x	x	VESA CVT
	1920x1200	59.950	74.038	154.000	x	x	x	VESA CVT-R
	1680x1050	49.974	54.121	119.500	x	x	x	VESA CVT
	1680x1050	59.954	65.290	146.250	x	x	x	VESA CVT
	1920x2160	60	135.000	297.000	x	x	x	CEA-861-F, VIC 16, with vertical parameters doubled
	2560x1440	59.951	88.787	241.500	x	x	x	VESA CVT-R
	2560x1600	59.972	98.713	268.500	x	x	x	VESA CVT-R
3840x2160	24	52.438	209.750	x	x	x	VESA CVT-R	

Signal Type	Resolution	Frame rate (Hz)	Line Rate (kHz)	Pixel Rate (MHz)	HDMI 1-2, OPS	HDMI 3-4	DisplayPort	References
PC	3840x2160	30	65.688	262.750	x	x	x	VESA CVT-R
	3840x2160	50	110.500	442.000	x		x	VESA CVT-R
	3840x2160	60	133.313	533.250	x		x	VESA CVT-R
Apple Mac	640x480	66.59			x	x	x	
	832x624	75.087	49.107	55.000	x	x	x	
	1024x768	59.278	48.193	64.000	x	x	x	
	1024x768	74.927	60.241	80.000	x	x	x	
	1152x870	75.062	68.681	100.000	x	x	x	
SDTV	480i	60			x	x	x	SMPTE 125M, CEA-861-F Formats 6 & 7
	576i	50			x	x	x	ITU-R BT.601, CEA-861-F Formats 21 & 22
EDTV	480p	60	31.469	27.000	x	x	x	ITU-R BT.1358, CEA-861-F Format 17 & 18
	576p	50	31.250	27.000	x	x	x	SMPTE 125M, CEA-861-F Format 6 & 7
HDTV	1080i	50	28.125	74.500	x	x	x	SMPTE 274M, CEA-861-F Format 20
	1080i	60	33.750	74.250	x	x	x	SMPTE 274M, CEA-861-F Format 5
	720p	50	37.500	74.250	x	x	x	SMPTE 296M, CEA-861-F Format 19
	720p	60	45.000	74.250	x	x	x	SMPTE 296M, CEA-861-F Format 4
	1080p	24	27.000	74.250	x	x	x	SMPTE 274M, CEA-861-F Format 32
	1080p	25	28.125	74.250	x	x	x	SMPTE 274M, CEA-861-F Format 33
	1080p	30	33.750	74.250	x	x	x	SMPTE 274M, CEA-861-F Format 34
	1080p	50	56.250	148.500	x	x	x	SMPTE 274M, CEA-861-F Format 31
	1080p	60	67.500	148.500	x	x	x	SMPTE 274M, CEA-861-F Format 16

Signal Type	Resolution	Frame rate (Hz)	Line Rate (kHz)	Pixel Rate (MHz)	HDMI 1-2, OPS	HDMI 3-4	DisplayPort	References
UHDTV	3840x2160	24	54.000	297.000	x	x	x	CEA-861-F Format 93, HDMI 1.4b VIC 1
	3840x2160	25	56.250	297.000	x	x	x	CEA-861-F Format 94, HDMI 1.4b VIC 2
	3840x2160	30	67.500	297.000	x	x	x	CEA-861-F Format 95, HDMI 1.4b VIC 3
	3840x2160	50	67.500	297.000	x			CEA-861-F Format 96, 4:2:0 sub-sampling
	3840x2160	50	135.000	594.000	x		x	CEA-861-F Format 96
	3840x2160	60	67.500	297.000	x			CEA-861-F Format 97, 4:2:0 sub-sampling
	3840x2160	60	135.000	594.000	x		x	CEA-861-F Format 97

Color Subsampling Report

Video Timing	Input	RGB 4:4:4 Supported	YUV 4:4:4 Supported	YUV 4:2:2 Supported	YUV 4:2:0 Supported
4K @ 50/60 Hz	DP	x	x	x	
4K @ 50/60 Hz	HDMI 1-2, OPS	x	x	x	x
4K @ 50/60 Hz	HDMI 3-4				
All Other Supported Timings	Any	x	x	x	

Power Consumption

The power consumption values stated in the Specifications table are calculated under the typical conditions of viewing a single source with default settings.

Due to the advanced capabilities of the Planar UltraRes X Series, and the widely variable power consumption of user-installed OPS devices, the total maximum power draw of Planar UltraRes X Series is influenced by several factors:

- The use of advanced features such as Multi Source view, tiling and image scaling variables that occur for each source and image configuration
- The use of MEMC (frame interpolation)
- The use of Local Dimming and backlight variables that occur as content changes
- The variable power consumption of an installed OPS device

Given the relatively low likelihood of all the above conditions being met and maximized simultaneously, the “Power Consumption: Backlight Max (Typ.)” value is instead calculated by increasing the default backlight value of 75 to 100, and multiplying the wattage by approximately 1.33. The power consumption would increase above these specified values if the above factors are introduced, and should be taken into account when estimating power consumption.

Specifications

Item	URX75 URX75-ERO URX75-ERO-T	URX85 URX85-ERO URX85-ERO-T	URX100 URX100-ERO URX100-ERO-T
LCD Panel			
Display Technology	Commercial-Grade VA LCD		
Resolution	3840x2160		
Aspect Ratio	16:9		
Screen Size	75"	85"	100"
Orientation	Landscape/Portrait		
Brightness (Typ.)	Non-ERO versions: 700 cd/m ² ERO and ERO-T versions: 630 cd/m ²		
Contrast Ratio (Typ.; local dimming enabled)	20,000:1		N/A
Contrast Ratio (Typ.; local dimming disabled)	5000:1	4000:1	3000:1
Viewing Angle (Typ.)	178 degrees		
Response Time (Typ.)	6.5ms	8.5ms	6.5ms
Color Gamut	88% NTSC		98% NTSC
Display Color	1.07 billion (10-bit depth)		
Connectivity			
Standard Inputs	DisplayPort 1.2, HDMI 2.0 x 2, HDMI 1.4 x 2, OPS		
HDCP 2.2	Yes (HDMI 2.0)		
Audio Output	Line out, S/PDIF out		
Control and Monitoring	LAN RJ45, RS232 In, IR, Keypad, Planar® UltraRes X™ Series App		

Item	URX75 URX75-ERO URX75-ERO-T	URX85 URX85-ERO URX85-ERO-T	URX100 URX100-ERO URX100-ERO-T
Mechanical			
Display Dimensions	URX75: 66.3" x 37.9" x 3.7" (1684.7mm x 962.7mm x 94.2mm) URX75-ERO: 66.3" x 37.9" x 3.7" (1684.7mm x 962.7mm x 94.2mm) URX75-ERO-T: 67.1" x 38.7" x 4.0" (1704.6mm x 982.6mm x 102.6mm)	URX85: 75.6" x 43.3" x 3.7" (1919.0mm x 1100.0mm x 94.3mm) URX85-ERO: 75.6" x 43.3" x 3.7" (1919.0mm x 1100.0mm x 94.3mm) URX85-ERO-T: 76.3" x 44.1" x 4.1" (1938.9mm x 1119.9mm x 102.8mm)	URX100: 89.0" x 50.9" x 3.7" (2260.8mm x 1294.1mm x 94.3mm) URX100-ERO: 89.0" x 50.9" x 3.7" (2260.8mm x 1294.1mm x 94.3mm) URX100-ERO-T: 89.7" x 51.7" x 4.0" (2279.4mm x 1312.7mm x 101.7mm)
Display Edge to Active Area	URX75: 0.7" (17.2mm) URX75-ERO: 0.7" (17.2mm) URX75-ERO-T: 1.1" (27.2mm)	URX85: 0.9" (23.5mm) URX85-ERO: 0.9" (23.5mm) URX85-ERO-T: 1.3" (33.5mm)	URX100: 1.1" (28.8mm) left/right; 1.1" (27.4mm) top/bottom URX100-ERO: 1.1" (28.8mm) left/right; 1.1" (27.4mm) top/bottom URX100-ERO-T: 1.5" (38.8mm) left/right; 1.5" (37.4mm) top/bottom
Bezel Width	URX75: 0.6" (16.5mm) URX75-ERO: 0.1" (3mm) URX75-ERO-T: 0.4" (10.3mm)	URX85: 0.9" (23mm) URX85-ERO: 0.1" (3mm) URX85-ERO-T: 0.4" (10.3mm)	URX100: 1.1" (27.1mm) URX100-ERO: 0.1" (3mm) URX100-ERO-T: 0.4" (10.3mm)
Display Weight	URX75: 145 lbs (66 kg) URX75-ERO: 165 lbs (75 kg) URX75-ERO-T: 185 lbs (84 kg)	URX85: 190 lbs (86 kg) URX85-ERO: 220 lbs (100 kg) URX85-ERO-T: 235 lbs (107 kg)	URX100: 300 lbs (136 kg) URX100-ERO: 355 lbs (161 kg) URX100-ERO-T: 370 lbs (168 kg)
Mounting	Planar Profile Mounting System or VESA 400 mm x 400 mm	Planar Profile Mounting System or VESA 600 mm x 400 mm	
Wall Mount Weight	15lb (6.8kg)		
Fanless	Yes		
Speakers	10W x 2 built-in		
ERO (ERO and ERO-T models only)			
Surface Treatment	Anti-glare (AG)		Anti-reflective (AR)
Protective Glass	2mm Corning® Gorilla® Glass		3mm soda-lime

Item	URX75 URX75-ERO URX75-ERO-T	URX85 URX85-ERO URX85-ERO-T	URX100 URX100-ERO URX100-ERO-T
Touch (ERO-T models only)			
Touch Technology	IR 32-point, 2mm minimum tip width		
Touch Interface	USB-B		
Supporting OS	Windows 7, 8, 10; Mac OSX, Linux		
Usage			
Recommended Usage	Up to 24x7		
Backlight	D-LED		
Backlight Life	50,000 hours min	70,000 hours min	50,000 hours min
Power Source			
Power Consumption (Typ.)	180W	270W	380W
Power Consumption: Backlight Max (Typ.)	240W	360W	505W
BTU/hr (Typ.)	180W x 3.42 BTU = 616 BTU/hr	270W x 3.42 BTU = 923 BTU/hr	380W x 3.42 BTU = 1300 BTU/hr
Standby Power Consumption	< 0.5W		
Input Voltage / Frequency	AC 100-240V 50-60 Hz		
AC Inlet Type	C14		
Environment			
Storage Temperature	Min -4°F ~ Max 140°F (-20°C ~ 60°C)		
Operating Temperature	Min 32°F ~ Max 104°F (0-40°C) at up to 3000 m	Min 32°F ~ Max 104°F (0-40°C) at up to 1500 m Min 32°F ~ Max 95°F (0-35°C) at up to 3000 m	Min 32°F ~ Max 104°F (0-40°C) at up to 3000 m
Humidity	20-85% RH		
Approvals	FCC Class A, cTUVus, CE		

Dimensions

29. URX75

29.1 URX75 Standard

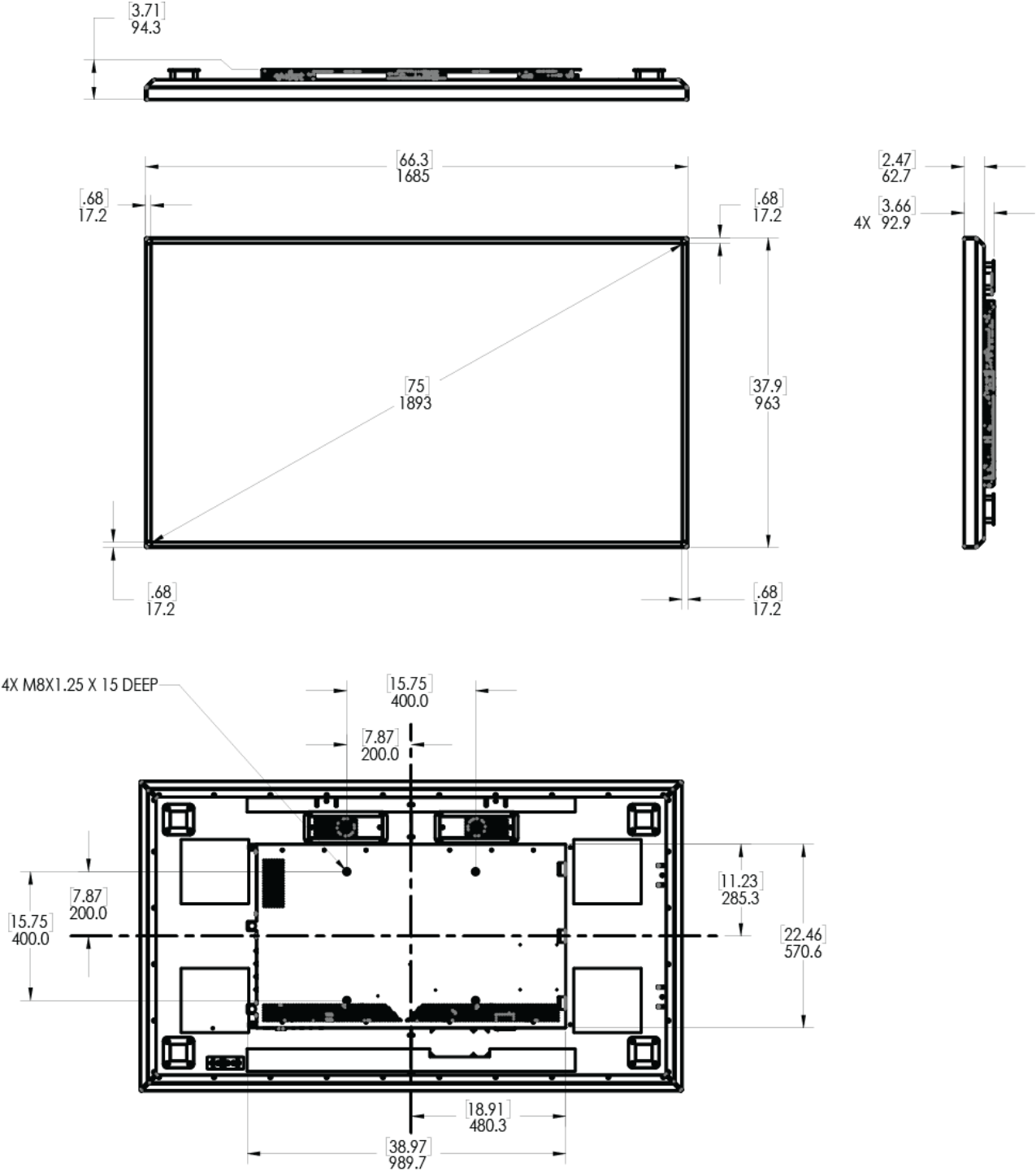

29.2 URX75-ERO

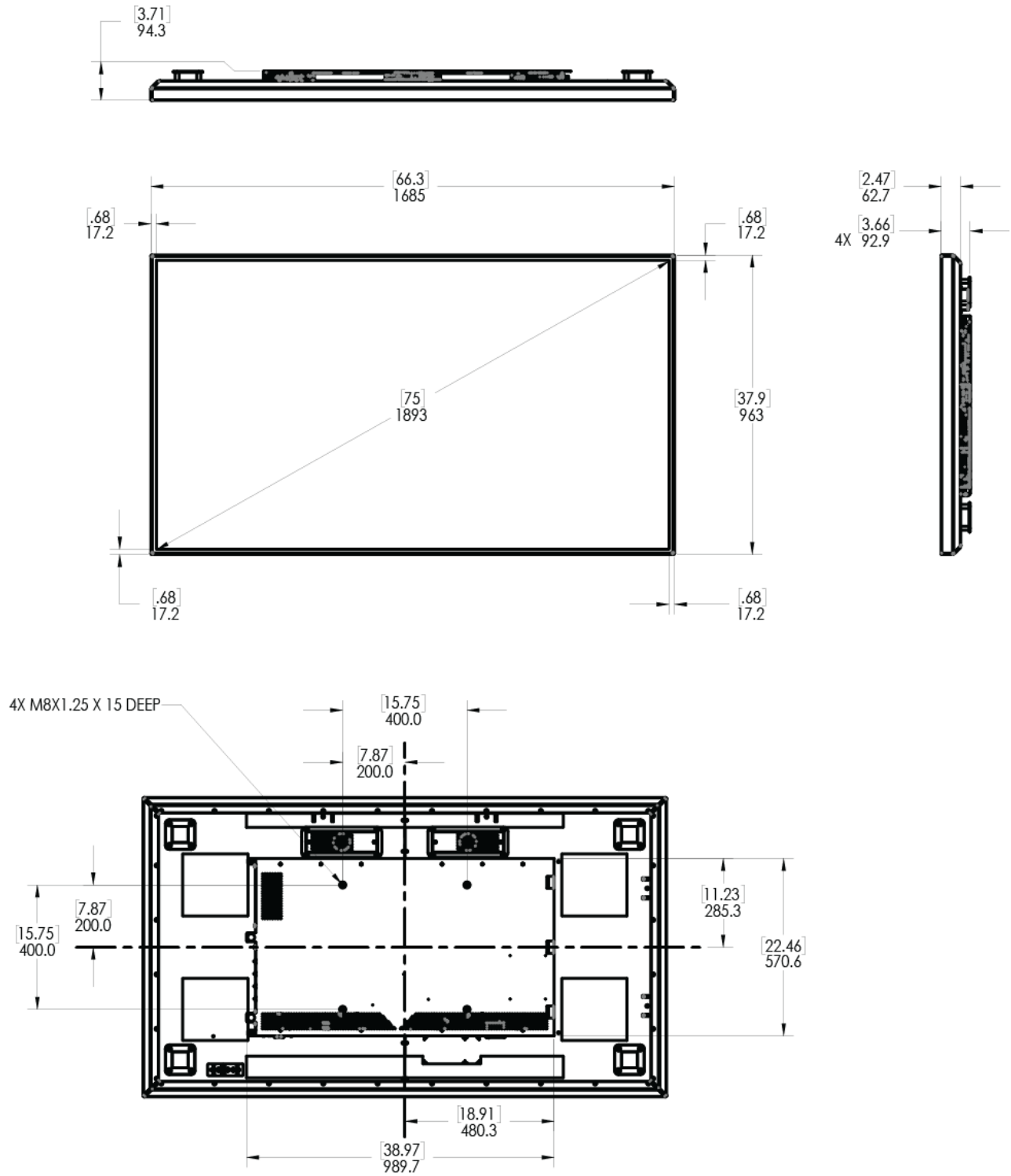

29.3 URX75-ERO-T

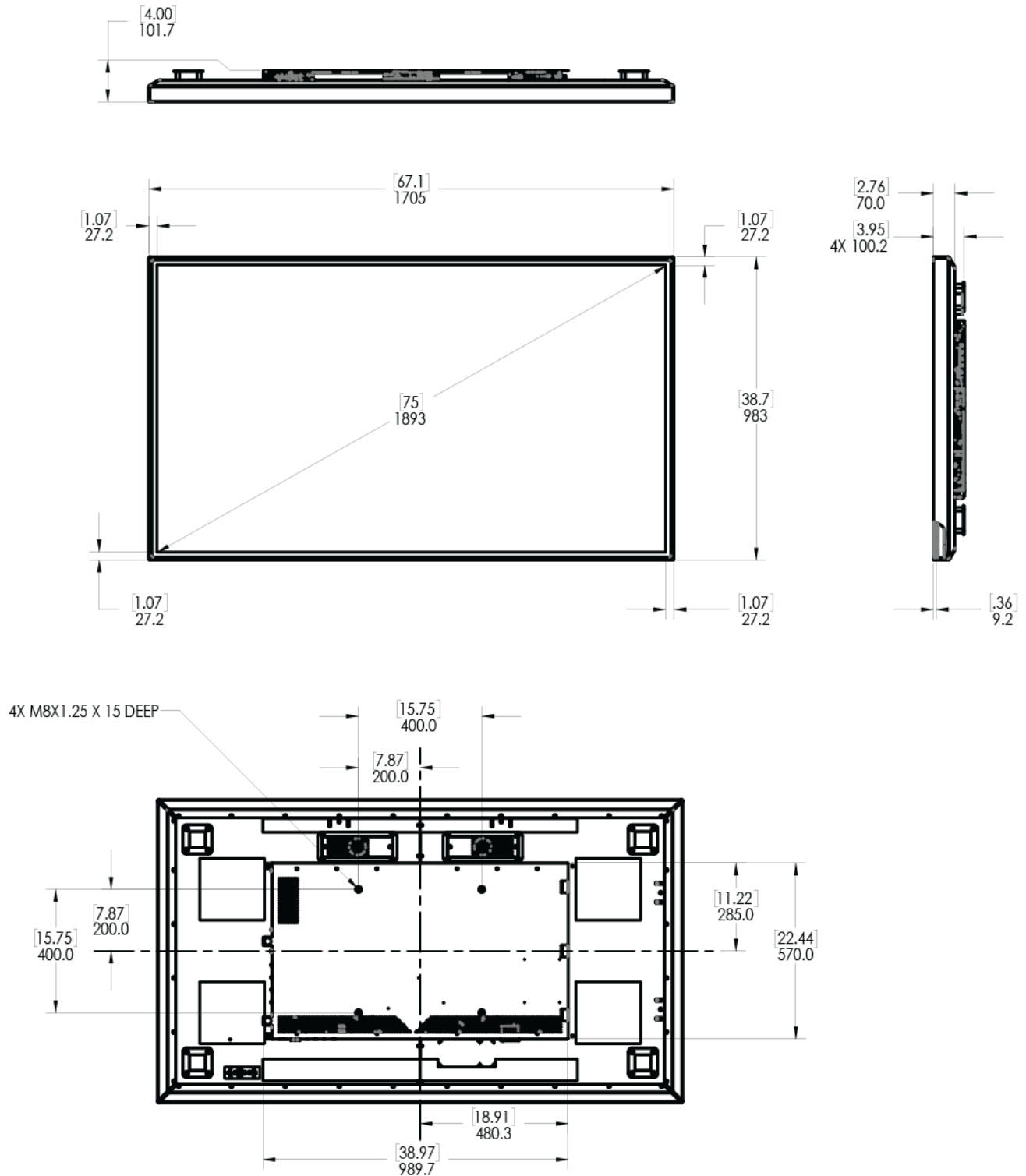

30. URX85

30.1 URX85 Standard

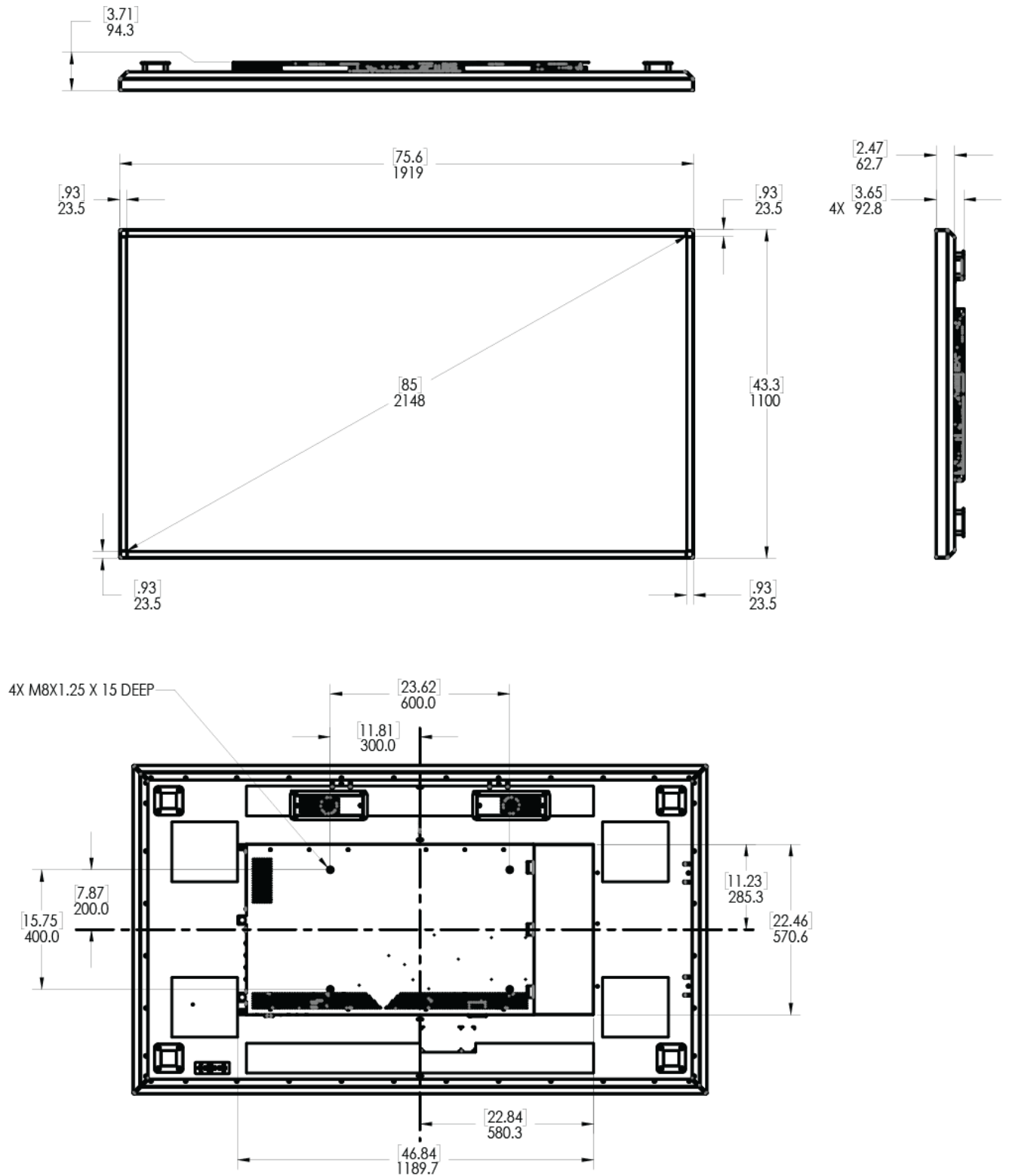

30.2 URX85-ERO

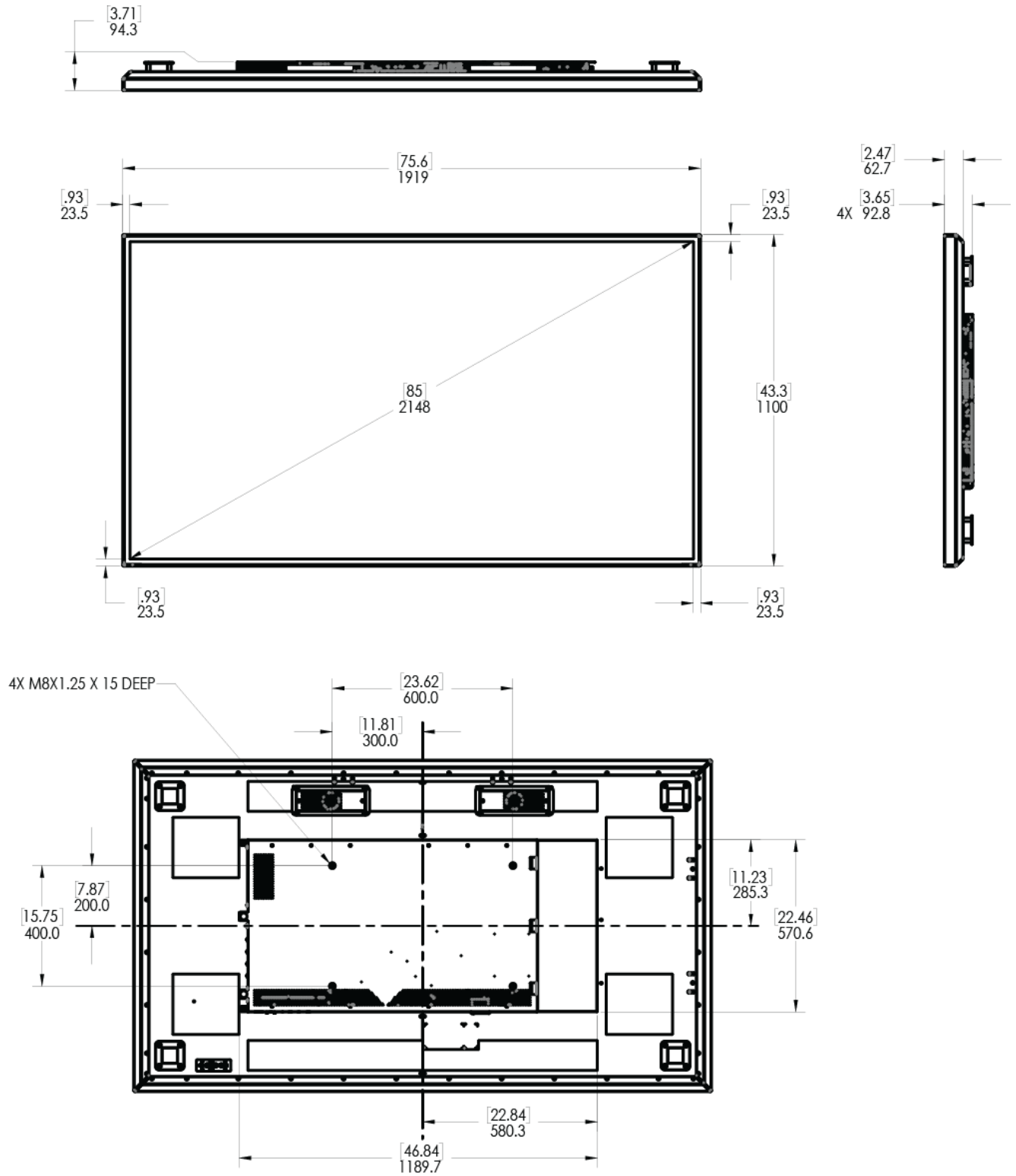

30.3 URX85-ERO-T

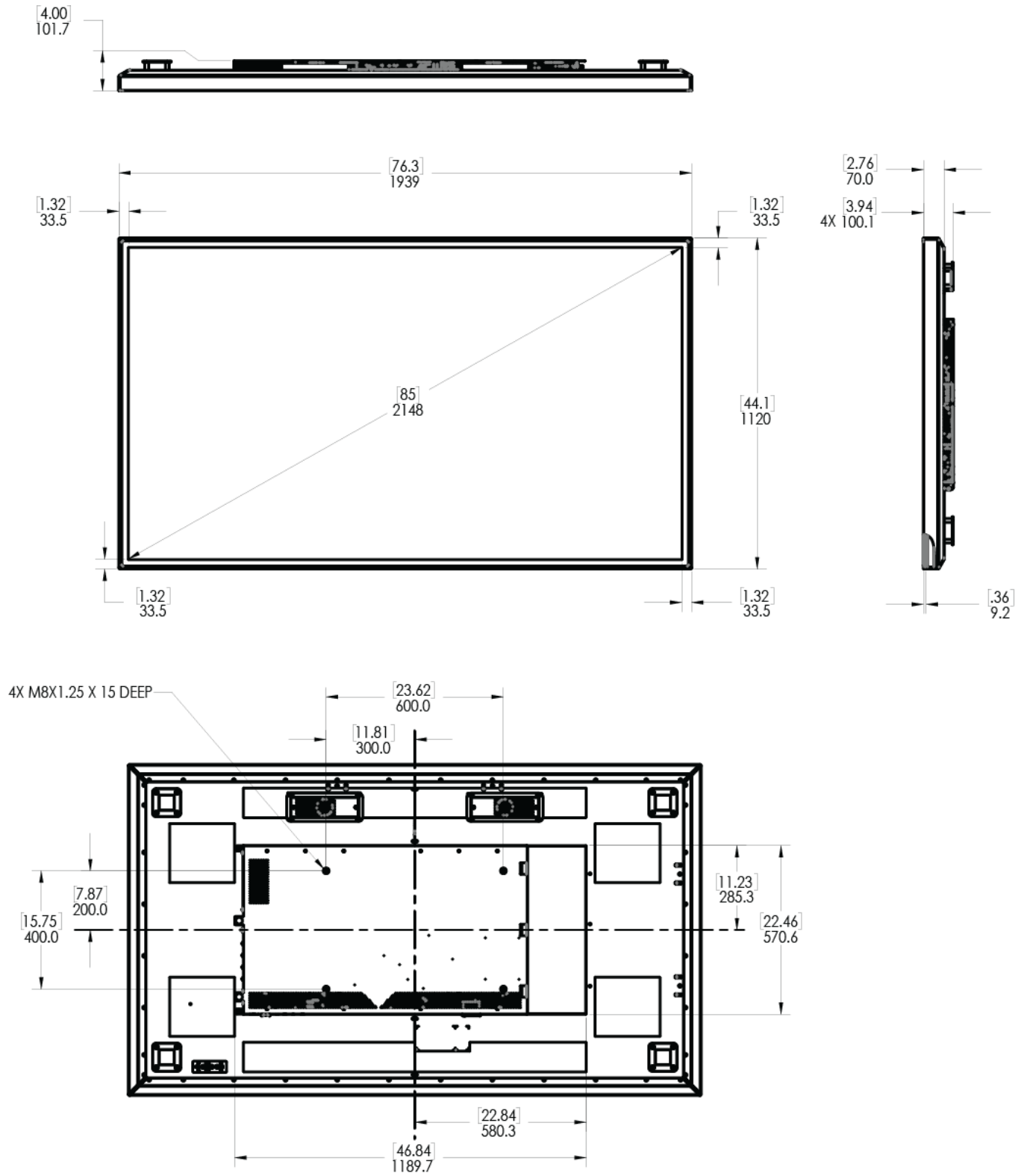

31. URX100

31.1 URX100 Standard

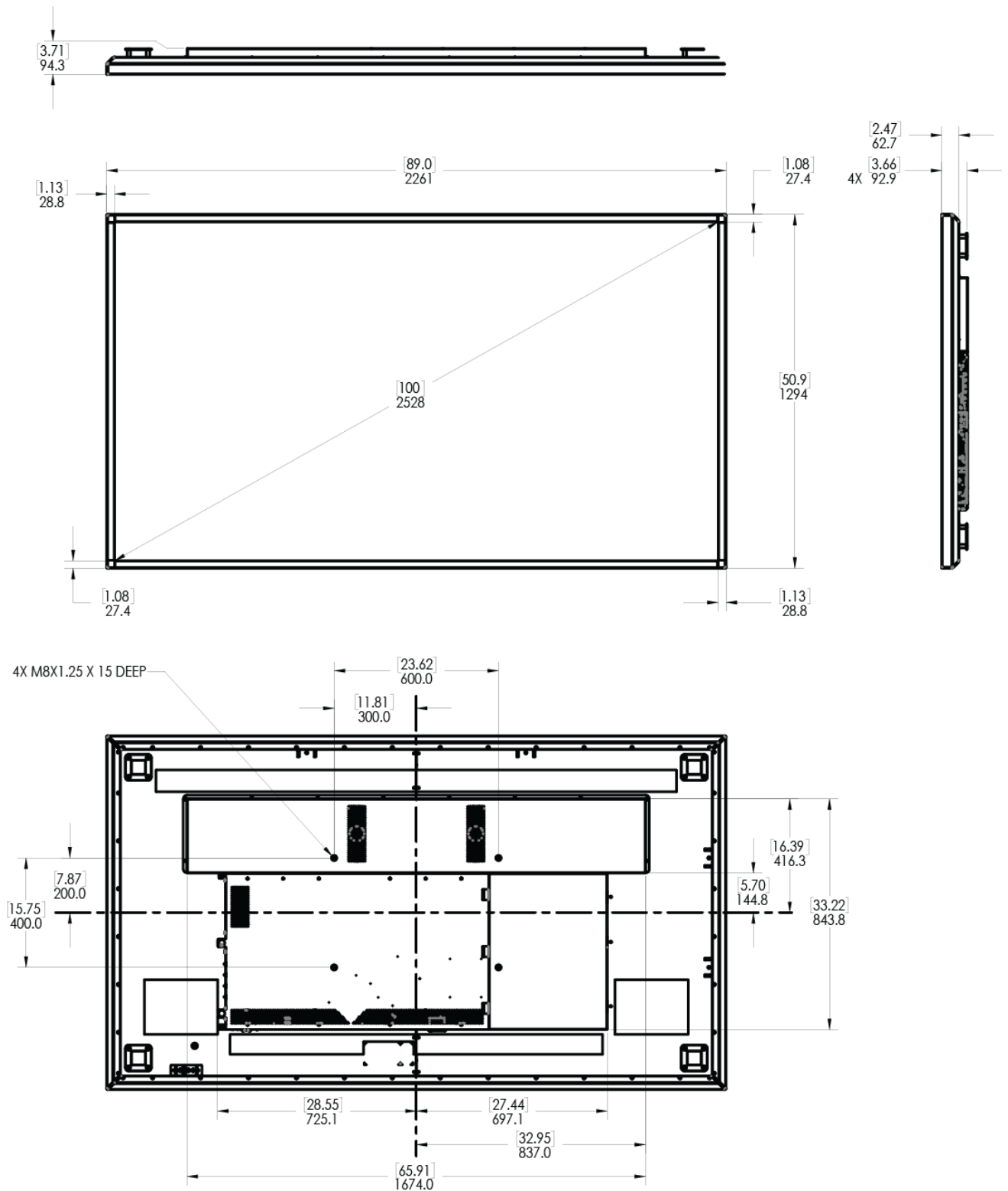

31.2 URX100-ERO

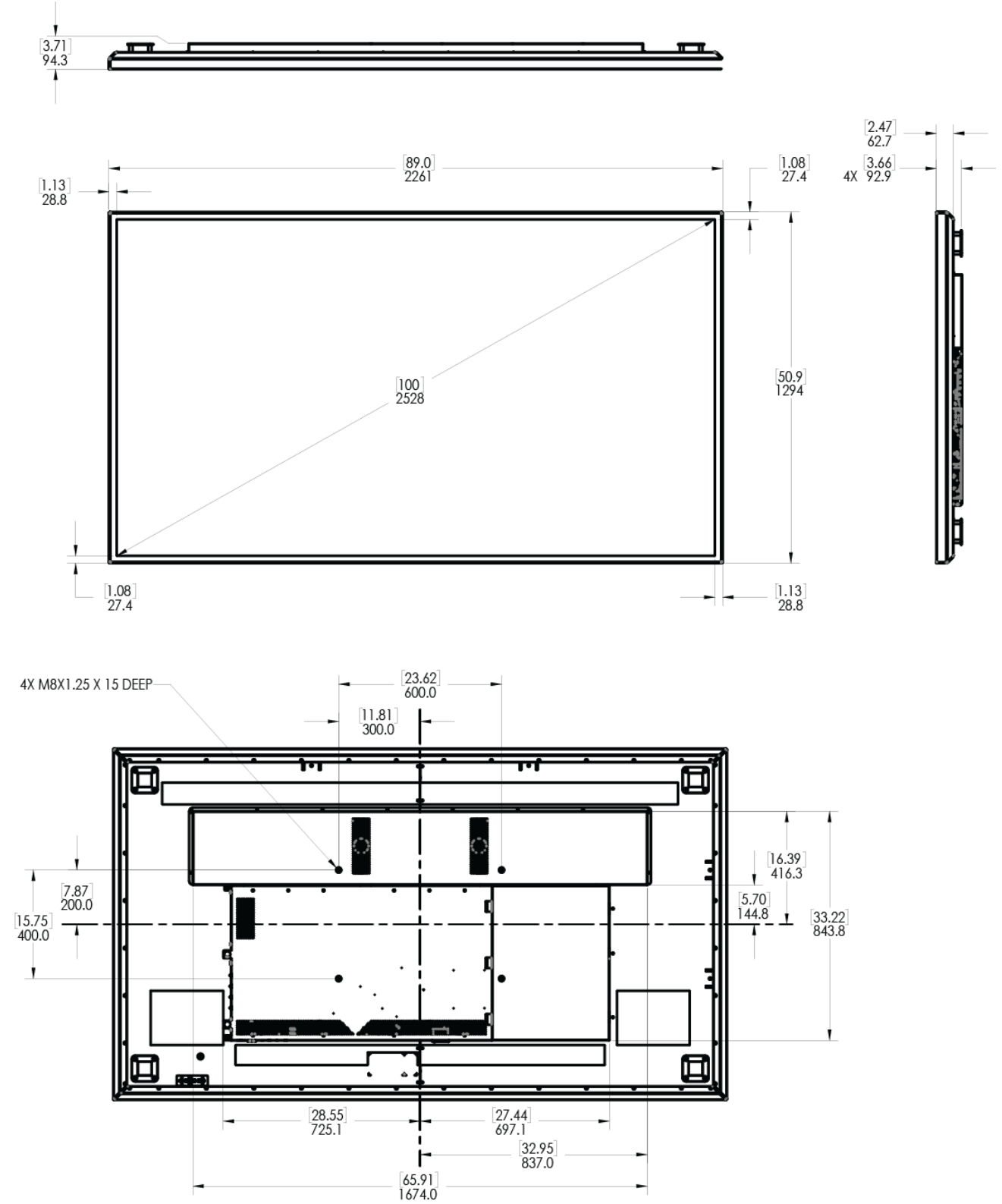

31.3 URX100-ERO-T

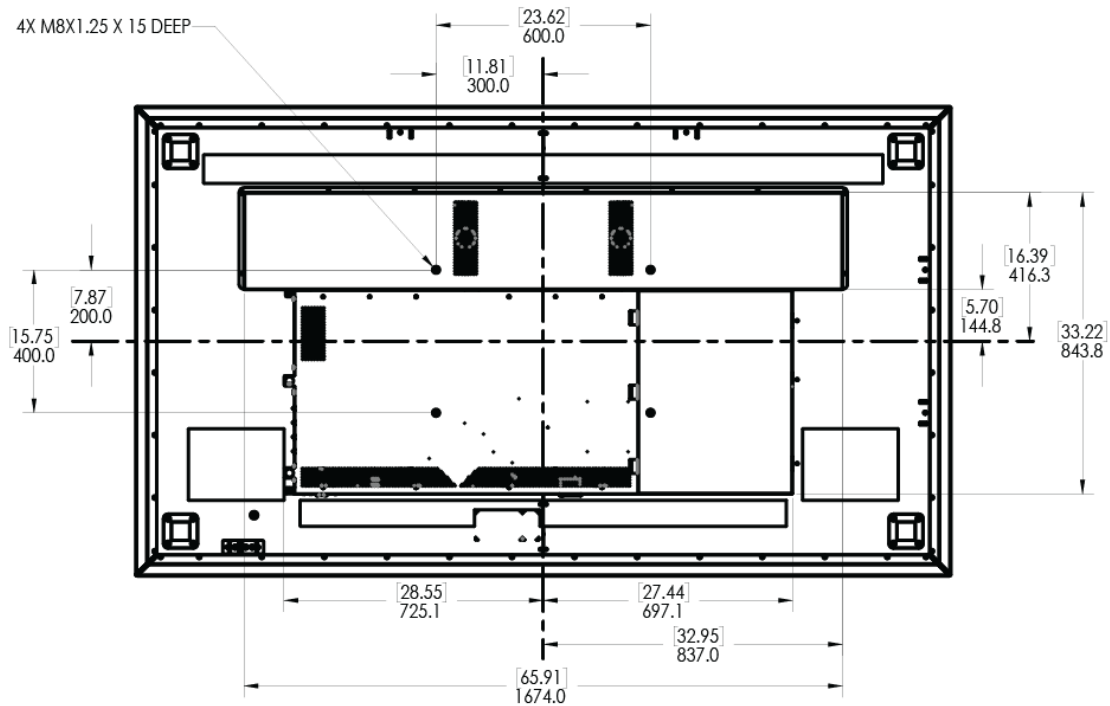
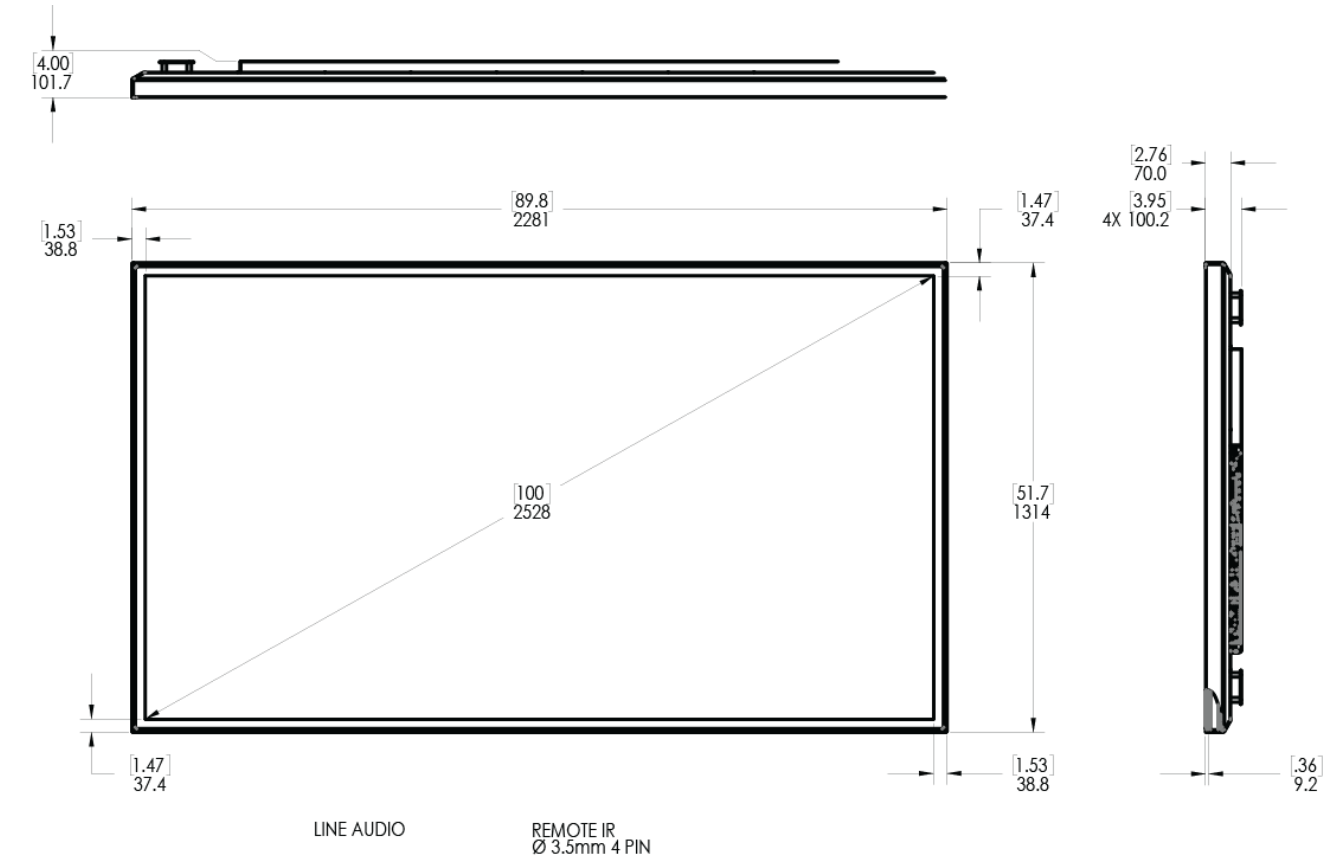

Troubleshooting During Installation

This section includes troubleshooting information about different issues you may encounter during the installation process or after your display has been running for some time. If you are not able to solve your issue in this section, please contact Planar's Technical Support team for assistance.

32. Error Codes

To see the last 50 errors that have occurred, select the Error Log tab in the OSD (MAIN MENU > INFORMATION > ERROR LOG), as shown below.

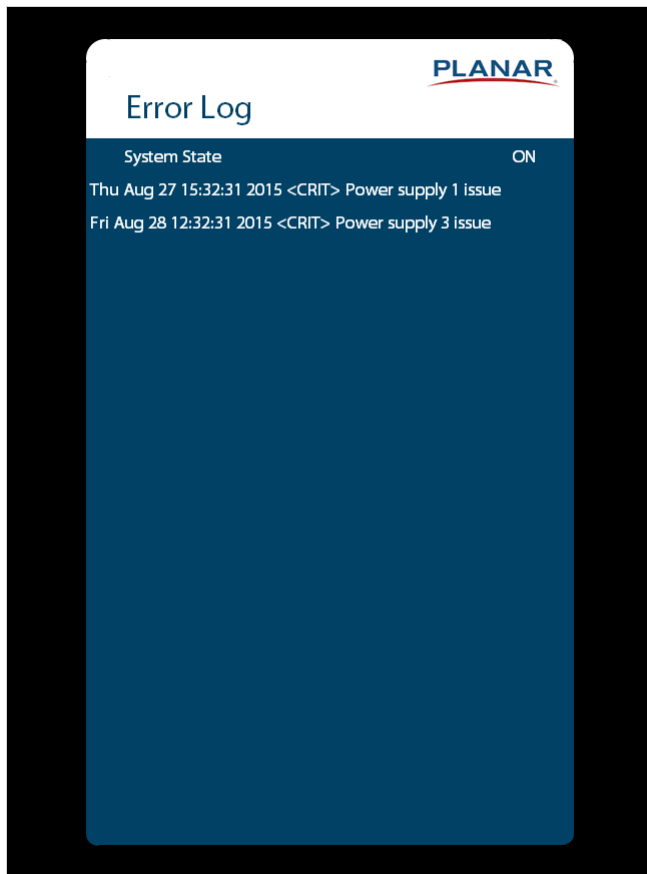

Possible error codes include:

- Power supply 1 issue
- Power supply 2 issue
- Power supply 3 issues do not apply to the 75" models
- Calibration EEPROM board disconnected

Note the following:

- One power supply failure will limit the backlight intensity to 50% maximum and two power supply failures will shut off the display.

33. Symptoms, Possible Causes and Solutions

Below are different symptoms that you might encounter as you install your Planar UltraRes X Series display. First look at the different symptoms to see if you can find your issue. And then look at the possible cause and try the suggested solution(s). If you still are not able to resolve your issue, please contact Planar's Technical Support Department.

33.1 Symptom: Display Doesn't Respond to External Control System

Solution

Confirm the **Power Down Mode** setting. **Networked standby** or **Fast Startup** are required to enable the use of external control devices. **Standby** disables all external control except IR, allowing the display to be in the lowest power setting. See "Power Down Mode" on page 47.

33.2 Symptom: Can't Get PC to Output 4K @ 24/30/60 Hz

Solution

Confirm that DisplayPort-to-HDMI adapters are not being used. These adapters do not support outputting 4K content.

Solution

Make sure you are using a high-speed HDMI or a Certified Premium HDMI cable. Standard HDMI cables might work but are not guaranteed.

Solution

Verify that the selected **EDID Type** setting in the OSD is **4K60** or **4K30**. If you change the EDID setting, you may need to disconnect and reconnect the cable.

Solution

If you are trying to use 4K @ 60 Hz on HDMI, the display must be connected to HDMI 1 or HDMI 2.

Solution

If you are trying to display 4K @ 60 Hz on HDMI 1 or HDMI 2, the Multi-Source View setting must be Single.

33.3 Symptom: Can't Get PC to Output 4K @ 24/30/60 Hz

Possible Cause

The connector overmold is too large, which can cause the pins not to contact properly on some cards.

Solution

If using DisplayPort, make sure the connector overmold isn't too large.



33.4 Symptom: Can't Select OPS or HDMI 1

Solution

The OPS and HDMI sources cannot be viewed at the same time. If your Multi-Source View setting is not Single, and you select OPS in a zone, any zones that are showing HDMI 1 will automatically change to OPS. Conversely, if you select HDMI 1 in a zone, any zones that are currently showing OPS will automatically change to HDMI 1.

33.5 Symptom: IR Isn't Working Properly

Possible Cause

The wired IR module may not be fully connected.

Solution

Make sure the IR is fully connected by pressing hard to ensure it is inserted as far as possible.

Possible Cause

The wired IR module cable is not being used.

Solution

Make sure that the wired IR module cable is being used.



33.6 Symptom: Touch Has Broken Response Near Middle/Bottom of Display

Possible Cause

The display is mounted tilted forward.

Solution

Reposition the display so it is vertical to slightly tilted back.

Possible Cause

There are items blocking the IR sensors from emitting or receiving

Solution

Clean display and sensor windows around the display.

Accessing Planar's Technical Support Website

Go to <http://www.planar.com/support/> to access the following support documents and resources:

- User Manual
- RS232 User Manual
- Outline drawings
- Standard warranties
- Planar support hotline number and email
- Firmware (contact Planar support via email or phone)