

PHILIPS

Professional
Display Solutions

D Line

32BDL4550D



www.philips.com/welcome

User Manual (English)

Safety Instructions

Safety precautions and maintenance



WARNING: Use of controls, adjustments or procedures other than those specified in this documentation may result in exposure to shock, electrical hazards and/or mechanical hazards.

Read and follow these instructions when connecting and using your display:

Operation:

- Keep the display out of direct sunlight and away from stoves or any other heat sources.
- Keep the display away from oil, otherwise the plastic cover may be damaged.
- It is recommended to set the display up in the well-ventilated place.
- Ultra-violet ray filter is necessary of outdoor operation.
- If the product will be used in extreme conditions such as high temperature, humidity, display patterns or operation time etc... It is strongly recommended to contact Philips for Application engineering advice. Otherwise, its reliability and function may not be guaranteed. Extreme conditions are commonly found at Airports, Transit Stations, Banks, Stock market, and Controlling systems.
- Remove any object that could fall into ventilation holes or prevent proper cooling of the display's electronics.
- Do not block the ventilation holes on the cabinet.
- When positioning the display, make sure the power plug and outlet are easily accessible.
- When turning off the display by detaching the power cord, wait 6 seconds before re-attaching the power cord for normal operation.
- Ensure the use of an approved power cord provided by Philips at all times. If your power cord is missing, please contact your local service center.
- Do not subject the display to severe vibration or high impact conditions during operation.
- Do not knock or drop the display during operation or transportation.
- The eye bolt is for usage in short-time maintenance and installation. We suggest not to use the eye bolt for more than 1 hour. Prolong usage is prohibited. Please keep a clear safety area under the display while using the eye bolt.

Maintenance:

- To protect your display from possible damage, do not put excessive pressure on the LCD panel. When moving your display, grasp the frame to lift; do not lift the display by placing your hand or fingers on the LCD panel.
- Unplug the display if you are not going to use it for an extensive period of time.
- Unplug the display if you need to clean it with a slightly damp cloth. The screen may be wiped with a dry cloth when the power is off. However, never use organic solvent, such as, alcohol, or ammonia-based liquids to clean your display.
- To avoid the risk of shock or permanent damage to the set, do not expose the display to dust, rain, water or an excessively moist environment.
- If your display becomes wet, wipe it with dry cloth as soon as possible.
- If a foreign substance or water gets in your display, turn the power off immediately and disconnect the power cord. Then remove the foreign substance or water, and send the unit to the maintenance center.
- Do not store or use the display in locations exposed to heat, direct sunlight or extreme cold.
- In order to maintain the best performance of your display and ensure a longer lifetime, we strongly recommend using the display in a location that falls within the following temperature and humidity ranges.

Environmental absolute ratings

| Item | Min. | Max. | Unit |
|---------------------------------------|------|------|------|
| Storage temperature | -20 | 65 | °C |
| Operation temperature | 0 | 40 | °C |
| Glass Surface temperature (Operation) | 0 | 65 | °C |
| Storage humidity | 5 | 90 | % RH |
| Operating humidity | 20 | 80 | % RH |

- LCD panel temperature need to be 25 degrees Celsius at all time for better luminance performance.

- Only the lifetime of the display stated in this specification is guaranteed if the display is used under the proper operation conditions.

IMPORTANT: Always activate a moving screen saver program when you leave your display unattended. Always activate a periodic screen refresh application if the unit will display unchanging static content. Uninterrupted display of still or static images over an extended period may cause “burn in”, also known as “after-imaging” or “ghost imaging”, on your screen. This is a well-known phenomenon in LCD panel technology. In most cases, the “burned in” or “after-imaging” or “ghost imaging” will disappear gradually over a period of time after the power has been switched off.

WARNING: Severe “burn-in” or “after-image” or “ghost image” symptoms will not disappear and cannot be repaired. This is also not covered under the terms of your warranty.

Service:

- The casing cover should be opened only by qualified service personnel.
- If there is any need for repair or integration, please contact your local service center.
- Do not leave your display under direct sunlight.



If your display does not operate normally, having followed the instructions set out in this document, please contact a technician or your local service center.

Stability Hazard.

The device may fall, causing serious personal injury or death. To prevent injury, this device must be securely attached to the floor/wall in accordance with the installation instructions.

Read and follow these instructions when connecting and using your display:



- Unplug the display if you are not going to use it for an extensive period of time.
- Unplug the display if you need to clean it with a slightly damp cloth. The screen may be wiped with a dry cloth when the power is off. However, never use alcohol, solvents or ammonia-based liquids.
- Consult a service technician if the display does not operate normally when you have followed the instructions in this manual.
- The casing cover should be opened only by qualified service personnel.
- Keep the display out of direct sunlight and away from stoves or any other heat sources.
- Remove any object that could fall into the vents or prevent proper cooling of the display’s electronics.
- Do not block the ventilation holes on the cabinet.
- Keep the display dry. To avoid electric shock, do not expose it to rain or excessive moisture.
- When turning off the display by detaching the power cable or DC power cord, wait for 6 seconds before re-attaching the power cable or DC power cord for normal operation..
- To avoid the risk of shock or permanent damage to the set do not expose the display to rain or excessive moisture.
- When positioning the display, make sure the power plug and outlet are easily accessible.
- **IMPORTANT:** Always activate a screen saver program during your application. If a still image in high contrast remains on the screen for an extended period of time, it may leave an ‘after-image’ or ‘ghost image’ on the front of the screen. This is a well-known phenomenon that is caused by the shortcomings inherent in LCD technology. In most cases the afterimage will disappear gradually over a period of time after the power has been switched off. Be aware that the after-image symptom cannot be repaired and is not covered under warranty.
- If provided with a 3-pin attachment plug on the power cord, plug the cord into a grounded (earthed) 3-pin outlet. Do not disable the power cord grounding pin, for example, by attaching a 2-pin adapter. The grounding pin is an important safety feature.

EU Declaration of Conformity

This device complies with the requirements set out in the Council Directive on the Approximation of the Laws of the Member States relating to Electromagnetic Compatibility (2014/30/EU), Low-voltage Directive (2014/35/EU), RoHS directive (2011/65/EU).

This product has been tested and found to comply with the harmonized standards for Information Technology Equipment, these harmonized standards published under Directives of Official Journal of the European Union.

ESD Warnings

When user close to the monitor may cause the equipment discharge and reboot to the display of main menu while USB media is

playing.

Warning:

This equipment is compliant with Class A of EN55032/CISPR 32. In a residential environment this equipment may cause radio interference.

Federal Communications Commission (FCC) Notice (U.S. Only)



NOTE: This equipment has been tested and found to comply with the limits for a Class A digital device, pursuant to part 15 of the FCC Rules. These limits are designed to provide reasonable protection against harmful interference when the equipment is operated in a commercial environment. This equipment generates, uses, and can radiate radio frequency energy and, if not installed and used in accordance with the instruction manual, may cause harmful interference to radio communications. Operation of this equipment in a residential area is likely to cause harmful interference in which case the user will be required to correct the interference at his own expense.



Changes or modifications not expressly approved by the party responsible for compliance could void the user's authority to operate the equipment.

Use only an RF shielded cable that was supplied with the display when connecting this display to a computer device. To prevent damage which may result in fire or shock hazard, do not expose this appliance to rain or excessive moisture.

This device complies with Part 15 of the FCC Rules. Operation is subject to the following two conditions: (1) This device may not cause harmful interference, and (2) this device must accept any interference received, including interference that may cause undesired operation.

Envision Peripherals Inc.
490 N McCarthy Blvd, Suite #120
Milpitas, CA 95035
USA

Europe Statement

IMPORTANT NOTE:

The device is restricted to indoor use only when operating in the 5150 to 5350MHz frequency range. (for 5G product only)

| | | | | | | | |
|---|----|----|----|----|----|----|--------|
|  | AT | BE | BG | HR | CY | CZ | DK |
| | EE | FI | FR | DE | EL | HU | IE |
| | IT | LV | LT | LU | MT | NL | PL |
| | PT | RO | SK | SI | ES | SE | UK(NI) |
| | UK | | | | | | |

Radiation Exposure Statement:

This equipment complies with CE radiation exposure limits set forth for an uncontrolled environment. This equipment should be installed and operated with minimum distance 20cm between the radiator & body.

The frequency, mode and the maximum transmitted power in EU are listed below:

2400-2483.5MHz: < 20 dBm (EIRP) (for 2.4G product only)

5150-5250MHz: < 23 dBm (EIRP)

5250-5350MHz: < 23 dBm (EIRP)

5470-5725MHz: < 30 dBm (EIRP)

5725-5825MHz: < 13.98 dBm (EIRP)

Taiwan:**低功率電波輻射性電機管理辦法**

第十二條 經型式認證合格之低功率射頻電機，非經許可，公司、商號或使用者均不得擅自變更頻率、加大功率或變更原設計之特性及功能。

第十四條 低功率射頻電機之使用不得影響飛航安全及干擾合法通信；經發現有干擾現象時，應立即停用，並改善至無干擾時方得繼續使用。

前項合法通信，指依電信法規定作業之無線電通信。

低功率射頻電機須忍受合法通信或工業、科學及醫療用電波輻射性電機設備之干擾。

在 5.25-5.35 兆赫頻帶內操作之無線資訊傳輸設備，限於室內使用。應避免影響附近雷達系統之操作。

FCC/ISED/CE-RED Caution:

Any changes or modifications not expressly approved by the party responsible for compliance could void the user's authority to operate this equipment.

This transmitter must not be co-located or operating in conjunction with any other antenna or transmitter.

Operations in the 5GHz products are restricted to indoor usage only.

Déclaration d'exposition aux radiations:

Cet équipement est conforme aux limites d'exposition aux rayonnements ISED établies pour un environnement non contrôlé. Cet équipement doit être installé et utilisé avec un minimum de 20cm de distance entre la source de rayonnement et votre corps.

Canada:

Industry Canada statement:

This device complies with RSS-247 of the Industry Canada Rules. Operation is subject to the following two conditions: (1) This device may not cause harmful interference, and (2) this device must accept any interference received, including interference that may cause undesired operation.

Ce dispositif est conforme à la norme CNR-247 d'Industrie Canada applicable aux appareils radio exempts de licence. Son fonctionnement est sujet aux deux conditions suivantes: (1) le dispositif ne doit pas produire de brouillage préjudiciable, et (2) ce dispositif doit accepter tout brouillage reçu, y compris un brouillage susceptible de provoquer un fonctionnement indésirable.

Radiation Exposure Statement:

This equipment complies with ISED radiation exposure limits set forth for an uncontrolled environment. This equipment should be installed and operated with minimum distance 20cm between the radiator & your body.

Déclaration d'exposition aux radiations: Cet équipement est conforme aux limites d'exposition aux rayonnements ISED établies pour un environnement non contrôlé. Cet équipement doit être installé et utilisé avec un minimum de 20 cm de distance entre la source de rayonnement et votre corps.

Polish Center for Testing and Certification Notice

The equipment should draw power from a socket with an attached protection circuit (a three-prong socket). All equipment that works together (computer, display, printer, and so on) should have the same power supply source.

The phasing conductor of the room's electrical installation should have a reserve short-circuit protection device in the form of a fuse with a nominal value no larger than 16 amperes (A).

To completely switch off the equipment, the power supply cable must be removed from the power supply socket, which should be located near the equipment and easily accessible.

A protection mark "B" confirms that the equipment is in compliance with the protection usage requirements of standards PN-93/T-42107 and PN-89/E-06251.

Wymagania Polskiego Centrum Badań i Certyfikacji

Urządzenie powinno być zasilane z gniazda z przyłączonym obwodem ochronnym (gniazdo z kolkiem). Współpracujące ze sobą urządzenia (komputer, monitor, drukarka) powinny być zasilane z tego samego źródła.

Instalacja elektryczna pomieszczenia powinna zawierać w przewodzie fazowym rezerwową ochronę przed zwarciami, w postaci bezpiecznika o wartości znamionowej nie większej niż 16A (amperów).

W celu całkowitego wyłączenia urządzenia z sieci zasilania, należy wyjąć wtyczkę kabla zasilającego z gniazdka, które powinno znajdować się w pobliżu urządzenia i być łatwo dostępne.

Znak bezpieczeństwa "B" potwierdza zgodność urządzenia z wymaganiami bezpieczeństwa użytkownika zawartymi w PN-93/T-42107 i PN-89/E-06251.

Pozostałe instrukcje bezpieczeństwa

- Nie należy używać wtyczek adapterowych lub usuwać kolka obwodu ochronnego z wtyczki. Jeżeli konieczne jest użycie przedłużacza to należy użyć przedłużacza 3-żyłowego z prawidłowo połączonym przewodem ochronnym.
- System komputerowy należy zabezpieczyć przed nagłymi, chwilowymi wzrostami lub spadkami napięcia, używając eliminatora przepięć, urządzenia dopasowującego lub bezzakłócenowego źródła zasilania.
- Należy upewnić się, aby nic nie leżało na kablach systemu komputerowego, oraz aby kable nie były umieszczone w miejscu, gdzie można byłoby na nie nadeptywać lub potykać się o nie.
- Nie należy rozlewać napojów ani innych płynów na system komputerowy.
- Nie należy wpychać żadnych przedmiotów do otworów systemu komputerowego, gdyż może to spowodować pożar lub porażenie prądem, poprzez zwarcie elementów wewnętrznych.
- System komputerowy powinien znajdować się z dala od grzejników i źródeł ciepła. Ponadto, nie należy blokować otworów wentylacyjnych. Należy unikać kładzenia luźnych papierów pod komputer oraz umieszczania komputera w ciasnym miejscu bez możliwości cyrkulacji powietrza wokół niego.

Electric, Magnetic and Electromagnetic Fields ("EMF")

1. We manufacture and sell many products targeted at consumers, which, like any electronic apparatus, in general have the ability to emit and receive electromagnetic signals.
2. One of our leading Business Principles is to take all necessary health and safety measures for our products, to comply with all applicable legal requirements and to stay well within the EMF standards applicable at the time of producing the products.
3. We are committed to develop, produce and market products that cause no adverse health effects.
4. We confirm that if its products are handled properly for their intended use, they are safe to use according to scientific evidence available today.
5. We play an active role in the development of international EMF and safety standards, enabling us to anticipate further developments in standardization for early integration in its products.

Information for U.K. only

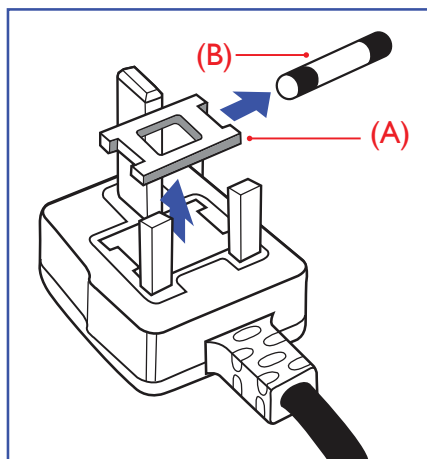

WARNING - THIS APPLIANCE MUST BE EARTHED.

Important:

This apparatus is supplied with an approved moulded 13A plug. To change a fuse in this type of plug proceed as follows:+

1. Remove fuse cover and fuse.
2. Fit new fuse which should be a BS 1362 5A, A.S.T.A. or BSI approved type.
3. Refit the fuse cover.

If the fitted plug is not suitable for your socket outlets, it should be cut off and an appropriate 3-pin plug fitted in its place.

If the mains plug contains a fuse, this should have a value of 5A. If a plug without a fuse is used, the fuse at the distribution board should not be greater than 5A.

NOTE: The severed plug must be destroyed to avoid a possible shock hazard should it be inserted into a 13A socket elsewhere.

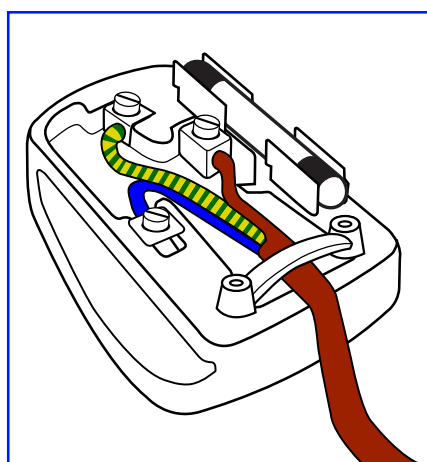

How to connect a plug

The wires in the mains lead are coloured in accordance with the following code:

BLUE - "NEUTRAL" ("N")

BROWN - "LIVE" ("L")

GREEN & YELLOW - "EARTH" ("E")

1. The GREEN & YELLOW wire must be connected to the terminal in the plug which is marked with the letter "E" or by the Earth symbol or coloured GREEN or GREEN & YELLOW.
2. The BLUE wire must be connected to the terminal which is marked with the letter "N" or coloured BLACK.
3. The BROWN wire must be connected to the terminal which marked with the letter "L" or coloured RED.

Before replacing the plug cover, make certain that the cord grip is clamped over the sheath of the lead - not simply over the three wires.

North Europe (Nordic Countries) Information

Placering/Ventilation

VARNING:

FÖRSÄKRA DIG OM ATT HUVUDBRYTARE OCH UTTAG ÄR LÄTÅTKOMLIGA, NÄR DU STÄLLER DIN UTRUSTNING PÅ PLATS.

Placering/Ventilation

ADVARSEL:

SØRG VED PLACERINGEN FOR, AT NETLEDNINGENS STIK OG STIKKONTAKT ER NEMT TILGÆNGLIGE.

Paikka/Ilmankierto

VAROITUS:

SIVOITA LAITE SITEN, ETTÄ VERKKOJOHTO VOIDAAN TARVITTAESSA HELPOSTI IRROTTAA PISTORASIESTA.

Plassering/Ventilasjon

ADVARSEL:

NÅR DETTE UTSTYRET PLASSERES, MÅ DU PASSE PÅ AT KONTAKTENE FOR STØMTILFØRSEL ER LETTE Å NÅ.

China RoHS

根据中国大陆《电器电子产品有害物质限制使用管理办法》，以下部分列出了本产品中可能包含的有害物质的名称和含量。

| 部件名称 | 有害物质 | | | | | |
|---------|-----------|-----------|-----------|-----------------|---------------|-----------------|
| | 铅 (Pb) | 汞 (Hg) | 镉 (Cd) | 六价铬 (Cr(VI)) | 多溴联苯 (PBB) | 多溴二苯醚 (PBDE) |
| 外壳 | ○ | ○ | ○ | ○ | ○ | ○ |
| 液晶显示屏 | X | ○ | ○ | ○ | ○ | ○ |
| 电路板组件* | X | ○ | ○ | ○ | ○ | ○ |
| 电源适配器 | X | ○ | ○ | ○ | ○ | ○ |
| 电源线/连接线 | X | ○ | ○ | ○ | ○ | ○ |
| 遥控器 | X | ○ | ○ | ○ | ○ | ○ |

本表格依据SJ/T 11364 的规定编制。

*: 电路板组件包括印刷电路板及其构成的零部件，如电阻、电容、集成电路、连接器等。

○: 表示该有害物质在该部件所有均质材料中的含量均在 GB/T 26572规定的限量要求以下。

X: 表示该有害物质至少在该部件的某一均质材料中的含量超出GB/T 26572规定的限量要求。

上表中打“X”的部件，应功能需要，部分有害物质含量超出GB/T 26572规定的限量要求，但符合欧盟RoHS法规要求（属于豁免部分）。

备注：上表仅做为范例，实际标示时应依照各产品的实际部件及所含有害物质进行标示。



环保使用期限

此标识指期限（十年），电子电气产品中含有的有害物质在正常使用的条件下不会发生外泄或突变，电子电气产品用户使用该电子电气产品不会对环境造成严重污染或对其人身、财产造成严重损害的期限。

《废弃电器电子产品回收处理管理条例》提示性说明

为了更好地关爱及保护地球，当用户不再需要此产品或产品寿命终止时，请遵守国家废弃电器电子产品回收处理相关法律法规，将其交给当地具有国家认可的回收处理资质的厂商进行回收处理，不当利用或者处置可能会对环境和人类健康造成影响。

警告

此为 A 级产品。在生活环境中，该产品可能会造成无线电干扰。在这种情况下，可能需要用户对干扰采取切实可行的措施。

| 單元 | 限用物質及其化學符號 | | | | | |
|--|------------|-----------|-----------|----------------------------|---------------|-----------------|
| | 鉛 (Pb) | 汞 (Hg) | 鎘 (Cd) | 六價鉻 (Cr ⁺⁶) | 多溴聯苯 (PBB) | 多溴二苯醚 (PBDE) |
| 塑料外框 | ○ | ○ | ○ | ○ | ○ | ○ |
| 後殼 | ○ | ○ | ○ | ○ | ○ | ○ |
| 液晶面板 | — | ○ | ○ | ○ | ○ | ○ |
| 電路板組件 | — | ○ | ○ | ○ | ○ | ○ |
| 底座 | ○ | ○ | ○ | ○ | ○ | ○ |
| 電源線 | — | ○ | ○ | ○ | ○ | ○ |
| 其他線材 | — | ○ | ○ | ○ | ○ | ○ |
| 遙控器 | — | ○ | ○ | ○ | ○ | ○ |
| 喇叭 (選配) | — | ○ | ○ | ○ | ○ | ○ |
| 風扇 (選配) | — | ○ | ○ | ○ | ○ | ○ |
| 備考1. “○” 係指該項限用物質之百分比含量未超出百分比含量基準值。 備考2. “—” 係指該項限用物質為排除項目。 | | | | | | |

警語：使用過度恐傷害視力。

注意事項：

- (1) 使用30分鐘請休息10分鐘。
- (2) 未滿2歲幼兒不看螢幕，2歲以上每天看螢幕不要超過1小時。

警告使用者：

此為甲類資訊技術設備，於居住環境中使用時，可能會造成射頻擾動，在此種情況下，使用者會被要求採取某些適當的對策。

Turkey RoHS:

Türkiye Cumhuriyeti: EEE Yönetmeliğine Uygundur

Ukraine RoHS:

Обладнання відповідає вимогам Технічного регламенту щодо обмеження використання деяких небезпечних речовин в електричному та електронному обладнанні, затвердженого постановою Кабінету Міністрів України від 3 грудня 2008 № 1057

End-of-Life Disposal

Your new Public Information Display contains materials that can be recycled and reused. Specialized companies can recycle your product to increase the amount of reusable materials and to minimize the amount to be disposed of.

Please find out about the local regulations on how to dispose of your old display from your local Philips dealer.

(For customers in Canada and U.S.A.)

This product may contain lead and/or mercury. Dispose of in accordance to local-state and federal regulations. For additional information on recycling contact www.eia.org (Consumer Education Initiative)

Waste Electrical and Electronic Equipment-WEEE

Attention users in European Union private households



This marking on the product or on its packaging illustrates that, under European Directive 2012/19/EU governing used electrical and electronic appliances, this product may not be disposed of with normal household waste. You are responsible for disposal of this equipment through a designated waste electrical and electronic equipment collection. To determine the locations for dropping off such waste electrical and electronic, contact your local government office, the waste disposal organization that serves your household or the store at which you purchased the product.

Attention users in United States:

Please dispose of according to all Local, State and Federal Laws. For the disposal or recycling information, contact: www.mygreenelectronics.com or www.eiae.org.

End of Life Directives-Recycling



Your new Public Information Display contains several materials that can be recycled for new users.

Please dispose of according to all Local, State, and Federal laws.

Restriction on Hazardous Substances statement (India)

This product complies with the “E-Waste (Management) Rules, 2016” CHAPTER V, rule 16, sub-rule (1) . Whereas New Electrical and Electronic Equipment and their components or consumables or parts or spares do not contain Lead, Mercury, Cadmium, Hexavalent Chromium, polybrominated biphenyls and polybrominated diphenyl ethers beyond a maximum concentration value of 0.1% by weight in homogenous materials for lead, mercury, hexavalent chromium, polybrominated biphenyls and polybrominated diphenyl ethers and of 0.01% by weight in homogenous materials for cadmium. except of exemptions set in Schedule 2 of the Rule.

E-Waste Declaration for India

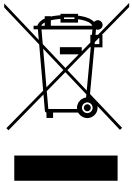

This symbol on the product or on its packaging indicates that this product must not be disposed of with your other household waste. Instead it is your responsibility to dispose of your waste equipment by handing it over to a designated collection point for the recycling of waste electrical and electronic equipment . The separate collection and recycling of your waste equipment at the time of disposal will help to conserve natural resources and ensure that it is recycled in a manner that protects human health and the environment. For more information about E -waste please visit <http://www.india.philips.com/about/sustainability/recycling/index.page> and to know where you can drop off your waste equipment for recycling in India please contact on below given contact details.

Helpline number: 1800-425-6396 (Monday to Saturday, 9 a.m. to 5:30 pm)

E-mail: india.callcentre@tpv-tech.com

Batteries



For EU: The crossed-out wheeled bin implies that used batteries should not be put to the general household waste! There is a separate collection system for used batteries, to allow proper treatment and recycling in accordance with legislation.

Please contact your local authority for details on the collection and recycling schemes.

For Switzerland: The used battery is to be returned to the selling point.

For other non-EU countries: Please contact your local authority for correct method of disposal of the used battery.

According to EU directive 2006/66/EC, the battery can't be disposed improperly. The battery shall be separated to collect by local service.



Após o uso, as pilhas e/ou baterias deverão ser entregues ao estabelecimento comercial ou rede de assistência técnica autorizada.

| | |
|-----------------------------------|--|
| Information for EAC |  |
| Month and year of manufacturing | please refer information in Rating label. |
| Name and location of manufacturer | ООО "Профтехника" Адрес: 3-й Проезд Марьиной роци, 40/1 офис 1. Москва, 127018, Россия |
| Importer and information | Наименование организации: ООО "Профтехника" Адрес: 3-й Проезд Марьиной роци, 40/1 офис 1. Москва, 127018, Россия Контактное лицо: Наталья Астафьева, +7 495 640 20 20 nat@profdisplays.ru |

Table Of Contents

| | | | | | |
|------|---|----|-------|---|----|
| 1. | Unpacking and Installation | 1 | 7. | Supported Media Formats | 50 |
| 1.1. | Unpacking..... | 1 | 8. | Input Mode..... | 51 |
| 1.2. | Package Contents | 1 | 9. | Pixel Defect Policy | 52 |
| 1.3. | Installation Notes..... | 1 | 9.1. | Pixels and Sub-Pixels | 52 |
| 1.4. | Mounting on a Wall..... | 2 | 9.2. | Types of Pixel Defects + Dot Definition | 52 |
| 1.5. | Mounting in Portrait Orientation..... | 3 | 9.3. | Bright Dot Defects..... | 52 |
| 2. | Parts and Functions..... | 4 | 9.4. | Dark Dot Defects | 53 |
| 2.1. | Control Panel..... | 4 | 9.5. | Proximity of Pixel Defects..... | 53 |
| 2.2. | Input/Output Terminals..... | 5 | 9.6. | Pixel Defect Tolerances | 53 |
| 2.3. | Remote Control..... | 6 | 9.7. | MURA..... | 53 |
| 2.4. | USB Cover..... | 12 | 10. | Cleaning and Troubleshooting..... | 54 |
| 2.5. | Installing the 4G module..... | 13 | 10.1. | Cleaning | 54 |
| 3. | Connecting External Equipment | 14 | 10.2. | Troubleshooting..... | 55 |
| 3.1. | Connecting External Equipment (DVD/ VCR/VCD)..... | 14 | 11. | Warranty Statement | 56 |
| 3.2. | Connecting a PC..... | 14 | 12. | Technical Specifications..... | 57 |
| 3.3. | Connecting Multiple Displays in a Daisy- chain Configuration | 15 | | | |
| 3.4. | IR connection..... | 15 | | | |
| 3.5. | IR Pass-through Connection | 16 | | | |
| 3.6. | Wire-connecting to Network | 16 | | | |
| 4. | Operation | 17 | | | |
| 4.1. | Watch the Connected Video Source | 17 | | | |
| 4.2. | Change Picture Format..... | 17 | | | |
| 4.3. | Overview..... | 17 | | | |
| 4.4. | Media Player..... | 19 | | | |
| 4.5. | Browser | 23 | | | |
| 4.6. | PDF Player | 27 | | | |
| 4.7. | CMND & Play..... | 30 | | | |
| 4.8. | Custom App | 30 | | | |
| 5. | Setting UI..... | 32 | | | |
| 5.1. | Settings | 32 | | | |
| 6. | OSD Menu | 44 | | | |
| 6.1. | Navigating the OSD Menu..... | 44 | | | |
| 6.2. | OSD Menu Overview..... | 44 | | | |

1. Unpacking and Installation

1.1. Unpacking

- This product is packed in a carton, together with the standard accessories.
- Any other optional accessories will be packed separately.
- As this product is high and heavy, the operation of moving the device is recommended to be performed by two technicians.
- After opening the carton, ensure that the contents are complete and in good condition.

1.2. Package Contents

Please verify that you received the following items with your package content:

- LCD display
- Remote control with AAA batteries
- Quick start guide
- Power cord
- RS232 cable
- RS232 daisy chain cable
- IR sensor cable
- USB cover x1
- Philips logo plate



LCD display

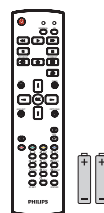

Remote Control and AAA Batteries

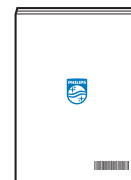

Quick start guide

* The supplied power cord varies depending on destination.



Power Cord

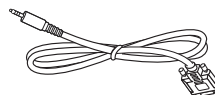

RS232 Cable

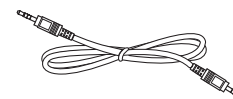

RS232 Daisy Chain Cable

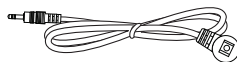

IR Sensor Cable



Philips logo plate

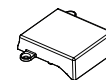

USB Cover x 1

* Differences according to regions.

* Display design and accessories may differ from those illustrated above.

NOTES:

- For all other regions, apply a power cord that conforms to the AC voltage of the power socket and has been approved by and complies with the safety regulations of the particular country.
- You might like to save the package box and packing material for shipping the display.

1.3. Installation Notes

- Only use the power cable provided with this product. If an extension cord is required, please consult your service agent.
- The product should be installed on a flat surface, or the product may tip over. Leave a space between the rear of the product and the wall for proper ventilation. Do not install the product in a kitchen, bathroom or a place exposed to moisture, failure to do so may shorten the life of the internal parts.
- Do not install the product where it is 3000m and higher in altitude. Failure to do so may result in malfunctions.

1.4. Mounting on a Wall

To mount this display on a wall, a standard wall-mounting kit (commercially available) is required. It is recommended that you use a mounting interface that complies with TUV-GS and /or UL1678 standard in North America.

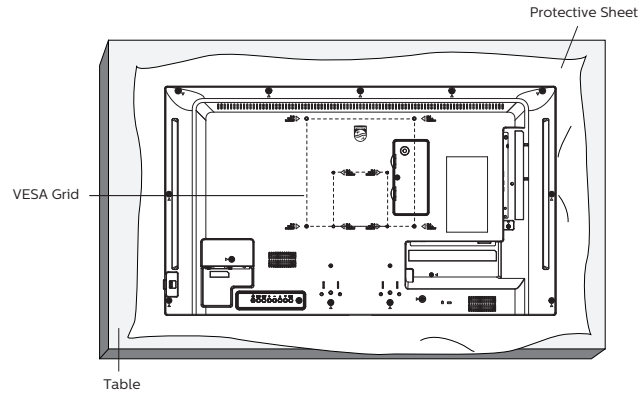

1. Spread a protective sheet which was wrapped around the display when it was packed on a flat surface. Lay the display face-down on the protective sheet to facilitate your operation without scratching the screen.
2. Ensure that you have all accessories necessary for any type of mounting (wall-mounting, ceiling mounting etc).
3. Follow the instructions that come with the base mounting kit. Failure to follow correct mounting procedures could result in damage to the equipment or injury to the user or installer. Product warranty does not cover damage caused by improper installation.
4. For the wall-mounting kit, use M4 mounting screws (with a length 10 mm longer than the thickness of the mounting bracket) and tighten them securely.

1.4.1. VESA Grid

| | |
|-------------------|--|
| 32BDL4550D | 100(H) x 100(V) mm 200(H) x 200(V) mm |
|-------------------|--|

Caution:

To prevent the display from falling:

- For wall or ceiling mounting, we recommend that you install the display with metal brackets which are commercially available. For detailed instructions about the installation, refer to the guide that come with the bracket.
- To prevent the display from falling in case of earthquake or other natural disaster, please contact the manufacturer of the bracket for the mounting location.

Required space for ventilation

Leave a space of 100 mm at the top, rear, right and left for ventilation.

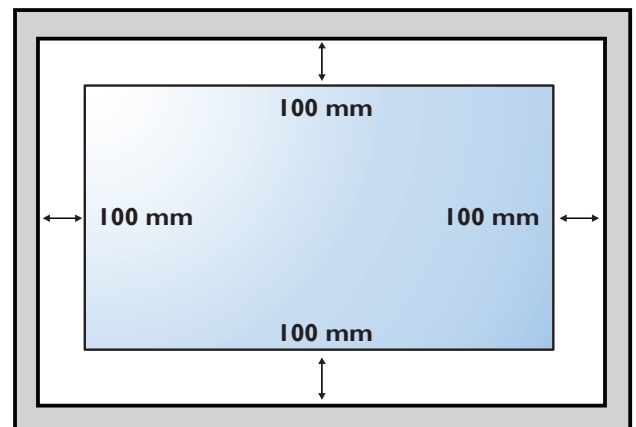

1.5. Mounting in Portrait Orientation

This display can be installed in portrait orientation.

Rotate the display 90 degrees clockwise. The “**PHILIPS**” logo should be on the left side when facing the display.

NOTE: The working hour in portrait mode is 18 hours per day.

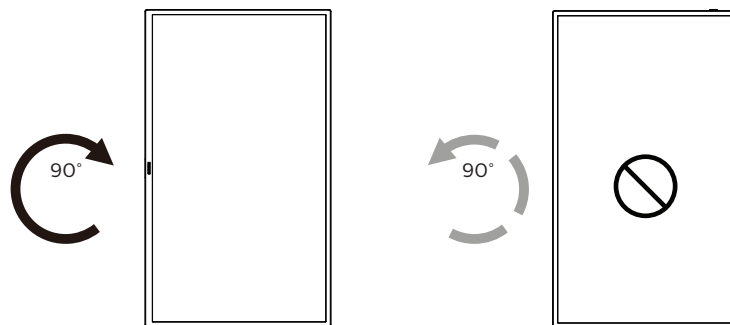

1.5.1. How to remove the logo plate

1. Prepare a piece of paper with a cutting area of logo as a protector to prevent the front bezel from scratching.
2. Use a knife and carefully remove the logo sticker with the paper placing beneath.
3. Tear off the logo sticker.

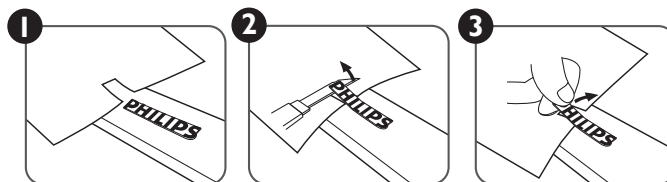

NOTE: We recommend you contact a professional technician when installing the display on a wall. We are not responsible for any damage to the product if the installation is not performed by a professional technician.

2. Parts and Functions

2.1. Control Panel

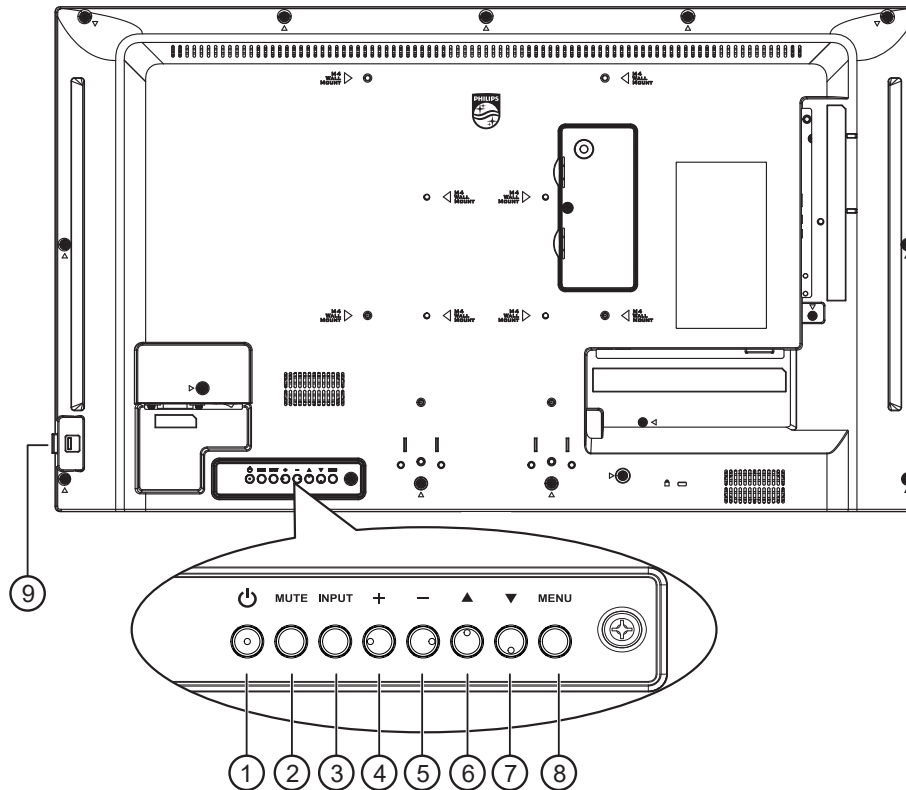

① [⏻] button

Press this button to turn the display On or turn the display to standby mode.

② [MUTE] button

Press this button to mute the sound or reactivate sound.

③ [INPUT] button

Choose the input source.

Confirm a selection in the OSD menu.

④ [+] button

Increase the adjustment while OSD menu is on, or increase the audio output level while OSD menu is off.

⑤ [-] button

Decrease the adjustment while OSD menu is on, or decrease the audio output level while OSD menu is off.

⑥ [▲] button

Move the selected item one level up while the OSD menu is On.

⑦ [▼] button

Move the selected item one level down while the OSD menu is On.

⑧ [MENU] button

Return to the previous menu while the OSD menu is On. This button can also be used to activate the OSD menu when the OSD menu is Off.

⑨ Remote control sensor and power status indicator

- Receives command signals from the remote control.
- Indicates the operating status of the display:
 - Lights green when the display is turned on.
 - Lights red when the display is in standby mode.
 - Lights amber when the display enters APM mode.
 - When {SCHEDULE} is enabled, the light blinks green and red.
 - If the light blinks red, it indicates that a failure has been detected.
 - Lights off when the main power of the display is turned off.

2.2. Input/Output Terminals

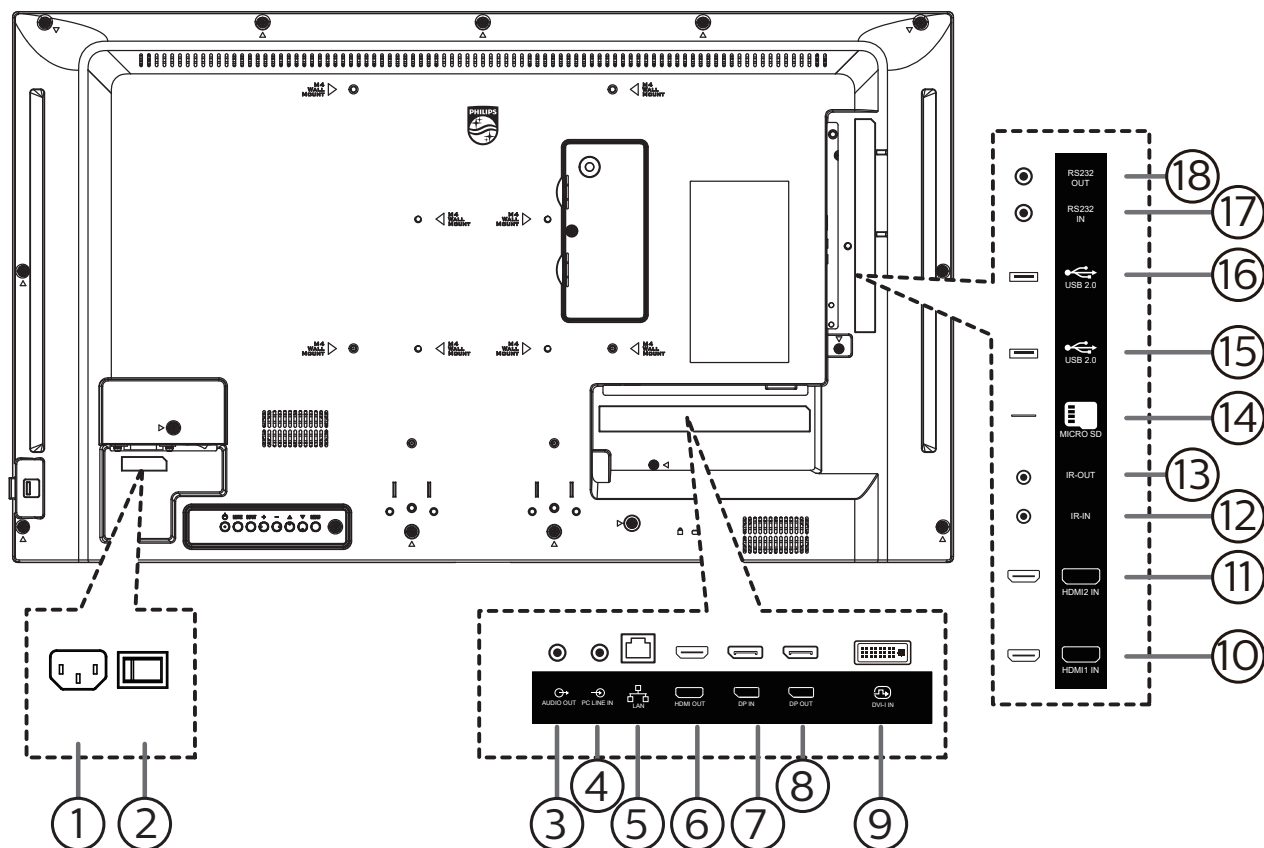

① AC IN

AC power input from the wall outlet.

② MAIN POWER SWITCH

Switch the main power between On and Off.

③ AUDIO OUT

Audio output to external AV device.

④ PC LINE IN

Audio input for VGA source (3.5mm stereo phone).

⑤ RJ-45 IN

LAN control function for the use of remote control signal from control center.

⑥ HDMI OUT

HDMI video/audio output.

⑦ DP IN / ⑧ DP OUT

DisplayPort video input / output.

⑨ DVI-I IN

DVI-I video input.

⑩ HDMI1 IN / ⑪ HDMI2 IN

HDMI video/audio input.

⑫ IR IN / ⑬ IR OUT

IR signal input / output for the loop-through function.

NOTES:

- This display's remote control sensor will stop working if the jack [IR IN] is connected.
- To remotely control your A/V device via this display, refer to page 16 for IR Pass Through connection.

⑭ Micro SD card slot

Insert a micro SD card.

⑮ USB 2.0 PORT / ⑯ USB 2.0 PORT

Connect your USB storage device and service port.

⑰ RS232 IN / ⑱ RS232 OUT

RS232 network input / output for the loop-through function.

2.3. Remote Control

2.3.1. General functions

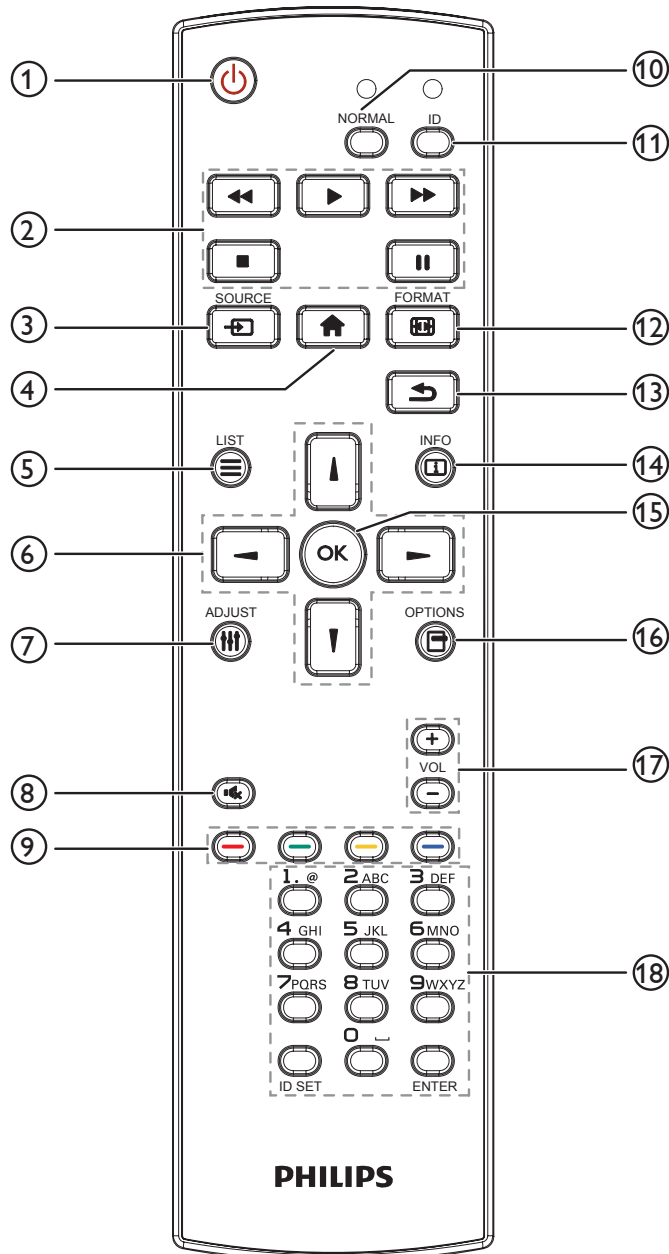

- ① **[POWER] POWER button**
Turn the display on or put the display to standby mode.
- ② **[PLAY] buttons**
Control playback of media files.
- ③ **[SOURCE] SOURCE button**
Choose input source. Press [▲] or [▼] button to choose from **USB, Network, HDMI 1, HDMI 2** or **DVI-I**. Press [OK] button to confirm and exit.
- ④ **[HOME] HOME button**
Access the OSD menu.
- ⑤ **[LIST] LIST button**
Reserved.
- ⑥ **[▲] [▼] [←] [→] NAVIGATION buttons**
Navigate through menus and choose items.
- ⑦ **[ADJUST] ADJUST button**
Access currently available options, picture and sound menu.
- ⑧ **[MUTE] MUTE button**
Press to turn the mute function on/off.
- ⑨ **[RED] [GREEN] [YELLOW] [BLUE] COLOR buttons**
Choose tasks or options.
- ⑩ **[NORMAL] NORMAL button**
Switch to normal mode.
- ⑪ **[ID] ID button**
Switch to ID mode.
- ⑫ **[FORMAT] FORMAT button**
Change zoom mode.
- ⑬ **[BACK] BACK button**
Return to the previous menu page or exit from the previous function.
- ⑭ **[INFO] INFO button**
Display information about current activity.
- ⑮ **[OK] OK button**
Confirm an entry or selection.
- ⑯ **[OPTIONS] OPTIONS button**
Access currently available options, picture and sound menu.
- ⑰ **[VOL+] [VOL-] VOLUME button**
Increase or decrease the volume level.
- ⑱ **[NUMERIC] NUMERIC buttons**
Enter text for network setting, and set up ID for ID mode.

2.3.2. ID Remote Control

Set the remote control ID if you intend to use this remote control on several different displays.

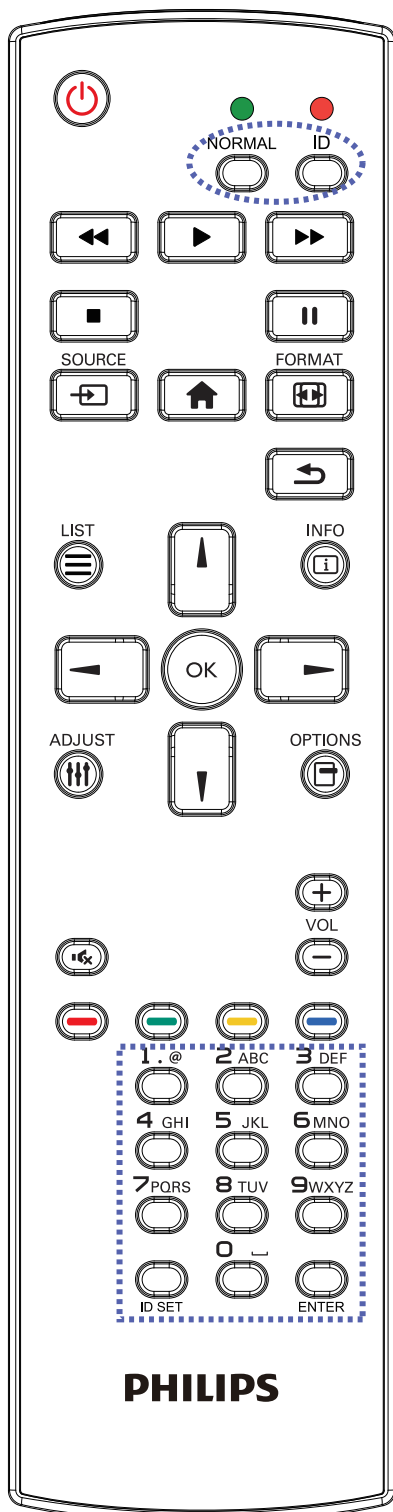

Press [ID] button. The red LED blinks twice.

1. Press [ID SET] button for more than 1 second to enter the ID Mode. The red LED lights up.
Press the [ID SET] button again to exit from ID mode. The red LED lights off.

Press the digit numbers [0] ~ [9] to select the display you want to control.

For example: press [0] and [1] for display No.1, press [1] and [1] for display No.11.

The numbers available are from [01] ~ [255].

2. Not pressing any button within 10 seconds will exit the ID Mode.
3. If a wrong button is pressed, wait 1 second after the red LED lights off and then lights up again, then press the correct digits again.
4. Press [ENTER] button to confirm. The red LED blinks twice and then lights off.

NOTE:

- Press [NORMAL] button. The green LED blinks twice, indicating the display is in normal operation.
- It is necessary to set up the ID number for each display before selecting its ID number.
- Use “||” (pause) key on the remote control to freeze the screen. Use “▶” (play) key on the remote control to unfreeze the screen.
- The “freeze” feature only can be adopted on “real” video sources like VGA, AV, YPbPr, HDMI, DVI, DP.
- Any operation on the remote control or video mode change will unfreeze the screen.

2.3.3. Remote Control buttons on Android source

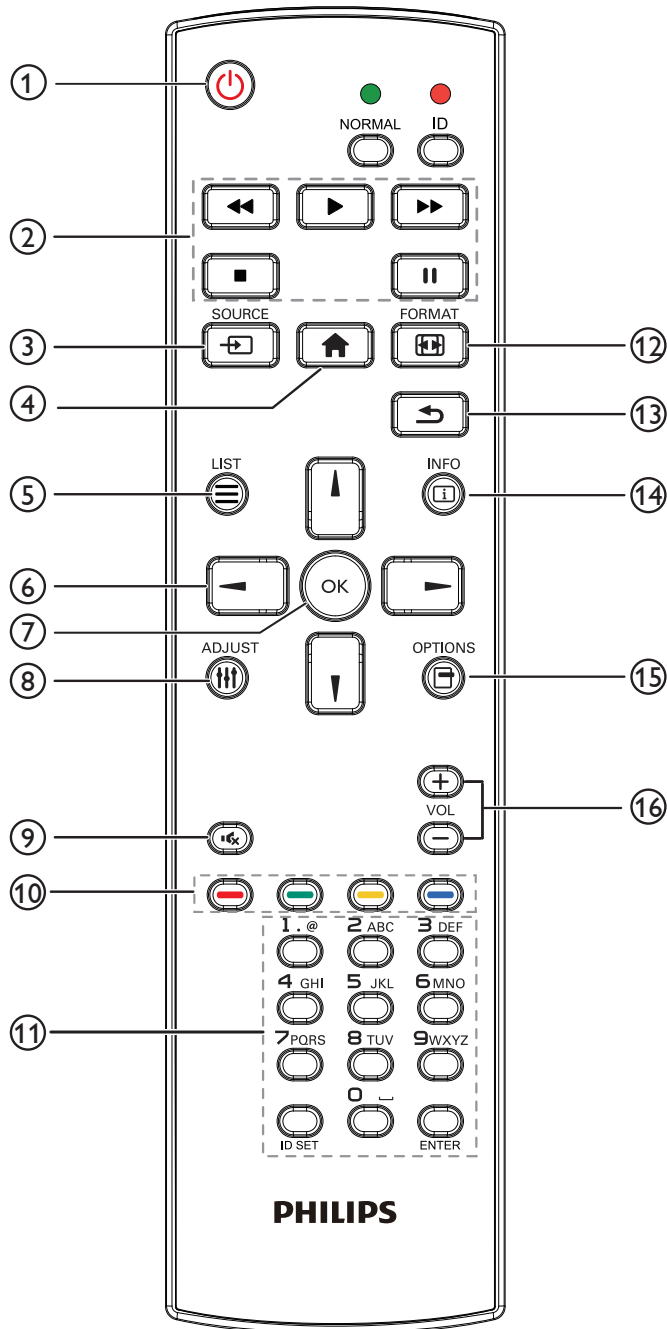

① [POWER] POWER button

Turn the display on or put the display to standby.
The button is only controlled by Scalar.

② [PLAY] buttons

1. Control playback of media(video/audio/picture) files.
There are 4 ways to play media files.

1) File Manager

Find the media file from the File Manager and select it to play.

2) Media Player -> Compose -> edit or add a new playlist -> choose any media files -> press  to play the media file directly.

3)Media Player -> Play -> choose non-empty play list
-> press  to play all the media files in the play list.

4) Set media playlist in Boot on Source or Schedule by OSD menu.

2. Play PDF file



There are 3 ways to play PDF files.

1) File Manager

Find the pdf file from the File Manager and select it to play.

2) PDF Player -> Play -> choose non-empty play list -> press  to play all the PDF files in the play list.

3) Set pdf playlist in Boot on Source or Schedule by OSD menu.

3. When playing PDF, video or music, press  to stop playing. Then if pressing  again, playing will be started from the beginning of the file.

4. When playing PDF, video or music, press  button to pause playing.

5. All media or pdf files should be put at the folder, which is named "philips" with sub-folder, under the root directory of the specified storage (internal/USB/SD Card). All sub-folders (video/photo/music/pdf) are named by media types and shouldn't be changed.

videos: {root dir of storage}/philips/video/

photos: {root dir of storage}/philips/photo/

music : {root dir of storage}/philips/music/

pdfs : {root dir of storage}/philips/pdf/

Note that the root directories of three storages are

Internal storage: /sdcard

USB storage: /mnt/usb_storage

SD card : /mnt/external_sd

③ SOURCE button

Choose input source.

The button is only controlled by Scalar.

④ HOME button

Access OSD menu.

The button is only controlled by Scalar.





⑤ LIST button

1. In the content of the web page, move the focus up to the next clickable items.

2. Move the focus up to the next control or widget such as buttons.

⑥ NAVIGATION buttons

1. Navigate through menus and choose items.

2. In the content of the web page, these buttons are to control the scroll bar of the screen. Press  or  to move vertical scroll bar up or down. Press  or  to move horizontal scroll bar left or right.

3. For PDF files,

Press  to go to the next page.

Press  to go to the previous page.

⑦ [OK] button

Confirm an entry or selection.

⑧ [||||] ADJUST button

1. In the content of the web page, move the focus down to the next clickable items.



2. Move the focus down to the next control or widget such as buttons.

⑨ [MUTE] MUTE button



Press to turn the mute function on/off.

The button is only controlled by Scalar.

⑩ [Red] [Green] [Yellow] [Blue] COLOR buttons

 : No function on Android source. These two buttons are only controlled by Scalar.

⑪ [Number/ ID SET/ ENTER] button

1. No functions for ID SET  and ENTER  on Android source. These buttons are only controlled by Scalar.

2. For PDF file, enter the page number by pressing number buttons and then press  button to jump to the specific page.

⑫ [FORMAT] FORMAT button

Change picture format. The button is only controlled by Scalar.

⑬ [BACK] BACK button

Return to the previous page or exit from the previous function.

⑭ [i] INFO button

1. Display information about current input signal. It is shown by Scalar.

2. Media Player -> Compose -> edit or add a new playlist -> choose any media files -> press  to show the information of the chosen media file.

⑮ [OPTIONS] OPTIONS button

Open toolbox in Media Player or PDF Player.

1. Media Player ->Compose -> Edit or add a new playlist -> press  to open toolbox. Toolbox will slide from the left side of the screen.

2. PDF Player ->Compose -> Edit or add a new playlist -> press  to open toolbox. Toolbox will slide from the left side of the screen.

⑯ [−] [+] VOLUME button

Adjust volume. The buttons are only controlled by Scalar.

2.3.4. Inserting the batteries in the remote control

The remote control is powered by two 1.5V AAA batteries.

To install or replace batteries:

1. Press and then slide the cover to open it.
2. Insert batteries with the correct polarity (+) and (-).
3. Replace the cover.

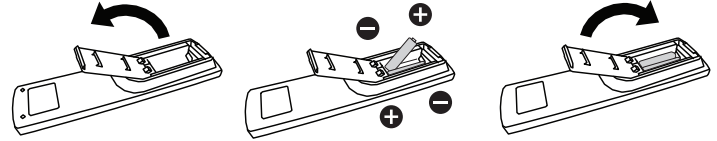

Caution:

Incorrect use of batteries may cause leakage or explosion. Be sure to follow the instructions below:

- Insert “AAA” batteries with the correct polarity (+ and -).
- Do not mix battery types.
- Do not use a new battery with a used one together. Otherwise, it may cause leakage or shorten the life of the batteries.
- Remove the dead batteries immediately to avoid battery leakage in the battery compartment. Do not touch exposed battery acid, as it may cause injury to your skin.
- Disposal of a battery into fire or a hot oven, or mechanically crushing or cutting of a battery, that can result in an explosion; leaving a battery in an extremely high temperature surrounding environment that can result in an explosion or the leakage of flammable liquid or gas; and a battery subjected to extremely low air pressure that may result in an explosion or the leakage of flammable liquid or gas.

NOTE: Remove the batteries from the battery compartment when not using for an extended period of time.

2.3.5. Handling the remote control

- Do not drop or apply shock to the remote control.
- Do not allow any liquid to get inside the remote control. If water has entered the remote control, wipe the remote control with a dry cloth immediately.
- Do not place the remote control near heat and steam sources.
- Do not attempt to disassemble the remote control, unless you need to place batteries in the remote control.

2.3.6. Operating range of the remote control

Pointing the remote control at the remote sensor on the display.

Use the remote control within 5 m from the sensor on the display at an angle of 20 degrees from the left and right.

NOTE:

- The remote control may not function properly when the remote control sensor on the display is under direct sunlight or strong illumination, or when an obstacle blocks the signal transmission.
- Use an IR sensor cable for better performance of the remote control. (Refer to 3.4. IR connection for details)

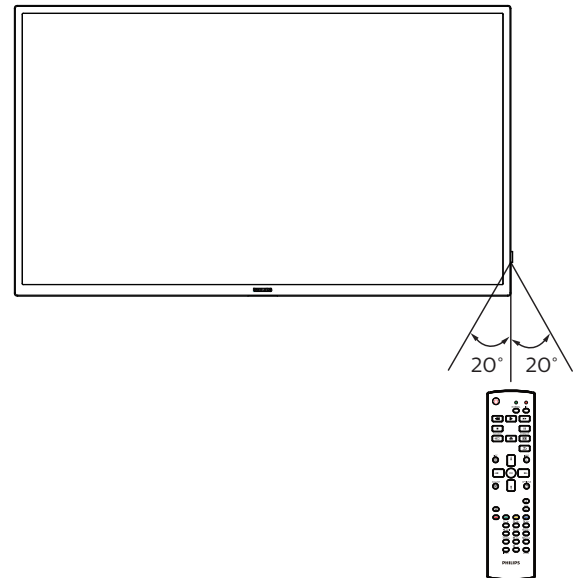

2.3.7. Using the remote sensor and power indicator

1. Push down the lens to have better remote control performance and make it easy to observe the power status.
2. Pull up the lens before mounting the display for video wall application.
3. Pull/push the lens until a click sound is heard.

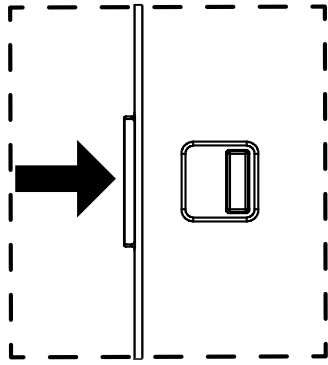

Push right to collapse the lens

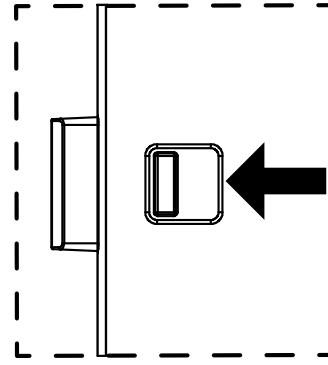

Push left to expand the lens

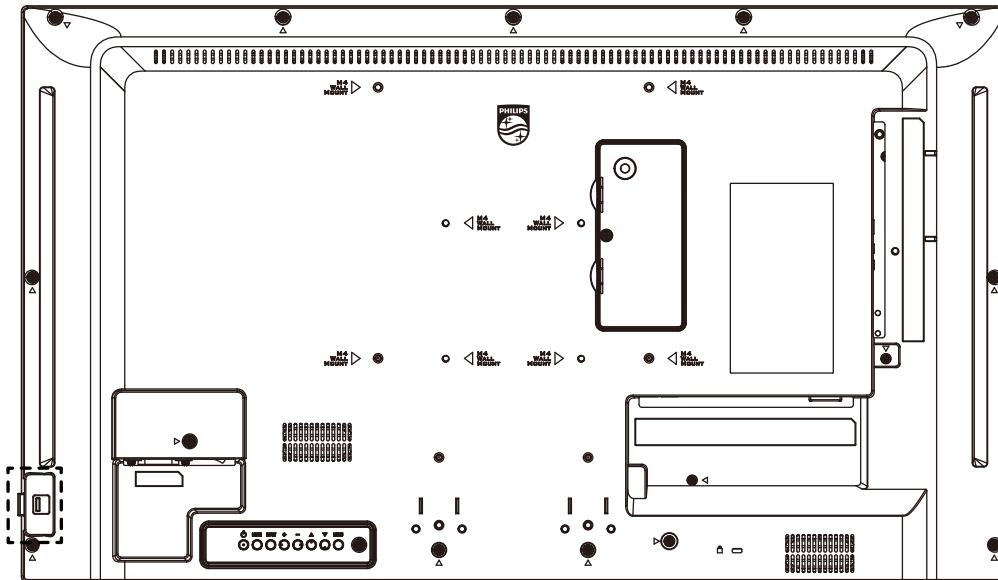

2.4. USB Cover

- Use the USB cover and screws to cover the USB stick.
 1. Install the USB stick.
 2. Install the USB cover.
 3. Use the screw in accessory to fix the USB cover.

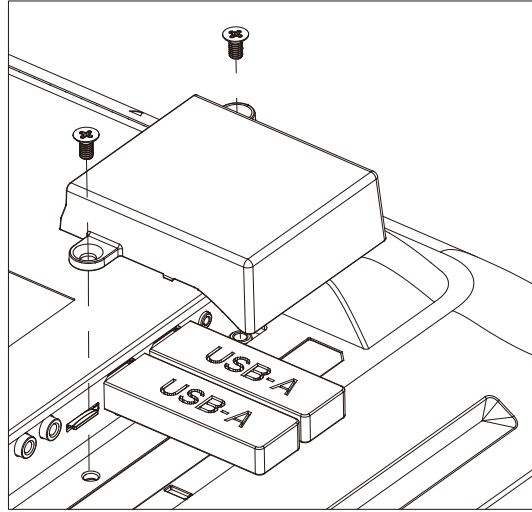

- Maximum USB stick size recommended: 20(W)x10(H)x60(L) mm

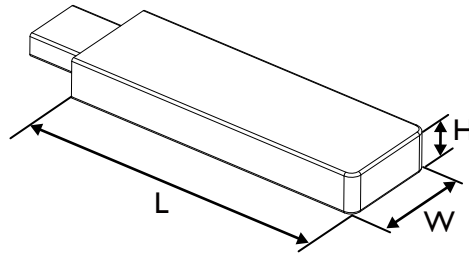

2.5. Installing the 4G module

1. Please consult a professional technician to install the 4G module.
2. Power off the display.
3. Loosen the screw on the service cover to take the service cover out. The 4G board is on the back side of the service cover. Flip over the service cover and ensure that the 4G cables are attached firmly to the 4G board. Careless operation may damage the 4G board.
4. Install the 4G module to the 4G board with two M2 screws.
5. Move the antenna from 4G board (position A) to 4G module (position B) as shown in diagram 3.
6. Install the service cover back to the display.

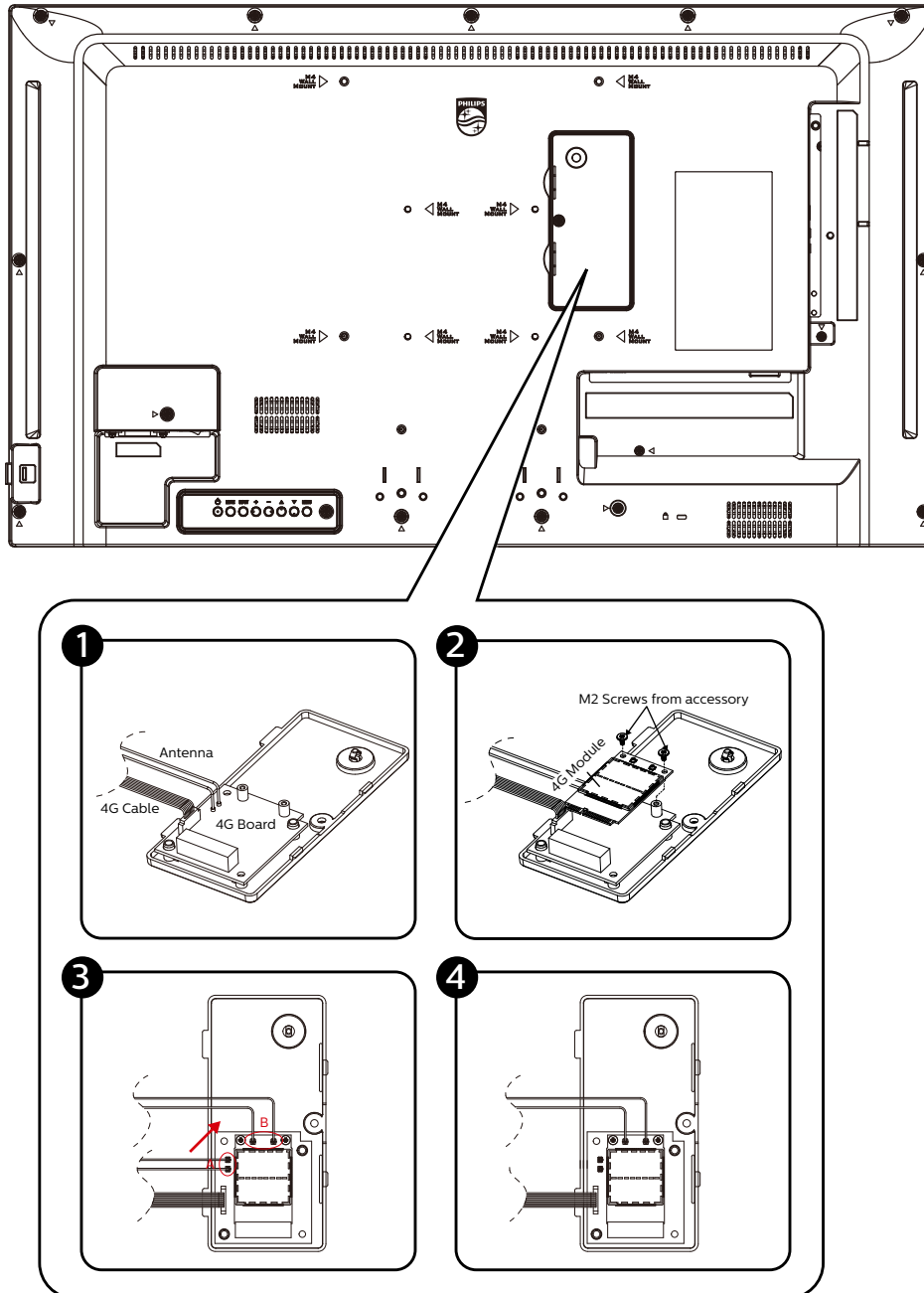

3. Connecting External Equipment

3.1. Connecting External Equipment (DVD/VCR/VCD)

3.1.1. Using HDMI video input

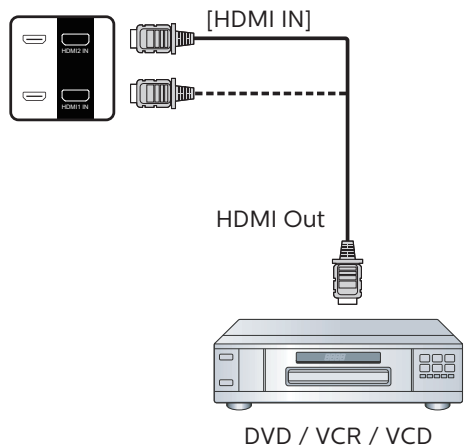

3.2. Connecting a PC

3.2.1. Using DVI input

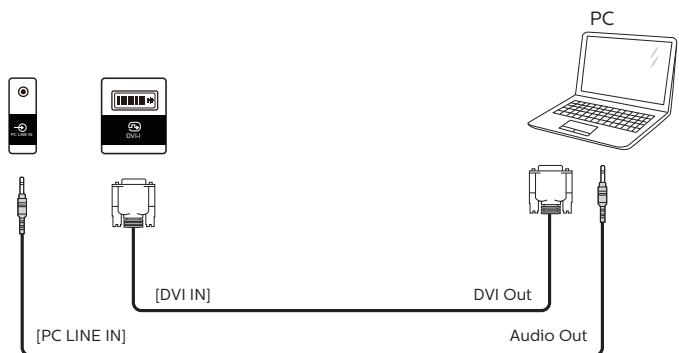

3.2.2. Using HDMI input

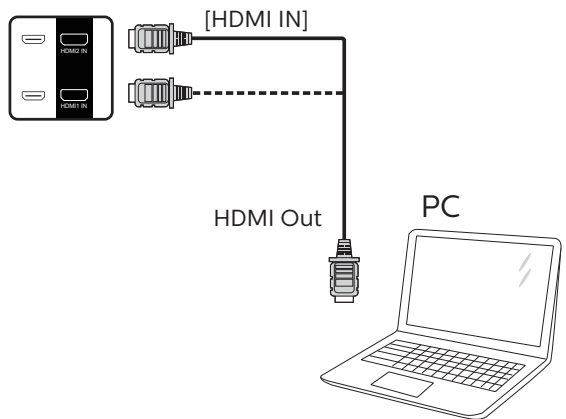

3.2.3. Using DP input

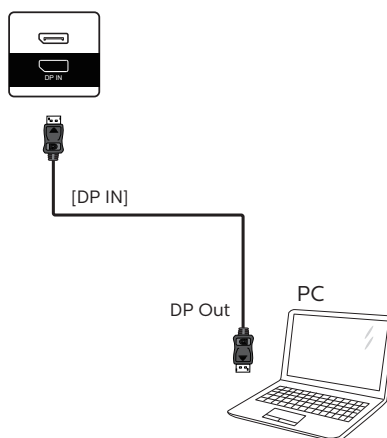

3.3. Connecting Multiple Displays in a Daisy-chain Configuration

You can interconnect multiple displays to create a daisy-chain configuration for applications such as a menu board.

3.3.1. Display control connection

Connect the [RS232C OUT] connector of DISPLAY 1 to the [RS232C IN] connector of DISPLAY 2.

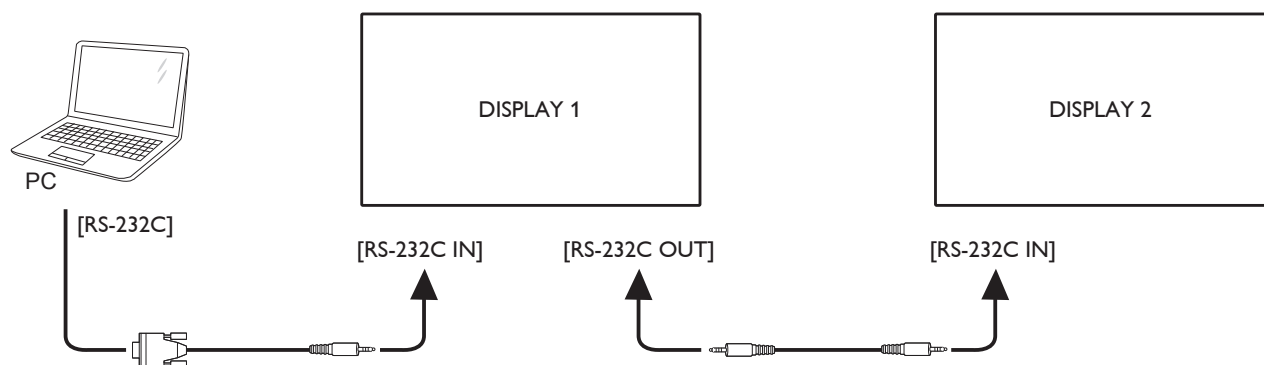

3.4. IR connection

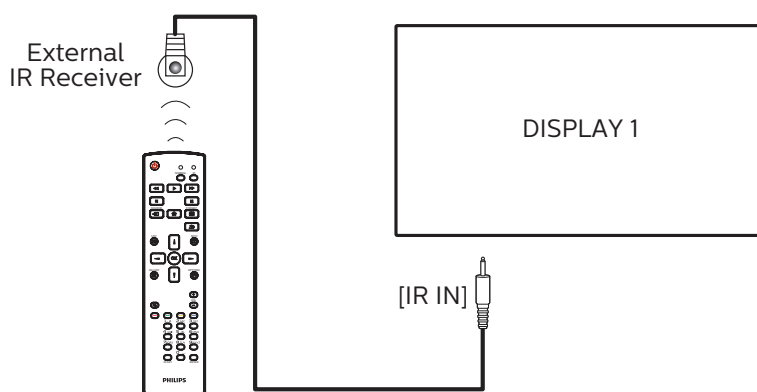

NOTE:

This display's remote control sensor will stop working if the [IR IN] is connected.

3.5. IR Pass-through Connection

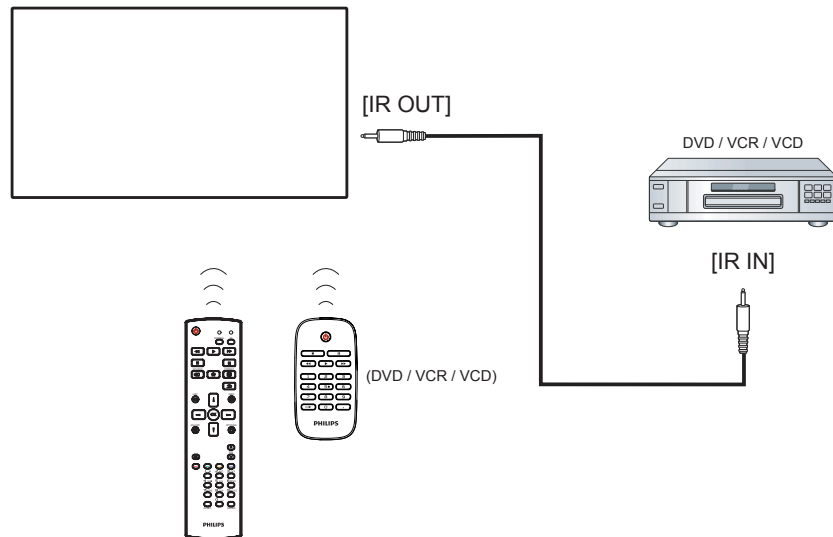

3.6. Wire-connecting to Network

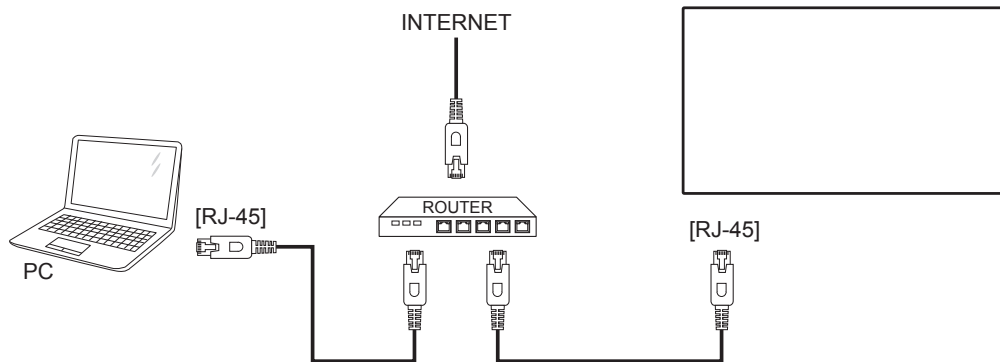

Network Settings:

1. Switch the router on and enable its DHCP setting.
2. Connect the router to this display with an Ethernet cable.
3. Press [**HOME**] HOME button on the remote control, then select **Setup**.
4. Select **Connect to network**, then press [**OK**] button.
5. Wait until this display finds the network connection.
6. If the "End User License Agreement" window prompts, accept the agreement.

NOTE: Connecting with a shielded CAT-5 Ethernet cable to comply with the EMC directive.

4. Operation

NOTE: The control button described in this section is mainly on the remote control unless specified otherwise.

4.1. Watch the Connected Video Source

1. Press **[SOURCE]** button.
2. Press **[▲]** or **[▼]** button to choose a device, then press **[OK]** button.

4.2. Change Picture Format

You can change the picture format to suit the video source. Each video source has its available picture formats.

The available picture formats depend on the video source:

1. Press **[FORMAT]** button to choose a picture format.
 - PC mode: {Full} / {4:3} / {Real} / {21:9} / {Custom}.
 - Video mode: {Full} / {4:3} / {Real} / {21:9} / {Custom}.

4.3. Overview

1. Android PD launcher:
 - Android PD launcher is a black page as shown below:

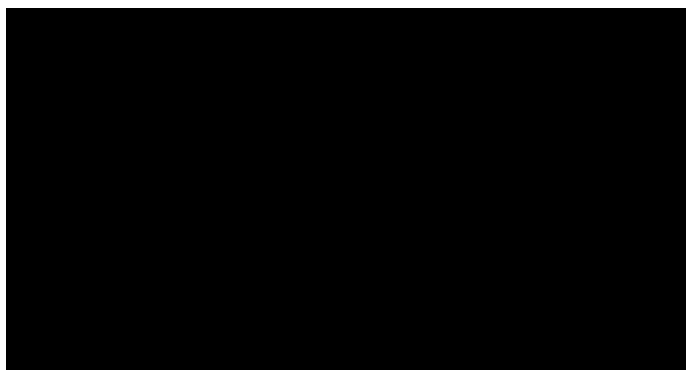

- Exit the App by pressing the back key, the screen will enter Android PD launcher.
- When you return to android PD launcher, the screen will show a hint image, this hint image appears for 5 seconds only.
- The hint image will notify you can press source key to change source.



2. Admin mode:
 - You can press “Home + 1888” to enter admin mode. Please make sure you see the Home OSD menu after

“Home” is pressed, and then press 1888 in sequence. Two continuous “Home” keys will not be a valid hotkey.

- In Admin mode, you will see five icons: “Settings”, “Apps”, “Network”, “Storage” and “Help”.
- When you leave from Admin mode, the system will return to last source.

Settings: go to settings app.

Apps: show all applications.

Network: set Wi-Fi, Ethernet

Storage: display current PD Android storage information.

Help: display the QR code to link to Philips support website.

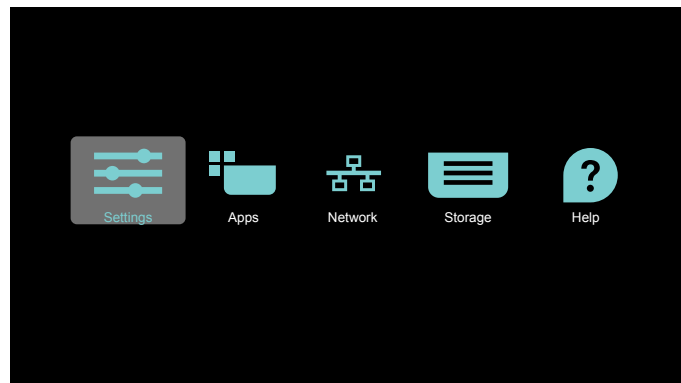

1) Settings:

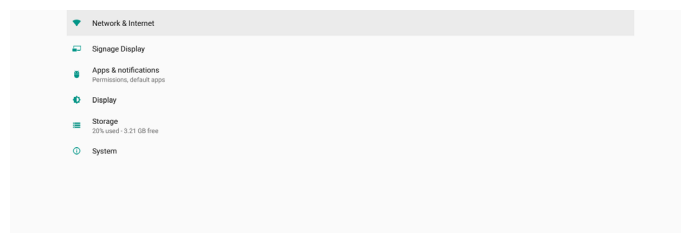

2) Application page:

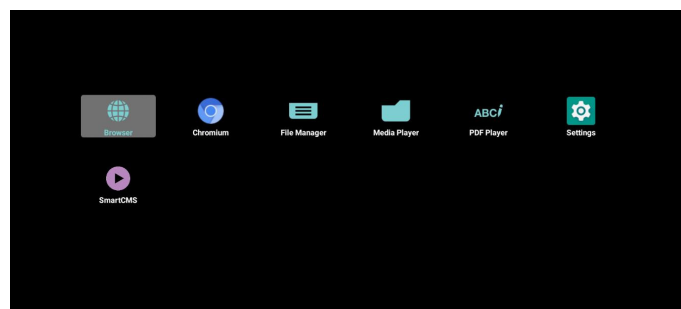

3) Network page

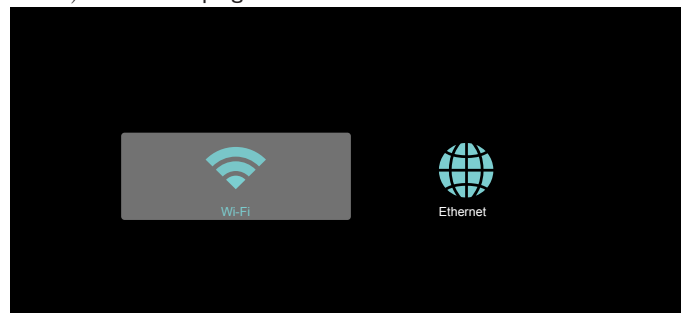

3.1) Ethernet page

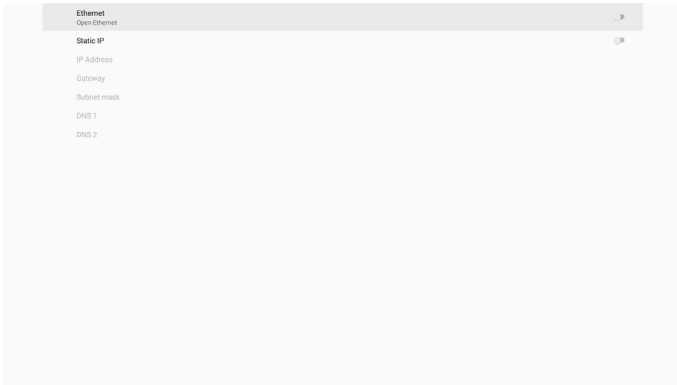

3.2) Wi-Fi



4) Storage:

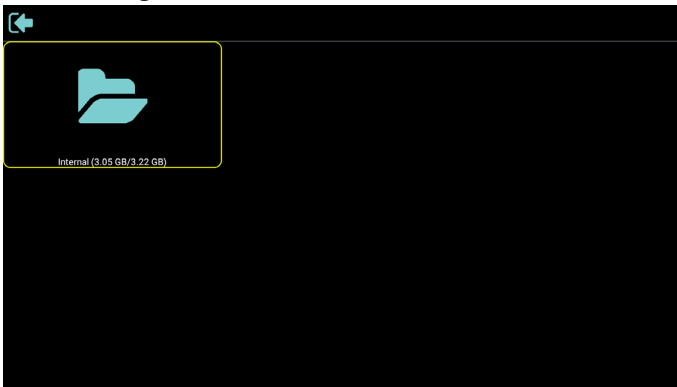

5) Help page:

Display the QR code to link to Philips support website.



4.4. Media Player

4.4.1. Settings menu interaction with media player:

1. Boot on source:
 - Input:
 - If you select Media player source, platform will go to media player automatically after the boot process is completed.
 - Playlist:
 - Main page: go to the main page of media player.
 - Playlist 1 - Playlist 7: go to media player and playback File1 - File7 of playlist automatically
 - Playlist 8: go to media player and play USB files automatically.
2. Schedule:
 - Schedule list:
 - Set up to 7 schedules.
 - Enable:
 - Enable/disable schedule.
 - Start time:
 - Set start time.
 - End time:
 - Set end time.
 - Playlist:
 - 1-7 : go to media player and playback File1 - File7 of playlist automatically.
 - Days of the week:
 - Set Sunday, Monday, Tuesday, Wednesday, Thursday, Friday, Saturday.
 - Every week:
 - Set a weekly schedule.
 - Save:
 - Save the schedule.

4.4.2. Media Player introduction:

1. Main page of Media Player, this page has three items: "Play", "Compose" and "Settings".
 Play : select playlist to play.
 Compose: edit playlist.
 Settings: set Media Player properties.

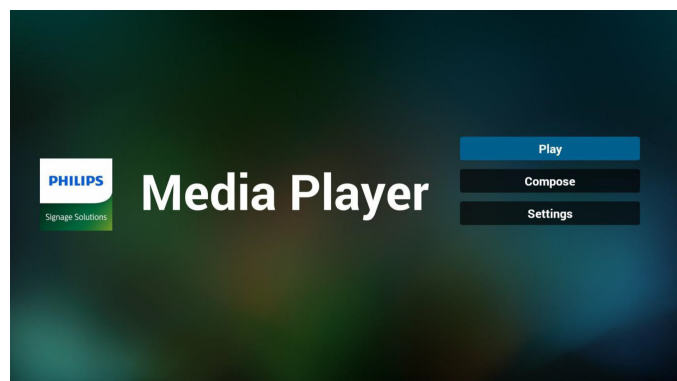

2. Select "Play" on the main page, first you should choose one playlist to play between FILE 1 and FILE 7. The pencil icon means the playlist is non-empty.

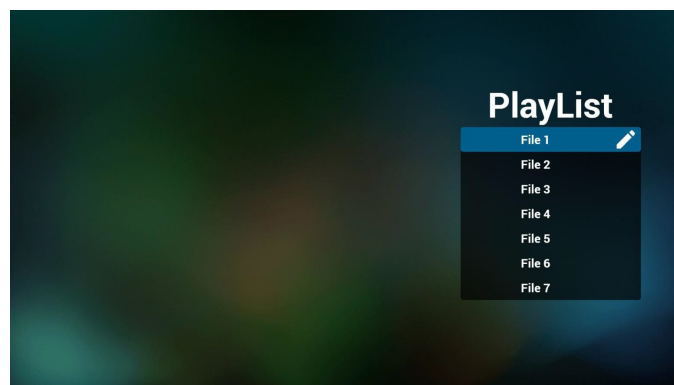

3. Select "Compose" on the main page, first you should choose one playlist to edit between FILE 1 and FILE 7. The pencil icon means the playlist is non-empty.

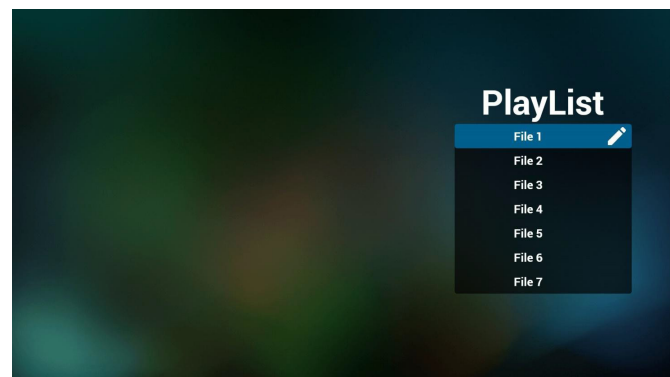

4. If an empty playlist is chosen, the App will guide you through selecting the media source.
 All media files should be placed in /philips/ of root directory.
 For example,
 videos: {root dir of storage}/philips/video/
 photos: {root dir of storage}/philips/photo/
 music : {root dir of storage}/philips/music/

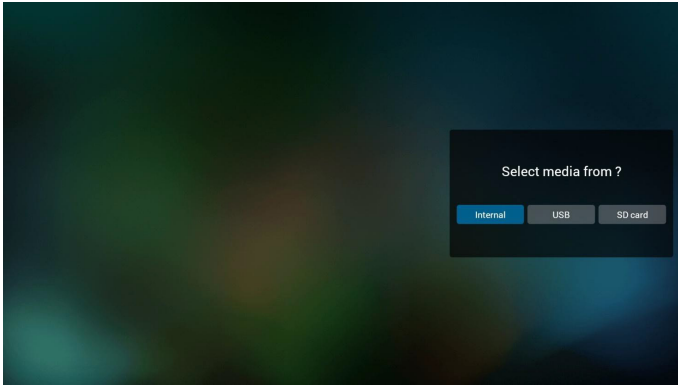

5. If you select “USB” storage, the App will guide you through selecting the USB device.

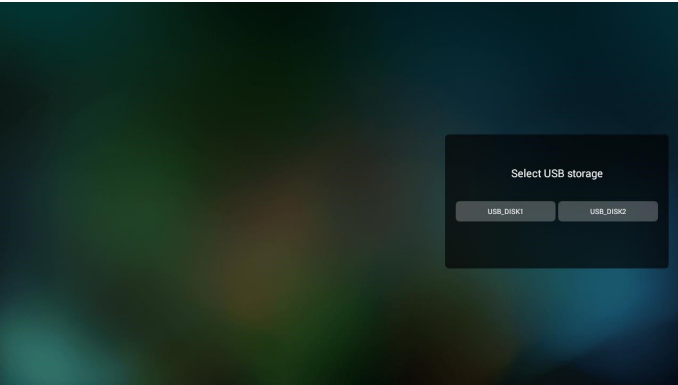

6. To edit or delete a non-empty playlist, select the desired playlist that has a pencil icon on right side of the selected file.

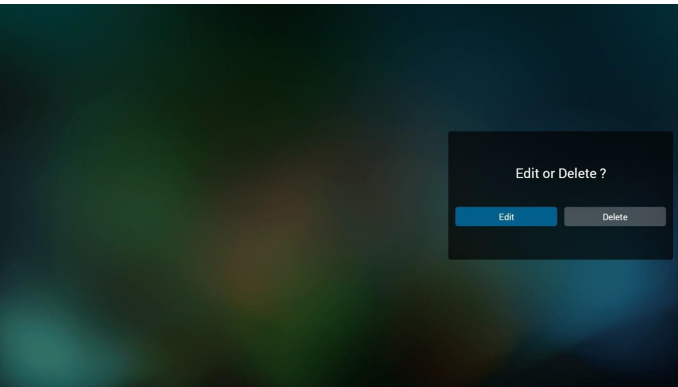

7. Once you start to edit a playlist, you will see below screen.

- Source - files in storage.
- Playlist - files in playlist.
- Option - launch the side menu bar.
- Play key - play the media file.
- Info key - show the media information.
- Touch file - select/deselect a file.

Note:
When long press on one of the directory in Source, full path will then be displayed.

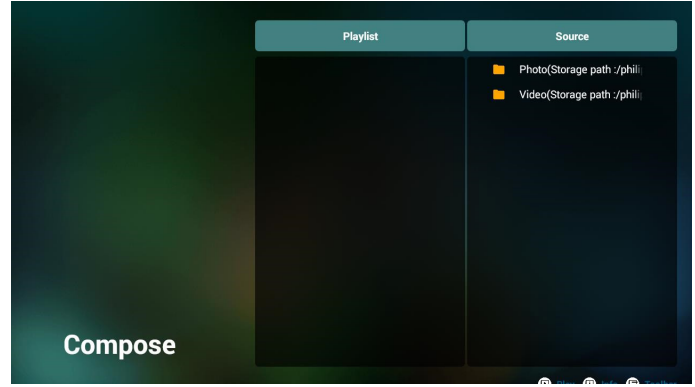

7-1 From the side menu bar, the following functions are available:

- select all: select all storage files.
- delete all: delete all playlist files.
- add/remove: update playlist from source.
- sort: sort playlist.
- save/abort: save or abort playlist.
- back: return to the previous menu.

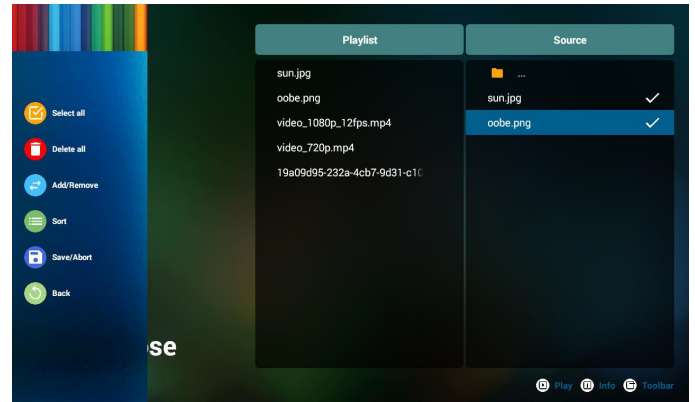

8. If “Sort” is selected, you can customize the file order severally.

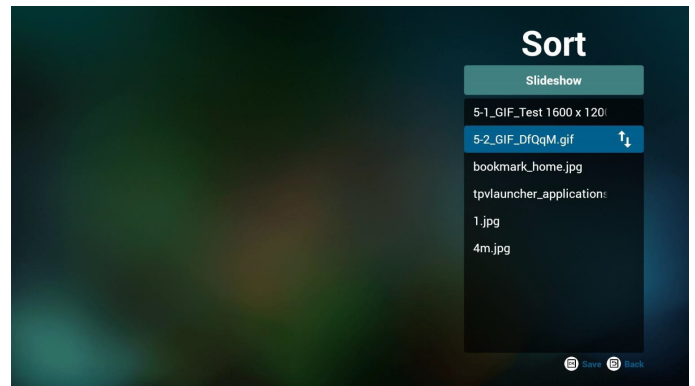

9. After selecting the desired file, press “Info” key to obtain the detailed information.



10. After selecting the desired file, press “Play” key to play the media file.



11. If you created a playlist with all image files, you will be asked to add a background music to the slideshow before saving.

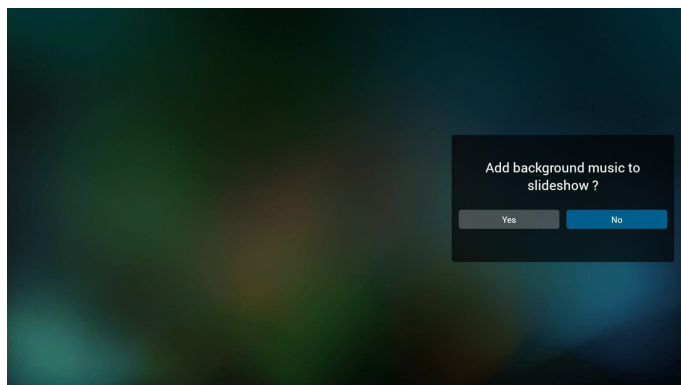

12. Select “Settings” on the main page, there are 5 options available: “Repeat Mode”, “Slideshow Effect”, “Effect Duration”, “Software Decode” and “Autoplay”.
- Repeat mode:** set the repeat mode.
Slideshow Effect: photo slideshow effect.
Effect Duration: duration of photo effect.
Software Decode: no black screen between video play.
Autoplay: Plug in the USB device and it will play the files from USB root path automatically. (4.4.3. Setup Media Player Autoplay)

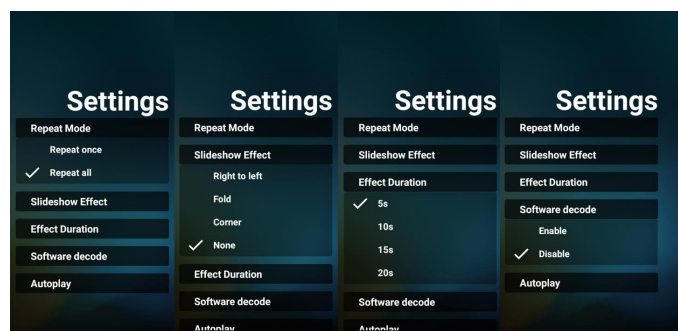

13. Media Hotkey
 Play: playback the file.
 Pause: pause playback.
 Fast forward: fast forward playback for 10 seconds.
 Rewind: rewind playback for 10 seconds.
 Stop: Stop playback and return to start. If the file being played is a gif file, then this feature acts as a pause key.

14. To learn how to change media format, please refer to Change Picture Format on P. 17.

15. How to edit playlist via FTP.

Step 1. Create media player text file.

- File name : mpplaylistX.txt, “X” means playlist number(1,2,3,4,5,6,7).

Ex. mpplaylist1.txt, mpplaylist2.txt

- Content :

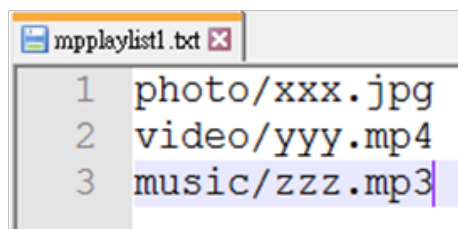

Note: If a playlist contains both video and music files, a black screen will appear when the system plays the music file.

Step 2. Copy “mpplaylistX.txt” to “philips” folder of internal storage. You may use FTP to do this.

- File path : /storage/emulated/legacy/philips
- Ex. /storage/emulated/legacy/philips/mpplaylist1.txt

Step 3. Prepare the media file in “Photo”, “Video” and “Music” folders which are under “Philips” folder of your internal storage.

- Ex. /storage/emulated/legacy/philips/photo/xxx.jpg
 /storage/emulated/legacy/philips/video/yyy.mp4
 /storage/emulated/legacy/philips/photo/zzz.mp3

Step 4. Start media player app, it will import the text file of media player automatically.

Note: Once the playlist file (text) is imported, any changes made by remote control will not be recorded in the playlist text file.

4.4.3. Setup Media Player Autoplay

1. Transfer media files (photos and videos) under root folder of USB or SD card external storage, do not transfer file to philips/ folder.
2. Go to MediaPlayer -> Settings -> Autoplay; check the checkbox to enable autoplay. User can also select auto play the photo files only, video files only, or both.
3. Return to the main page of MediaPlayer and insert the USB device or SD card.

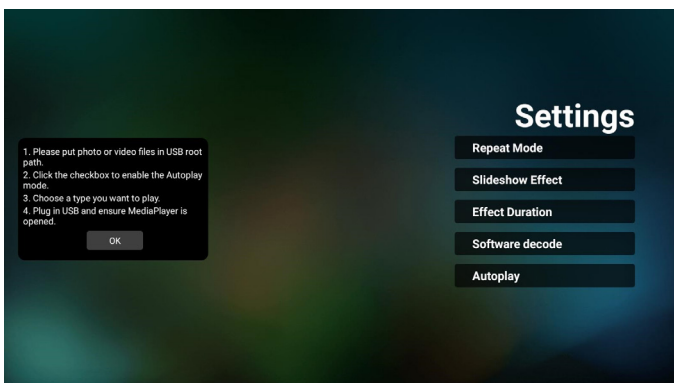
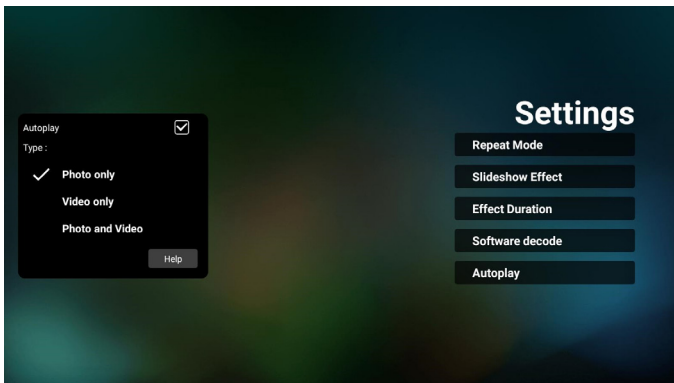
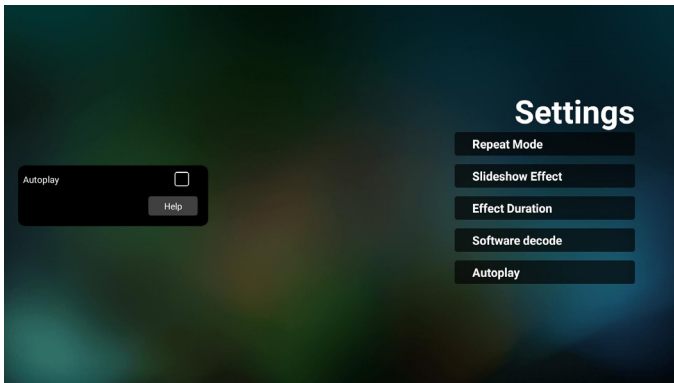

Notes:

1. Auto play media files in numeric order first, then in alphabetical order next.
2. If the USB device or SD card is unplugged during auto play process, MediaPlayer will stop running and return to main page.
3. Auto play has higher priority than playlist. If auto play is enabled while MediaPlayer is playing the file, then MediaPlayer will stop playing the list and start auto playing instead.

4.5. Browser

Before using this feature, ensure that the system is connected successfully to the network.

1. Main page of “Browser” App which allows you to make related settings.

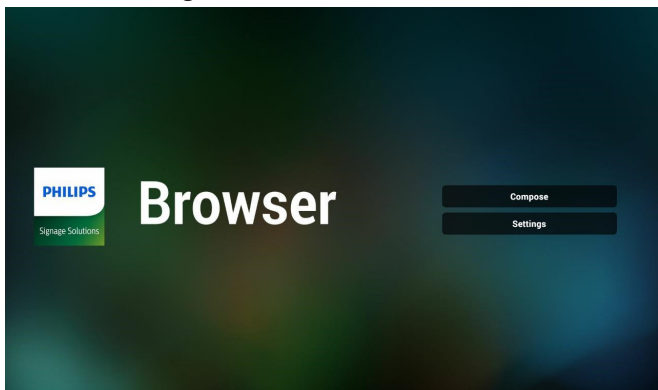

2. Press “Compose” then enter next page. Users can choose 1-7. Press any one will show a dialog.

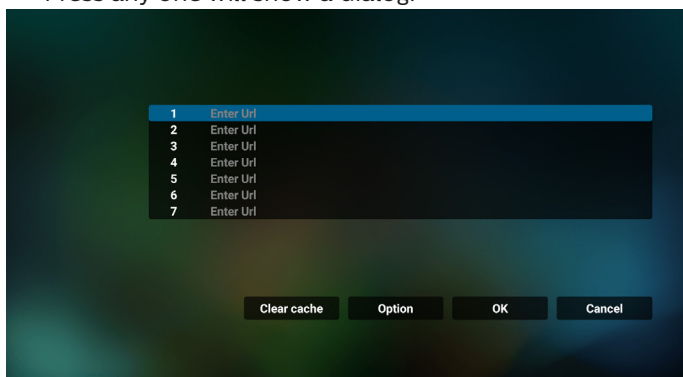

3. Use the on-screen keyboard to enter URL and press the OK button, the data will be saved in the List

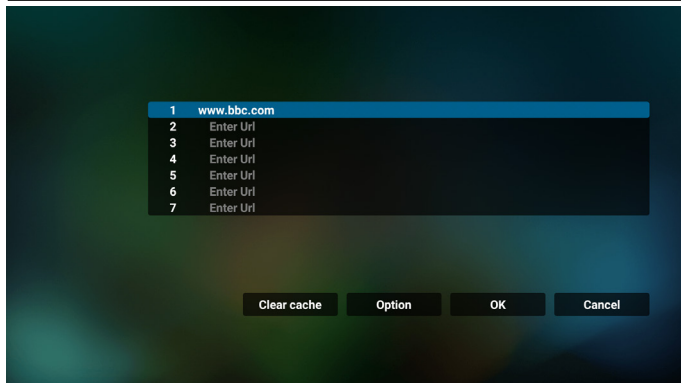
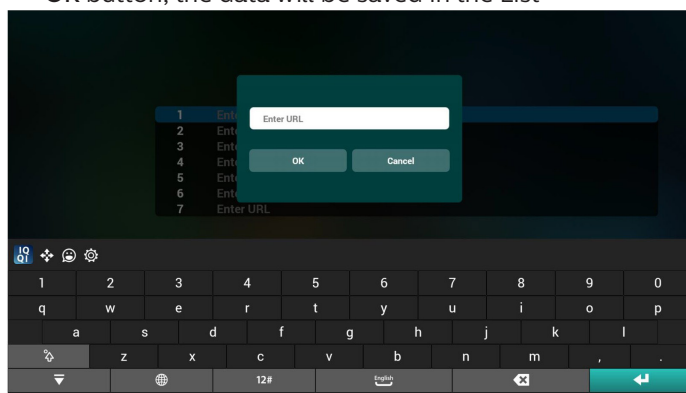

4. Press Option then a list will pop up on the left side.
 - Import:** Import the file of URL list
 - Export:** Export the file of URL list
 - Delete all:** Delete all URL records from the main screen
 - Back:** Close the side menu bar

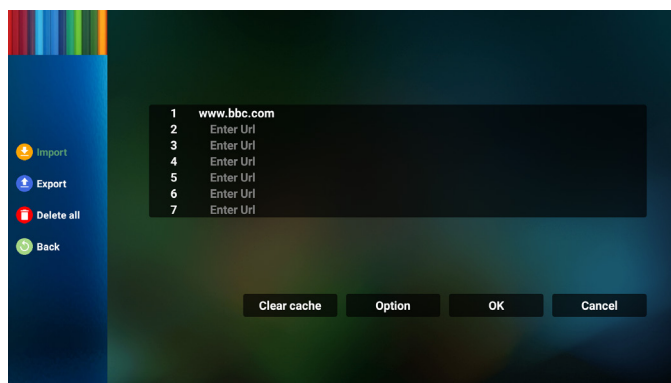

4.1 Import

- Select import.

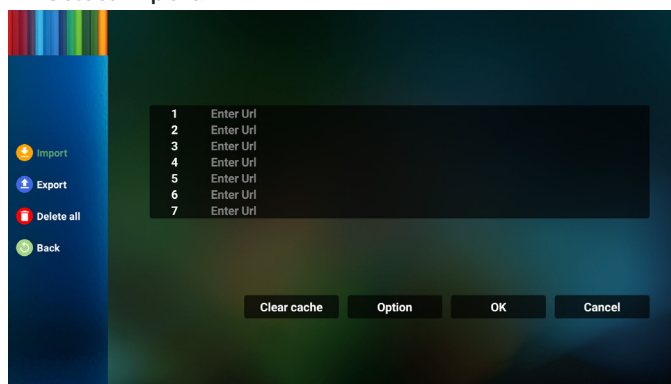

- Select the storage where the file will be imported from.

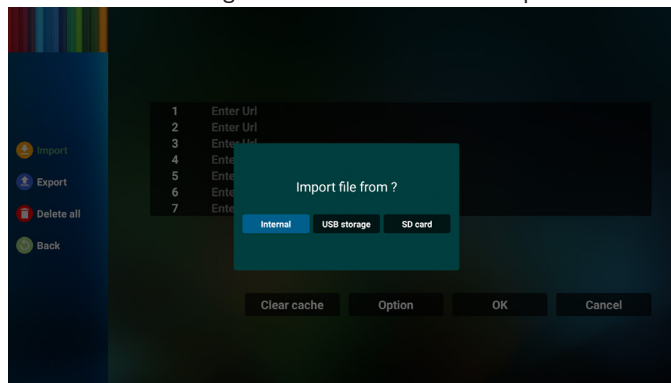

- Select a browser file

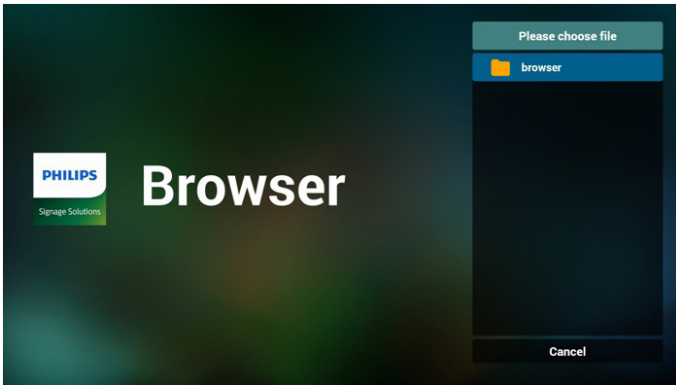

- Select the storage where the file will be exported to.

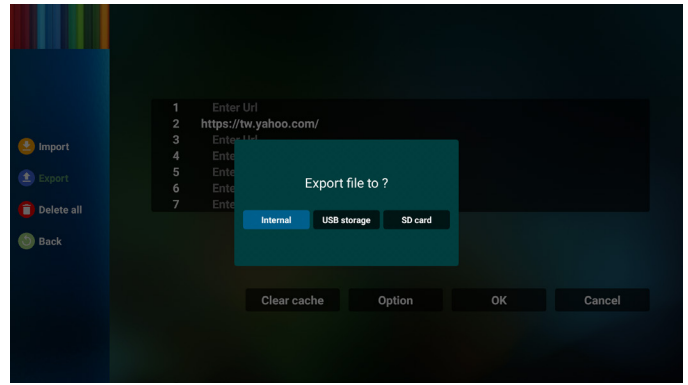

- Import the browser file and the URL will be listed on the screen.

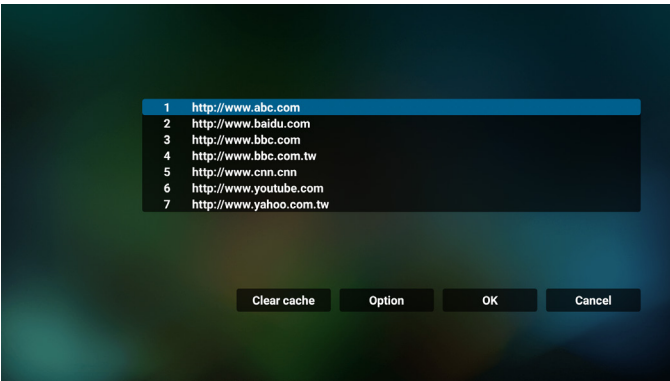

- A dialog box displays the path of the file to be saved as well as the file name. Press the "Save" button to save the URL.

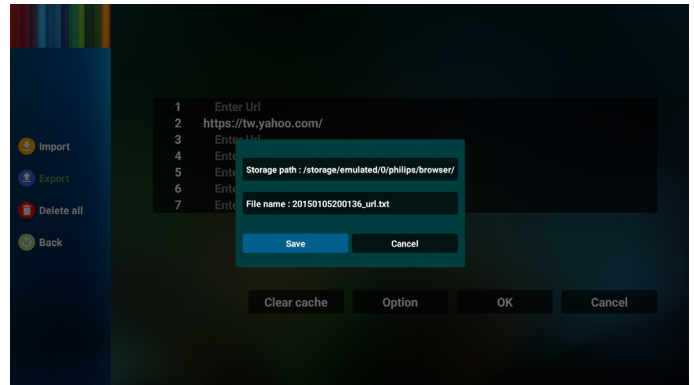

- The file format supported for import is ".txt".

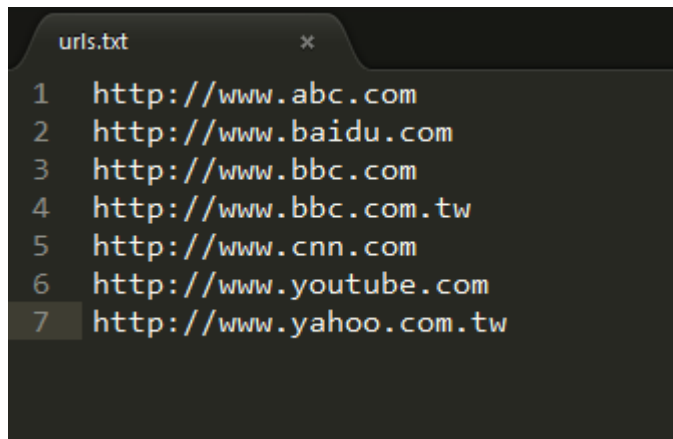

- 5. Press the "OK" button to save the URL record.

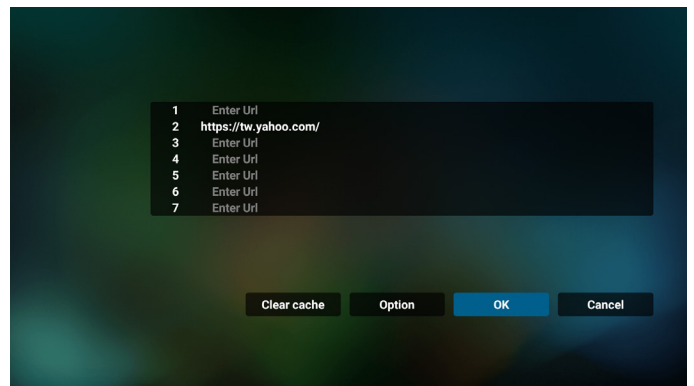

4.2 Export:

- Select export

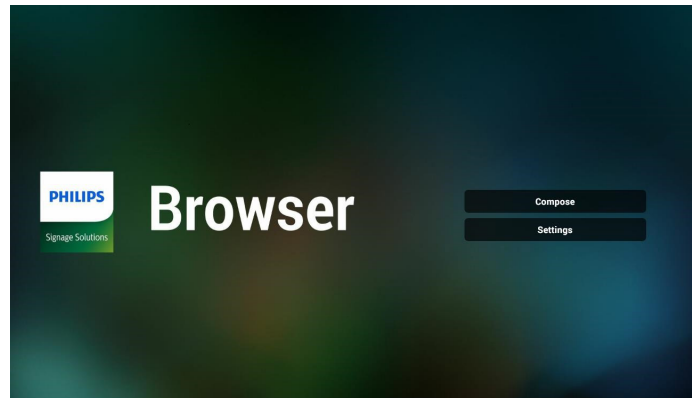
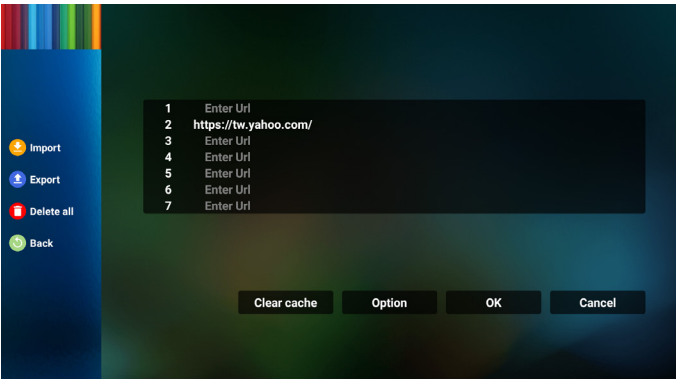

6. If you select a non-empty item from the URL list, a message will appear asking if you want to edit or play the URL. If you select “Edit” a dialog box allows you to edit the URL. If you select “Play”, a web page of the selected URL appears.

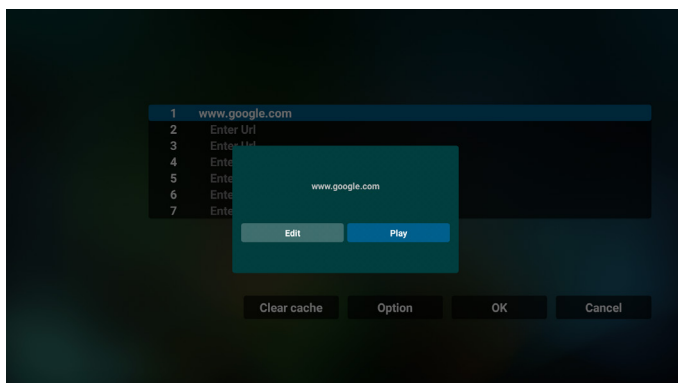
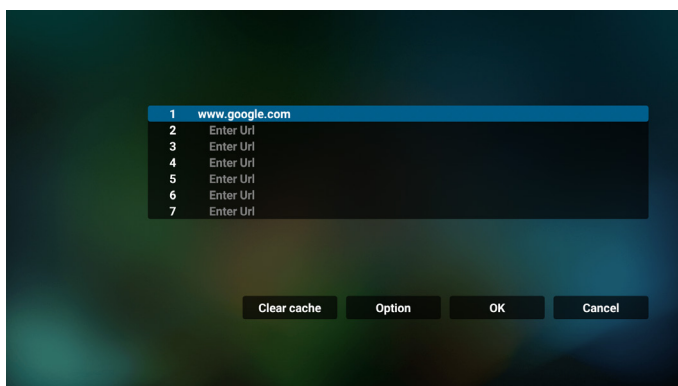

7. Press “Settings” then enter next page.

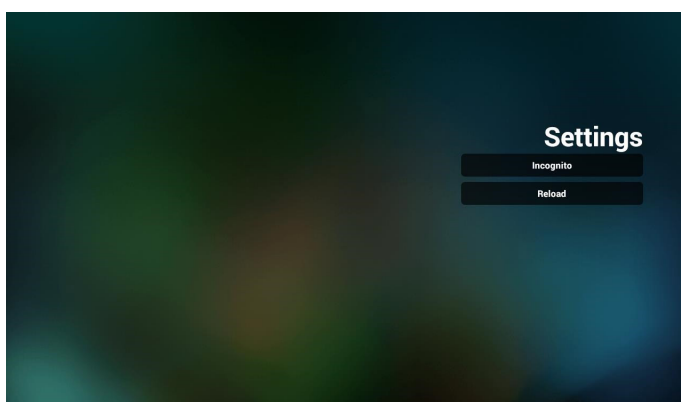
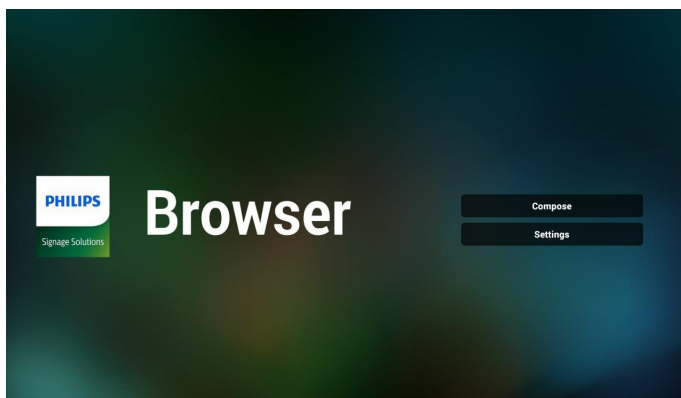

7.1 Incognito

- Enable: Display webpages using incognito mode.
- Disable: Display webpages using non-incognito mode.

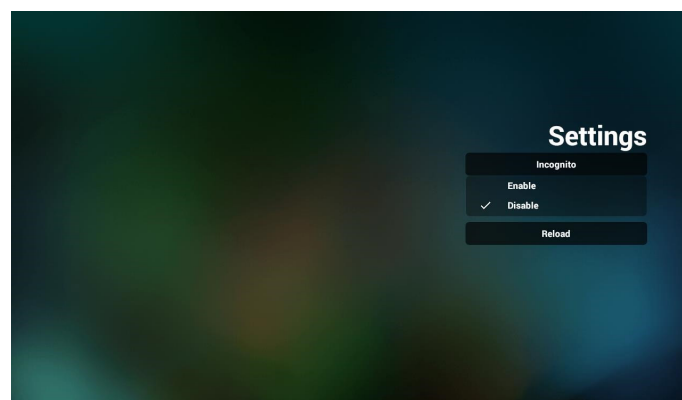

7.2 Reload

Allow user to set webpage reload time.

- If the “Enabled” checkbox is unchecked, the default reload time is 60 seconds.

Note:

In this case, the webpage only reloads when network state has changed.

If network state is always connected, the webpage won't reload after 60 seconds.

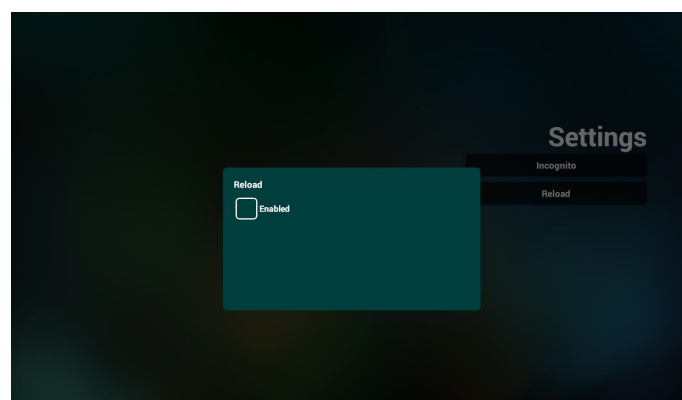

- If the “Enabled” checkbox is checked, you can set the reload time.

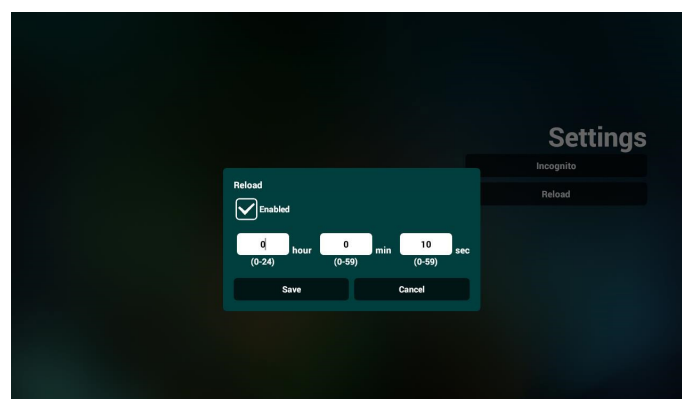

8. OSD menu interaction with Browser

8-1. Boot on source

- Set OSD menu > Configuration1 > Boot on source > set BROWSER Play List to 0.
Then PD will show Browser after rebooting.
- Set OSD menu > Configuration1 > Boot on source > set BROWSER Play List to 1.
Then PD will show web page with 1st Url in Browser app.

8-2. Schedule

Set OSD menu > Advanced option > Schedule > On time1, Off time2, set the BROWSER, day of the week, and Play List. Finally check the right box.
Then PD will show web page with Url in Browser app at time1 and finish at time2.

9. How to edit url list via FTP

Step 1. Create a text file of media player.

- File name: bookmarklist.txt.
- Content:



Step 2. Copy bookmarklist.txt to "philips" folder of your internal storage. You may use FTP to do this.

- File path: /storage/emulated/legacy/philips (for DL, PL)

Ex. /storage/emulated/legacy/philips/bookmarklist.txt

Step 3. Start Browser App, it will import the text file of Browser automatically.

Note. Once the playlist file (text) is imported, any changes made through the remote control will not be recorded in the playlist text file.

10. Offline browsing

When Url 1 has set address, and use osd schedule to open Url 1 web page, browser app will automatically save home web page data of Url1 to local storage.

If network is disconnected while osd schedule opens browser app, browser app will automatically open Url 1 address home page in local storage.

Note:

- Browser app can only save Url 1 address home page data, other Url 2 to Url 7 cannot be saved.
- Local storage : /sdcard/Download/OfflineBrowsing
- Pressing "Clear cache" button can clear Url 1 address home page data from local storage.

4.6. PDF Player

4.6.1. Settings menu interaction with PDF player:

1. Boot on source:
 - Input:
 - If you select PDF player source, platform will go to PDF player automatically after the boot process is completed.
 - Playlist:
 - Main page: go to the main page of PDF player.
 - Playlist 1 - Playlist 7: go to PDF player and playback File1 - File7 of playlist automatically
2. Schedule:
 - Schedule list:
 - Set up to 7 schedules.
 - Enable:
 - Enable/disable schedule.
 - Start time:
 - Set start time.
 - End time:
 - Set end time.
 - Playlist:
 - 1-7 : go to PDF player and playback File1 - File7 of playlist automatically.
 - Days of the week:
 - Set Sunday, Monday, Tuesday, Wednesday, Thursday, Friday, Saturday.
 - Every week:
 - Set a weekly schedule.

4.6.2. PDF Player introduction:

1. Main page of PDF Player, this page has three items: “Play”, “Compose” and “Settings”.
 Play: select playlist to play.
 Compose: edit playlist.
 Settings: set PDF Player properties.

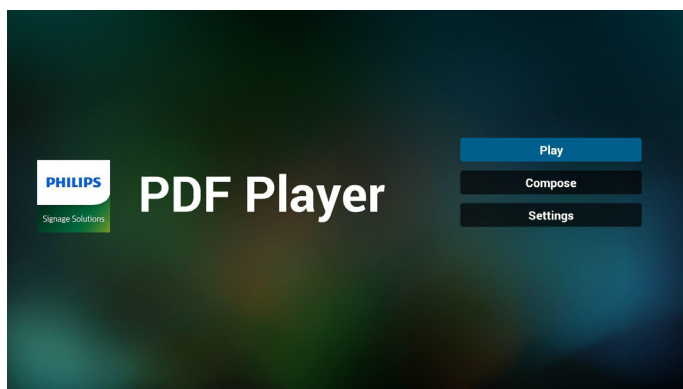

2. Select “Play” on the main page, first you should choose one playlist to play between FILE 1 and FILE 7.

The pencil icon means the playlist is non-empty.

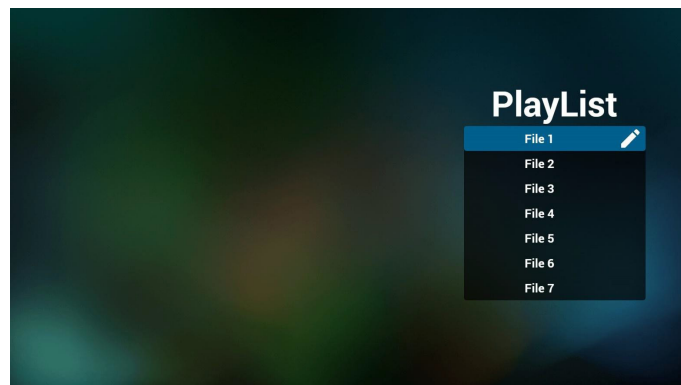

3. Select “Compose” on the main page, first you should choose one playlist to edit between File 1 and File 7. The pencil icon means the playlist is non-empty.

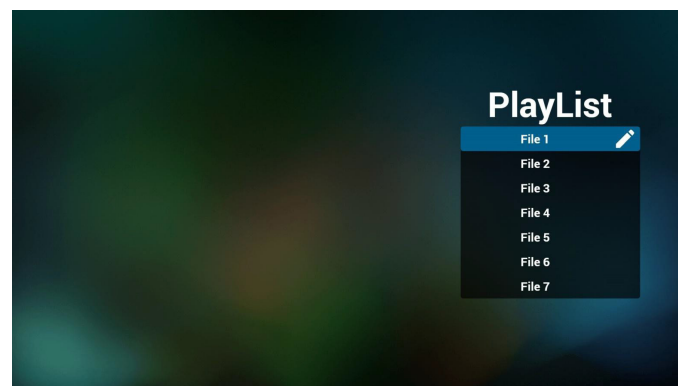

4. If an empty playlist is chosen, the App will guide you through selecting the media source.

All media files should be placed in /philips/ of root directory.

For example,

pdfs : {root dir of storage}/philips/pdf/

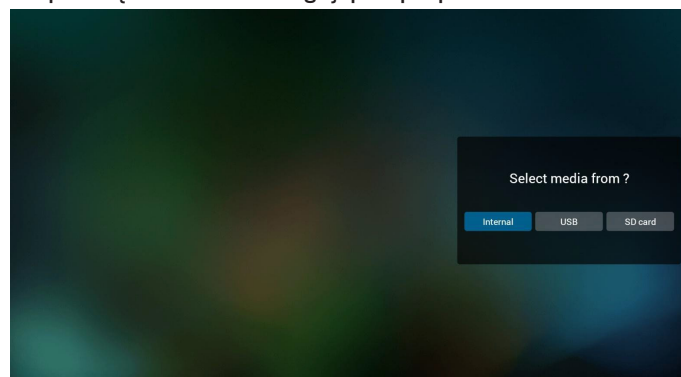

5. To edit or delete a non-empty playlist, select the desired playlist that has a pencil icon on right side of the selected file.

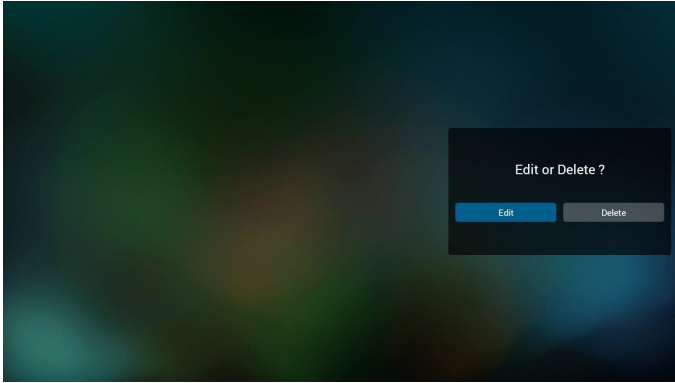

6. Once you start to edit a playlist, you will see below screen.

Source - files in storage.

Playlist - files in playlist.

The following functions can be operated through the corresponding keys on the remote control.

Option key - launch the side menu bar.

Play key - play media file.

Info key - show media info.

Ok key - select/unselect file.

6-1. From the side menu bar, the following functions are available:

- Select all: select all storage files.
- Delete all: delete all playlist files.
- Add/remove: update playlist from source.
- Sort: sort playlist.
- Save/abort: save or abort playlist.
- Back: return to the previous page.

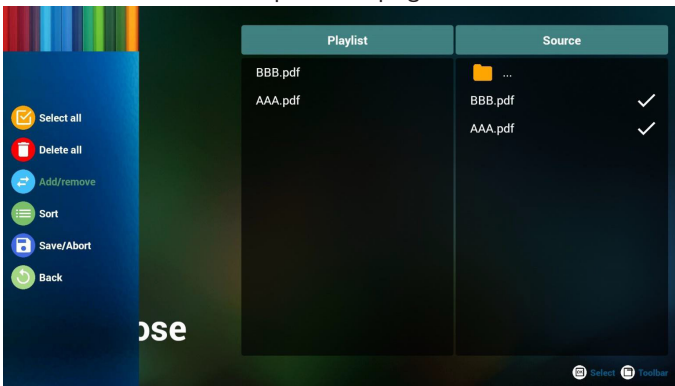

7. If "Sort" is selected, you can customize the file order severally.

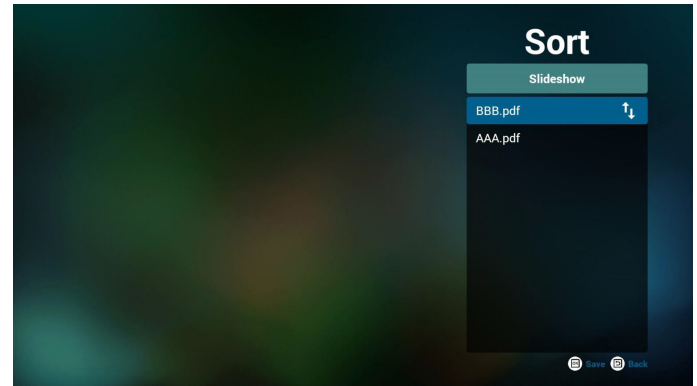

8. Select "Settings" on the main page, there are 2 options available: "Repeat Mode" and "Effect Duration".

Repeat Mode: set repeat mode.

Effect Duration: duration of photo effect.

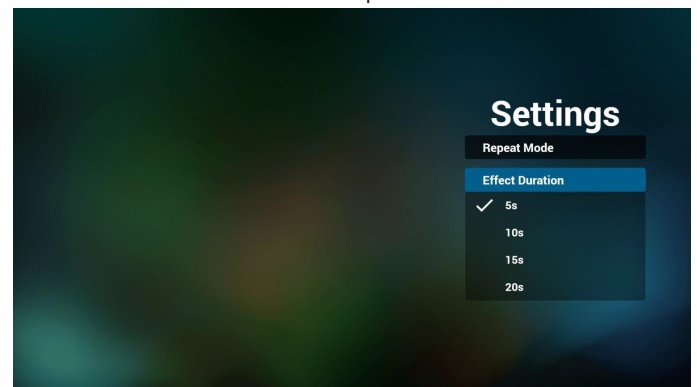

9. How to edit pdf list via FTP.

Step 1. Create pdf player text file.

- File name : pdfplaylistX.txt, "X" means playlist number(1,2,3,4,5,6,7).

Ex. pdfplaylist1.txt, pdfplaylist2.txt

- Content:

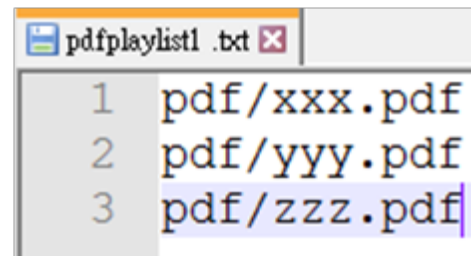

Step 2. Copy pdfplaylistX.txt to "philips" folder of internal storage. You may use FTP to do this.

- File path : /storage/emulated/legacy/philips (for DL, PL)
Ex. /storage/emulated/legacy/philips/pdfplaylist1.txt

Step 3. Prepare the PDF files in "PDF" folder which is under "Philips" folder of your internal storage.

- Ex. /storage/emulated/legacy/philips/pdf/xxx.pdf
/storage/emulated/legacy/philips/pdf/yyy.pdf
/storage/emulated/legacy/philips/pdf/zzz.pdf

Step 4. Start the PDF player App, it will import the text file of PDF player automatically.

Note: Once the playlist file (text) is imported, any changes made through the remote control will not be recorded in the playlist text file.

Media Hotkey:

Play: Playback file.

Pause: Pause playback.

Fast forward: go to the next page. If the page is at end of the file, it will go to the next file.

Rewind: back to the last page. If the page is at beginning of the file, it will go back to the last file.

Stop: Return to the first page of file.

Arrow keys:

Left: go to the previous page.

Right: go to the next page.

Combination key:

Number key + OK key: change to a specific page.

- Press number key to select a specific page.
- Press "OK" key. Page number will display at the bottom of the page. If the page number you selected exceeds total page number, then that page will not be changed, but display current page number instead.

Note:

If you plug in two or more USB disks to edit the playlist, playback from the playlist cannot be guaranteed after powering on/off, due to the USB storage path may be changed. It is strongly recommended to use only one USB disk when editing the playlist.

4.7. CMND & Play

1) Server

Setup CMND & Play server address

2) Account

Setup CMND & Play account

3) PIN Code

Setup CMND & Play PIN code

(4) Version

There are two options, Ver.2 and Ver.3

Ver. 2

use 2.0/2.2 agreement

Ver. 3

use 3.0/3.1 agreement

(5) Content

There are 3 options available: internal storage, SD card and USB storage.

If Ver.2 is selected, Server/Account/PIN code will be grayed out and unavailable.

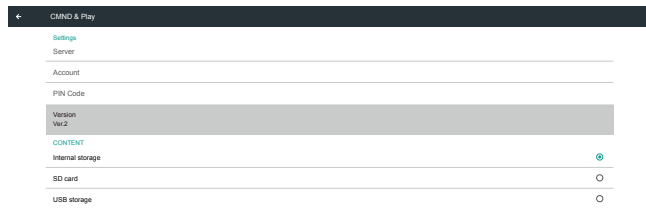

If Ver.3 is selected, Server/Account/PIN code is available.



4.8. Custom App

User can set up the application for Customer Source

Note:

(1) Only the App installed by user will be displayed.

(2) The pre-installed App will not be displayed.

4.8.1. OSD Menu operation:

RCU: Source -> Custom

If you set up customer APK, the customer App will be launched when switching source to customer mode.

If customer APK is not set, the system shows a black screen when switching source to customer mode.



4.8.2. Function Introduction

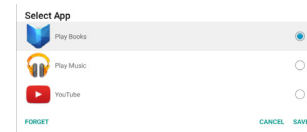

Save

Select the App, click the “Save” button will perform the function of storage.

Forget

Press “Forget” button to remove previously stored information.

Cancel

Press “Cancel” button to quit without saving changes made. If no customer APK is installed, the list will be blank, and the “Save” and “Forget” buttons will be grayed out.



If customer APK is installed, user can select it from the list.

- Case 1: Not setting Custom App.
Custom App will display and the focus is on the first item automatically.

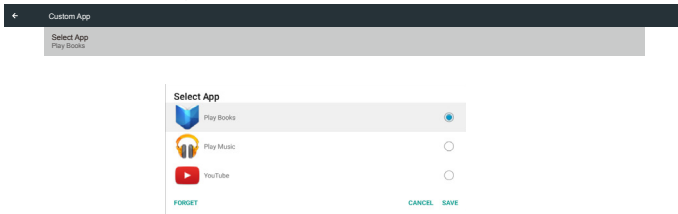

After setup, the screen shows App's name.



- Case 2: Setting the Custom App (an entity circle on the right of the icon)

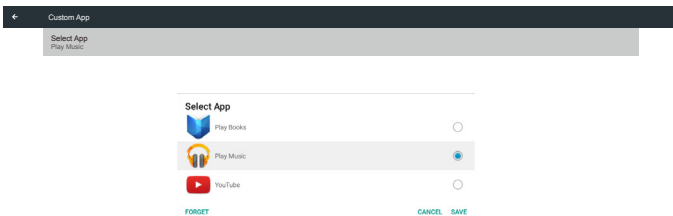

5. Setting UI

5.1. Settings

Enter PD settings by clicking “Settings” icon in Admin mode.

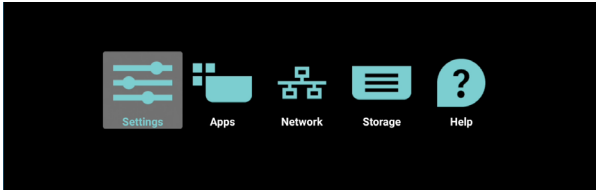

Setting menu consists of the following items:

- (1). Network & Internet
- (2). Signage Display
- (3). Apps & notifications
- (4). Display
- (5). Security
- (6). System

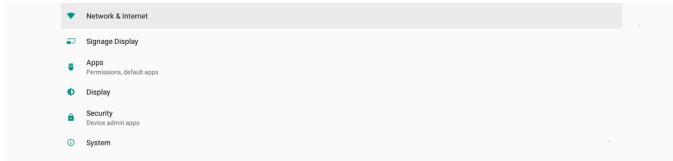

5.1.1. Network & Internet

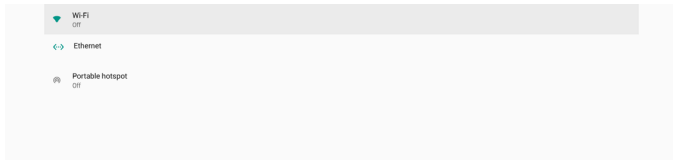

5.1.1.1. Wi-Fi

Settings -> Network & Internet -> Wi-Fi

Enable Wi-Fi

Enable/disable Wi-Fi connection through main switch in Setting -> Network & Internet -> Wi-Fi -> Off/On toggle button.

Wi-Fi Off

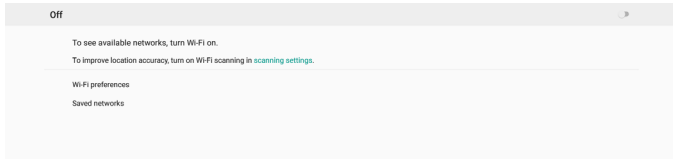

Wi-Fi On

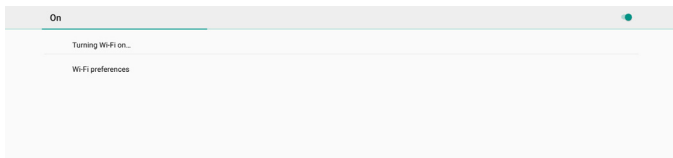

On the available network list, select an AP (access point) on an existing wireless network.

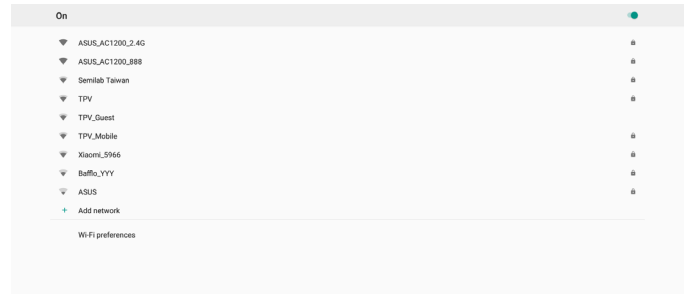

Enter the required settings.

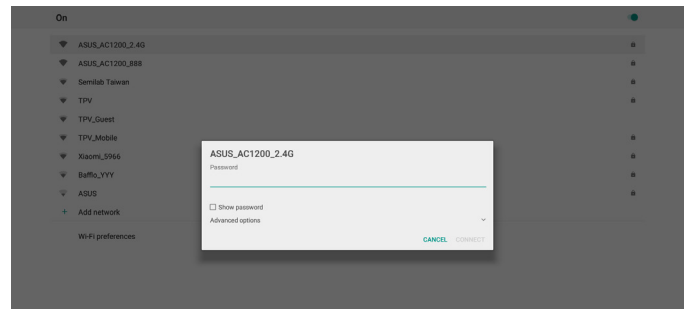

At the bottom of the list, select “Add network” to add a network not shown on your list.

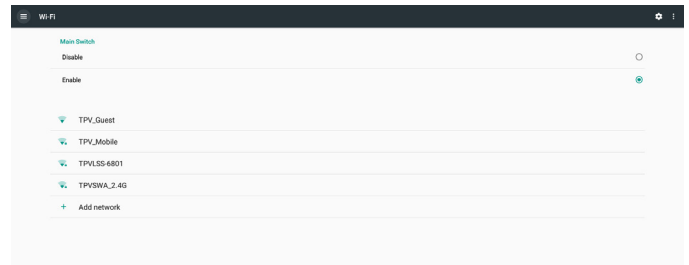

If needed, enter the network name (SSID) and security details.

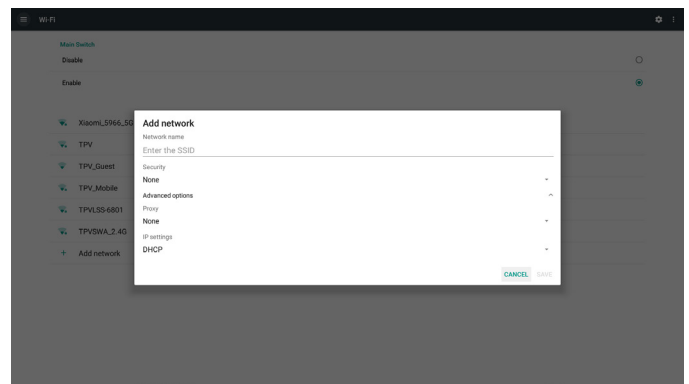

Note:

When Wi-Fi is enabled, Ethernet will be disabled automatically.

Wi-Fi Preference

Settings -> Network & Internet -> Wi-Fi -> Wi-Fi Preference

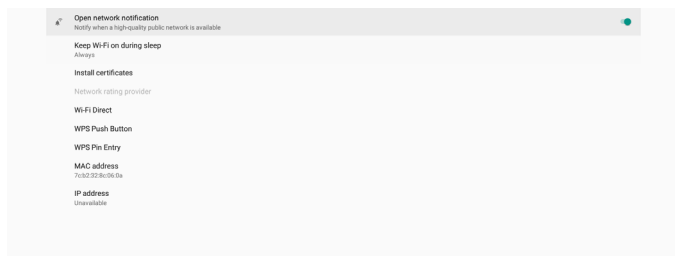

Using WPS

WPS network can be enabled using 2 options:

PBC (Push Button Configuration), in which the user simply has to push a button to connect.

PIN (Personal Identification Number), in which a PIN will be entered in client WPS device to connect.

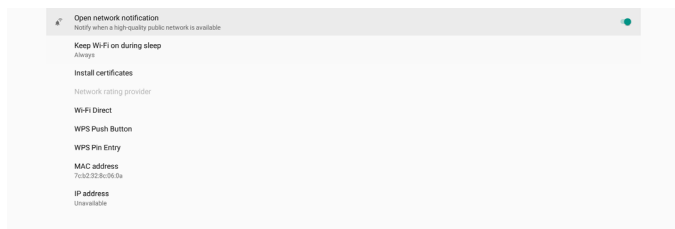

When using PBC method, select “WPS Push Button” to connect.

When using PIN method, select “WPS Pin Entry” and enter the PIN to connect.

Wi-Fi Network Information

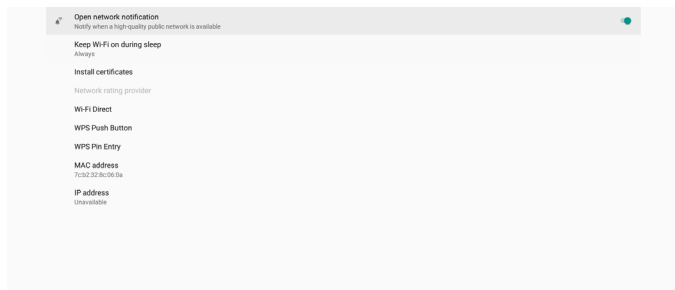

MAC address: shows Wi-Fi MAC address.

IP address: shows the IP address when the device joins a network.

5.1.1.2. Ethernet

Settings -> Network & Internet -> Ethernet

Enable Ethernet

Enable/disable Ethernet connection by Setting -> Network & Internet -> Ethernet toggle button.

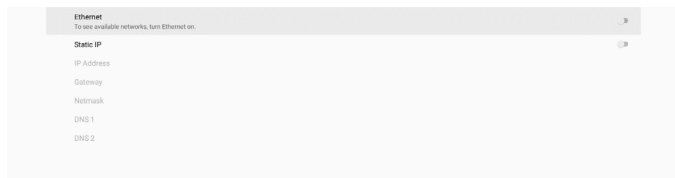

By default, the system uses DHCP to join the network.

Connection Information (When the options are grayed out, they are not editable).

- (1). IP Address
- (2). Gateway
- (3). Netmask
- (4). DNS 1/2 IP Address

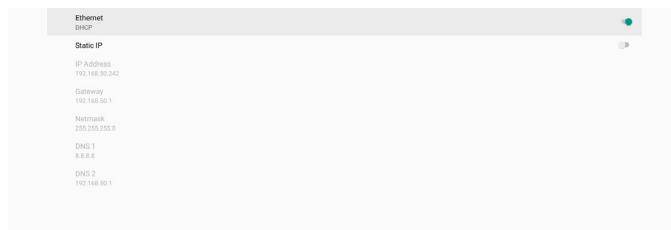

Note:

Wi-Fi connection will be disabled automatically when Ethernet connection is enabled.

Ethernet Static IP

User can manually set Ethernet IP address, Netmask, DNS address and gateway IP address when toggle “Static IP”.

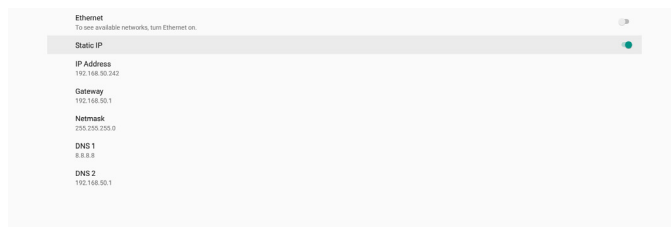

Then toggle Ethernet button again.

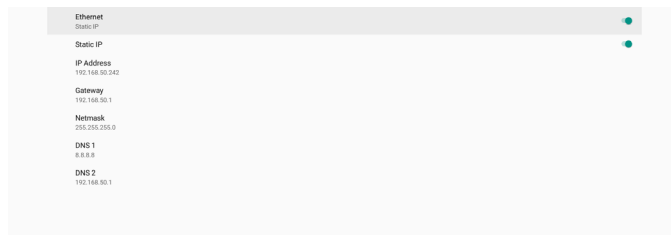

Note:

1. Please input IPv4 address in all fields; in dot-decimal notation, consisting of four decimal numbers, each ranges from 0 to 255, separated by dot.
2. User must input all fields for static IP connection before enabling Ethernet again.

5.1.2. Signage Display

Settings -> Signage Display, to setup most features of signage display. See below for more detailed information about Signage Display settings.



5.1.2.1. General Settings

Settings -> Signage Display -> General Settings

Set up Signage Display name, User logo and Screenshot.

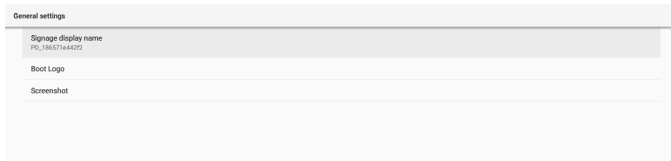

Signage Display Name

Settings -> Signage Display -> General Settings -> Signage Display Name

Set up Signage Display name, the default name is Ethernet MAC address with prefix "PD_". For example, "PD_000b12223398". The maximum length of name is 36 characters in UTF8 format. Click to rename it.

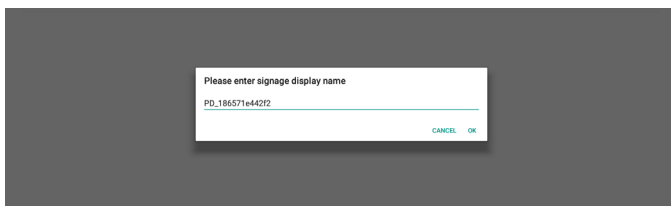

Boot Logo

Settings -> Signage Display -> General Settings -> Boot Logo

User can set up device boot up logo (boot animation) when OSD Menu -> Configuration 2 -> Logo is set to "User" mode.

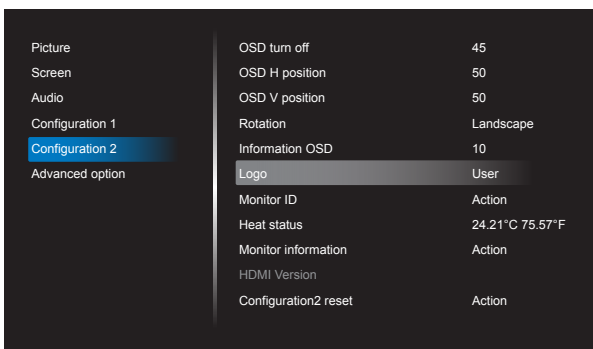

If "Logo" is not set to "User" mode, user cannot select custom boot animation.

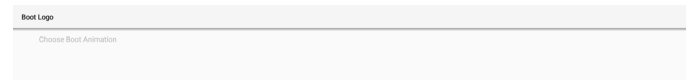

When it is set to "User" mode, the option "Choose Boot Animation" becomes available.

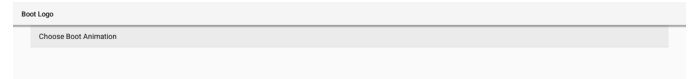

When Logo is set to "User" mode, the default Philips logo will be replaced by user selected boot animation file.

Click "Choose Boot Animation" and a pop-up menu appears for user to select boot animation file. Content saved on a SD card or USB memory card will be scanned automatically.

Boot animation file name must be set as "bootanimation.zip", any other format is invalid.

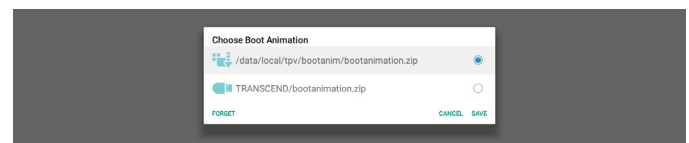

All available boot animation files can be found in the following folder:

1. File under /data/local/bootanimation/:
The boot animation file that are copied from USB or SD card.
2. File under {SD_STORAGE_VOLUME_NAME}/:
The boot animation file saved on the SD card.
3. File under {USB_STORAGE_VOLUME_NAME}/:
The boot animation file saved on the USB storage.

Dialog options:

1. FORGET
Clear "bootanimation.zip under /data/local/bootanimation/. Custom boot animation will not be used during system boot up.
2. CANCEL
Cancel and close the dialog box.
3. SAVE
Copy selected file to /data/local/bootanimation/. After doing this, user can remove their external storage (USB and SD). System uses the boot animation file under /data/local/bootanimation.

If system does not found any bootanimation.zip file under external storage (USB, SD) and /data, the file list is empty. The “SAVE” and “FORGET” buttons are grayed out, user should check content saved on the USB memory or SD card. Click “CANCEL” button to close the dialog box, and plug in the USB memory or SD card again.

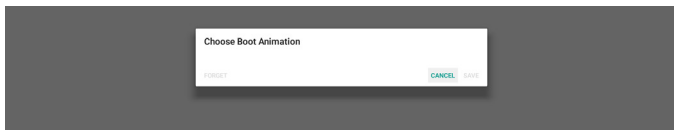

If /data/local/bootanimation/ folder is empty, it means that “bootanimation.zip” has not been saved before by user. Default Philips logo appears during system boot up.

When “bootanimation.zip” is found under external storage, a dialog box of the file list will appear.

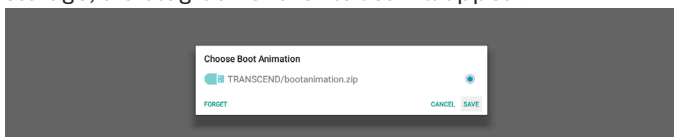

If the file “bootanimation.zip “ can be found in the folder “/data/local/bootanimation/”, the pop-up dialog box will show that file as the first option. It simply means that user has previously copied (saved) the file “bootanimation.zip” and that the system will boot up with boot animation from /data/local/bootanimation/bootanimation.zip.

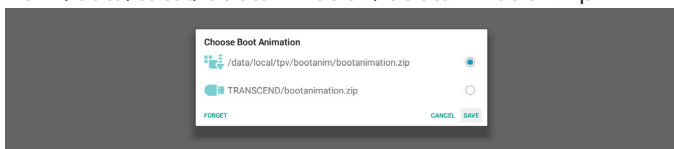

Boot animation file can be replaced by using the “SAVE” button.

Screenshot

Settings -> Signage Display -> General Settings -> Screenshot

To capture the screenshots from the imported content, click “Enable” to enable the auto screenshot function. If the screenshot options are shown in gray, it means that the screenshot function is not enabled yet.

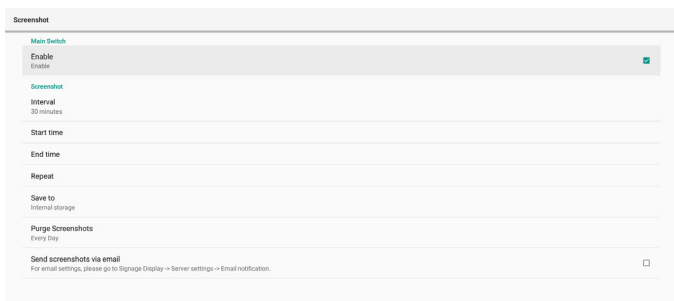

After enabling this feature, you can set the interval time between each screenshot, as well as the destination folder where the captured screen will be saved. The option “Save to” notifies you that the screenshot images will be saved in the internal storage and they cannot be changed manually.

NOTE:

- The screenshot images will be deleted automatically under the following conditions:
 - (1). When the start time of screenshot feature is set to 0

second.

- (2). Starting the screenshot at 40 seconds of minute.
- (3). If you decide to purge the screenshot photos every week, the data of deleting the photos will be changed to the day that you apply the setting of screenshot feature. For example, if you set the purging day to Monday of every week, then changed other settings in screenshot feature on Friday, the purging day will be changed to Friday (the day of system’s current time).

2. Sleep (system suspend) and screenshot feature: The screenshot feature is suspended when the system enters sleep mode. The function of mailing out the screenshot is consequently suspended. The screenshot-related features will be restarted when the system enters active mode.

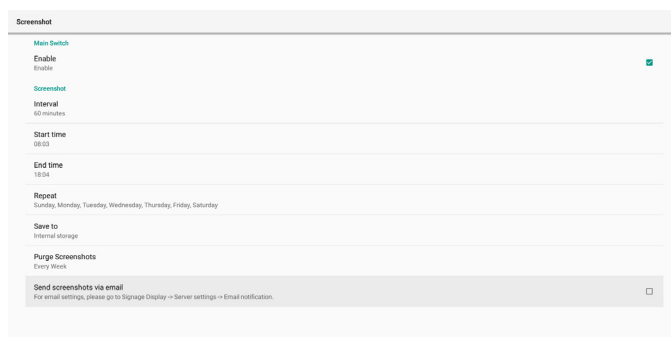

- (1). Interval
Set the interval time between each screenshot. The available options are 30 and 60 minutes.



- (2). Start Time
Set the start time of a day to begin the screenshot function. Make sure that you click the “Save” button before leaving the dialog box, or your settings will not be saved. The start time must be set at an earlier time than the end time. A toast message will appear notifying you if it is an invalid value.

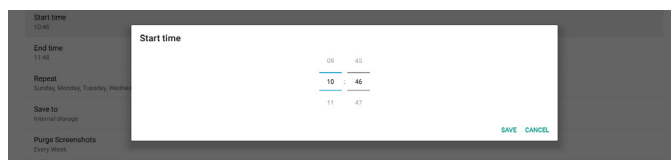

- (3). End Time
Set the end time of a day to end the screenshot function. Make sure that you click the “Save” button before leaving the dialog box, or your settings will not be saved. The start time must be set at an earlier time than the end time. A toast message will appear notifying you if it is an invalid value.



(4).Repeat

Set the repeat mode for auto screenshot.

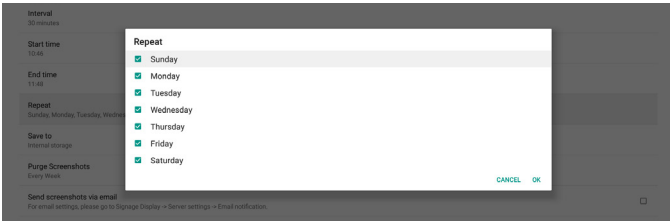

(5).Save to

The screen images will be saved under the folder named “philips/screenshot” of the internal storage.

(6).Purge Screenshots

Set the interval time for deleting the screenshot images. The available options are “Every day” and “Every week”.



(7).Send screenshots via email

You can send every screenshot image as an e-mail attachment. User must set up mail information first in “Settings -> Signage Display -> Server Settings -> Email notification” (Refer to [Email Notification](#) section).

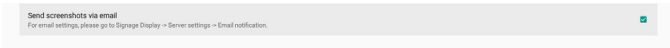

5.1.2.2. Server Settings

Settings -> Signage Display -> Server Settings

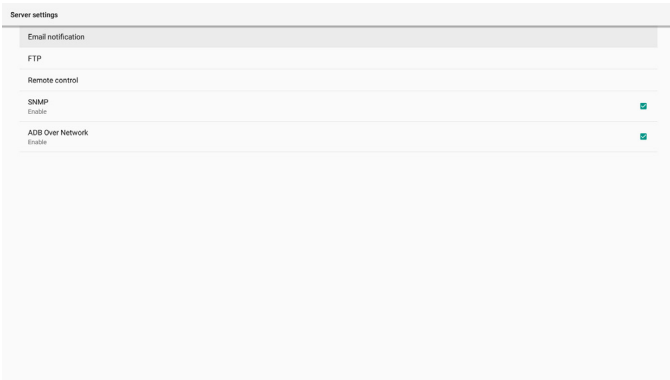

Email Notification

Settings -> Signage Display -> Server Settings -> Email Notification

Click checkbox to enable/disable E-mail notification feature. Set SMTP and manager E-mail after enabling the E-mail notification feature.



SMTP

Setup sender E-mail address and SMTP server information. There are two types of SMTP server for user to set up: “Gmail” and “Other”. By using “Other” option, user can manually setup STMP server, security type and server port.

Note:

1. The password should be in UTF8 format with 6 to 20 characters.
2. User cannot set port 5000 (SICP default port) and 2121 (FTP server default port).
SICP network port setting in “Settings -> Signage Display -> Network Application -> SICP network port”.
FTP network port settings in “Settings -> Signage Display -> Server settings -> FTP -> Port”.

Gmail: (SMTP server, Security type and Port are grayed out)

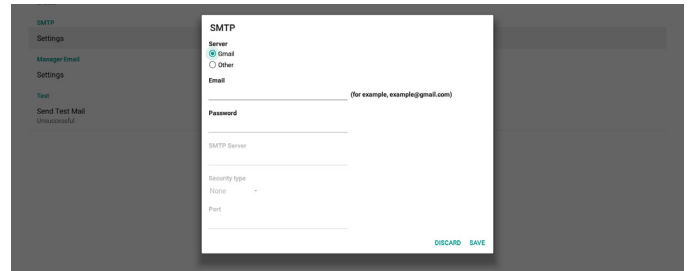

Other:

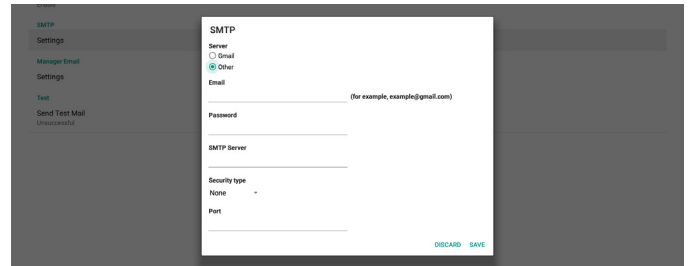

Gmail Security Settings

If a problem occurs when sending the e-mail via Gmail, please visit Google website “<https://www.google.com/settings/security/lesssecureapps>” for checking the security setting of your Google Account. Then turn on “Access for less secure apps”.

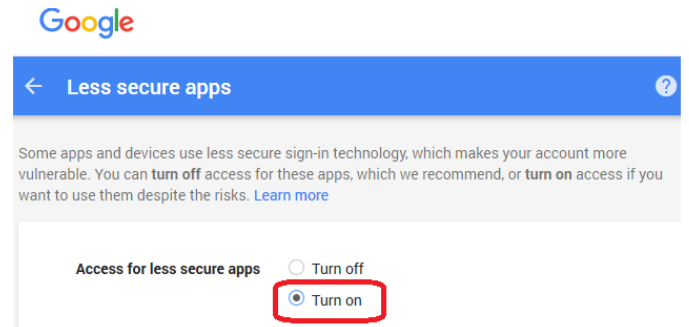

Manager Email

Specify the destination address to receive the e-mail.

Test

To check if your e-mail settings are correct or not, select ‘Send Test Mail’ to send a test e-mail.

FTP

Settings -> Signage Display -> Server Settings -> FTP

Click the checkbox to enable/disable FTP server feature. After enabling this feature, user can setup account, password and port number.

- (1). Account: The user name to log in the FTP server. The length of the account name should be ranged from 4 to 20 characters, only [a-z], [A-Z] and [0-9] are allowed to use.
- (2). Password: The password to log in the FTP server. The length of the password should be ranged from 6 to 20 characters, only [a-z], [A-Z] and [0-9] are allowed to use. The password are covered by asterisks after setting.
- (3). Storage path: The FTP server has access to the internal storage only. The storage path is unchangeable.
- (4). Port: The port number for FTP server. Available port number ranges from 1025 to 65535, the default setting is 2121. The following port number cannot be used: 8000 / 9988 / 15220 / 28123 / 28124 and SSCP network port (default 5000).

Finally, manually reboot the system to apply FTP settings.

Remote Control

Settings -> Signage Display -> Server Settings -> Remote Control

Click the checkbox ‘Enable’ to enable or disable the remote control client service. The default setting is ‘Enabled’. To use the remote control feature, the device must be bound with the remote control server.

In the entry field of ‘Server’, input the URL address with the prefix of ‘https://’. If the device is not bound with the remote control server, please enter the PIN code provided by the server.

Bind status:

- (1). If the device does not have appropriate network connection, a message ‘Network is disconnected’ will appear.
- (2). If the device is equipped with network function, but is not connected to the remote control server, a message ‘Server is disconnected’ will appear.
- (3). If a server is connected, but not bound, a message ‘Server is unbound’ will appear.
- (4). If the device is bound with the server successfully, a message ‘Server is bound’ will appear.
- (5). If the PIN code is not correct, a message ‘Error PIN code’ will appear.

SNMP

Enable/Disable SNMP service.

Please refer to the SNMP user manual.

ADB over Network

You can access ADB over a network connection with port 5555.

5.1.2.3. Source Settings

Settings -> Signage Display -> Source Settings

User can configure source APK’s detailed options.

Media Player

Settings -> Signage Display -> Source Settings -> Media Player

Open Media Player APK’s edit play list activity and edit effect settings activity.

Browser

Settings -> Signage Display -> Source Settings -> Browser

Open Browser APK’s bookmark editor activity.

CMND & Play

Settings -> Signage Display -> Source Settings -> CMND & Play

CMND & Play APK settings activity



- (1). Server
Set up CMND & Play Server IP address. Not available in 2.0 protocol.
- (2).Account
Set up CMND & Play Server account, account format should be [a-z] [A-Z] [0-9]. Not available in 2.0 protocol.
- (3).PIN Code
Set up CMND & Play PIN code. Not available in 2.0 protocol.
- (4).Version
Set up CMND & Play server protocol version.
 - (1). 2.0: Used for protocol version 2.0/2.2 (default)
 - (2). 3.0: Used for protocol version 3.0/3.1 (default when user selects JP language in OOB)
- (5).Content
CMND & Play APK supports playback content from internal storage (select “Internal Storage”) and external storage (select “SD card” or “USB storage”). CMND & Play APK will search content from the selected storage. The default setting is internal storage.

Please note that external storage cannot be removed (plug-out) when CMND & Play is playing content. In addition, the free disk space of the external storage must be double of the CMS file size for extracting CMS content.

PDF Player

Settings -> Signage Display -> Source Settings -> PDF Player
Open PDF Player APK’s edit play list activity and edit effect settings activity.



Custom app

Settings -> Signage Display -> Source settings -> Custom app

User can set up customer source APK. The selected APK will be launched when switching into customer input source. If customer source APK is not set, the system shows a black screen when switching to customer input source.

Default is “CMND&Deploy” APK.

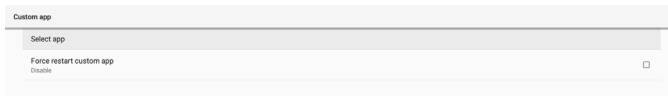

If a custom source APK is set, the APK name will be displayed. Otherwise, it means that the custom App has not been set.

Select APP

Select a specific APP for custom APP source.



Note:

The APKs pre-installed by the system will not be shown on the list. Only the APKs that were installed manually will be listed.

- (1). FORGET button
Clear the custom source application. It will be shown in gray if the customer source application has not been set.
- (2).CANCEL button
Quit without saving changes.
- (3).SAVE button
Click the “Save” button to select the APS as the custom source application. It will be shown in gray if no available application can be selected.

Force Restart Custom APP

When this feature is enabled, the system can monitor the status of custom APP. If the custom APP doesn’t exist and that boot on source is set to “Custom app”, the system will then try to launch custom APP again.

Default setting is Disable.

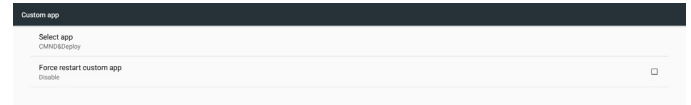

5.1.2.4.Network Application

Settings -> Signage Display -> Network Application

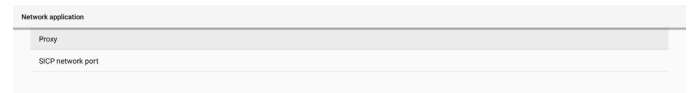

Proxy

Settings -> Signage Display -> Network Application -> Proxy
Enable the proxy server by clicking the checkbox of “Enable”. User can set up the host IP and port number of the proxy server. The default setting is “Disable”.

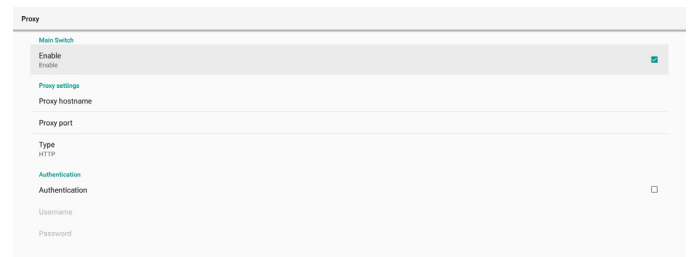

System supports the following proxy types: HTTP, HTTPS, SOCKS4, and SOCKS5. Choose one for your proxy server.



If an authorization is requested by proxy server, click the checkbox of “Authorization” and enter the username and password.



SICP Network Port

Settings -> Signage Display -> Network Application -> SICP Network Port

Set up the default port of SICP and enable/disable the network SICP. The default SICP is enabled with the port 5000.

Note:

Port number ranges from 1025 ~ 65535.

The following ports are already occupied and cannot be assigned: 8000, 9988, 15220, 28123, 28124. The default FTP port is 2121.



5.1.2.5. System Tools

Settings -> Signage Display -> System Tools

There are eight major features in signage display system tools:

- (1). Navigation Bar (only when touch device is supported)
- (2). Clear Storage
- (3). Reset
- (4). Auto restart
- (5). Import & Export
- (6). Clone
- (7). Security
- (8). Admin Password

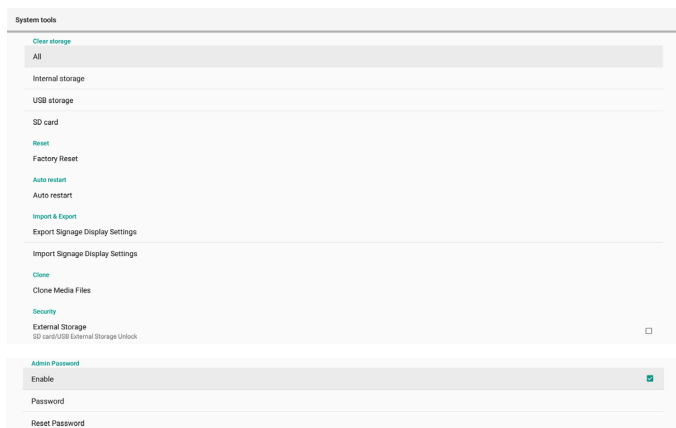

Navigation Bar

Settings -> Signage Display -> System Tools -> Navigation Bar

Set up to enable or disable navigation bar during touch gesture. This option is available only when platform supports touch device.

Clear Storage

Settings -> Signage Display -> System Tools -> Clear Storage



Clear data under {storage}/philips/folder of the internal and external storage.

- (1). All
Clear the folder “Philips” from the internal storage, USB and SD card.
- (2). Internal Storage
Clear the folder “Philips” from the internal storage only.
- (3). USB Storage
Clear the folder “Philips” from the USB storage only.
- (4). SD Card
Clear the folder “Philips” from the SD card only.

A dialog box lists all folders that the system is going to clear. Press “RESET” to clear all data under the listed folder, or press back key to quit without saving.

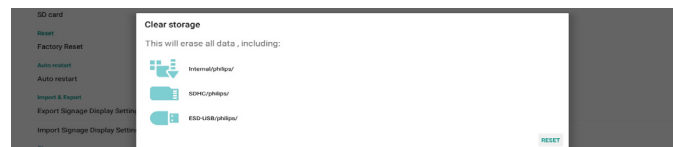

Reset

Settings -> Signage Display -> System Tools -> Reset

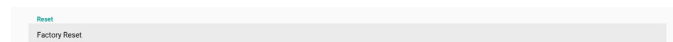

Factory Reset

This function allows you to clear all user data and settings. The system will auto reboot and jump to OOB after rebooting.

Important Note:

1. Only the data stored in the internal storage will be cleared and cannot be recovered, the data includes the device settings, installed APPs, APPs’ data, downloaded files, music, photos and all data under “/data”. However, the data stored on the USB and SD card will not be cleared.
2. Make sure that the AC adapter and power are always present during the factory reset process. User can only power off after seeing OOB on the screen.



Click “Factory Reset” to perform factory reset. Press “OK” to confirm when the dialog box appears. Please note this

action clears all data in the internal storage and it is not recoverable.



Auto Restart

Auto Restart function allows the device to restart automatically at the time you specify.

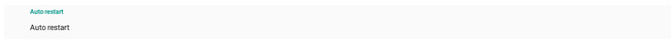

Select Disable/Enable auto restart feature from the Main Switch.

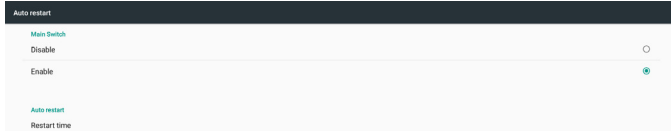

Use the time picker to set auto restart time.



Click “Save” button and the time you set for auto restart will display.

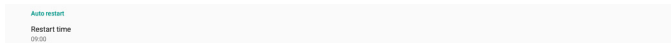

Import & Export

Settings -> Signage Display -> System Tools -> Import & Export

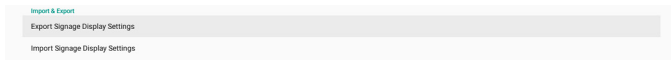

This function allows you to import/export the settings and 3rd party APK from/to other device. Please note that:

- (1). Export data to BDL3550Q-clone.zip file under {storage}/philips/clone folder.
- (2). Support old clone files method, and put files under {storage}/philips/sys_backup:
 - AndroidPDMediaPlayerData.db
 - AndroidPDPdfData.db
 - menu_settings.db
 - settings_global.xml
 - settings_secure.xml
 - settings_system.xml
 - signage_settings.db
 - smartcms.db
 Note that latest export data will archive all files into ZIP file.
- (3). “Signage Display Name” will not be imported/ exported.

Export Signage Display Settings

System exports database data and third party APKs into {storage}/philips/clone/BDL3550Q-clone.zip file of the selected storage (internal storage, SD card or USB storage).

Note:

If the selected storage (internal storage, USB or SD card) does not contain Philips/folder, then the system will create it automatically.

A list of all available storage (internal storage, SD card and USB storage):



Import Signage Display Settings

Import database data from philips/clone/BDL4550D-clone.zip file of the selected storage (internal Storage, SD Card or USB storage). System imports following data in ZIP file:

- (1). Import Database in BDL4550D-clone.zip
- (2). Import 3rd party APK in BDL4550D_clone.zip

A list of all available storage (internal storage, SD card and USB storage):



A confirmation dialog box is displayed before importing the settings and APKs. Click the “OK” button to start importing the data.

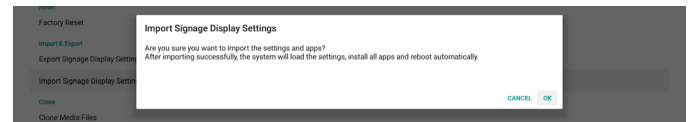

Clone

Settings -> Signage Display -> System Tools -> Clone

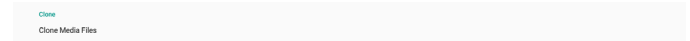

Clone Media Files

This function allows you to copy the media files from the selected source storage to the target storage.

- (1). System clone files are under the following folder:
 - philips/photo
 - philips/music
 - philips/video
 - philips/cms
 - philips/pdf
 - philips/browser
- (2). Clone CMS files (file extension is “.cms”):
 - Source storage
 - Source is internal storage
 - Check if there is CMS file on the FTP server.
 - If there is no CMS file on the FTP server, check philips/ folder in source storage
 - Source is external storage (SD card or USB storage)
 - Check CMS file in root directory of storage
 - Target storage
 - Target is internal storage
 - CMS file will be saved to philips/ folder
 - Target is external storage (SD card or USB storage)
 - CMS file will be saved to root directory of storage



Security

Settings -> Signage Display -> System tools -> Security

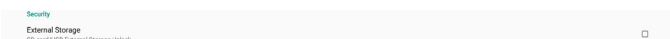

External Storage

Click the checkbox to lock or unlock external storage (SD card and USB storage). Default is unlocked.

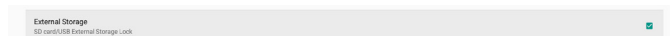

- (1). Unchecked (Disable): SD card/USB External Storage Unlock.
- (2). Checked (Enable): SD card/USB External Storage Lock.

Note:

When you disable external storage lock to enable state, please unplug and plugin external storage again (for both SD card and USB storage). After that, system can detect external storage again.

Admin Password

Settings -> Signage Display -> System tools -> Admin Password.



Enable:

Click the checkbox to enable or disable Admin Password. Default is disable. Once it is enabled, you will need a password to login into Admin mode. Default password is "1234".

Password:

Change the password if needed.

Reset Password:

Reset the password to its default value which is "1234". If reset is successful, it shows a message as "Successful".

5.1.2.6. Misc.

TeamViewer Support

Click the checkbox to enable or disable TeamViewer support. TeamViewer will send a virtual HOME key to open Admin mode. Default is enable.

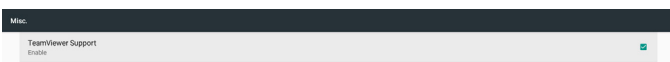

TeamViewerHost and TeamViewerQSAddOn APKs will be installed to the system automatically. Or, system will remove them if "TeamViewer Support" is disabled.

The following two APKs will be listed in Settings->Apps if "TeamViewer support" is enabled.



5.1.2.7. System updates

Local update

Settings -> Signage Display -> System updates -> Local update

System will auto search "update.zip" in root folder of USB disk and SD card. If "update.zip" is found on the external storage, a list will be shown for user to select the file to update.



Once the file is selected from the list, the system starts rebooting and updating.

Please note that:

- (1). Do not turn off the power or remove the power adapter until the update is complete.
- (2). Current system only supports full Android update.
- (3). The update file must be named as "update.zip" only.
- (4). The "update.zip" file must be stored in the root folder of your external storage.

5.1.3. Apps

Display installed APKs information.

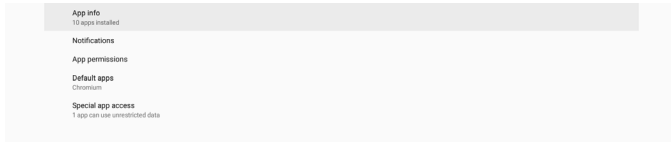

5.1.3.1. App info

All installed Android APP are listed. User can manage each APP's permission and other settings.



5.1.3.2. App permissions

List of major permission of Android system and the APP that has permission to control it.



5.1.3.3. Default Apps

User can set default APPs if someone sends related request.

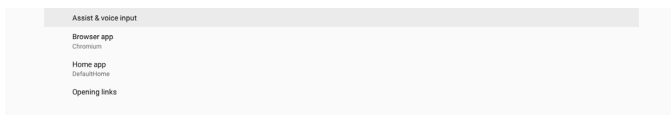

Browser app

The default APP to open a webpage URL. Default is Chromium.

Home app

The default launcher APP, default is DefaultHome APP. If user changes this APP, the external source may not display correctly.

Opening links

This feature allows the APP to open supported links inside its APP directly.

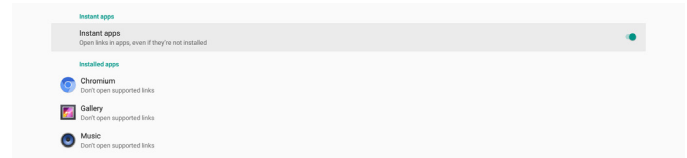

5.1.4. Display

Change the font size of your display.

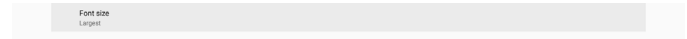

5.1.4.1. Font Size

Drag the slide to adjust system font size. Default setting is "Largest".

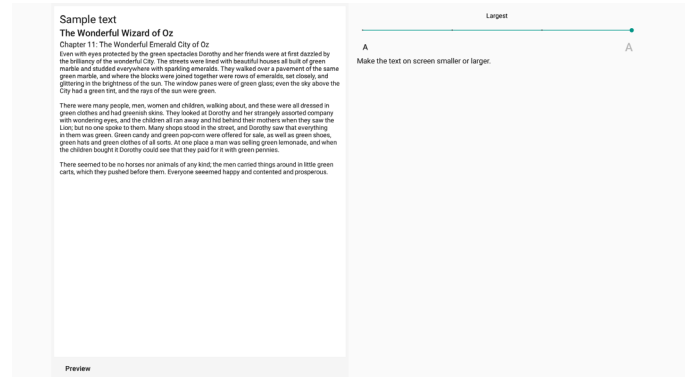

5.1.5. Security

Settings -> Security

List show app when it support admin related operations and control.

5.1.6. System

The following options are listed in Settings -> System.

- (1). Keyboard & inputs
- (2). Developer options
- (3). About

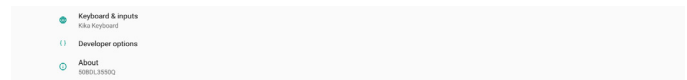

5.1.6.1. Keyboard & input

Settings -> System -> Keyboard & input

User can change IME and keyboard settings.

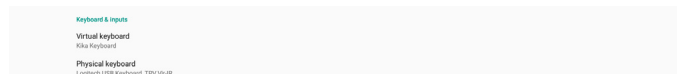

Virtual keyboard

Allow user to set default software IME (virtual keyboard) and control detailed IME settings.

Japanese IME will be installed automatically when Japanese language is selected in OOB.E.

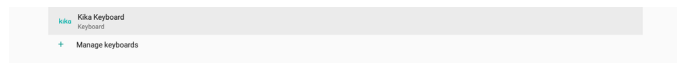

Physical keyboard

Allow user to control physical keyboard and detailed keyboard settings.

The “TPV Vir-IR” is a system-level virtual keyboard; it will always exist on the keyboard list.

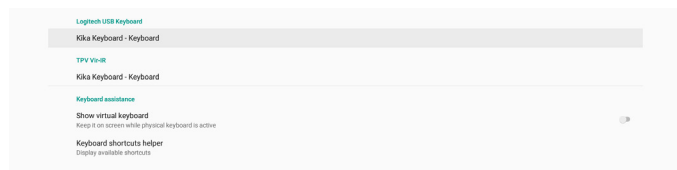

On-screen keyboard enable

Settings -> Languages & input -> On-screen keyboard enable

Used to enable/disable system pre-installed software keyboard (IME). User can press “menu” six times to enable on-screen software keyboard when it is disabled. By default, on-screen keyboard is enabled.

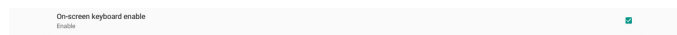

5.1.6.2. Developer options

Settings -> System -> Developer options

Android developer options for developers, default setting is On and USB debugging is also “On” by default.

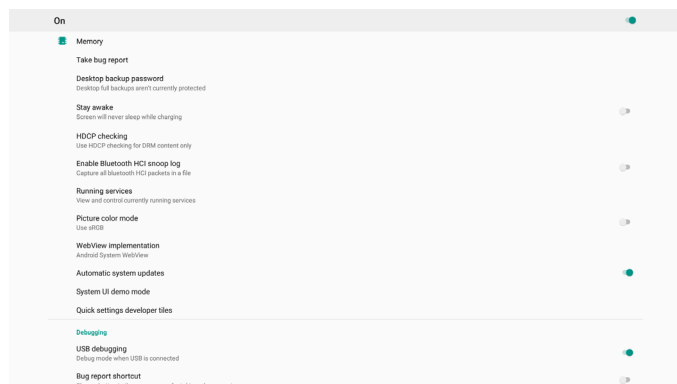

5.1.6.3. About

Settings -> System -> About

View the following information about the system.

- (1). Status
- (2).Legal information
- (3).Model (model name of this device)
- (4).Android version
- (5).Android security patch level
- (6).Kernel version
- (7).Build number (release version)

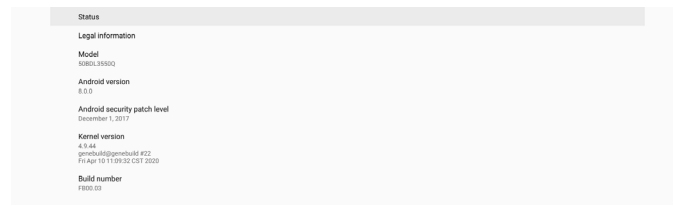

Status

Display device serial number and total time for the device to boot up.

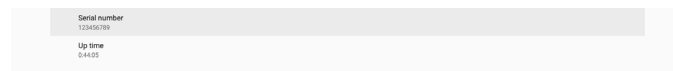

Legal Information

Legal information and licenses of all open source projects will be listed.

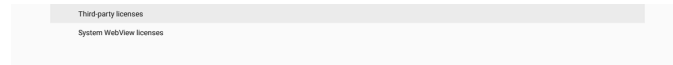

6. OSD Menu

An overview of the On-Screen Display (OSD) structure is shown below. You can use it as a reference for further adjustment of your display.

6.1. Navigating the OSD Menu

6.1.1. Navigating the OSD menu using the remote control

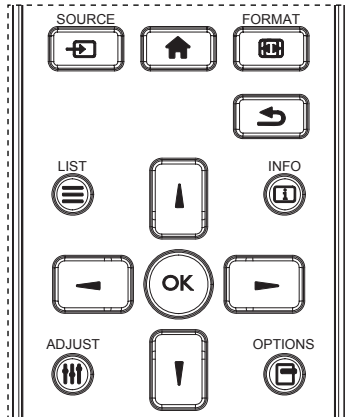

1. Press [HOME] button on the remote control to display the OSD menu.
2. Press [UP] or [DOWN] button to select the item to adjust.
3. Press [OK] or [RIGHT] button to enter the submenu.
4. In the submenu, press [UP] or [DOWN] button to toggle between items, press [LEFT] or [RIGHT] button to adjust the settings. If there is a submenu, press [OK] or [RIGHT] button to enter the submenu.
5. Press [LEFT] button to return to the previous menu, or press [HOME] button to exit from the OSD menu.

6.1.2. Navigating the OSD menu using the display's control buttons

1. Press [MENU] button to display the OSD menu.
2. Press [+] or [-] button to select the item to adjust.
3. Press [+] button to enter the submenu.
4. In the submenu, press [▲] or [▼] button to toggle between items, press [+] or [-] button to adjust the settings. If there is a submenu, press [+] button to enter the submenu.
5. Press [MENU] button to return to the previous menu, or keep pressing [MENU] button to exit from the OSD menu.

6.2. OSD Menu Overview

6.2.1. Picture menu

| | | |
|-----------------|-------------------|--------|
| Picture | Brightness | 90 |
| Screen | Contrast | 50 |
| Audio | Sharpness | 20 |
| Configuration 1 | Black level | 50 |
| Configuration 2 | Tint | 50 |
| Advanced option | Color | 55 |
| | Noise reduction | Medium |
| | Gamma selection | Native |
| | Color temperature | Native |
| | Color control | Action |
| | Smart power | Off |
| | Overscan | Off |

Brightness

Adjust the brightness of this display's backlight.

Contrast

Adjust the contrast ratio for the input signal.

NOTE: VIDEO source only

Sharpness

This function is digitally capable to keep a distinct image at all times.

Adjust the sharpness of the picture for each picture mode.

NOTE: VIDEO source only

Black level

Adjust the image brightness for the background.

NOTE: VIDEO source only. sRGB picture mode is standard and cannot be changed.

Tint (Hue)

Adjust the tint of the screen.

Press + button the flesh tone color becomes greenish.

Press - button the flesh tone color becomes purplish.

NOTE: VIDEO source only

Color (Saturation)

Adjust the color of the screen.

Press + button to increase color depth.

Press - button to decrease color depth.

NOTE: VIDEO source only

Noise reduction

Adjust the noise reduction level.

NOTE: VIDEO source only

Gamma selection

Select a display gamma. It refers to the brightness performance curve of signal input. Choose from {Native} / {2.2} / {2.4} / {s gamma} / {D-image}.

NOTE: VIDEO source only. sRGB picture mode is standard and cannot be changed.

Color temperature

Adjust the color temperature.

The image becomes reddish as the color temperature decreases, and becomes bluish as the color temperature increases.

NOTE: VIDEO source only.

Color Control

The color levels of red, green, and blue can be adjusted by the color bars.

R: Red gain, G: Green gain, B: Blue gain.

Smart power

Control of lower power consumption based on brightness setting.

- {OFF}: no adaptation
- {MEDIUM}: 80% of power consumption relative to current settings
- {HIGH}: 65% of power consumption relative to current settings

Overscan

If you encounter problems with overscanning, you can change display area of the image.

- {ON}: Display 95% of the total image area.
- {OFF}: Display 100% of the total image area.

NOTE: VIDEO source only.

Picture reset

Reset all settings in the Picture menu.

Select "RESET" to restore factory preset data.

Press "CANCEL" button to cancel and then return to the previous menu.

6.2.2. Screen menu

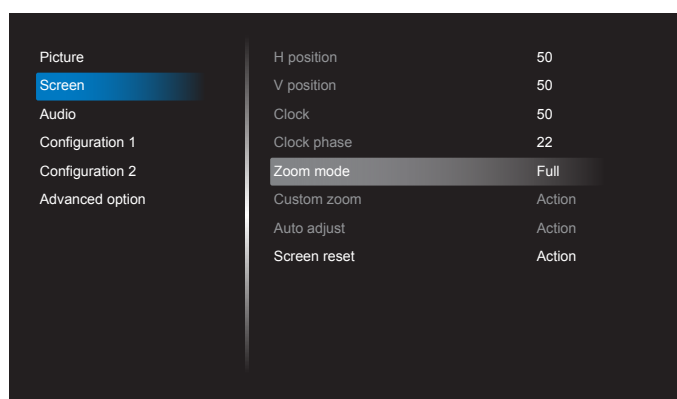

H position

Control Horizontal Image position within the display area of the LCD.

Press + button to move screen to right.

Press - button to move screen to left.

NOTE: VGA input only.

V position

Control Vertical Image position within the display area of the LCD.

Press + button to move screen to up.

Press - button to move screen to down.

NOTE: VGA input only.

Clock

Press + button to expand the width of the image on the screen to the right.

Press - button to narrow the width of the image on the screen to the left.

NOTE: VGA input only.

Clock Phase

Improves focus, clarity and image stability by increasing or decreasing this setting.

NOTE: VGA input only.

Zoom mode

Choose one for video input: {Full} / {Real} / {21:9} / {4:3} / {Custom}

| | |
|--|--|
| | Full This mode restores the correct proportions of pictures transmitted in 16:9 using the full screen display. |
| | Real This mode displays the image pixel-by-pixel on screen without scaling the original image size. |
| | 21:9 The picture is reproduced in 21:9 format and a black band at the top and bottom. |
| | 4:3 The picture is reproduced in 4:3 format and a black band is displayed on either side of the picture. |
| | Custom Choose to apply the custom zoom settings in the Custom Zoom submenu. |

Custom zoom

You can use this function to further customize the zoom settings to suit the image you want to display.

NOTE: This item is functional only when the {Zoom mode} is set to {Custom}.

| | |
|--|---|
| | Zoom Expands the horizontal and vertical sizes of the image simultaneously. |
| | H zoom Expands the horizontal size of the image only. |
| | V zoom Expands the vertical size of the image only. |

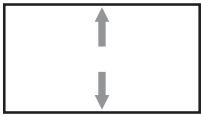
| | |
|--|--|
|  | H position Moves the horizontal position of the image left or right. |
|  | V position Moves the vertical position of the image up or down. |

Auto adjust

Press “Set” to detect and adjust H position, V position, Clock, Phase automatically.

NOTE: VGA input only.

Screen reset

Reset all settings in the Screen menu to factory preset values.

6.2.3. Audio menu

| | | |
|-----------------|----------------------|---------|
| Picture | Balance | 50 |
| Screen | Treble | 50 |
| Audio | Bass | 50 |
| Configuration 1 | Volume | 30 |
| Configuration 2 | Audio Out (Line Out) | 30 |
| Advanced option | Maximum Volume | 100 |
| | Minimum Volume | 0 |
| | Mute | Off |
| | Audio source | Digital |
| | Audio reset | Action |
| | Audio Out Sync | Off |

Balance

Adjust to emphasize left or right audio output balance.

Treble

Adjust to increase or decrease higher-pitched sounds.

Bass

Adjust to increase or decrease lower-pitched sounds.

Volume

Adjust the volume.

Audio Out (line out)

Adjust to increase or decrease the line out audio output level (volume).

NOTE: This function will be disabled when Audio Out Sync is ON.

Maximum volume

Adjust limitation for the maximum volume setting.

Minimum Volume

Adjust limitation for the minimum volume setting.

Mute

Turn the mute function on/off.

Audio Source

Select the audio input source.

{Analog}: audio from audio input.

{Digital}: audio from HDMI/DVI audio.

Audio reset

Reset all settings in the Audio menu to factory preset values.

Audio Out Sync

Line out volume sync with internal speaker Volume.

{On}: Enable the function and gray out Audio Out (line out) Volume.

{Off}: Disable the function.

Speaker Setting

Turn internal speaker {On}/{Off}.

6.2.4. Configuration 1 menu

| | | |
|-----------------|----------------------|----------|
| Picture | Switch on state | Force on |
| Screen | Panel saving | Action |
| Audio | RS232 routing | RS232 |
| Configuration 1 | Boot on source | Action |
| Configuration 2 | WOL | Off |
| Advanced option | Light sensor | Off |
| | Human sensor | Off |
| | Configuration1 reset | Action |
| | Factory reset | Action |

Switch on state

Select the display status when you connect the power cord next time.

- {Power off} – The display will remain off when the power cord is connected.
- {Forced on} – The display will turn on when the power cord is connected.
- {Last status} – The display will return to the previous power status (on/off/standby mode) when the power cord is connected.

Panel saving

Choose to enable the panel saving functions and thus reduce the risk of image persistence or ghost imaging.

- {Brightness} – Select {On} and the image brightness will reduce to an appropriate level. The Brightness setting in the Picture menu cannot be changed when this setting is enabled.
- {Pixel Shift} – Select the time interval ({Auto}, {10-900} seconds, {Off}) for display to slightly expand the image size and shift the position of pixels in four directions (up, down, left and right). Activating pixel shift will disable H position, V position and Zoom mode in Screen menu.

Note: Video source only.

RS232 routing

Select RS232 routing path

- {RS232} – RS232 is routed from 2.5mm phone jack
- {LAN->RS232} – RS232 is routed from RJ45

Boot on source

Choose to select a source when booting up.

- {Input} – Select input source when booting up.

- {Playlist} – Select playlist index for MediaPlayer, Browser, PDF Player. 0 indicates there is no playlist.

WOL (Wake on LAN)

Allow the display to be turned on by a network message.

Note: This function only works in power mode 1 and mode 2.

Light sensor

Choose to turn on or off the light sensor function of CRD41.

Human sensor

Choose to turn on or off the human sensor function of CRD41.

Configuration 1 reset

Reset all settings in Configuration 1 menu to factory preset values.

Factory Reset

Reset all customized settings in Picture, Screen, Audio, Configuration 1, Configuration 2 and Advanced Option to the factory default values.

6.2.5. Configuration 2 menu

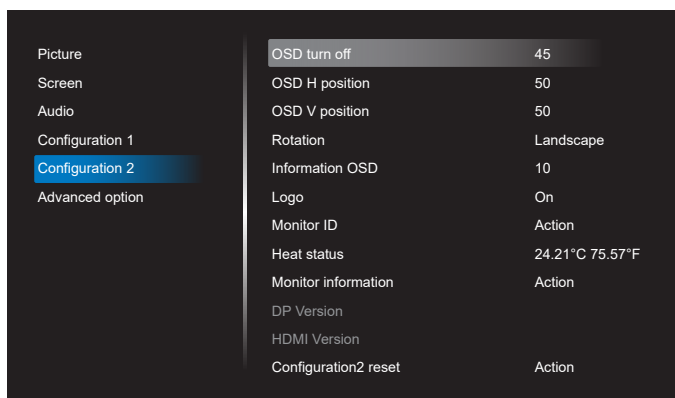

OSD turn off

Set the period of time the OSD (on-screen display) menu stays on the screen.

The options are {Off, 5 - 120} seconds. {Off} does not disappear automatically.

OSD H position

Adjust the horizontal position of the OSD menu.

OSD V position

Adjust the vertical position of the OSD menu.

Rotation

Change OSD and Android to Landscape / Portrait mode.

Note: Video inputs will not rotate with this setting.

Note: If Android APK plays video content, user MUST stop and re-play to get correct video image.

Information OSD

Set the period of time the information OSD display on the upper left corner of the screen. The information OSD will display when input source and signal are changed.

The options are {Off, 1 - 60} seconds.

Logo

Choose to enable or disable the picture of Logo when turning on your display.

- {Off} – Both static Philips logo and Android boot animation will not be shown.
- {On} – Default value. Both Philips logo and Android boot animation will be shown.
- {User} – Static Philips logo will not be shown, only user-selected boot animation will be shown in Android settings.

Note: Logo will not be rotated even though rotation setting is set.

Monitor ID

Set the ID number for controlling the display via the RS232 connection. Each display must have a unique ID number when multiple sets of the display are connected. Monitor ID number range is between 1 and 255.

- {Monitor ID} set range in {1-255}. The default setting is 1.
- {Monitor group} set range in {1-254}. The default setting is 1.

Heat Status

Current thermal status.

Monitor information

Shows information about your display, including model name, SW version, serial number, and operation hours.

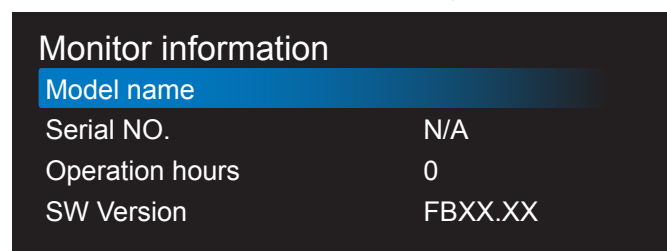

DP version

Change DP version. 1.1 or 1.2.

HDMI version

Set the HDMI version to 1.4 or 2.0.

Note: HDMI input source only.

Configuration 2 reset

Reset all settings in Configuration 2 menu to factory preset values.

6.2.6. Advanced Option menu

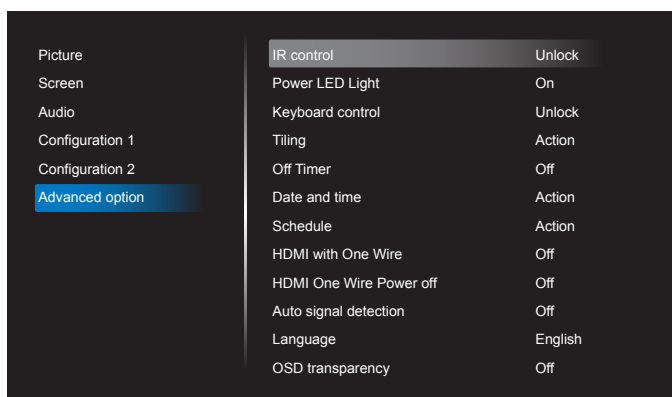

IR control

Select the operation mode of the remote control when multiple displays are connected via RS232 connection.

- {Unlock} - All displays can be operated normally by the remote control unit.
- {Primary} - Designate this display as the primary display for remote control operation. Only this display can be operated by the remote control. (In primary mode, IR key will always be processed regardless of the monitor ID/group settings).
- {Secondary} - Designate this display as the secondary display. This display cannot be operated by the remote control, and will only receive the control signal from the primary display via RS232 connection.
- {Lock All} / {Lock all but Volume} / {Lock all but Power} / {Lock all except PWR & VOL} - Lock the remote control function of this display. To unlock, press and hold the INFO button on the remote control for 6 (six) seconds.

Power LED light

Choose to set power indication LED on or off.

Choose {On} for normal use.

Keyboard control

Choose to enable or disable the display keyboard (control buttons) function.

- {Unlock} - Enable the keyboard function.
- {Lock All} / {Lock all but Volume} / {Lock all but Power} / {Lock all except PWR & VOL} - Disable the keyboard function.

NOTE: "Keyboard Control Lock Mode" This function completely disables the access to all Keyboard Control functions. To enable or disable the keyboard control lock, press both [VOL+] and [UP] buttons and hold down continuously more than 3 seconds.

Tiling

Create a single large-screen matrix (video wall) that consists of up to 150 sets of the display (up to 10-sets on the vertical and 15-sets on the horizontal sides). This function requires daisy-chain connection.

- **Switch on Delay:** Set the power-on delaying time (in seconds). Default option {Auto} allows a sequential powering-on for each display by monitor ID when multiple displays are connected. The options are: {Off, Auto, 2-255}.
- **Brightness:** {Normal} – Adjust the overall image and background screen brightness (backlight) in Screen menu. {ACS} – Apply brightness values (backlight) which is adjusted by MIC tool. The default value before adjustment is the same as brightness setting in Screen menu.
- **H monitors:** Select the number of displays in horizontal side.
- **V monitors:** Select the number of displays in vertical side.
- **Position:** Select the position of this display in the screen matrix.

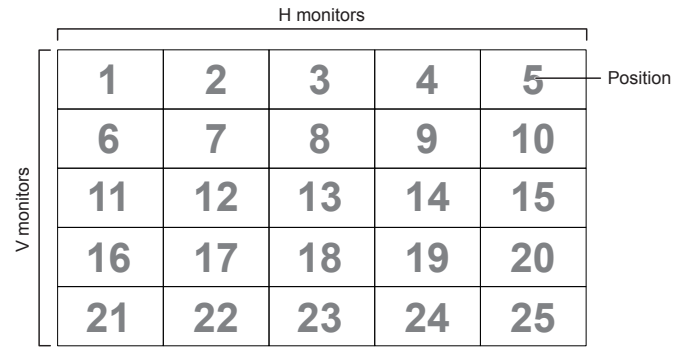

- **Frame comp.:** Turn frame compensation function on and off. The display adjusts the image to compensate the width of display bezels for accurately display the image. With frame compensation:

{On}

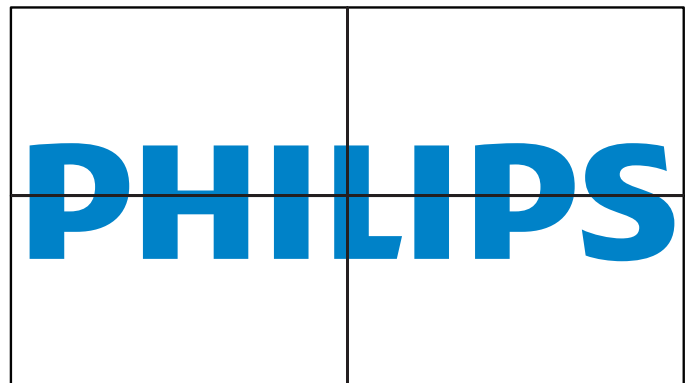

{Off}

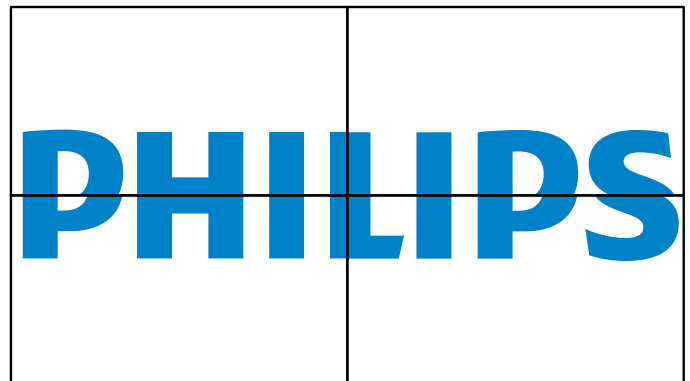

- **Enable:** Check to enable tiling function.

Off timer

Set automatic power off time (in hours).

Date and time

Adjust the current date and time for the display's internal clock.

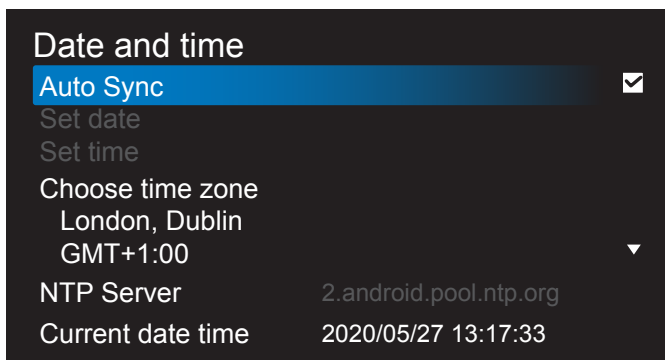

- {Auto Sync} – Auto sync display's clock with NTP server.

Schedule

Allow user setup up to seven different scheduled intervals of display activity.

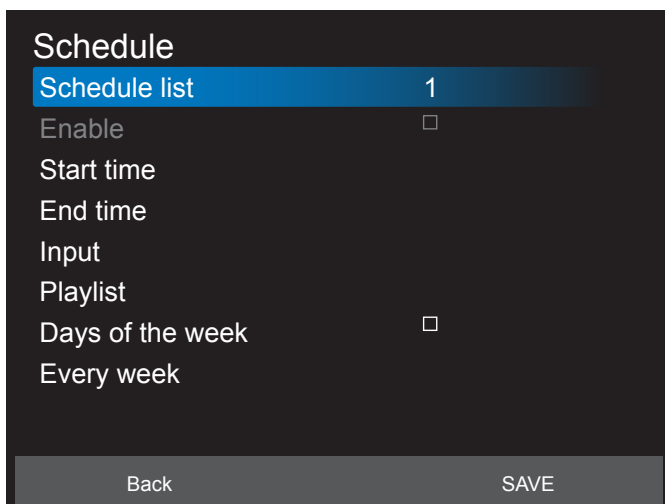

- {Schedule list} – Select 1-7 schedules to edit.
- {Enable} – Enable/disable selected schedule. If time conflict with other schedule or start/end time, input source are empty, user cannot enable this schedule.
- {Start time} – Set start time.
- {End time} – Set end time.
- {Input} – Set input source, system will go to selected source automatically at start time.
- {Play list} – Set playlist 1-7 for MediaPlayer, PDF Player and Browser sources.
- {Days of the week} – Set Sunday, Monday, Tuesday, Wednesday, Thursday, Friday and Saturday.
- {Every week} – Set lifecycle.
- {Back} – Cancel and do not change schedule data.
- {SAVE} – Save schedule data.

HDMI with One Wire

Enable or disable HDMI CEC.

HDMI One Wire Power Off

Allow user to set multiple devices to standby mode by pressing the power button. This function is only available when HDMI CEC is enabled.

Language

Select the language used in the OSD menu.

The options are: English/Deutsch/ 简体中文 /Français/ Italiano/Español/Русский/Польски/Türkçe/ 繁體中文 / 日本語 /Português/عربي/ Danish/Swedish/Finnish/Norwegian/ Dutch/Czech/Lithuanian/Latvian/Estonian.

OSD Transparency

Adjust OSD transparency.

- {Off} – Transparency off.
- {1-100} – Transparency level 1-100

Power Save

Mode 1 [TCP off, WOL on, auto off]

Mode 2 [TCP off, WOL on, auto on/off]

Mode 3 [TCP on, WOL off, auto on/off]

Mode 4 [TCP on, WOL off, no auto on/off]

| Power Save | RCU Power Button Off | No Signal | WOL | Android (ARM) |
|------------|----------------------|-------------------------------------|-----|---------------|
| Mode 1 | DC OFF | DC OFF | V | ARM off |
| Mode 2 | DC OFF | when signal is back, system wake up | V | ARM off |
| Mode 3 | Backlight OFF | when signal is back, system wake up | X | ARM on |
| Mode 4 | Backlight OFF | Backlight always on, show no signal | X | ARM on |

Following table is the action for Android board with different power mode.

| Power mode | Mode 1, Mode 2 | Mode 3, Mode 4 |
|------------|-----------------|--|
| DC off | System shutdown | 1. Media Player, Browser, PDF Player and SmartCMS will close. 2. Android system goes to default black launcher. |
| DC on | System boot up | Android system reboot. If Logo settings is off, system directly turn backlight on without rebooting. |

Advanced option reset

Reset all settings except {Date and Time} in the advanced option menu to factory preset values.

7. Supported Media Formats

USB Multimedia Formats

| Video format | | |
|--------------|-----------------|----------|
| Video Codec | Resolution | Bit Rate |
| MPEG1/2 | 1080P@30fps | 40Mbps |
| MPEG4 | 1080P@30fps | 40Mbps |
| H.263 | 1080P@30fps | 40Mbps |
| H.264 | 4k2k@60fps | 135Mbps |
| H.265 | 4K2K@60fps | 100Mbps |
| VP8 | 1920x1080@30fps | 50Mbps |

| Audio format | | | |
|--------------------|----------------|---------|---|
| Audio Codec | Sampling Rate: | Channel | Bit Rate |
| MPEG1/2/2.5 Layer3 | 8KHz-48KHz | 2 | 8Kbps-320Kbps |
| MPEG1/2 Layer1 | 16KHz-48KHz | 2 | 32Kbps-448Kbps |
| MPEG1/2 Layer2 | 16KHz-48KHz | 2 | 8Kbps-384Kbps |
| AAC, HEAAC | 8KHz-48KHz | 5.1 | AAC-LC: 12Kbps-576Kbps V1:6Kbps-288Kbps V2:3Kbps-144Kbps |

| Photo format | | |
|--------------|---------------|--------------|
| Image | Photo | Resolution |
| JPEG | Base-line | 1920 x 1080 |
| | Progressive | 1024 x 768 |
| PNG | non-interlace | 1920 x 1080 |
| | interlace | 1920 x 1080 |
| BMP | | 15360 x 8640 |

NOTES:

- Sound or video may not work if the contents have a standard bit rate/frame rate above the compatible Frame/sec listed in the table above.
- Video content with a Bit rate or Frame rate larger than the rate specified in the table above can cause choppy video during playback.

8. Input Mode

Timing support:

| Item | Resolution | H.Freq. (KHz) | V.Freq. (Hz) |
|------|----------------------------------|---------------|--------------|
| 1 | 720×400 @70Hz DOS | 31.469 | 70.087 |
| 2 | 640×480 @60Hz DMT | 31.469 | 59.94 |
| 3 | 640×480 @67Hz MAC | 35 | 66.667 |
| 4 | 640×480 @75Hz DMT | 37.5 | 75 |
| 5 | 800×600 @60Hz DMT | 37.879 | 60.317 |
| 6 | 832×624 @75Hz MAC | 49.725 | 74.5 |
| 7 | 1024×768 @60Hz DMT | 48.363 | 60.004 |
| 8 | 1152×870 @75Hz MAC | 68.681 | 75.062 |
| 9 | 1280×720 @60Hz CVT16:9 | 44.772 | 59.855 |
| 10 | 1280×1024 @60Hz DMT | 63.981 | 60.02 |
| 11 | 1440×900 @60Hz CVT16:10 R | 55.469 | 59.901 |
| 12 | 1440×900 @60Hz CVT16:10 | 55.935 | 59.887 |
| 13 | 1680×1050 @60Hz CVT16:9 R | 64.674 | 59.883 |
| 14 | 1680×1050 @60Hz CVT16:9 | 65.29 | 59.954 |
| 15 | 1920×1080 @60Hz CVT-RB / XBOX360 | 66.7 | 60 |
| 16 | 1920×1080 @60Hz DMT-RB | 67.5 | 60 |
| 17 | 480i@60Hz | 15.734 | 59.94 |
| 18 | 480P@60Hz | 31.469 | 59.94 |
| 19 | 720P@60Hz | 44.955 | 59.94 |
| 20 | 1080I@60Hz | 33.716 | 59.94 |
| 21 | 1080P@60Hz | 67.433 | 59.94 |
| 22 | 576i@50Hz | 15.625 | 50 |
| 23 | 576P@50Hz | 31.25 | 50 |
| 24 | 720P@50Hz | 37.5 | 50 |
| 25 | 1080I@50Hz | 28.125 | 50.08 |
| 26 | 1080P@50Hz | 56.25 | 50 |

- The PC text quality is optimum in FHD mode (1920 x 1080, 60Hz).
- Your PC display screen might appear different depending on the manufacturer (and your particular version of Windows).
- Check your PC instruction book for information about connecting your PC to a display.
- If a vertical and horizontal frequency-select mode exists, select 60Hz (vertical) and 31.5KHz (horizontal). In some cases, abnormal signals (such as stripes) might appear on the screen when the PC power is turned off (or if the PC is disconnected). If so, press the [INPUT] button to enter the video mode. Also, make sure that the PC is connected.
- When horizontal synchronous signals seem irregular in RGB mode, check PC power saving mode or cable connections.
- The display settings table complies to the IBM/VESA standards, and based on the analog input.
- The DVI support mode is regarded as same to the PC support mode.
- The best timing for the vertical frequency to each mode is 60Hz.

9. Pixel Defect Policy

We strive to deliver the highest quality products and use some of the industry's most advanced manufacturing processes whilst practicing stringent quality control. However, pixel or sub-pixel defects on the PDP / TFT panels used in Plasma- & LCD- displays are sometimes unavoidable. No manufacturer can guarantee that all panels will be free from pixel defects, but Philips guarantees that any Plasma- & LCD- displays with an unacceptable number of defects will be repaired during the warranty period in line with your local guarantee conditions.

This notice explains the different types of pixel defects and defines the acceptable defect level for the LCD screen. In order to qualify for repair under warranty, the number of pixel defects must exceed a certain level as shown in the reference table. If the LCD screen is within specification a warranty exchange / claim back will be refused. Additionally, because some types or combinations of pixel defects are more noticeable than others, Philips sets even higher quality standards for those.

9.1. Pixels and Sub-Pixels

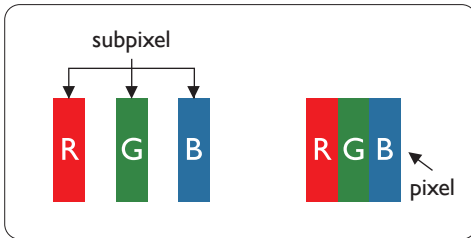

A pixel, or picture element, is composed of three sub-pixels in the primary colors of red, green and blue. Many pixels together form an image. When all sub-pixels of a pixel are lit, the three colored sub-pixels together appear as a single white pixel. When all are dark, the three colored sub-pixels together appear as a single black pixel. Other combinations of lit and dark sub-pixels appear as single pixels of other colors.

9.2. Types of Pixel Defects + Dot Definition

Pixel and sub-pixel defects appear on the screen in different ways. There are three categories of pixel defects and several types of sub-pixel defects within each category.

Dot definition = What is a defective “Dot”? :

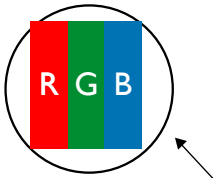

One or more defective, adjacent sub-pixel are defined as one “dot”. The no. of defective sub-pixels are not relevant to define a defective dot. This means that a defective dot can consist of one, two or three defective sub-pixels which can be dark or lit.



One dot = One Pixel; consists of three sub-pixels of Red, Green, and Blue.

9.3. Bright Dot Defects

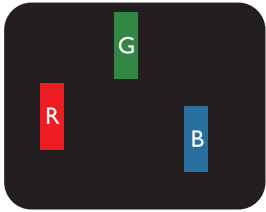
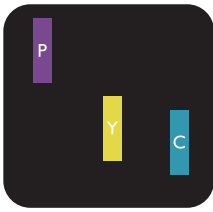
Bright dot defects appear as pixels or sub-pixels that are always lit or “on”. These are the examples of bright dot defects:

| | | |
|---|---|--|
|  <p>One lit red, green or blue sub pixel</p> |  <p>Two adjacent lit sub pixels: Red + Blue = Purple Red + Green = Yellow Green + Blue = Cyan (Light Blue)</p> |  <p>Three adjacent lit sub pixels (one white pixel)</p> |
|---|---|--|

9.4. Dark Dot Defects

Black dot defects appear as pixels or sub-pixels that are always dark or “off”. These are the examples of black dot defects:

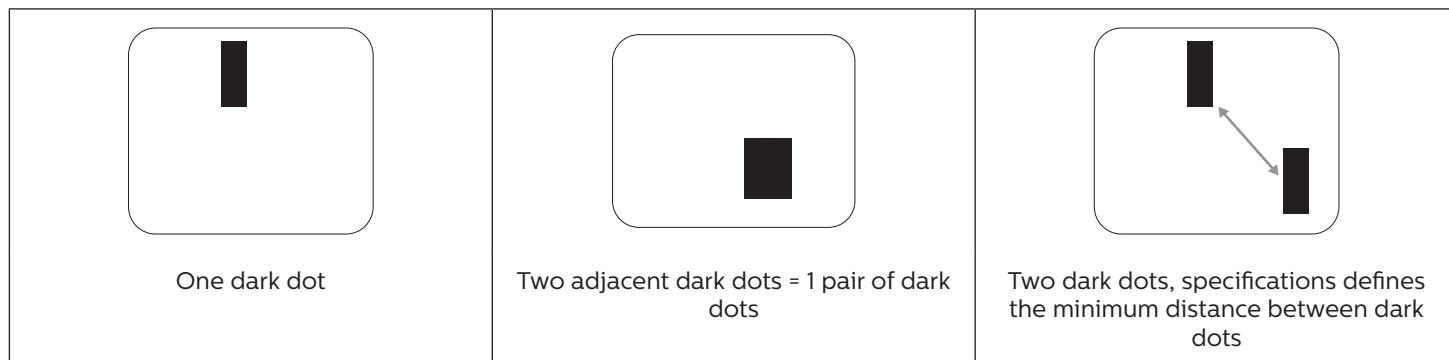

9.5. Proximity of Pixel Defects

Because pixel and sub-pixels defects of the same type that are nearby one another may be more noticeable, Philips also specifies tolerances for the proximity of pixel defects. In the table below you can find specifications about:

- Allowed amount of adjacent dark dots = (adjacent dark dots =1 pair of dark dots)
- Minimum distance between dark dots
- Total no. of all defective dots

9.6. Pixel Defect Tolerances

In order to qualify for repair due to pixel defects during the warranty period, a PDP / TFT panel in a Philips Plasma / LCD-display must have pixel or sub-pixel defects exceeding the tolerances listed in the following table.

| BRIGHT DOT EFFECT | ACCEPTABLE LEVEL |
|--------------------------------|------------------|
| 1 lit sub pixel | 2 |
| BLACK DOT EFFECT | ACCEPTABLE LEVEL |
| 1 dark sub pixel | 10 |
| TOTAL DOT DEFECTS OF ALL TYPES | 12 |

NOTE: * 1 or 2 adjacent sub pixel defects = 1 dot defect

9.7. MURA

Dark spots or patches may occasionally appear on some liquid crystal display (LCD) panels. This is known within the industry as Mura, which is a Japanese term for “unevenness.” It is used to describe an irregular pattern or area in which uneven screen uniformity appears under certain conditions. Mura is a result of the deterioration of the liquid crystal alignment layer and is most commonly caused by long-term operation under high ambient temperatures. It is an industry- wide phenomenon and Mura is not repairable. It is also not covered by our warranty terms.

Mura has been around since the introduction of LCD technology and with screens getting bigger and in operation 24/7, many displays are running in low light conditions. This all adds to the possibility of Mura affecting displays.

HOW TO SPOT MURA

There are many symptoms of Mura and also multiple causes. Several of these are listed below:

- Impurities or foreign particles in the crystal matrix
- Uneven distribution of LCD matrix during manufacturing
- Non-uniform luminance distribution of the backlight
- Panel assembly induced stress
- Flaws within the LCD cells
- Thermal induced stress - high temperature operation over long periods of time

HOW TO AVOID MURA

Although we can not guarantee the complete eradication of Mura every time, in general the appearance of Mura can be minimized by these methods:

- Lower the backlight brightness
- Use a screen saver
- Reduce the ambient temperature around the unit

10. Cleaning and Troubleshooting

10.1. Cleaning

Caution When Using the Display

- Do not bring your hands, face or objects close to the ventilation holes of the display. The top of the display is usually very hot due to the high temperature of exhaust air being released through the ventilation holes. Burns or personal injuries may occur if any body parts are brought too close. Placing any object near the top of the display could also result in heat related damage to the object as well as the display itself.
- Be sure to disconnect all cables before moving the display. Moving the display with its cables attached may damage the cables and thus cause fire or electric shock.
- Disconnect the power plug from the wall outlet as a safety precaution before carrying out any type of cleaning or maintenance procedure.

Front Panel Cleaning Instructions

- The front of the display has been specially treated. Wipe the surface gently using only a cleaning cloth or a soft, lint-free cloth.
- If the surface becomes dirty, soak a soft, lint-free cloth in a mild detergent solution. Wring the cloth to remove excess liquid. Wipe the surface of the display to remove dirt. Then use a dry cloth of the same type to dry.
- Do not scratch or hit the surface of the panel with fingers or hard objects of any kind.
- Do not use volatile substances such as insert sprays, solvents and thinners.

Cabinet Cleaning Instructions

- If the cabinet becomes dirty, wipe the cabinet with a soft, dry cloth.
- If the cabinet is extremely dirty, soak a lint-free cloth in a mild detergent solution. Wring the cloth to remove as much moisture as possible. Wipe the cabinet. Use another dry cloth to wipe over until the surface is dry.
- Do not use solution that contains oil to clean the plastic parts. Such product damage the plastic parts and void the warranty.
- Do not allow any water or detergent to come into contact with the surface of the display. If water or moisture gets inside the unit, operating problems, electrical and shock hazards may result.
- Do not scratch or hit the cabinet with fingers or hard objects of any kind.
- Do not use volatile substances such as insert sprays, solvents and thinners on the cabinet.
- Do not place anything made from rubber or PVC near the cabinet for any extended periods of time.

10.2. Troubleshooting

| Symptom | Possible Cause | Remedy |
|---|---|--|
| No picture is displayed | <ol style="list-style-type: none"> 1. The power cord is disconnected. 2. The main power switch on the back of the display is not switched on. 3. The selected input has no connection. 4. The display is in standby mode. | <ol style="list-style-type: none"> 1. Plug in the power cord. 2. Make sure the power switch is switched on. 3. Connect a signal connection to the display. |
| Interference displayed on the display or audible noise is heard | Caused by surrounding electrical appliances or fluorescent lights. | Move the display to another location to see if the interference is reduced. |
| Color is abnormal | The signal cable is not connected properly. | Make sure that the signal cable is attached firmly to the back of the display. |
| Picture is distorted with abnormal patterns | <ol style="list-style-type: none"> 1. The signal cable is not connected properly. 2. The input signal is beyond the capabilities of the display. | <ol style="list-style-type: none"> 1. Make sure that the signal cable is attached firmly. 2. Check the video signal source to see if it is beyond the range of the display. Please verify its specifications with this display's specification section. |
| Display image doesn't fill up the full size of the screen | <ol style="list-style-type: none"> 1. The zoom mode is not set correctly. 2. Scan Mode may be set incorrectly to underscan. 3. If the image exceeds the screen size, Scan Mode may need to be set to Underscan. | Use the Zoom mode or Custom zoom function in the Screen menu to fine tune display geometry and time frequency parameter. |
| Can hear sound, but no picture | Source signal cable is connected improperly. | Make sure that both video inputs and sound inputs are correctly connected. |
| Can see picture but no sound is heard | <ol style="list-style-type: none"> 1. Source signal cable is connected improperly. 2. Volume is turned all the way down. 3. {Mute} is turned on. 4. No external speaker connected. | <ol style="list-style-type: none"> 1. Make sure that both video inputs and sound inputs are correctly connected. 2. Press [+] or [-] button to hear sound. 3. Switch MUTE off by using the  button. 4. Connect external speakers and adjust the volume to a suitable level. |
| Some picture elements do not light up | Some pixels of the display are off. | This display is manufactured using an extremely high level of precision technology: however, sometimes some pixels of the display may not display. This is not a malfunction. |
| After-Images can still be seen on the display after the display is powered off. (Examples of still pictures include logos, video games, computer images, and images displayed in 4:3 normal mode) | A still picture is displayed for an over extended period of time | Do not allow a still image to be displayed for an extended period of time as this can cause a permanent after-image to remain on the display. |

11. Warranty Statement

Warranty period for PHILIPS signage display is listed as below, for areas not covered in this table, please follow their warranty statement.

| Region | Warranty Period |
|---------------|------------------------|
| USA, Canada | 3 years |
| China | 1 year |
| Asia Pacific | 3 years |
| Europe | 3 years |
| Brazil | 3 years |

12. Technical Specifications

Display:

| Item | Specifications |
|---------------------------|--------------------------------|
| Screen Size (Active Area) | 800mm / 31.5 inch |
| Aspect Ratio | 16:9 |
| Number of pixels | 1920 (H) x 1080 (V) |
| Pixel pitch | 0.36375 (H) x 0.36375 (V) [mm] |
| Displayable colors | 8 bits, 16.7 million colors |
| Brightness (typical) | 400 cd/m ² |
| Contrast ratio (typical) | 1200:1 |
| Viewing angle | 178 degrees |

In/Out Terminals:

| Item | Specifications | |
|--------------------|--|---|
| Speaker Output | Internal Speakers | 10W (L) + 10W (R) [RMS]/8Ω 82 dB/W/M/160 Hz - 13 KHz |
| Audio Output | 3.5mm phone jack x 1 | 0.5V [rms] (Normal) / 2 Channel (L+R) |
| Audio Input | 3.5mm phone jack x 1 | 0.5V [rms] (Normal) / 2 Channel (L+R) |
| RS232 | 2.5mm Phone jack x 2 | RS232 in/RS232 out |
| RJ-45 | RJ-45 Jack x 1 (8 pin) | 10/100 LAN Port |
| HDMI Input /Output | HDMI Jack x 3 (Type A) (19 pin) (HDMI in x 2 & HDMI out x 1) | Digital RGB: TMDS (Video + Audio) MAX: Video - 720p, 1080p, 3840 x 2160/60 Hz Audio - 48 KHz/ 2 Channel (L+R) Supports LPCM only |
| DP Input /Output | DP Jack x 2 (DP in x 1 & DP out x 1) | Digital RGB: TMDS (Video + Audio) MAX: Video - 720p, 1080p, 3840 x 2160/60 Hz Audio - 48 KHz/ 2 Channel (L+R) |
| DVI-I Input | DVI-I Jack | Digital RGB: TMDS (Video) Analog RGB: 0.7V [p-p] (75Ω), H/CS/V: TTL (2.2kΩ), MAX: 1920 x 1080/60 Hz (WUXGA) |
| IR Input/Output | 3.5mm x 2 | IR pass through |
| USB Input | USB x 2 (Type A) | USB 2.0, Multimedia play and service port |

General:

| Item | Specifications |
|---|-------------------------|
| Power Input | 100 - 240V~, 50/60Hz |
| Power Consumption (Max) | 85 W |
| Power Consumption (typ.) | 44 W |
| Power Consumption (Standby Mode & Off Mode) | <0.5 W |
| Dimensions [W x H x D] | 726.5 x 425.4 x 69.1 mm |
| Weight | 5.7 Kg |
| Gross Weight | 8.1 Kg |
| Energy Efficiency Class | B |
| Visible Screen Size | 800 mm / 31.5 inch |
| On Mode Power Consumption (W) | 48 W |
| Annual Energy Consumption (kWh) | 70 kWh |
| Standby Mode Power Consumption (W) | 0.5 W |
| Off Mode Power Consumption (W) | 0.3 W |
| Display Resolution (Pixels) | 1920 x 1080 |

Environmental Condition:

| Item | | Specifications |
|-------------|--------------------|-------------------------------|
| Temperature | Operational | 0 - 40°C |
| | Storage | -20 - 60°C |
| Humidity | Operational | 20 - 80% RH (No condensation) |
| | Storage | 5 - 95% RH (No condensation) |
| Altitude | Operational | 0 - 3,000 m |
| | Storage / Shipment | 0 - 9,000 m |



2021 © TOP Victory Investments Ltd. All rights reserved.

This product has been manufactured by and is sold under the responsibility of Top Victory Investments Ltd., and Top Victory Investments Ltd. is the warrantor in relation to this product. Philips and the Philips Shield Emblem are registered trademarks of Koninklijke Philips N.V. and are used under license.

Specifications are subject to change without notice.

Version: V1.01 2021-04-22