



COMFORT...BUILT TO LAST

10,000, 12,000 & 14,000 BTU

THRU-THE-WALL AIR CONDITIONER

USER MANUAL

FOR MODELS:

3PATWH10002

with 10,600 BTU electric heater

3PATWH12002

with 10,600 BTU electric heater

3PATWH14002

with 10,600 BTU electric heater

3PATW14002

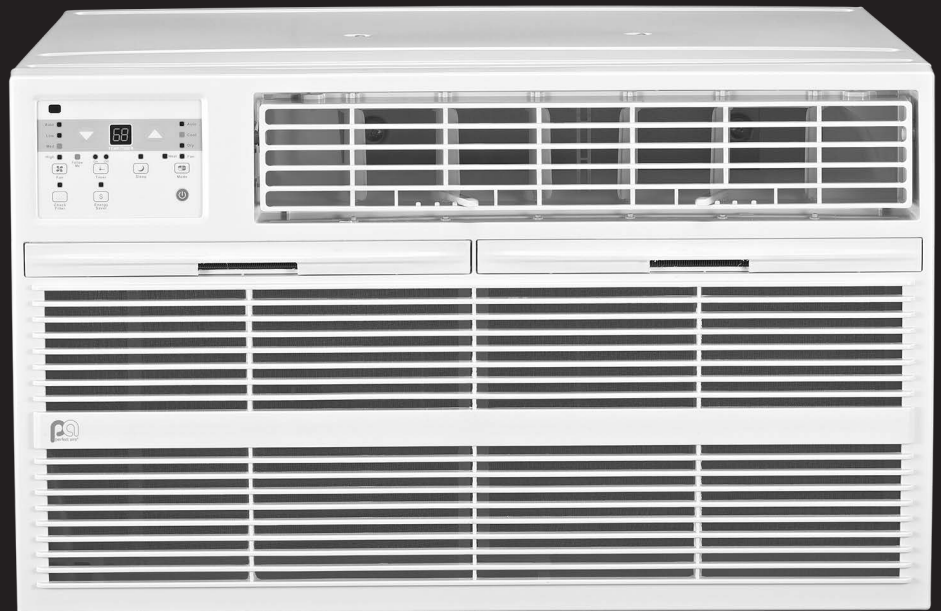

Before using your thru-the-wall air conditioner, please read this manual carefully and keep it for future reference, along with your receipt.

CONTENTS

SAFETY PRECAUTIONS	2
IMPORTANT SAFETY INSTRUCTIONS	4
NORMAL SOUNDS	5
AIR CONDITIONER FEATURES	5
INSTALLATION INSTRUCTIONS	8
CARE AND CLEANING	22
TROUBLESHOOTING TIPS	23

This manual provides the information needed for proper use and maintenance of this air conditioner. Basic preventative care can help extend the life of this unit. The “Troubleshooting Tips” section in this manual contains a chart with solutions to the most common problems. Referring to this section may save time and prevent the need for a service call in the event of a problem.

CAUTION



- Contact a qualified service technician for repair or maintenance of this unit.
- Contact an installer for installation of this unit if necessary.
- ***The air conditioner is not intended for use by young children without supervision.***
Young children should be supervised to ensure that they do not play with the air conditioner.
- Disabled persons may require assistance with set up.
- If the power cord is to be replaced, replacement work should be performed by authorized personnel only.
- Installation and repair work must be performed in accordance with the national wiring standards by qualified professionals only.
- Do not operate your air conditioner in a wet room such as a bathroom or laundry room.
- Units with a heating function should be at least 3¹/₃ ft (1 meter) away from any combustible/flammable materials.

NOTE: *All the illustrations in this manual are for explanation purposes only. Unit purchased may be slightly different.*



The design and specifications are subject to change without prior notice for product improvement. Contact customer service for details.

SAFETY PRECAUTIONS

To prevent injury to the user or other people and property damage, the following instructions must be followed. Incorrect operation due to ignoring of instructions may cause harm or damage. The seriousness is classified by the following indications.

 WARNING	This symbol indicates the possibility of death or serious injury.
 CAUTION	This symbol indicates the possibility of injury or damage to property.

■ Meanings of symbols used in this manual are as shown below.

	Never do this.
	Always do this.

WARNING

 **Plug in power plug properly.**

● Failure to do so may cause electric shock or fire due to excess heat generation.

 **Do not operate or stop the unit by inserting or pulling out the power plug directly from the wall.**

● Doing so may cause electric shock or fire due to heat generation.

 **Do not use a damaged power cord.**

● Doing so may cause electric shock or fire. If the power cord is damaged, it must be replaced by the manufacturer or an authorized service center or a similarly qualified person in order to avoid a hazard.

 **Do not modify power cord length or share the outlet with other appliances.**

● Doing so may cause electric shock or fire due to heat generation.

 **Do not operate with wet hands or in damp environment.**

● Doing so may cause electric shock.

 **Do not direct airflow directly at room occupants.**

● This could cause health issues.

 **Always ensure effective grounding.**

● Incorrect grounding may cause electric shock.

 **Do not allow water to run into electric parts.**

● Doing so may cause failure of machine or electric shock.

 **Always install circuit breaker and a dedicated power circuit.**

● Incorrect installation may cause fire and electric shock.

 **Always unplug the unit if strange sounds, smell or smoke comes from the unit.**

● Failure to do so may cause fire and electric shock.

 **Do not use the socket if it is loose or damaged.**

● Doing so may cause fire and electric shock.

 **Do not open the unit during operation.**

● Doing so may cause electric shock.

 **Do not use firearms near unit.**

● Doing so may cause fire.

 **Do not use the power cord close to heating appliances.**

● Doing so may cause fire and electric shock.

 **Do not disassemble, modify, or drill holes into the air conditioner.**

● Doing so may cause failure and electric shock.

 **Ventilate room before operating air conditioner if there is a gas leakage from another appliance such as a stove.**

● Failure to do so may cause explosion, fire and burns.

 **Do not use the power cord near flammable gas or combustibles, such as gasoline, benzene, thinner, etc.**

● Doing so may cause an explosion or fire.



CAUTION

⊘ When removing air filter, do not touch metal parts of the unit.

- Doing so may cause an injury.

⊘ Do not clean with water.

- Water may enter the unit and degrade the insulation causing an electric shock.

⚠ Ensure proper ventilation especially in rooms with a stove or other appliances.

- Failure to do so may result in an oxygen shortage.

⚠ Unit and Circuit breaker/fuse must be switched OFF when cleaning.

- Cleaning unit when power is ON may cause fire and electric shock and may cause an injury.

⊘ Do not put a pet or house plant where it will be exposed to direct air flow.

- This could injure the pet or plant.

⚠ Use only as intended.

- This unit is NOT intended to preserve precision devices, food, pets, plants, and art objects. It may cause deterioration of quality, etc.

⚠ Stop operation and close the window in severe storms or hurricanes.

- Operation with windows open may cause moisture to enter the room.

⚠ Hold the plug by the head of the power plug when taking it out.

- Failure to do so may cause electric shock and damage.

⚠ If unit will not be used for a long period of time, turn OFF main power switch.

- Leaving power on may cause unit failure or fire.

⊘ Do not place obstacles around air-inlets or inside of air-outlet.

- Obstacles may cause appliance failure or accident.

⚠ Periodically check installation bracket for damage.

- Prolonged exposure to outdoor elements may cause damage to installation bracket causing unit to fall.

⚠ Always insert the filters securely. Clean filter AT LEAST once every two weeks.

- Operation without secured filters may cause failure. A dirty filter can cause the unit to not run efficiently.

⚠ Use only a soft cloth to clean the unit.

- Cleaners or detergents may change the color or scratch the surface of the unit.

⚠ Use caution when unpacking and installing.

- Sharp edges could cause injury.

⊘ NEVER drink water drained from air conditioner.

- Water from unit contains contaminants and could cause illness.

⊘ Do not place heavy objects on the power cord and always ensure that the cord is not compressed.

- There is danger of fire or electric shock.

⚠ If water enters the unit, turn the unit off at the power outlet and switch off the circuit breaker. Isolate supply by taking the power-plug out and contact a qualified serviced technician.

- There is danger of electric shock.

IMPORTANT SAFETY INSTRUCTIONS

NOTE The power supply cord with this air conditioner contains a current detection device designed to reduce the risk of fire. Please refer to the section "Operation of Current Device" (below) for details. In the event that the power supply cord is damaged, it **MUST** be replaced by a qualified service technician.

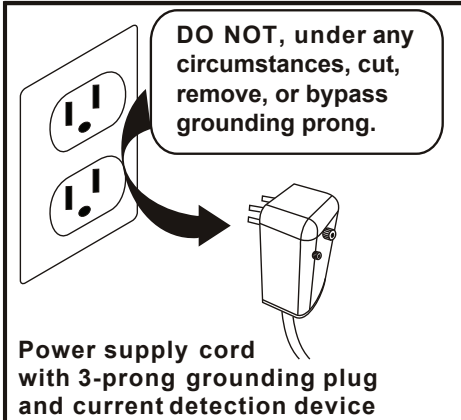

▲WARNING! For Your Safety

- DO NOT store or use gasoline or other flammable vapors or liquids in the vicinity of this or any other appliance.
- Avoid fire hazard or electric shock. DO NOT use an extension cord or an adaptor plug. DO NOT remove any prong from the power cord.

▲WARNING! Electrical Information

- Be sure the electrical service is adequate for the model you have chosen. This information can be found on the serial plate, which is located on the side of the cabinet and behind the grille.
- Be sure the air conditioner is properly grounded. To minimize shock and fire hazards, proper grounding is important. The power cord is equipped with a three-prong grounding plug for protection against shock hazards.
- Your air conditioner must be used in a properly grounded wall receptacle. If the wall receptacle you intend to use is not adequately grounded or protected by a time delay fuse or circuit breaker, have a qualified electrician install the proper receptacle.
- Ensure the receptacle is accessible after the unit installation.
- Do not run air conditioner without side protective cover in place. This could result in mechanical damage within the air conditioner.
- **Do not use an extension cord or an adaptor plug.**

▲WARNING! Prevent Accidents

To reduce the risk of fire, electrical shock, or injury to persons when using your air conditioner, follow basic precautions, including the following:

- If the air conditioner is to be installed in a window, you will probably want to clean both sides of the glass first. If the window is a triple-track type with a screen panel included, remove the screen completely before installation.
- Be sure the air conditioner has been securely and correctly installed according to the installation instructions in this manual. Save this manual for possible future use in removing or installing this unit.
- When handling the air conditioner, be careful to avoid cuts from sharp metal fins on front and rear coils.

Operation of Current Device

The power supply cord contains a current device that senses damage to the power cord. To test your power supply cord do the following:

1. Plug in the air conditioner.
2. The power supply cord will have TWO buttons on the plug head. Press the TEST button. The RESET button will click as it pops out.
3. Press the RESET button; again you will notice a click as the button engages.
4. The power supply cord is now supplying electricity to the unit.
(On some products this is also indicated by a light on the plug head.)

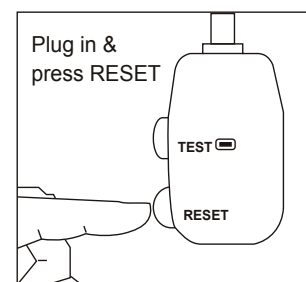

NOTE: Some plugs have buttons on the top.

- NOTES:**
- Do not use this device to turn the unit on or off.
 - Always make sure the RESET button is pushed in for correct operation.
 - The power supply must be replaced if it fails to reset when either the TEST button is pushed or it cannot be reset.
 - If power supply cord is damaged, it cannot be repaired. Please call customer service to assist with replacement.

NOTE: This air conditioner is designed to be operated under conditions as follows:

Cooling operation	Outdoor temp:	18-43°C/64-109°F (18-52°C/64-125°F for special tropical models)
	Indoor temp:	17-32°C/62-90°F
Heating operation	Outdoor temp:	-5-24°C/23-76°F
	Indoor temp:	0-27°C/32-80°F

*NOTE: Not all units come with heating capabilities. The "Heating operation" specifications only apply for units that DO have a heating element. If the unit is operated beyond the conditions specified above, it may cause a failure of the unit.

NORMAL SOUNDS

Sound of Rushing Air
At the front of the unit you may hear the sound of rushing air being moved by the fan.

Gurgle/Hiss
“Gurgling” or “Hissing” noise may be heard due to refrigerant passing through evaporator during normal operation.

High Pitched Chatter
High efficiency compressors may have high pitched chatter during the cooling cycle.

Vibration
Unit may vibrate and make noise because of poor wall or window construction or incorrect installation.

Pinging or Switching
Droplets of water hitting condenser during normal operation may cause “pinging” or “switching” sounds.

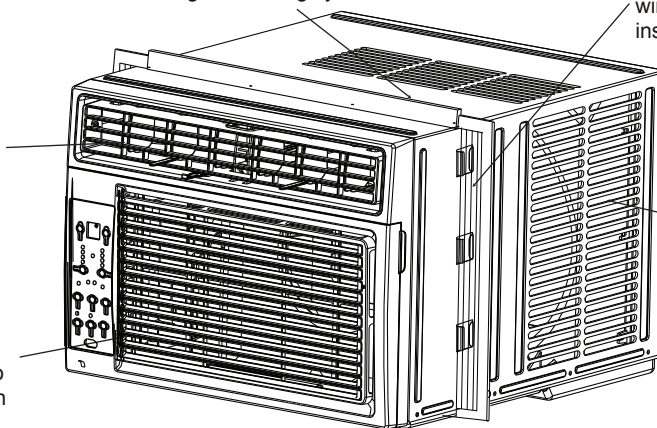

AIR CONDITIONER FEATURES

ELECTRONIC CONTROL OPERATING INSTRUCTIONS

Before you begin, thoroughly familiarize yourself with the control panel as shown to the right and all its functions. Then, follow the symbol for the functions you desire. The unit can be controlled by the unit controls alone or with the remote control.

NOTE: This illustration is for explanation purposes only. The actual appearance of the control panel on the air conditioner purchased may be slightly different.

NOTE: References to Heating (“HEAT”) in this manual are applicable only to units that have a built in electric heater for supplemental heating. “HEAT” is not applicable to cooling only models.

Remote signal receptor

UNIT CONTROLS

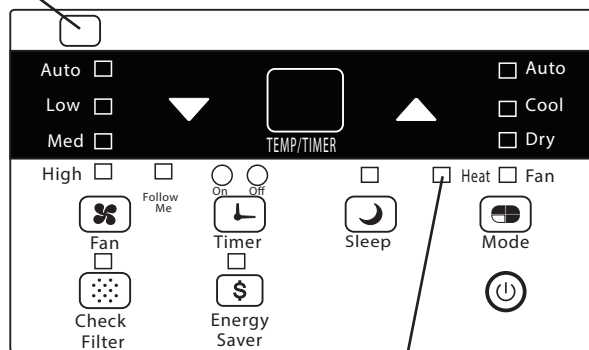

Heat indicator is only on units that possess heating capabilities.

TO TURN UNIT ON OR OFF:

Press **ON/OFF** button to turn the unit on or off.

NOTE: The unit will automatically initiate the Energy Saver function under “Cool,” “Dry,” and “Auto” (only Auto-Cooling and Auto-Fan) modes.

TO CHANGE TEMPERATURE SETTING:

Press **UP/DOWN** button to change the temperature setting.

NOTE: Press or hold either UP (▲) or DOWN (▼) button until the desired temperature is seen on the display. This temperature will be automatically maintained anywhere between 62°F (17°C) and 86°F (30°C). If you want the display to read the actual room temperature, see “To Operate on Fan Only” section on the next page.

AIR CONDITIONER FEATURES (CONTINUED)

TO ADJUST THE FAN SPEED:

Press  to select one of four fan speeds: "Auto," "Low," "Med" or "High." Each time the button is pressed, the fan speed mode is shifted. On "Dry" mode the fan speed is set at low automatically. For some models with heating capabilities, the fan speed cannot be adjusted under "Heat" mode.

SLEEP FEATURE:

Press  Sleep button to initiate the sleep mode. In this mode the selected temperature will increase (cooling) or decrease (units with heating only) by 2°F/1°C 30 minutes after the mode is selected. The temperature will then increase (cooling) or decrease (units with heating only) by another 2°F/1°C after an additional 30 minutes. This new temperature will be maintained for 6 hours before it returns to the originally selected temperature. This ends the Sleep mode and the unit will continue to operate as originally programmed. The Sleep mode program can be cancelled at any time during operation by pressing the "Sleep" button again.

CHECK FILTER FEATURE:

Press  Check Filter button to initiate this feature. This feature is a reminder to clean the Air Filter for more efficient operation. The LED (light) will illuminate after 250 hours of operation. To reset after cleaning the filter, press the "Check Filter" button and the light will go off.

ENERGY SAVER FEATURE:

Press  Energy Saver button to initiate this function. This function is available on "Cool," "Dry," and "Auto" (only Auto-Cooling and Auto-Fan) modes. In this mode, the fan will continue to run for 3 minutes after the compressor shuts off. The fan then cycles on for 2 minutes, at 10 minute intervals, until the room temperature is above the set temperature, at which time the compressor turns back on and cooling starts.

FOLLOW ME FEATURE:

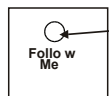

Light flashing

This feature can ONLY be activated from the remote control. The remote control serves as a remote thermostat allowing for precise temperature control at its location.

To activate the Follow Me feature, point the remote control towards the unit and press the "Follow Me" button. The remote displays the actual temperature at its location. The remote control will send this signal to the air conditioner every 3 minutes until the Follow Me button is pressed again. If the unit does not receive the Follow Me signal during any 7 minute interval, the unit will beep to indicate the Follow Me mode has ended. The actual temperature can be displayed at the unit by pressing the "Fan" only mode. When in the "Cool" mode, the unit display indicates the set temperature.

TO SELECT THE OPERATING MODE:

To choose operating mode, press the  Mode button. Each time you press the button, a mode is selected in a sequence that goes from "Auto" - "Cool" - "Dry" - "Heat" - (for units with heating function) and "Fan." The indicator light will be illuminated and remain on once the mode is selected. **The unit will automatically initiate the Energy Saver function under "Cool," "Dry," and "Auto" (only Auto-Cooling and Auto-Fan) modes.**

To operate on "Auto" feature:

When you set the air conditioner in AUTO mode, it will automatically select cooling, heating (on models with heating capabilities), or fan only operation depending on what temperature you have selected and the room temperature. The air conditioner will control room temperature automatically around the temperature you set. **In this mode, the fan speed cannot be adjusted.** It starts automatically at a speed according to the room temperature.

To operate on "Fan" only:

Use this function only when cooling is not desired, such as for room air circulation or to exhaust stale air. (Remember to open the vent during this function, but keep it closed during cooling for maximum cooling efficiency.) You can choose any fan speed you prefer. During this function, the display will show the actual room temperature, not the set temperature as in the cooling mode.

To operate on "Dry" mode:

In this mode, the air conditioner will reduce air humidity. The fan will automatically switch to LOW speed. Fan speed cannot be changed in Dry mode. If the space is a closed or sealed area, some degree of cooling will continue.

TIMER: AUTO START/STOP FEATURE:

- When the unit is on or off, first press  Timer button. The TIMER ON indicator light illuminates. It indicates the Auto Start program is initiated.
- When the time of TIMER ON is displayed, if you press the Timer button again, the TIMER OFF indicator light illuminates. It indicates the Auto Stop program is initiated.
- Press or hold the UP or DOWN button to change the Auto time by 0.5 hour increments, up to 10 hours, then by 1 hour increments, up to 24 hours. The control will count down the time remaining until start.
- The selected time will register in 5 seconds and the system will automatically revert back to display the previous temperature setting or the room temperature (depending on whether the unit is powered on or off and the mode it is in).
- Turning the unit ON or OFF at any time or adjusting the timer setting to 0.0 will cancel the Auto Start/ Stop program.

AIR CONDITIONER FEATURES (CONTINUED)

DISPLAYS

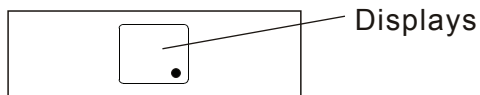

NOTE: If the unit breaks off unexpectedly due to power being cut, it will automatically restart with the previous function setting when the power resumes.

Shows the set temperature in “°C” or “°F” and the Auto-timer settings. While on “Fan” only mode, it shows the room temperature.

Error Codes:

AS - Room temperature sensor error - Unplug the unit and plug it back in. If error repeats, call customer service.

NOTE: If error occurs in “Fan” only mode, unit will display “LO” (loose connection) or “HI” (short circuit).

HS - Electric heating sensor error - Unplug the unit and plug it back in. If error repeats, call customer service.

• - **Evaporator temperature sensor error** - Unplug the unit and plug it back in. If error repeats, call customer service. (“•” is displayed as shown in left picture.)

ADDITIONAL THINGS YOU SHOULD KNOW

- The Cool circuit has an automatic 3 minute time-delayed start if the unit is turned off and on quickly. After the unit is turned off, leave unit off for a minimum of 3 minutes before attempting to turn back on. This prevents overheating of the compressor and possible circuit breaker tripping. The fan will continue to run during this time.
- The control is capable of displaying temperature in degrees Fahrenheit or degrees Celsius. To convert from one to the other, press and hold the Up and Down Temp/Timer buttons at the same time, for 3 seconds.

Air Directional Louvers

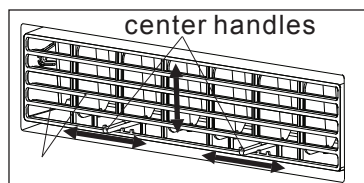

Air Direction (4- way)

HOW TO USE:

Use the 4-way directional louvers to direct the air flow flow up or down and left or right throughout the room as needed.

Pivot horizontal louvers until the desired up/down direction is obtained.

Move the center handles from side to side until the desired left/right direction is obtained.

There are a total of 4 possible air directional orientations available with this system.

INSTALLATION INSTRUCTIONS

DO THIS FIRST

(for existing sleeve)

Note that the air conditioner dimensions are: 24.25 inches wide, 14.5 inches, and 18.5 inches deep (without front).

Install air conditioner according to these installation instructions to achieve the best performance. Save these installation instructions for future reference.

NOTE: Do not use any screws other than those specified in these instructions.

CAUTION

Do not, under any circumstances, cut or remove the third (ground) prong from the power cord.

Do not change the plug on the power cord of the air conditioner.

Aluminum house wiring may present special problems- consult a qualified electrician.

When handling unit, be careful to avoid cuts from sharp metal edges and aluminum fins on front and rear coils.



BEFORE YOU BEGIN

Read these instructions completely and carefully.

IMPORTANT- Save these instructions.

IMPORTANT- Observe all governing codes and ordinances.

Note to Installer- Be sure to leave these instructions with the Consumer.

Note to Consumer- Keep these instructions for future reference.

Skill level- Installation of this appliance requires basic mechanical skills.

Completion time- Approximately 1 hour.

We recommend that two people install this product.

Proper installation is the responsibility of the installer.

Product failure due to improper installation is not covered under the Warranty.

You **MUST** use all supplied parts and use proper installation procedures as described in these instructions when installing this air conditioner.

Items in Kit

You may not need all parts in the kit. Discard unused parts.

Item	Dimensions (if applicable)	Quantity
Tapered Spacer Blocks	17" Long	2
Centering/Support Blocks	4 1/2" x 3 1/2" x 1 1/2"	4
Plastic Divider	1/8" x 4 1/2" x 14 1/2"	2
Stuffer Seal	1" x 1 1/2" x 84"	1
Seal	1" x 1 1/2" x 25"	3
Seal	1" x 1 1/2" x 14"	2
Seal	1" x 3/8" x 25"	3
Seal	1" x 3/8" x 14"	2
Seal	1" x 3/4" x 14"	2
Trim Frame (side legs)		2
Trim Frame (top & bottom legs)		2
Ground Wire (green)		1
Toothed washer for grounding screw		2
Grounding Screw		1
Grille (plastic)		1
Grille (aluminium)		1
Nuts (plastic)		4
Screw Washer		4
Screw		4

INSTALLATION INSTRUCTIONS (CONTINUED)

How to Install

1. Identify the wall-sleeve brand for your installation, from the chart below.

Wall Sleeve Dimensions

Brand	Width	Height	Depth
Perfect Aire, Frigidaire, White-Westinghouse, Carrier (52F Series)	25 1/2"	15 1/4"	16", 17 1/2" or 22"
General Electric, Hotpoint	26"	15 5/8"	15 7/8"
Whirlpool	25 7/8"	16 1/2"	17 1/8" or 23"
Fedders, Emerson	27"	16 3/4"	16 3/4" or 19 3/4"
Sears/Kenmore, Carrier (51S Series)	25 3/4"	16 7/8"	18 5/8"
Fedders, Emerson	26 3/4"	15 3/4"	15"
Friedrich	27"	16 3/4"	16 3/4"

Note:

Please verify dimensions of your wall sleeve with its manufacturer before installing your thru-the-wall unit.

Note: All wall sleeves used to mount the new air conditioner must be in sound structural condition and have a rear grille that securely attaches to sleeve, or rear flange that serves as a stop for the air conditioner.

Caution: When installation is complete, replacement unit **MUST** have a rearward slope as shown.

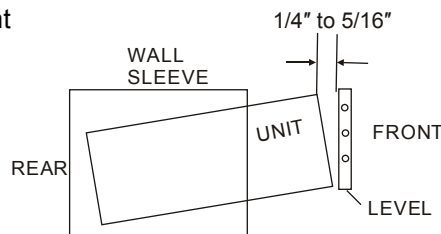

2. Remove old air conditioner from wall sleeve and prepare wall sleeve as follows:

- Clean interior. (Do not disturb seals.)
- Wall sleeve must be securely fastened in wall before installing air conditioner. Drive more nails or screws through sleeve, into wall, if needed.
- Repair paint if needed.

3. If not existing, drill a 1/8" clearance hole for grounding screw through left side of sleeve, in a clear area about 3 inches maximum (to suit) back from front edge of sleeve (as shown on right) using grounding screw and toothed washer. Pull loose end of ground wire out front of sleeve, and temporarily bend it down and around lower edge of sleeve. The ground wire will be attached to frame of air conditioner later once it is installed.

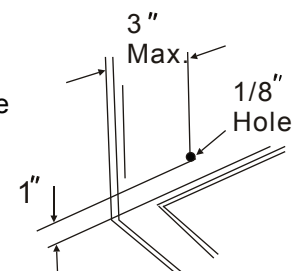

INSTALLATION INSTRUCTIONS (CONTINUED)

4. Prepare the wall sleeve for installation of the new unit per the following brand instructions:

	Brand	Depth	Refer to Page
#1	Emerson	15" deep	11
#2	Fedders	19 3/4" deep	12
#3	Fedders or Friedrich	16 3/4" deep	13
#4	General Electric/Hotpoint	16 7/8" deep	14
#5	Sears or Carrier (51S Series)	18 5/8" deep	15
#6	Whirlpool	17 1/8" deep	16
#7	Whirlpool	23" deep	17
#8	Perfect Aire , Frigidaire White-Westinghouse, Carrier (52F Series)	16" & 17 1/2" deep	18
#9	White-Westinghouse, Frigidaire	22" deep	19

5. Identify your wall sleeve's brand and install new unit into wall sleeve using the applicable instructions on the following pages.

6. To attach ground wire to the new unit, remove the screw from the left side front.

7. Assemble and install the Trim Frame (see instructions).

IMPORTANT

- The unit's increased performance characteristics result from having two rear air intakes.
- It is very important that these installation instructions are followed to ensure that your unit can operate at maximum efficiency.
- If this is an existing sleeve, and there is an existing rear grille, it needs to be replaced by one that has been shipped with the unit in the accessory kit.

For increased efficiency, utilize the provided louvered rear panel.

Installation of new grille provided with unit:

1. Remove the existing grille.
2. Place the grille included with the new air conditioner towards the rear of the sleeve.
3. Mark the hole positions.
4. Drill through the sleeve's flanges with a 1/8" drill bit.
5. Attach the new grille with self-threading screws and washers (not included).
6. It is VERY IMPORTANT that the grille is placed exactly as shown in the picture on the right.
7. Most decorative exterior grilles may be left in place as long as the proper interior air direction grille is installed.

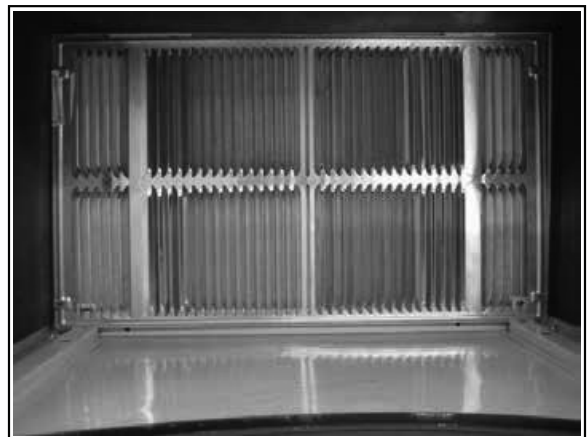

INSTALLATION INSTRUCTIONS (CONTINUED)

Wall Sleeve Brands:

#1 Emerson • 15" Deep

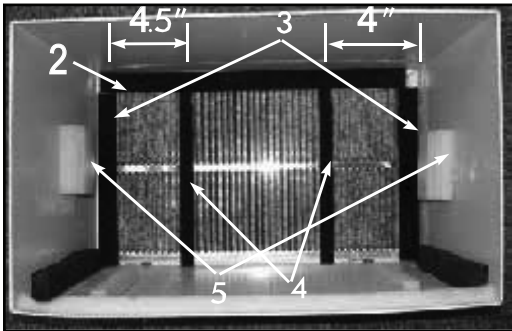
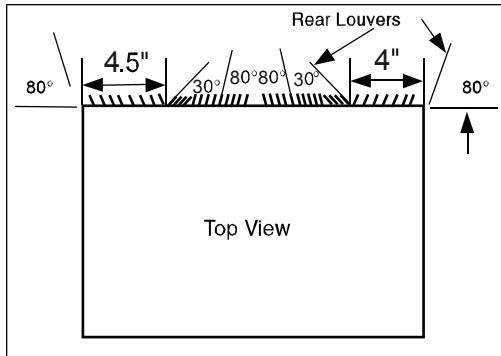

1. Remove existing rear grille as shown on page 11 of this manual and replace with provided louvered panel. Install as shown here.

Note: You may need to drill holes in flange of existing sleeve to match new rear grille.

2. Attach (1) 1" x 3/8" x 25" long seal in the center at the top of the sleeve. Remove the backing paper and press into position.

3. Attach the (2) 1" x 3/8" x 14" long seals to the left and right sides of the sleeve.

4. Cut (2) 1" x 3/8" x 25" long seals to 14" long and attach to the vertical sections of the rear grille as shown.

5. Attach (2) 4 1/2" x 3 1/2" x 1 1/2" centering/support blocks, one on each side wall. Place in center of side wall with the tapered end facing the opening.

6. Gently slide unit into sleeve.

7. Before sliding all the way back, remove 2nd screw from front on left side of unit.

8. Remove the plastic washer from the screw.

9. Screw and attach the other end of the ground wire to the unit as shown in picture. Make sure that the toothed washer is against the cabinet.

10. Slide the unit completely to the rear to ensure a good seal, making sure the ground wire does not become tangled.

11. Seal & frame the unit as described on page 21.

12. If you have difficulty with mounting the grille to the sleeve, follow the instructions for direct mounting on page 20.

INSTALLATION INSTRUCTIONS (CONTINUED)

Wall Sleeve Brands:

#2 Fedders • 19³/₄" Deep

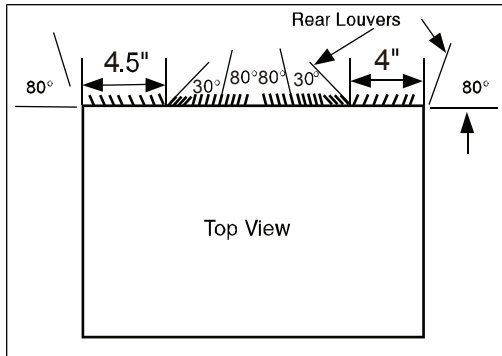

1. Remove existing rear grille as shown on page 11 of this manual and replace with provided louvered panel. Install as shown here.

Note: You may need to drill holes in flange of existing sleeve to match new rear grille.

2. Attach (2) 4¹/₂" x 3¹/₂" x 1¹/₂" centering/support blocks, one on each side wall. Place in center of side walls with the tapered end facing the opening.

3. Cut the (2) 17" Tapered Spacer Blocks as shown below into two pieces.

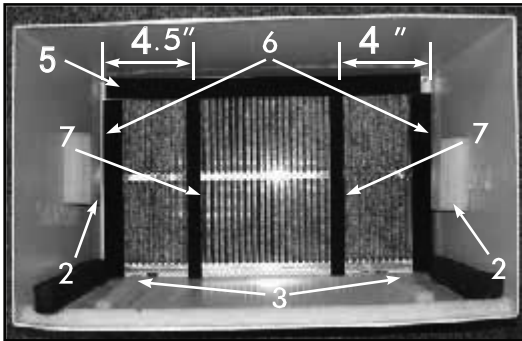
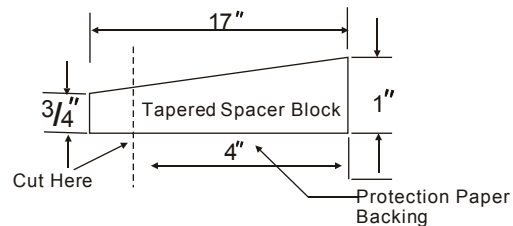

4. The 4" section is placed in front of the rib on base with the tapered end facing the back of the sleeve. The remaining portion behind the rib again is sloping toward the rear of the sleeve. This helps induce a rearward slope on the unit.

5. Attach (1) 1" x 3/8" x 25" long seal in the center at the top of the sleeve. Remove the backing paper and press into position.

6. Attach (2) 1" x 3/8" x 14" long seals to the left and right sides of the sleeve.

7. Cut (2) 1" x 3/8" x 25" long seal to 14" long and attach it to the vertical sections of the rear grille as shown.

8. Gently slide unit into sleeve.

9. Before sliding all of the way back, remove 2nd screw from front on left side of the unit.

10. Remove the plastic washer from the screw.

11. Screw and attach the other end of the ground wire to the unit as shown in picture. Make sure that the toothed washer is against the cabinet.

12. Slide the unit completely to the rear to ensure a good seal, making sure the ground wire does not become tangled.

13. Seal & frame the unit as described on page 21.

14. If you have difficulty with mounting the grille to the sleeve, follow the instructions for direct mounting on page 20.



INSTALLATION INSTRUCTIONS (CONTINUED)

Wall Sleeve Brands:

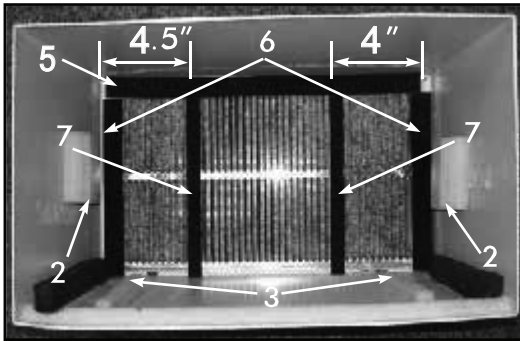
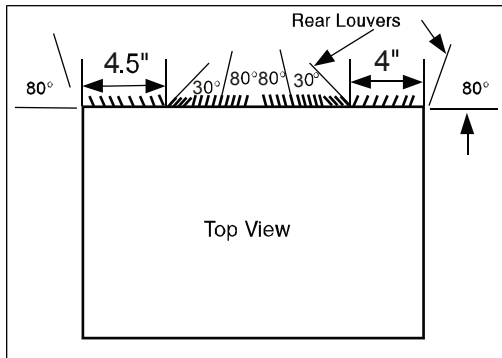

#3 Fedders or Friedrich • 16³/₄" Deep

1. Remove existing rear grille as shown on page 11 of this manual and replace with provided louvered panel. Install as shown here.

Note: You may need to drill holes in flange of existing sleeve to match new rear grille.

2. Attach (2) 4¹/₂" x 3¹/₂" x 1¹/₂" centering/support blocks, one on each side wall. Place in center of side walls with the tapered end facing the opening.

3. Cut (2) 17" Tapered Spacer Blocks as shown below into three pieces.

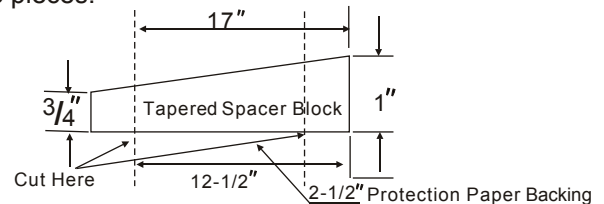

4. The 2¹/₂" section is placed in front of the rib on base with the tapered end facing the back of the sleeve. Cut the remaining portion to 12¹/₂" and place behind the rib again, sloping toward the rear of the sleeve. This helps to induce a rearward slope on the unit.

5. Attach (1) 1" x 3/8" x 25" long seal in the center at the top of the sleeve. Remove backing paper and press into position.

6. Attach (2) 1" x 3/8" x 14" seals to the left and right sides of the sleeve.

7. Cut (2) 1" x 3/8" x 25" long seals to 14" long and attach to the vertical sections of the rear grille as shown.

8. Gently slide unit into sleeve.

9. Before sliding all of the way back, remove 2nd screw from front on left side of unit.

10. Remove the plastic washer from the screw.

11. Screw and attach the other end of the ground wire to the unit as shown in picture. Make sure that the toothed washer is against the cabinet.

12. Slide the unit completely to the rear to ensure a good seal, making sure the ground wire does not become tangled.

13. Seal & frame the unit as described on page 21.

14. If you have difficulty with mounting the grille to the sleeve follow the instructions for direct mounting on page 20.

INSTALLATION INSTRUCTIONS (CONTINUED)

Wall Sleeve Brands:

#4 General Electric or Hotpoint • 16 7/8" Deep

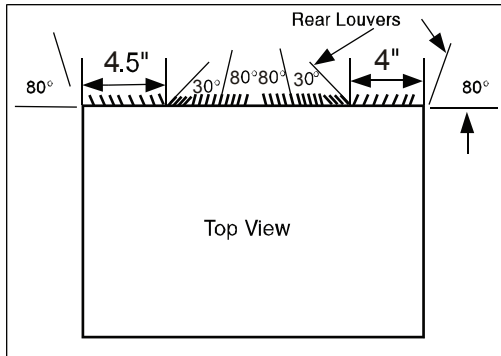

1. Remove existing rear grille as shown on page 11 of this manual and replace with provided louvered panel. Install as shown here.

Note: You may need to drill holes in flange of existing sleeve to match new rear grille.

2. Cut (2) 17" Tapered Spacer Blocks as shown below into two pieces.

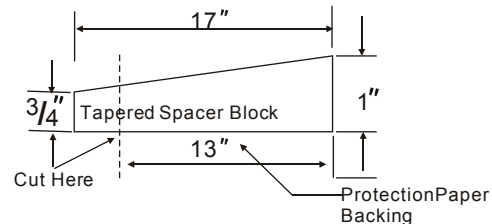

3. Install 13" section as shown with the tapered end 1/2" from the back of the sleeve. This helps induce a rearward slope on the unit.

4. Attach (1) 1" x 3/8" x 25" long seal in the center at the top of the sleeve. Remove backing paper and press into position.

5. Attach (2) 1" x 3/8" x 14" seals to the left and right sides of the sleeve.

6. Cut (2) 1" x 3/8" x 25" long seals to 14" long and attach to the vertical sections of the rear grille as shown.

7. Center unit and gently slide unit into sleeve.

8. Before sliding all of the way back, remove 2nd screw from front on left side of unit.

9. Remove the plastic washer from the screw.

10. Screw and attach the other end of the ground wire to the unit as shown in picture. Make sure that the toothed washer is against the cabinet.

11. Slide the unit completely to the rear to ensure a good seal, making sure the ground wire does not become tangled.

12. Seal & frame the unit as described on page 21.

13. If you have difficulty with mounting the grille to the sleeve follow the instructions for direct mounting on page 20.

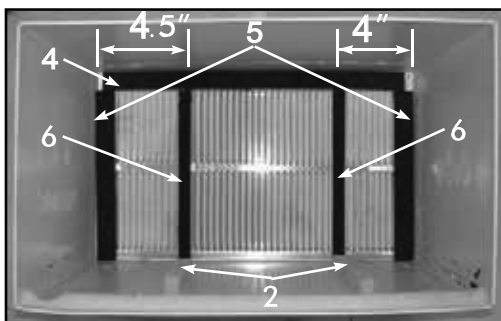

INSTALLATION INSTRUCTIONS (CONTINUED)

Wall Sleeve Brands:

#5 Sears or Carrier 51S Series • 18 5/8" Deep

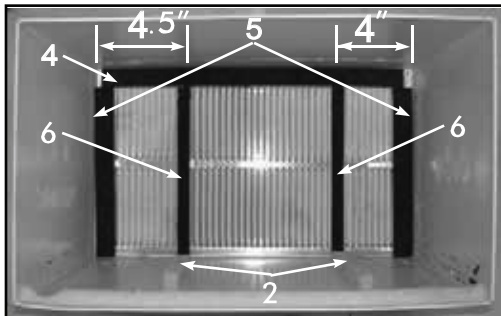
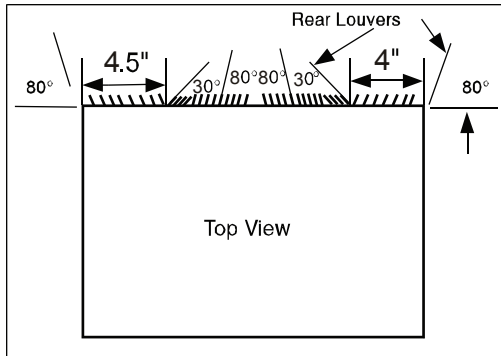

1. Remove existing rear grille as shown on page 11 of this manual and replace with provided louvered panel. Install as shown here.

Note: You may need to drill holes in flange of existing sleeve to match new rear grille.

2. Install (2) tapered spacer blocks to the floor of the sleeve as shown. DO NOT CUT THE BLOCKS. This helps induce a rearward slope on the unit.

3. Install as shown with the tapered end 1/2" from the back of the sleeve. This helps induce a rearward slope on the unit.

4. Attach (1) 1" x 3/8" x 25" long seal in the center at the top of the sleeve. Remove backing paper and press into position.

5. Attach (2) 1" x 3/8" x 14" seals to the left and right sides of the sleeve.

6. Cut (2) 1" x 3/8" x 25" long seals to 14" long and attach to the vertical sections of the rear grille as shown.

7. Center unit and gently slide unit into sleeve.

8. Before sliding all of the way back, remove 2nd screw from front on left side of unit.

9. Remove the plastic washer from the screw.

10. Screw and attach the other end of the ground wire to the unit as shown in picture. Make sure that the toothed washer is against the cabinet.

11. Slide the unit completely to the rear to ensure a good seal, making sure the ground wire does not become tangled.

12. Seal & frame the unit as described on page 21.

13. If you have difficulty with mounting the grille to the sleeve follow the instructions for direct mounting on page 20.

INSTALLATION INSTRUCTIONS (CONTINUED)

Wall Sleeve Brands:

#6 Whirlpool • 17 1/8" Deep

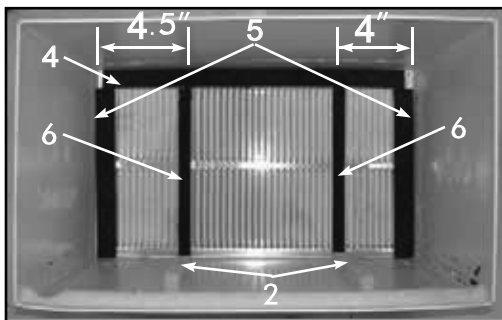
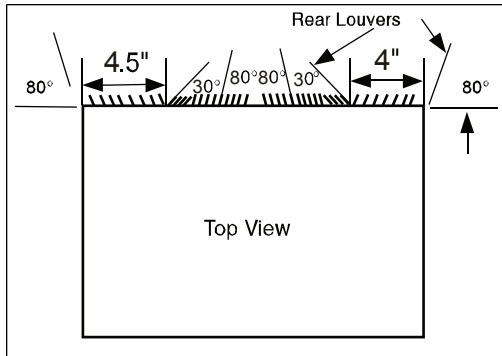

1. Remove existing rear grille as shown on page 11 of this manual and replace with provided louvered panel. Install as shown here.

Note: You may need to drill holes in flange of existing sleeve to match new rear grille.

2. Cut (2) 17" Tapered Spacer Blocks as shown below into two pieces.

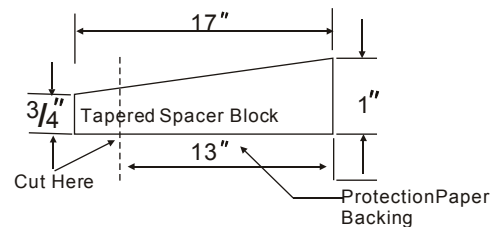

3. Install 13" section to the floor of the sleeve as shown. This helps induce a rearward slope on the unit.

4. Attach (1) 1" x 3/8" x 25" long seal in the center at the top of the sleeve. Remove backing paper and press into position.

5. Attach (2) 1" x 3/8" x 14" seals to the left and right sides of the sleeve.

6. Cut (2) 1" x 3/8" x 25" long seals to 14" long and attach to the vertical sections of the rear grille as shown.

7. Center unit and gently slide unit into sleeve.

8. Before sliding all of the way back, remove 2nd screw from front on left side of unit.

9. Remove the plastic washer from the screw.

10. Screw and attach the other end of the ground wire to the unit as shown in picture. Make sure that the toothed washer is against the cabinet.

11. Slide the unit completely to the rear to ensure a good seal, making sure the ground wire does not become tangled.

12. Seal & frame the unit as described on page 21.

13. If you have difficulty with mounting the grille to the sleeve follow the instructions for direct mounting on page 20.

INSTALLATION INSTRUCTIONS (CONTINUED)

Wall Sleeve Brands:

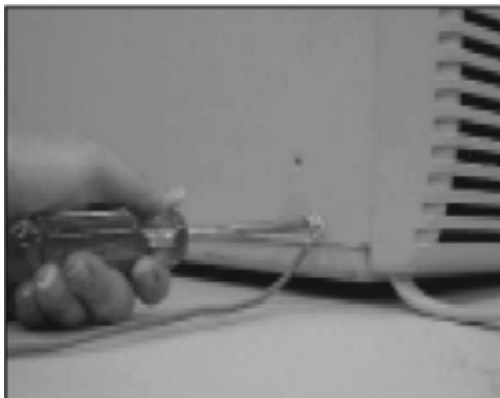
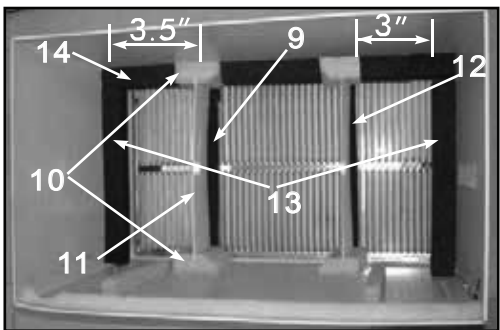
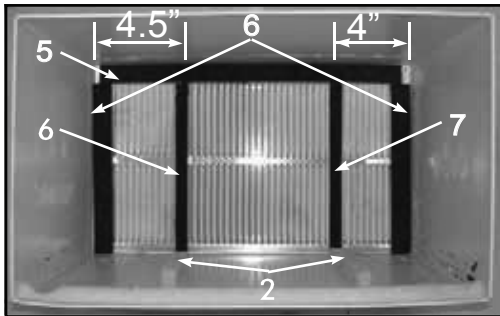
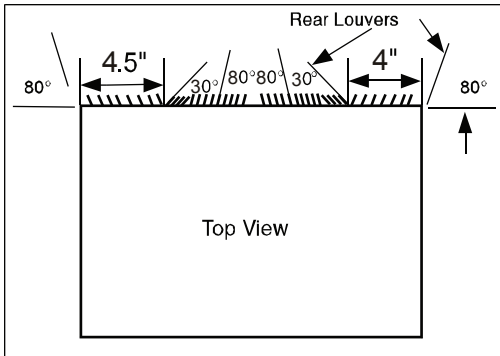

#7 Whirlpool • 23" Deep

1. Remove existing rear grille as shown on page 11 of this manual and replace with provided louvered panel. Install as shown here.

Note: You may need to drill holes in flange of existing sleeve to match new rear grille.

Because of the increased unit depth, first try dry fitting using methods described below:

2. Place (2) 1" x 1½" x 14" seals against each side.
3. Gently slide unit in and check if amount extending from the sleeve is sufficient once the trim frame is attached.
4. If position is OK, remove unit and proceed to the next step. If not, go to step 9.
5. Attach (1) 1" x 1½" x 25" long seal in the center at the top of the sleeve. Remove the backing paper and press into position.
6. Attach (2) 1" x 1½" x 14" seals to the left and right sides of the sleeve.
7. Cut (2) 1" x ¾" x 25" long seals to 14" long and attach to the vertical sections of the grille as shown.
8. Attach the tapered spacer blocks to the floor of the sleeve. Now go to step 15.

Use these next steps if the unit requires extra extension into the room.

9. Attach 1" x ¾" x 14" long seal over the solid vertical portion of the rear grille.
10. Attach (2) 4½" x 3½" x 1½" foam blocks with the slot overlapping the seal above.
11. Install the divider into the slots of the foam blocks. You may need to trim the length to size.
12. Repeat steps 9 through 11 for the other vertical shown portion of the grille as shown.
13. Attach (2) 1" x 1½" x 14" seals along the sides of the sleeve again making sure all seals are flush.
14. Cut the 1" x 1½" x 25" seal to fit the top of the sleeve. The pieces must be fitted flush to the edge of the divider.
15. Center unit and gently slide in sleeve.
16. Before sliding all the way back, remove first screw from front on left side of unit.
17. Remove the plastic washer from the screw.
18. Screw and attach the other end of the ground wire to the unit as shown in picture. Make sure that the toothed washer is against the cabinet.
19. Slide the unit completely to the rear to ensure a good seal, making sure the ground wire does not become tangled.
20. Seal & frame the unit as described on page 21.
21. If you have difficulty with mounting the grille to the sleeve, follow the instructions for direct mounting on page 20.

INSTALLATION INSTRUCTIONS (CONTINUED)

Wall Sleeve Brands:

#8 Perfect Aire, White Westinghouse, Frigidaire, Carrier 52F Series • 16" & 17½" Deep

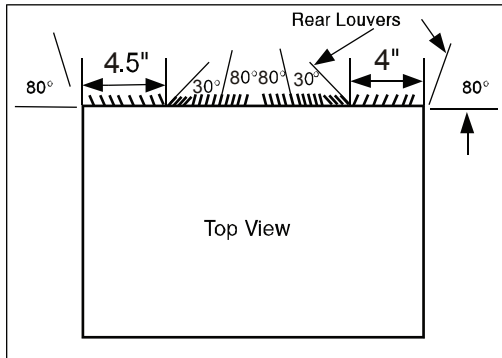

1. Remove existing rear grille as shown on page 11 of this manual and replace with provided louvered panel. Install as shown here.

Note: You may need to drill holes in flange of existing sleeve to match new rear grille.

Because of the increased unit depth, first try dry fitting, using methods described below:

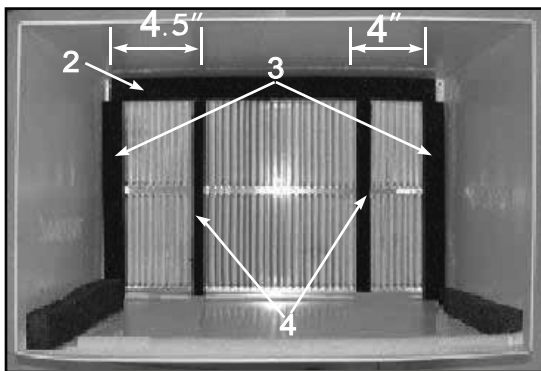

2. Attach (1) 1" x 3/8" x 25" long seal in the center at the top of the sleeve. Remove the backing and press into position.

3. Attach (2) 1" x 3/8" x 14" long seals to the left and right sides of the sleeve.

4. Attach (1) 1" x 3/4" x 14" long seal vertically 4.5" from the left side of the sleeve. Attach the other 1" x 3/4" x 14" long seal 4" from the right side of the sleeve.

5. Center unit and gently slide unit into sleeve.

6. Before sliding all of the way back, remove 2nd screw from front on left side of unit.

7. Remove the plastic washer from the screw.

8. Screw and attach the other end of the ground wire to the unit as shown in picture. Make sure that the toothed washer is against the cabinet.

9. Slide the unit completely to the rear to ensure a good seal, making sure the ground wire does not become tangled.

10. Seal & frame the unit as described on page 21.

11. If you have difficulty with mounting the grille to the sleeve, follow the instructions for direct mounting on page 20.



INSTALLATION INSTRUCTIONS (CONTINUED)

Wall Sleeve Brands:

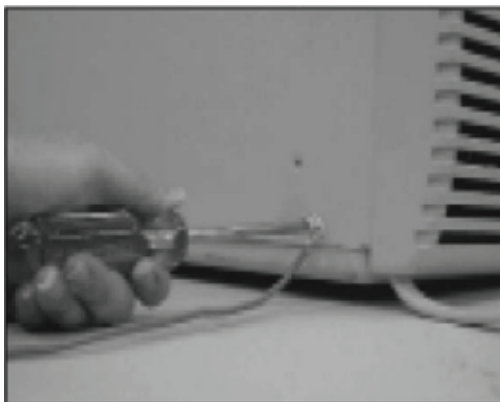
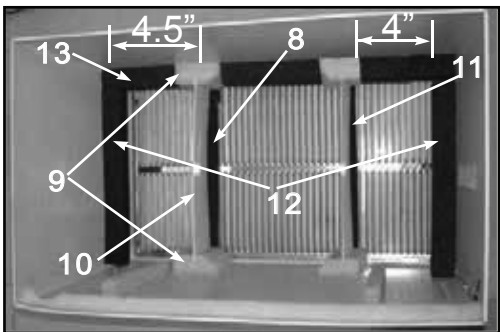
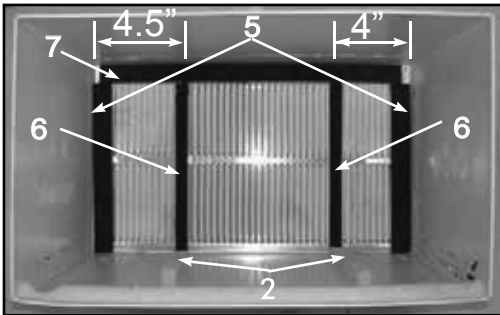
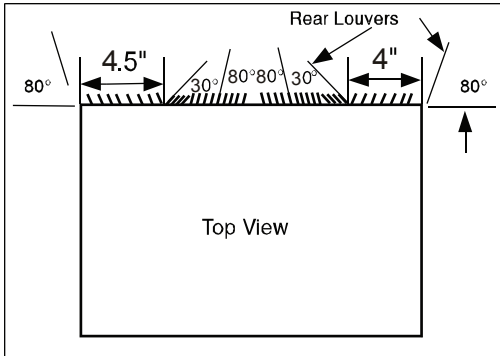

#9 White Westinghouse, Frigidaire • 22" Deep

1. Remove existing rear grille as shown on page 11 of this manual and replace with provided louvered panel. Install as shown here.

Note: You may need to drill holes in flange of existing sleeve to match new rear grille.

Because of the increased unit depth, first try dry fitting, using the method described below:

2. Place (2) 1" x 1½" x 14" seals against each side.
3. Gently slide unit in and check if amount extending from the sleeve is sufficient once the trim frame is attached.
4. If position is OK, remove unit and proceed to the next step. If not, go to step 8.
5. Attach (1) 1" x 1½" x 15" seal to the left side of the sleeve and (1) 1" x 1½" x 15" seal to the right side of the sleeve.
6. Cut (2) 1" x 1½" x 25" long seals to 14" long and attach vertically to the rear grille 4.5" from the left side and 4" from the right side.
7. Attach (1) 1" x 1½" x 25" long seal in the center at the top of the sleeve. Remove the backing paper and press into position. Proceed to step 14.

Use these next steps if the unit requires extra extension into the room.

8. Attach 1" x ¾" x 14" long seal over the solid vertical portion of the rear grille.
9. Attach (2) 4½" x 3½" x 1½" foam blocks with the slot overlapping the seal above.
10. Install the divider into the slots of the foam blocks. You may need to trim the length to size.
11. Repeat steps 8 through 10 for the other vertical portion of the grille as shown.
12. Attach (2) 1" x 1½" x 14" seals along the sides of the sleeve, again making sure all seals are flush.
13. Cut the 1" x 1½" x 25" seal to fit the top of the sleeve. The pieces must be fitted flush to the edge of the divider.
14. Center unit and gently slide unit into sleeve.
15. Before sliding all of the way back, remove first screw from front on left side of unit.
16. Remove the plastic washer from the screw.
17. Screw and attach the other end of the ground wire to the unit as shown in picture. Make sure that the toothed washer is against the cabinet.
18. Slide the unit completely to the rear to ensure a good seal, making sure the ground wire does not become tangled.
19. Seal & frame the unit as described on page 21.
20. If you have difficulty with mounting the grille to the sleeve, follow the instructions for direct mounting on page 20.

INSTALLATION INSTRUCTIONS (CONTINUED)

Direct Unit Mounting

The previous directions are the preferable way to mount the new rear grille. The unit's performance is slightly better and the possibility of drafts is reduced. As a last resort, direct mounting of the grille to the unit can be considered.

Note: The grille must be installed prior to inserting the unit into the sleeve.

1. Attach the 2 seal pieces (1" x 3/8" x 14") as shown in Fig. 1.
2. Position the grille over the rear of the unit making sure that:
 - a. The double set of screw holes are at the bottom.
 - b. The fins of the grille are pointed away from the unit.
3. Align the top of the grille with the top of the unit and ensure that the overhang on each side is equal.
4. If the unit has not been pre-drilled (some models), carefully drill 4-1/8" holes through the grille and into the side flange of the unit approximately 1 1/2" to 2" from the top and bottom as in Fig. 2 and Fig. 3. (Be careful not to drill into copper heat exchanger coils).
5. Install 4- #8 self tapping screws to affix the grille to the unit.
6. Insert the unit into the sleeve.

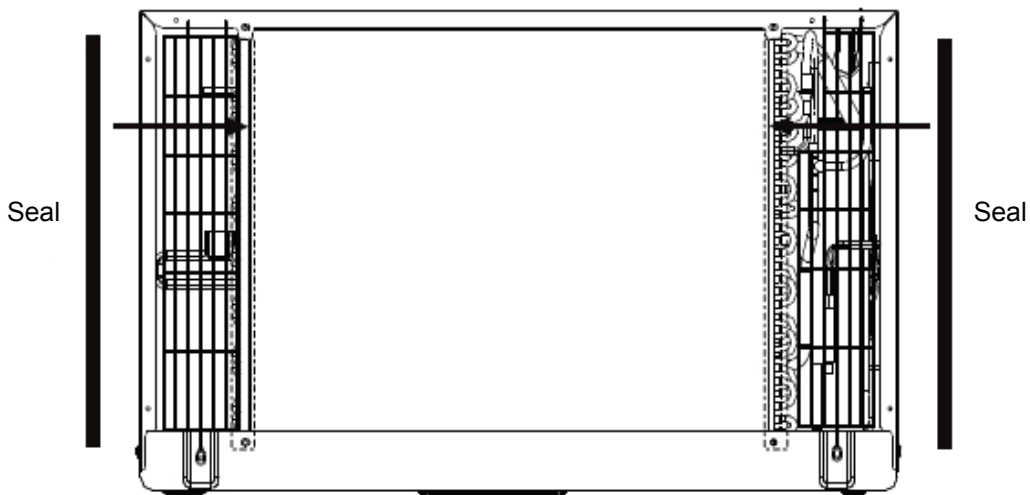

Fig. 1

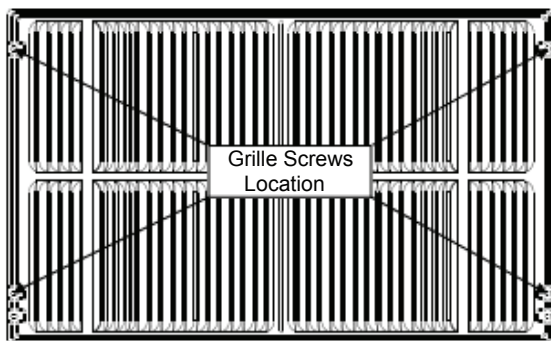

Fig. 2

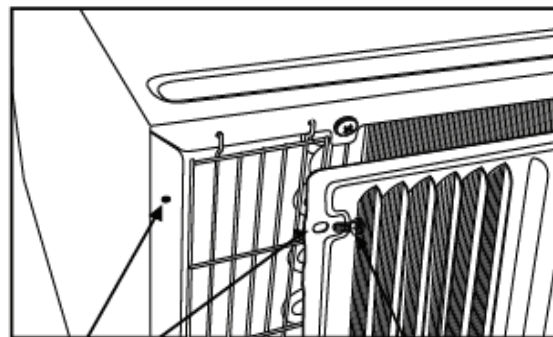

Fig. 3

1/8" Hole
Grille &
Flange

#8 Screw

INSTALLATION INSTRUCTIONS (CONTINUED)



1. Install the 1" x 1½" x 84" long stuffer-seal between the wall-sleeve and the unit. A flat-bladed screwdriver or putty knife is recommended.



2. Assemble the trim frame by inserting top and bottom pieces into side pieces and snapping into place.

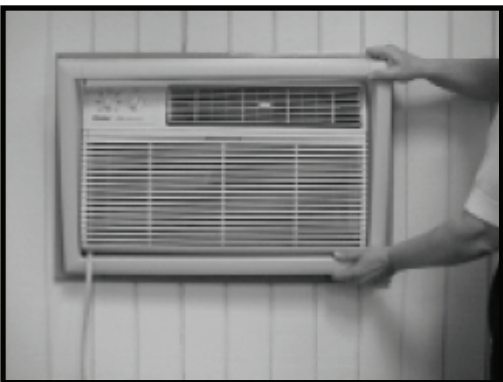
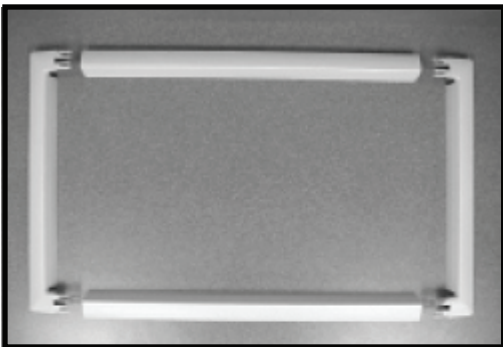

3. Pull cord through trim frame, then slide in unit until flush with wall.

CARE AND CLEANING

⚠ CAUTION

Clean air conditioner occasionally to keep it looking and operating like new. **Be sure to unplug the unit before cleaning to prevent shock or fire hazards.**

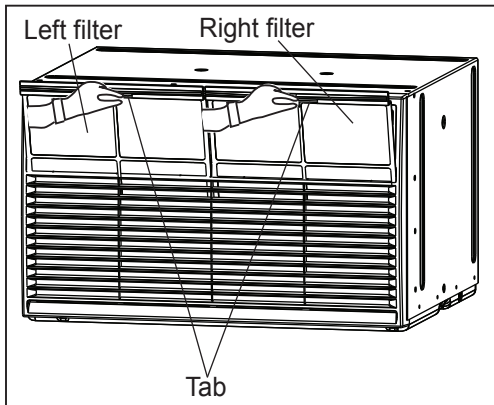

Air Filter Cleaning

The air filter should be cleaned at least every two weeks or as necessary. Trapped particles in the filter can build up and cause an accumulation of frost on the cooling coils.

- Grasp the filter by the center and pull up and out
- Wash the filter using liquid dishwashing detergent and warm water. Rinse filter thoroughly.
- Gently shake excess water from the filter. Be sure the filter is thoroughly dry before replacing.
- As an alternative, vacuum the filter clean.

NOTE: Never use hot water over 104°F (40°C) to clean the air filter. Never attempt to operate the unit without the air filter.

Cabinet Cleaning

- Be sure to unplug the air conditioner to prevent shock or fire hazard. The cabinet and front may be dusted with an oil-free cloth or washed with a cloth dampened in a solution of warm water and mild liquid dishwashing detergent. Rinse thoroughly and wipe dry.
- Never use harsh cleaners, wax or polish on the cabinet front.
- Be sure to wring excess water from the cloth before wiping the controls. Excess water in or around the controls may cause damage to the air conditioner.
- Plug in air conditioner after unit has dried completely.

Winter Storage

If air conditioner will be stored during the winter, remove it carefully from the wall according to the installation instructions. Cover it with plastic or return it to the original carton.

Always store unit in upright position.

TROUBLESHOOTING TIPS

Before calling for service, please review the chart below.

Issue	Possible Solutions
AIR CONDITIONER NOT COOLING ROOM, OR NOT BLOWING COLD AIR	<ul style="list-style-type: none"> • Be sure unit is not too large or too small for the area of the room. • Verify that all doors, windows, curtains and any other openings are closed off. Verify nothing is obstructing the front grille of unit, such as curtains, etc. • Allow enough time for room to cool, especially if outside temp is very high. • Check that the filter is not dirty and louvers are open all the way and blowing in the direction desired. • Check that unit is set to Cool Mode and that temperature is down enough (but not too low). • If unit is near a heat source, such as a stove, etc., then relocate unit. • If air coming from unit is cool to the touch, then unit is working properly; please double check the first three bullet points above. • If using Follow Me remote feature, move remote away from unit. • Temperature sensor behind air filter touching cold coil. These two elements should not be touching. Carefully straighten tube away from coil. • Unplug unit for at least 5 minutes. Follow Reset instructions on plug.
AIR CONDITIONER COOLING BUT ROOM IS TOO WARM - ICE FORMING ON COOLING COIL BEHIND DECORATIVE FRONT	<ul style="list-style-type: none"> • Outdoor temperature is below 64°F (18°C). To defrost the coil, set to Fan Only mode. • Air filter may be dirty. Clean filter. Refer to Care and Cleaning section. To defrost, set to Fan Only mode. • Thermostat is set too cold for night-time cooling. To defrost the coil, set to Fan Only mode. Then, set temperature to a higher setting.
AIR CONDITIONER CYCLING ON AND OFF TOO FREQUENTLY OR NOT ENOUGH	<ul style="list-style-type: none"> • Be sure unit is not too large or too small for the area of the room. • Remove grille and make sure the temperature sensor is not too close to the coils. These two elements should not be touching. Carefully straighten tube away from coil. • Make sure nothing is blocking the grille or side vents. • Make sure there is no dirt or debris inside the unit or on the filter.
UNIT WILL NOT TURN ON	<ul style="list-style-type: none"> • Reset circuit breaker. Make sure there are not too many items (ie lamps, TV's, etc.) working off the same breaker. • Check plug connection. • If plug is operating on an on/off switch, be sure that the switch is 'on'. • Try plugging unit into another outlet. • Unplug unit for at least 5 minutes. Follow Reset instructions on plug.
UNIT BLOWS FUSES OR POPS CIRCUIT BREAKER	<ul style="list-style-type: none"> • Make sure there are enough available amps on the circuit for the air conditioner. • Large units which run on a 230v will require a dedicated 20 or 30 amp circuit.
AIR CONDITIONER IS MAKING NOISES	<ul style="list-style-type: none"> • Check to be sure the unit is free from debris such as leaves, sticks, etc. Verify nothing is obstructing the unit. • Check the fan blade for cracks or chips. • Make sure the unit is properly and securely mounted inside the window or wall. • Clean the air filter.
WATER PUDDLES INSIDE UNIT OR IS COMING INTO ROOM	<ul style="list-style-type: none"> • Adjust the slope of the unit so that it drains downward toward the exterior of the home. (See Installation Instructions.) • Make sure that there is no debris blocking the drainage area of the unit.
WATER DRIPPING OUTSIDE	<ul style="list-style-type: none"> • Unit is removing a large quantity of moisture from a humid room. This is normal during excessively humid days.
REMOTE SENSING / FOLLOW ME DEACTIVATING PREMATURELY	<ul style="list-style-type: none"> • Remote control not located within range. Place remote control within 20 ft and 180° radius of the front of the unit. • Remote control signal obstructed. Remove obstruction.

NOTE: A highly recommended troubleshoot for any issue in general consists of turning off unit and unplugging for 5 minutes. It is also recommended to try another wall outlet.



COMFORT...BUILT TO LAST

Distributed by:

Perfect Aire, LLC
5151 Belt Line Rd.
Suite 878
Dallas, TX 75254

844-472-2473
www.perfectaire.us

Specification and performance data is subject to change without notice.

Printed in China