

DS509

Slim Tilt Mount with PC Holder

For 25"-60" (63-152cm) Flat Panel TVs

Designed to wall mount smaller computers, the DS509 is a low-profile universal solution for digital signage applications. Its bottom disengaging design allows the screen to have a negative tilt that enables quick and easy computer maintenance without having to remove the screen. Engineered for strength, durability and easy installation this mount offers VESA compliance and is compatible with Peerless PLP adapter plate technology to accommodate any flat panel display.



Screen size: 25"-60" (63-152cm)



Max load: 200 lb (91kg)

FEATURES

- Rated to 200 lb (91 kg) for dual studs, 60 lb (27 kg) for single metal studs
- PLP adapter plate compliant
- VESA® 100, 200, 100 x 200 and 200 x 100mm compliant
- Tilts at 0, 5 & 10 degrees
- Accommodates computers up to 2.0" x 14.90" x 9.0" (51 x 378 x 229mm)
- The computer can be removed and serviced without having to remove the flat panel screen
- Screens can be mounted in both landscape and portrait

■ **UNIVERSAL COMPATIBILITY**
VESA® and PLP compliant

■ **COMPONENT STORAGE**
Slim design houses computers inside the mount

■ **PERFECT VIEWING ANGLE**
0, 5 and 10 degree tilt options

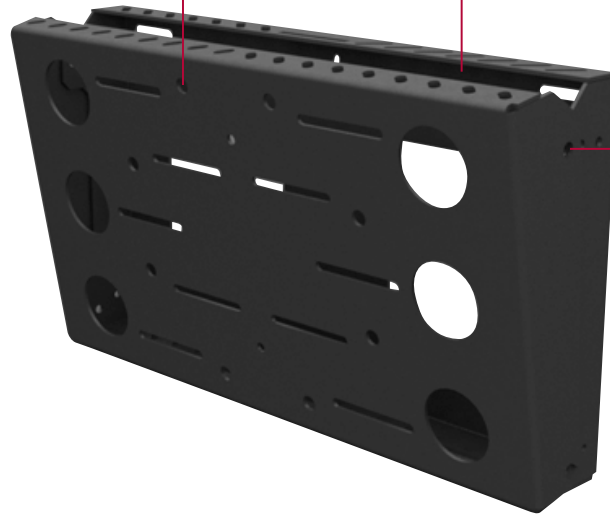

Fully Tilted At 10 Degrees



Computer Access

* Wall interference could prohibit quick computer access on screens over 40" (1016mm)



Model Numbers

WARRANTY: Limited 5-year

DS509 Slim Tilt Mount with PC Holder for 25"-60" (63-152cm) Flat Panel TVs

Product Specifications

	DIMENSIONS (W x H x D)	PRODUCT WEIGHT	LOAD CAPACITY	FINISH	AVAILABLE COLORS
DS509	2.75" x 18.27" x 10.27" (70 x 464 x 261mm)	13 lb (6kg)	200 lb (91kg)	Powder coat	Matte black

Package Specifications

	PACKAGE SIZE (W x H x D)	PACKAGE SHIP WEIGHT	PACKAGE UPC CODE	PACKAGE CONTENTS	UNITS IN PACKAGE
DS509	4.38" x 26.88" x 16" (111 x 683 x 406mm)	14 lb (6kg)	735029263364	Wall plate, adapter plate and mounting hardware	1

Accessories

PLP Adapter Plates For screens with mounting hole patterns larger than 200 x 200 mm

All dimensions = inch (mm)

* Wall interference could prohibit quick computer access on screens over 40" (1016mm)

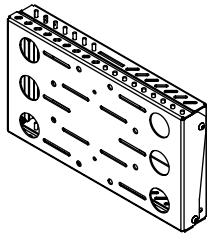

FRONT ISO VIEW

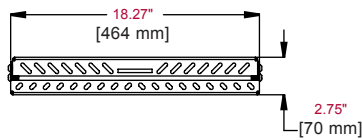

TOP VIEW

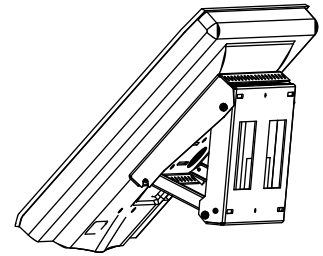

ACCESS ISO VIEW

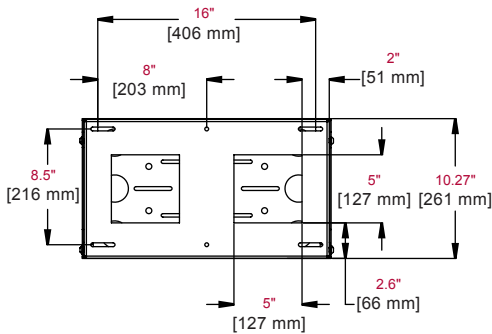

BACK VIEW

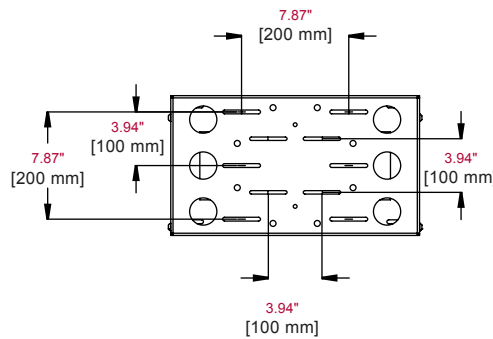

FRONT VIEW

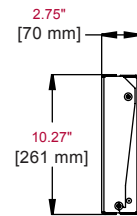

SIDE VIEW

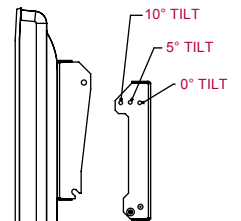

TILT VIEW

ARCHITECTS SPECIFICATIONS

The Custom Wall Mount shall be a Peerless model DS509 and shall be attached where indicated on the plans. Assembly and installation shall be done according to the instructions provided by the manufacturer.