

Operating Instructions Functional Manual

DLP™ Projector Commercial Use

Model No. **PT-JW130FBE**
PT-JW130FWE

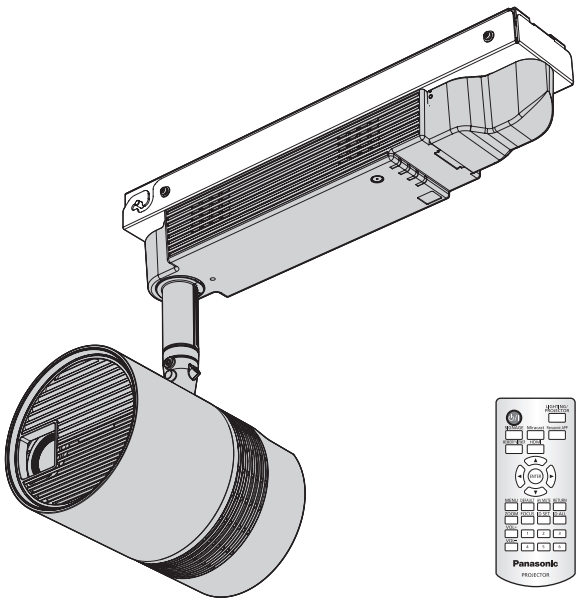

* Above illustration is shown in combination of this product and optional Ceiling Kit.

Thank you for purchasing this Panasonic product.

- This product is used in combination with optional Ceiling Kit (Model No.: ET-JPC100BE/ET-JPC100WE) or Floor Stand Kit (Model No.: ET-JPF100BE/ET-JPF100WE). This product cannot be used by itself.
- Before operating this product, please read the instructions carefully and save this manual for future use.
- Before using this product, be sure to read “Read this first!” (➔ pages 4 to 12).



HDMI™
HIGH-DEFINITION MULTIMEDIA INTERFACE



Contents

Read this first!	4	Using SD cards	49
Declaration of Conformity.....	11	Notes on use.....	49
Chapter 1 Preparation		Data protection.....	49
Precautions for use	17	Cards that can be used with the projector.....	49
Cautions when installing.....	17	Inserting an SD card.....	50
Cautions when transporting.....	19	Ejecting the SD card.....	50
Security.....	20	Operating with the remote control	51
Notes regarding the wireless LAN.....	20	Switching the projection mode.....	51
Art-Net.....	21	Switching the input.....	51
Cautions on use.....	21	Adjusting the volume.....	52
Disposal.....	22	Using the AV mute function.....	52
Accessories.....	23	Setting the remote control ID numbers.....	52
Optional accessories.....	24	Chapter 4 Settings	
About your projector	25	Menu navigation	55
Remote control.....	25	Navigating through the menu.....	55
Projector body.....	26	Main menu.....	56
Preparing the remote control	28	Sub-menu.....	57
Inserting and removing the batteries.....	28	[LIGHTING] menu	60
When using the multiple projectors.....	28	[PATTERN].....	60
Operating range of the remote control	29	[COLOR SETTING].....	60
Chapter 2 Getting Started		[DIMMER].....	62
Before the installation	31	[PICTURE] menu	63
Projection mode.....	31	[PICTURE MODE].....	63
Installation method.....	31	[CONTRAST].....	63
Installation form.....	31	[BRIGHTNESS].....	64
Projection direction.....	33	[COLOR].....	64
Projection dimensions.....	34	[TINT].....	64
Setting up	36	[COLOR TEMPERATURE].....	64
Installing the projector.....	36	[DIMMER].....	65
Adjusting the projection position.....	36	[MEMORY VIEWER] menu	66
Connecting	38	[VIEW].....	66
Before connecting.....	38	[SORT].....	66
Connecting example: External devices.....	38	[AUTOPLAY].....	66
Attaching the caps to the connecting terminals.....	39	[INTERVAL].....	66
Chapter 3 Basic Operations		[EFFECT].....	67
Turning on/off the projector	41	[GUIDE].....	67
Power indicator.....	41		
Turning on the projector.....	42		
When the initial setting screen is displayed.....	42		
Making adjustments and selections.....	45		
Turning off the projector.....	45		
Projecting	47		
Selecting the projection mode.....	47		
Selecting the input (for projector mode).....	47		
Adjusting the projection.....	48		

Contents

[SETUP] menu	68	Web control function	105
[PROJECTOR ID].....	68	Computer that can be used for setting.....	105
[PROJECTION METHOD].....	68	Accessing from the web browser.....	105
[VERTICAL FLIP].....	68	Miracast function	126
[ASPECT].....	68	Content Manager	127
[KEYSTONE].....	69	Files compatible with signage playback.....	127
[SIGNAGE].....	70	Computers for the signage setting.....	128
[HIGH ALTITUDE MODE].....	71	Procedure of signage setting.....	128
[ECO MANAGEMENT].....	71	Description of the signage playback screen.....	129
[INITIAL STARTUP].....	72	Accessing from the web browser.....	129
[STARTUP INPUT SELECT].....	73	[Schedule].....	131
[AUDIO SETTING].....	73	Playing back the schedule simultaneously in multiple projectors.....	182
[STATUS].....	74	[Slideshow].....	185
[DATE AND TIME].....	74	Registering a lighting pattern.....	193
[SAVE ALL USER DATA].....	75	[Effect].....	197
[LOAD ALL USER DATA].....	75	[Color].....	198
[INITIALIZE].....	76		
[SERVICE PASSWORD].....	76		
[NETWORK] menu	77		
[PROJECTOR NAME].....	77		
[WIRED LAN].....	77		
[WIRELESS LAN].....	78		
[NETWORK CONTROL].....	81		
[Panasonic APPLICATION].....	81		
[NETWORK STATUS].....	83		
[Art-Net].....	83		
[DISPLAY OPTION] menu	87		
[HDMI IN].....	87		
[ON-SCREEN DISPLAY].....	87		
[AV MUTE].....	88		
[DISPLAY LANGUAGE] menu	89		
Changing the display language.....	89		
[SECURITY] menu	90		
[SECURITY PASSWORD].....	90		
[SECURITY PASSWORD CHANGE].....	90		
[TEST PATTERN] menu	91		
[TEST PATTERN].....	91		
Chapter 5 Operations		Chapter 6 Maintenance	
Memory Viewer function	93	Light source/temperature indicators	200
Files that can be played back with the Memory Viewer function.....	93	When an indicator lights up.....	200
Displaying the Memory Viewer screen.....	93	Inspection and maintenance	202
Operating the Memory Viewer screen.....	94	Before maintaining the projector.....	202
Playing back still images.....	96	Maintenance.....	202
Playing back movies.....	97	Inspection.....	202
Direct playback.....	99	Troubleshooting	203
Memory Viewer screen descriptions.....	99	FAQ	204
Network connection	101		
When connecting via wired LAN.....	101		
When connecting via wireless LAN.....	102		
		Chapter 7 Appendix	
		Technical information	206
		Using the PJLink protocol.....	206
		Using Art-Net function.....	207
		Control commands via LAN.....	207
		Glossary of network terms	211
		Specifications	213
		Dimensions.....	214
		List of compatible signals.....	215
		Index	216

Read this first!

WARNING: THIS APPARATUS MUST BE EARTHED.

WARNING: To prevent damage which may result in fire or shock hazard, do not expose this appliance to rain or moisture.
This device is not intended for use in the direct field of view at visual display workplaces. To avoid incommoding reflexions at visual display workplaces this device must not be placed in the direct field of view.
The equipment is not intended for used at a video workstation in compliance BildscharbV.

The sound pressure level at the operator position is equal or less than 70 dB (A) according to ISO 7779.

WARNING:

1. Disconnect the power to the projector by turning off the power supply for the interior wiring or disconnecting the power plug from an outlet when this unit is not in use for a prolonged period of time.
2. To prevent electric shock, do not remove cover. No user serviceable parts inside. Refer servicing to qualified service personnel.
3. When using the optional Floor Stand Kit, do not remove the earthing pin on the mains plug. This apparatus is equipped with a three prong earthing-type mains plug. This plug will only fit an earthing-type mains socket. This is a safety feature. If you are unable to insert the plug into the mains socket, contact an electrician. Do not defeat the purpose of the earthing plug.

This is a device to project images onto a screen, etc., and is intended for use as indoor lighting.

Directive 2009/125/EC

WARNING: RISK OF ELECTRIC SHOCK. DON'T OPEN.



Indicated on the projector



The lightning flash with arrowhead symbol, within an equilateral triangle, is intended to alert the user to the presence of uninsulated "dangerous voltage" within the product's enclosure that may be of sufficient magnitude to constitute a risk of electric shock to persons.



The exclamation point within an equilateral triangle is intended to alert the user to the presence of important operating and maintenance (servicing) instructions in the literature accompanying the product.

CAUTION: To assure continued compliance, follow the attached installation instructions. This includes using shielded interface cables when connecting to computer or peripheral devices. Also, any unauthorized changes or modifications to this equipment could void the user's authority to operate this device.

Notice on laser

This projector is the Class 2 laser product that complies with IEC / EN 60825-1 : 2007.

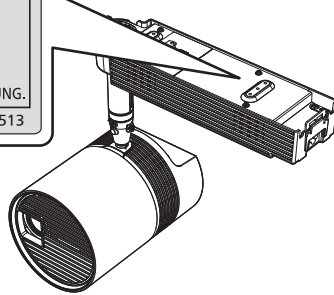
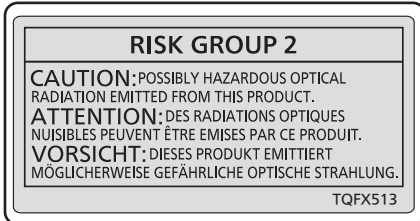
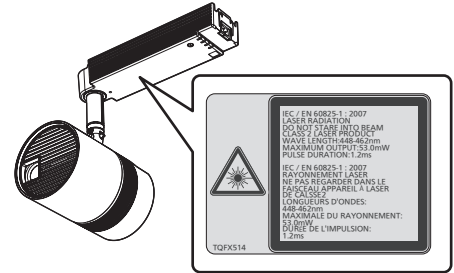

(Top of product)

Authorized Representative's name and address within the European Union

Panasonic Marketing Europe GmbH

Panasonic Testing Center

Winsbergring 15, 22525 Hamburg, Germany

WARNING:

■ POWER (When optional Ceiling Kit is used)

The circuit breaker (with rated current of 16 A or less) shall be installed near the equipment and shall be easily accessible when problems occur. If the following problems occur, cut off the power supply immediately.

Continued use of the projector in these conditions will result in fire, electric shock, or exposure to dangerous laser radiation.

- If foreign objects or water get inside the projector, cut off the power supply.
- If you notice smoke, strange smells or noise coming from the projector, cut off the power supply. Please contact your dealer for repairs, and do not attempt to repair the projector yourself.

During a thunderstorm, do not touch the projector.

Electric shocks can result.

■ POWER (When optional Floor Stand Kit is used)

The wall outlet shall be installed near the equipment and shall be easily accessible when problems occur. If the following problems occur, cut off the power supply immediately.

Continued use of the projector in these conditions will result in fire or electric shock.

- If foreign objects or water get inside the projector, cut off the power supply.
- If you notice smoke, strange smells or noise coming from the projector, cut off the power supply. Please contact your dealer for repairs, and do not attempt to repair the projector yourself.

During a thunderstorm, do not touch the projector or the cable.

Electric shocks can result.

Do not do anything that might damage the power cord or the power plug.

If the power cord is used while damaged, electric shocks, short-circuits or fire will result.

- Do not damage the power cord, make any modifications to it, place it near any hot objects, bend it excessively, twist it, pull it, place heavy objects on top of it or wrap it into a bundle.

Ask your dealer to carry out any repairs to the power cord that might be necessary.

Do not use a power cord other than the one supplied with the optional accessories.

Using the power cord other than the one supplied with the optional Floor Stand Kit may cause shorting or overheating, result in electric shocks or fire. Also, using the power cord supplied with the optional accessories without grounding at the outlet side may cause electric shocks.

Completely insert the power plug into the wall outlet and the power connector into the projector terminal.

If the plug is not inserted correctly, electric shocks or overheating will result.

- Do not use plugs which are damaged or wall outlets which are coming loose from the wall.

Do not handle the power plug and power connector with wet hands.

Failure to observe this will result in electric shocks.

Do not overload the wall outlet.

If the power supply is overloaded (ex., by using too many adapters), overheating may occur and fire will result.

Clean the power plug regularly to prevent it from becoming covered in dust.

Failure to observe this will cause a fire.

- If dust builds up on the power plug, the resulting humidity can damage the insulation.
- If not using the projector for an extended period of time, pull the power plug out from the wall outlet.

Pull the power plug out from the wall outlet and wipe it with a dry cloth regularly.

■ ON USE/INSTALLATION

Ask your dealer or a building electrician for installing the projector to the ceiling.

Inadequate installation may result in a fire, an electric shock, or a falling accident.

- Work of electrical wiring must be performed by qualified personnel only.

Use the installation kit (Ceiling Kit) specified by Panasonic when the projector is used by installing on the ceiling.

Inadequate kit may result in a falling accident, a fire, or an electric shock.

Use the installation kit (Floor Stand Kit) specified by Panasonic when the projector is used standing on the floor.

Inadequate stand may result in a tipping accident, a fire, or an electric shock.

WARNING:

Secure the safety of a foothold when directly accessing the main unit of the projector if the projector is installed on the ceiling.

You may tip over or fall down when adjusting the image position or inserting/removing the SD card, resulting in an injury.

Do not install the projector on a ceiling that cannot bear the weight.

Doing so may result in a fire or an electric shock due to falling of the projector.

Do not install the projector in a location that cannot bear the weight, location that is not stable, or location that is tilted when the projector is used standing on the floor.

Doing so may result in the projector falling off or tipping, causing damage or deformation, or a serious accident or injury.

Do not install the projector close to the doorway of a room or in an aisle.

Doing so may collide to the projector or get your feet caught in the power cord, resulting in a fire, an electrical shock, or an injury.

Do not set up the projector in humid or dusty places or in places where the projector may come into contact with oily smoke or steam.

Using the projector under such conditions will result in fire, electric shocks or deterioration of components. Deterioration of components may cause the projector to fall down.

Do not place the projector on soft materials such as carpets or sponge mats.

Doing so will cause the projector to overheat, which can cause burns, fire or damage to the projector.

Do not use the projector whose outer case is damaged due to falling or other reasons.

Continued use of the projector in such a condition will result in fire, electric shock, or exposure to dangerous laser radiation.

Please contact your dealer for repairs, and do not attempt to repair the projector yourself.

Do not cover the air intake/exhaust ports.

Doing so will cause the projector to overheat, which can cause fire or damage to the projector.

- Do not place the projector in narrow, badly ventilated places.
- Do not bring a cloth or papers close to the projector, as these materials could be drawn into the air intake port.
- Keep the air intake/exhaust ports on the power supply unit away from walls or objects by 300 mm (11-13/16") or more.

Do not look at or place your skin into the light emitted from the lens while the projector is being used.

Doing so can cause burns or loss of sight.

- Strong light is emitted from the projector's lens. Do not look at or place your hands directly into this light.
- Be especially careful not to let young children look into the lens. In addition, when moving away from the projector while it is in use, turn off the power of the projector, and turn off the power supply of the interior wiring. Or, disconnect the power plug from the outlet.

Never attempt to remodel or disassemble the projector.

High voltages can cause fire or electric shocks.

- For any inspection, adjustment and repair work, please contact your dealer.

Doing so may cause exposure to dangerous laser radiation.

- The laser module is built in this projector. Follow procedures specified in the Operating Instructions to make operations and adjustments.

Do not allow metal objects, flammable objects, or liquids to enter inside of the projector. Do not allow the projector to get wet.

Doing so may cause short circuits or overheating, and result in fire, electric shock, or malfunction of the projector.

- If liquid enters inside of the projector, cut off the power supply and consult your dealer.

WARNING:

■ **ACCESSORIES**

Do not use or handle the batteries improperly, and refer to the following.

Failure to observe this will cause burns, batteries to leak, overheat, explode or catch fire.

- Do not use unspecified batteries.
- Do not use chargeable batteries.
- Do not disassemble dry cell batteries.
- Do not heat the batteries or place them into water or fire.
- Do not allow the + and – terminals of the batteries to come into contact with metallic objects such as necklaces or hairpins.
- Do not store or carry batteries together with metallic objects.
- Store the batteries in a plastic bag and keep them away from metallic objects.
- Make sure the polarities (+ and –) are correct when inserting the batteries.
- Do not use a new battery together with an old battery or mix different types of batteries.
- Do not use batteries with the outer cover peeling away or removed.

If the battery fluid leaks, do not touch it with bare hands, and take the following measures if necessary.

- Battery fluid on your skin or clothing could result in skin inflammation or injury.
Rinse with clean water and seek medical advice immediately.
- Battery fluid coming in contact with your eyes could result in loss of sight.
In this case, do not rub your eyes. Rinse with clean water and seek medical advice immediately.

Remove the depleted batteries from the remote control promptly.

- Leaving them in the unit may result in fluid leakage, overheating, or explosion of the batteries.

Do not allow children to reach the batteries and covers.

Accidentally swallowing them can cause physical harm.

- If swallowed, seek medical advice immediately.

CAUTION:

■ **POWER (When optional Ceiling Kit is used)**

Cut off the power supply before carrying out any cleaning.

Failure to do so may result in electric shock.

- Disconnect the power supply of the interior wiring with the circuit breaker to disconnect the power to the projector.

■ **POWER (When optional Floor Stand Kit is used)**

When disconnecting the power cord, be sure to hold the power plug and power connector.

If the power cord itself is pulled, the lead will become damaged, and fire, short-circuits or serious electric shocks will result.

When not using the projector for an extended period of time, disconnect the power plug from the wall outlet.

Failure to do so may result in fire or electric shock.

Disconnect the power plug from the wall outlet before carrying out any cleaning.

Failure to do so may result in electric shock.

CAUTION:

■ ON USE/INSTALLATION

Do not place the projector in extremely hot locations.

Doing so will cause the outer casing or internal components to deteriorate, or result in fire.

- Take particular care in locations exposed to direct sunlight or near heaters.

Do not install the projector in a location where salt pollution or corrosive gas may occur.

Doing so may result in falling due to corrosion.

Install the projector on a horizontal ceiling or sloped ceiling up to 45° in a specified direction when the projector is used by installing on the ceiling.

Installing on a wall, a floor, or an excessively sloped ceiling, or installing in a wrong direction may result in a falling accident.

Do not use the projector together with dimmers such as a light controller.

Doing so will result in the damage to the components inside the projector and will cause fire.

Do not put excessive force on the projector by hanging on the projector or dangling any object.

Doing so will result in falling of the projector.

Do not place heavy objects on top of the projector.

Failure to observe this will cause the projector to become unbalanced and fall, which could result in damage or injury. The projector will be damaged or deformed.

Do not put your weight on this projector.

You could fall or the projector could break, and injury will result.

- Be especially careful not to let young children stand or sit on the projector.

Do not place your hands or other objects close to the air exhaust port.

Doing so will cause burns or damage your hands or other objects.

- Heated air comes out of the air exhaust port. Do not place your hands or face, or objects which cannot withstand heat close to this port.

Do not stand in front of the lens while the projector is being used.

Doing so can cause damage and burns to clothing.

- Extremely strong light is emitted from the projector's lens.

Do not place objects in front of the lens while the projector is being used.

Doing so can cause fire, damage to an object, or malfunction of the projector.

- Extremely strong light is emitted from the projector's lens.

Always disconnect all cables before moving the projector.

Moving the projector with cables still attached can damage the cables, which will cause fire or electric shocks to occur.

Never plug headphones and earphones into <AUDIO OUT> terminal.

Excessive sound pressure from headphones and earphones can cause hearing loss.

Do not allow unattended children to use the projector.

Incorrect handling will cause them to be exposed to dangerous laser radiation.

- Use the projector under the supervision and control of adults.

■ ACCESSORIES

When not using the projector for an extended period of time, remove the batteries from the remote control.

Failure to observe this will cause the batteries to leak, overheat, catch fire or explode, which may result in fire or contamination of surrounding area.

■ MAINTENANCE

Ask your dealer about inspection by a qualified technician once every three years.

Using the projector for long time without inspection may result in fire, electric shocks, or falling of the projector.

- For inspection fee, ask your dealer.



To remove the battery

Remote Control Battery

1. Press the guide and lift the cover.

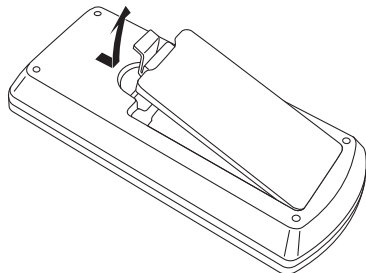

2. Remove the batteries.

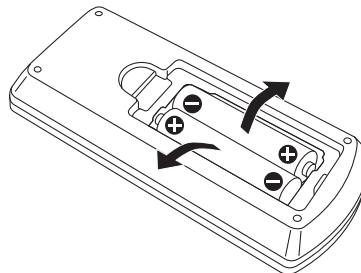

Declaration of Conformity



Declaration of Conformity (DoC)

This equipment is in compliance with the essential requirements and other relevant provisions of Directive 1999/5/EC. Customers can download a copy of the original DoC for this product from our DoC server: <http://www.ptc.panasonic.de>
Contact in the EU: Panasonic Marketing Europe GmbH, Panasonic Testing Center, Winsbergring 15, 22525 Hamburg, Germany

This product is intended to be used in the following countries.

Austria, Belgium, Bulgaria, Czech, Cyprus, Denmark, Estonia, Finland, France, Germany, Greece, Hungary, Iceland, Ireland, Italy, Latvia, Lithuania, Luxembourg, Malta, Netherlands, Norway, Poland, Portugal, Romania, Slovenia, Slovak, Spain, Sweden, Switzerland, UK & Croatia



Déclaration de Conformité (DC)

Cet appareil est conforme aux exigences essentielles et aux autres dispositions pertinentes de la Directive 1999/5/EC. Les clients peuvent télécharger une copie de la DC originale pour ce produit à partir de notre serveur DC: <http://www.ptc.panasonic.de>
Coordonnées dans l'UE : Panasonic Marketing Europe GmbH, Panasonic Testing Center, Winsbergring 15, 22525 Hamburg, Germany

Ce produit est conçu pour l'utilisation dans les pays suivants.

Autriche, Belgique, Bulgarie, République Tchèque, Chypre, Danemark, Estonie, Finlande, France, Allemagne, Grèce, Hongrie, Islande, Irlande, Italie, Lettonie, Lituanie, Luxembourg, Malte, Pays-Bas, Norvège, Pologne, Portugal, Roumanie, Slovénie, Slovaquie, Espagne, Suède, Suisse, Royaume-Uni et Croatie



Declaración de conformidad (DC)

Este equipo cumple con los requisitos esenciales así como con otras disposiciones de la Directiva 1999/5/CE. El cliente puede descargar una copia de la DC original de este producto desde nuestro servidor DC: <http://www.ptc.panasonic.de>
Contacto en la U.E.: Panasonic Marketing Europe GmbH, Panasonic Testing Center, Winsbergring 15, 22525 Hamburg, Germany

Este producto ha sido desarrollado para el uso en los siguientes países.

Austria, Bélgica, Bulgaria, República Checa, Chipre, Dinamarca, Estonia, Finlandia, Francia, Alemania, Grecia, Hungría, Islandia, Irlanda, Italia, Letonia, Lituania, Luxemburgo, Malta, Holanda, Noruega, Polonia, Portugal, Rumania, Eslovenia, Eslovaquia, España, Suecia, Suiza, el Reino Unido y Croacia



Konformitätserklärung (KE)

Dieses Gerät entspricht den grundlegenden Anforderungen und den weiteren entsprechenden Vorgaben der Richtlinie 1999/5/EU.

Kunden können eine Kopie der Original-KE für dieses Produkt von unserem KE-Server herunterladen: <http://www.ptc.panasonic.de>
Kontaktadresse in der EG: Panasonic Marketing Europe GmbH, Panasonic Testing Center, Winsbergring 15, 22525 Hamburg, Germany

Dieses Produkt ist für den Einsatz in den folgenden Ländern vorgesehen.

Österreich, Belgien, Bulgarien, Tschechische Republik, Zypern, Dänemark, Estland, Finnland, Frankreich, Deutschland, Griechenland, Ungarn, Island, Irland, Italien, Lettland, Litauen, Luxemburg, Malta, Niederlande, Norwegen, Polen, Portugal, Rumänien, Slowenien, Slowakei, Spanien, Schweden, Schweiz, Großbritannien und Kroatien



Dichiarazione di conformità (DoC)

Questo apparato é conforme ai requisiti essenziali ed agli altri principi sanciti dalla Direttiva 1999/5/CE.

I clienti possono scaricare la copia del DoC originale per questo prodotto dal nostro server DoC: <http://www.ptc.panasonic.de>
Contatto nella EU: Panasonic Marketing Europe GmbH, Panasonic Testing Center, Winsbergring 15, 22525 Hamburg, Germany

I prodotti sono stati prodotti per l'uso nei seguenti paesi.

Austria, Belgio, Bulgaria, Repubblica Ceca, Cipro, Danimarca, Estonia, Finlandia, Francia, Germania, Grecia, Irlanda, Islanda, Italia, Lettonia, Lituania, Lussemburgo, Malta, Olanda, Norvegia, Polonia, Portogallo, Romania, Regno Unito, Slovenia, Slovacchia, Spagna, Svezia, Svizzera, Ungheria, Croazia

Read this first!

България

Това устройство отговаря на съществените изисквания и останалите приложими разпоредби на Директива 1999/5/ЕО.

Česky

Toto zařízení je v souladu se základními požadavky a ostatními odpovídajícími ustanoveními Směrnice 1999/5/EC.

Dansk

Dette udstyr er i overensstemmelse med de væsentlige krav og andre relevante bestemmelser i Direktiv 1999/5/EF.

Eesti

See seade vastab direktiivi 1999/5/EÜ olulistele nõuetele ja teistele asjakohastele sätetele.

Ελληνική

Αυτός ο εξοπλισμός είναι σε συμμόρφωση με τις ουσιώδεις απαιτήσεις και άλλες σχετικές διατάξεις της Οδηγίας 1999/5/ΕΚ.

Íslenska

Þetta tæki er samkvæmt grunnkröfum og öðrum viðeigandi ákvæðum Tilskipunar 1999/5/EC.

Latviski

Šī iekārta atbilst Direktīvas 1999/5/EK būtiskajām prasībām un citiem ar to saistītajiem noteikumiem.

Lietuvių

Šis įrenginys tenkina 1999/5/EB Direktyvos esminius reikalavimus ir kitas šios direktyvos nuostatas.

Nederlands

Dit apparaat voldoet aan de essentiële eisen en andere van toepassing zijnde bepalingen van de Richtlijn 1999/5/EC.

Malti

Dan l-apparat huwa konformi mal-ħtiġiet essenzjali u l-provedimenti l-oħra rilevanti tad-Direttiva 1999/5/EC.

Magyar

Ez a készülék teljesíti az alapvető követelményeket és más 1999/5/EK irányelvben meghatározott vonatkozó rendelkezéseket.

Norsk

Dette utstyret er i samsvar med de grunnleggende krav og andre relevante bestemmelser i EU-direktiv 1999/5/EF.

Polski

Urządzenie jest zgodne z ogólnymi wymaganiami oraz szczególnymi warunkami określonymi Dyrektywą UE: 1999/5/EC.

Português

Este equipamento está em conformidade com os requisitos essenciais e outras provisões relevantes da Directiva 1999/5/EC.

România

Acest echipament este conform cu cerințele de bază și celelalte prevederi relevante ale Directivei 1999/5/CE.

Slovensko

Ta naprava je skladna z bistvenimi zahtevami in ostalimi relevantnimi pogoji Direktive 1999/5/EC.

Slovensky

Toto zariadenie je v zhode so základnými požiadavkami a inými príslušnými nariadeniami direktív: 1999/5/EC.

Suomi

Tämä laite täyttää direktiivin 1999/5/EY olennaiset vaatimukset ja on siinä asetettujen muiden laitetta koskevien määräysten mukainen.

Svenska

Denna utrustning är i överensstämmelse med de väsentliga kraven och andra relevanta bestämmelser i Direktiv 1999/5/EC.

Hrvatski

Ovaj proizvod odgovara bitnim zahtjevima i drugim relevantnim uredbama Direktive 1999/5/EK.

■ Trademarks, etc.

- DLP and the DLP logo are registered trademarks or trademarks of Texas Instruments.
- HDMI, the HDMI Logo, and High-Definition Multimedia Interface are trademarks or registered trademarks of HDMI Licensing LLC in the United States and other countries.
- PJLink™ is a registered trademark or pending trademark in Japan, the United States, and other countries and regions.
- RoomView and Crestron RoomView are registered trademarks of Crestron Electronics, Inc. Crestron Connected™ and Fusion RV are trademarks of Crestron Electronics, Inc.
- Art-Net™ Designed by and Copyright Artistic Licence Holdings Ltd
- Wi-Fi®, Wi-Fi Direct™ and Miracast™ are registered trademarks or trademarks of Wi-Fi Alliance.
- SDHC Logo is a trademark of SD-3C, LLC.
- Windows, Windows Vista, and Internet Explorer are registered trademarks or trademarks of Microsoft Corporation in the United States and other countries.
- Mac, Mac OS, OS X, iPad, iPhone, iPod touch, and Safari are trademarks of Apple Inc., registered in the United States and other countries.
- IOS is a trademark or registered trademark of Cisco in the U.S. and other countries and is used under license.
- Google, Google Chrome and Android are trademarks or registered trademarks of Google Inc.
- Adobe, Adobe Flash Player, and Adobe Reader are trademarks or registered trademarks of Adobe Systems Inc. in the United States and/or other countries.
- Bluetooth® is a registered trademark owned by Bluetooth SIG, Inc.
- Some of the fonts used in the on-screen menu are Ricoh bitmap fonts, which are manufactured and sold by Ricoh Company, Ltd.
- The software included in this product is prohibited to transfer, copy, reverse assembling, reverse compiling, reverse engineering, and/or exporting against the exporting laws and regulations.
- The copyright protection laws will apply to the contents displayed using this product.
The manufacturer or the distributor of this product assumes no responsibility of any kind for the problem such as the infringement of copyright, caused by using this product. Take caution not to infringe the right of the copyright owner and any other right holder when editing and using the contents to display.
- This product is licensed under AVC Patent Portfolio License, VC-1 Patent Portfolio License, and MPEG-4 Visual Patent Portfolio License, and following actions except for the personal or non-profit use are not licensed.
 - Recording the image information in compliance with the AVC standard, the VC-1 standard, and the MPEG-4 Visual standard (AVC/VC-1/MPEG-4 video hereafter)
 - Playing back the AVC/VC-1/MPEG-4 video recorded by consumer practicing in a private activity, or AVC/VC-1/MPEG-4 video acquired from the licensed providerFor details, refer to the website of MPEG LA, LLC (<http://www.mpegla.com>).

The trademarks and product trademarks for various companies are fully respected even if they are not mentioned. Please note that the ® and ™ symbols are not specified in this manual.

Software information regarding this product

This product incorporates the following software.

- (1) the software developed independently by or for Panasonic Corporation
- (2) the software licensed under the GNU GENERAL PUBLIC LICENSE Version2.0 (GPL V2.0)
- (3) the software licensed under the GNU LESSER GENERAL PUBLIC LICENSE Version2.1 (LGPL V2.1)

The software that is categorized as (2) and (3) is distributed in the hope that it will be useful, but WITHOUT ANY WARRANTY, without even the implied warranty of MERCHANTABILITY or FITNESS FOR A PARTICULAR PURPOSE. For details, refer to the license conditions included in the supplied CD-ROM.

For customers who contacted the following contact center, Panasonic provides complete and machine-readable source code based on GPL V2.0, LGPL V2.1 or software licensed under other terms imposing source code disclosure obligations in actual expenses, together with information about each copyright owner, for a period of at least 3 years from the purchase of this product.

Contact Center (Email): sav.pj.gpl.pavc@ml.jp.panasonic.com

■ Illustrations in this manual

- Unless otherwise specified, the illustration of installation status of the projector in this document is using the optional Ceiling Kit.
- Illustrations of the projector, combination status with the optional accessories, and screen may vary from the actual product.

■ Reference pages

- Reference pages in this manual are indicated as (➡ page 00).

■ Terms

- In this manual, the “Wireless remote control unit” accessory is referred to as “Remote control”.
- In this manual, the SD memory card and the SDHC memory card are referred to as “SD card”.

Features of the Projector

Variety of projection function

- ▶ The lighting mode just like a spotlight and the projector mode that can project image can be switched in just one touch.
- ▶ Various playback method can be selected, such as projecting the still image/movie in the SD card just with the projector, projecting the image in the computer by transmitting it wirelessly, projecting the contents of the Blu-ray disc via HDMI.
- ▶ The signage function is installed allowing to play back the still image/movie/music file in the SD card, change the brightness of the light source, and turn off/on the projector according to the schedule created by yourself.

Easy setup and improved serviceability

- ▶ Two installation methods of ceiling mount and floor standing are supported*1.
- ▶ The display can be freely layout by projecting the image vertically or horizontally.
- ▶ The projector is equipped with an electric 2.2x zoom, electric focus lens.

*1 This product is used in combination with the optional Ceiling Kit or Floor Stand Kit. This product cannot be used by itself.

A design fitting in to the space

- ▶ A spotlight type design is adopted to easily conform to a space requiring conformity to the design, such as a store.

Quick Steps

For details, refer to the corresponding pages.

1. Install the projector in combination with the optional accessory.

(➔ page 36)

- Be sure to ask your dealer or a building electrician for installing the projector to the ceiling with the optional Ceiling Kit. To use the projector standing on the floor, refer to the Operating Instructions of the Floor Stand Kit.



2. Connect with external devices.

(➔ page 38)



3. Switch on the projector.

(➔ page 42)



4. Make initial settings.

(➔ page 42)

- Take this step when you switch on the power for the first time after purchasing the projector.



5. Select the projection mode.

(➔ page 47)



6. Select the input to project.

(➔ page 47)

- This is a step to perform when the projector mode is selected.



7. Adjust the projection.

(➔ page 48)

Chapter 1 Preparation

This chapter describes things you need to know or check before using the projector.

Precautions for use

Cautions when installing

■ Use the projector in combination with the optional Ceiling Kit or Floor Stand Kit.

To use the projector, the optional Ceiling Kit (Model No.: ET-JPC100WE, ET-JPC100BE) or Floor Stand Kit (Model No.: ET-JPF100WE, ET-JPF100BE) is required.

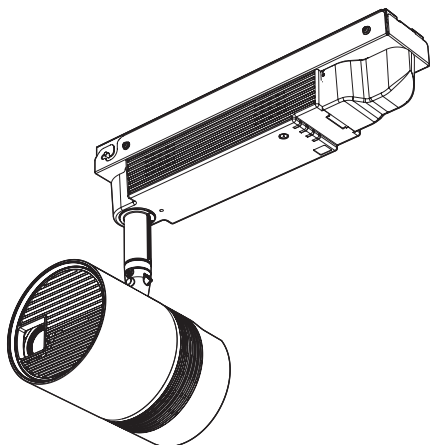

Installation example when installing on the ceiling

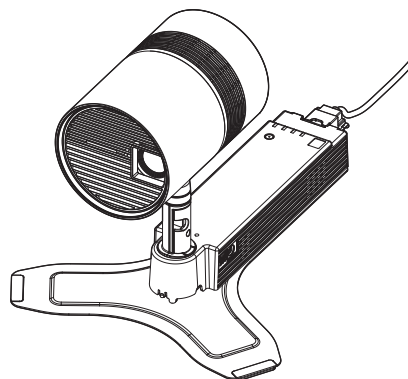

Installation example when standing on the floor

■ Do not set up the projector outdoors.

The projector is designed for indoor use only.

■ Do not set up the projector in the following locations.

- Places where vibration and impacts occur such as in a car or vehicle: Doing so may cause damage to internal components or malfunction.
- Location close to sea or where corrosive gas may occur: The projector may fall due to corrosion. Also, it may shorten the life of the components and result in malfunctions.
- Near the exhaust of an air conditioner: Depending on the conditions of use, the screen may fluctuate in rare cases due to the heated air from the air exhaust port or the hot or cooled air. Make sure that the exhaust from the projector or other equipment, or the air from the air conditioner does not blow toward the front of the main unit of the projector.
- Places with sharp temperature fluctuations near lights (such as studio lamps): Doing so may result in deformation of the projector due to heat, which may cause malfunctions.
The operating environment temperature of the projector should be between 0 °C (32 °F) and 40 °C (104 °F) when using it at elevations lower than 1 000 m (3 281') above sea level, and between 0 °C (32 °F) and 35 °C (95 °F) when using it at elevations between 1 000 m (3 281') and 2 700 m (8 858') above sea level.
- Near high-voltage power lines or near motors: Doing so may interfere with the operation of the projector.
- Places where there is high-power laser equipment: Directing a laser beam onto the lens surface causes damage to the DLP chip.

■ Do not install the projector at elevations of 2 700 m (8 858') or higher above sea level.

Doing so may shorten the life of the components and result in malfunctions.

■ Make sure to set [HIGH ALTITUDE MODE] to [HIGH1] when using the projector at elevations between 1 000 m (3 281') and 2 000 m (6 562') above sea level, and set [HIGH ALTITUDE MODE] to [HIGH2] when using the projector at elevations between 2 000 m (6 562') and 2 700 m (8 858').

Failure to do so may shorten the life of the components and result in malfunctions.

■ Be sure to ask your dealer or a building electrician for installing the projector to the ceiling with the optional Ceiling Kit.

- The optional Ceiling Kit is required.

- Work of electrical wiring must be performed by qualified personnel only.
- Panasonic takes no responsibility for any damage to the projector caused by mounting the product to ceiling in any method not specified by Panasonic or caused by inappropriate installation environment, even if the warranty period of the projector has not expired.

■ **When using the optional Ceiling Kit, do not install the projector on a sloped ceiling exceeding 45°, wall, or floor.**

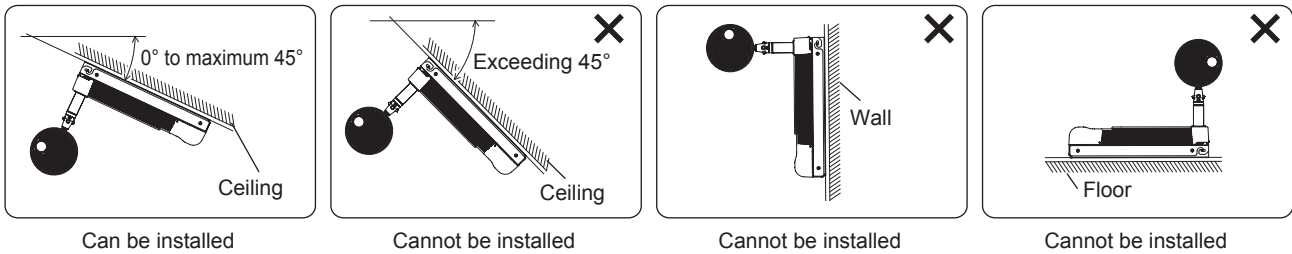

■ **Do not install the projector on a ceiling with the power supply unit tilted right or left.**

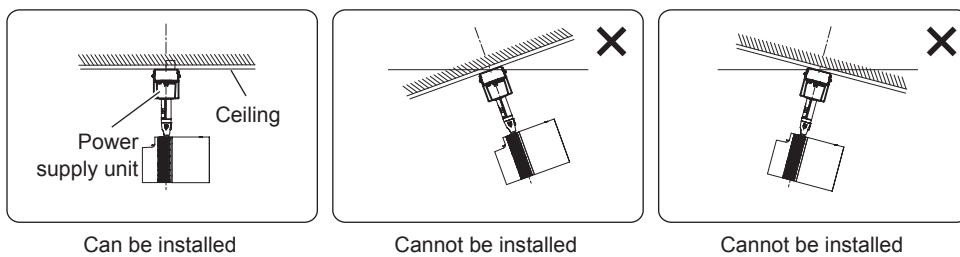

■ **When installing the projector on a sloped ceiling, install in a direction that the pole side of the power supply unit will be higher than the power $\langle \text{⏻} / \text{⏻} \rangle$ button side.**

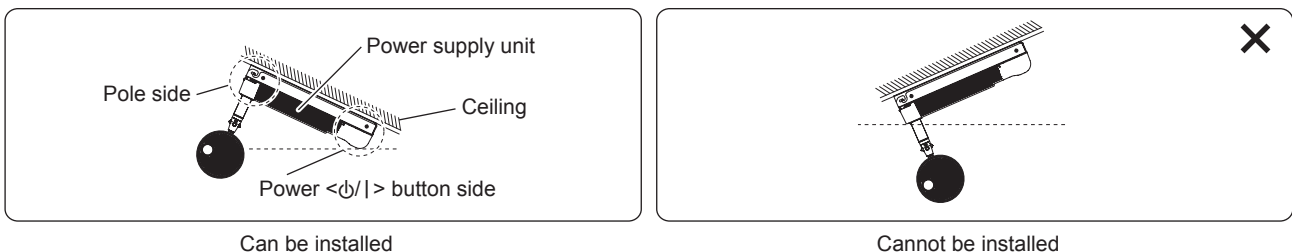

■ **When using the projector in combination with the optional Floor Stand Kit, install on a horizontal surface.**

■ **When using the projector in combination with the optional Floor Stand Kit, use the power cord supplied with the optional accessories, and ground at the outlet side.**

■ **Focus adjustment**

The projection lens is thermally affected by the light from the light source, making the focus unstable in the period just after switching on the power. It is recommended that images be projected continuously for at least 30 minutes before the focus is adjusted.

■ **Cautions when setting up the projector**

- Do not block the ventilation ports (intake and exhaust) of the projector.

- Prevent hot and cool air from the air conditioning system to blow directly to the ventilation ports (intake and exhaust) of the projector.

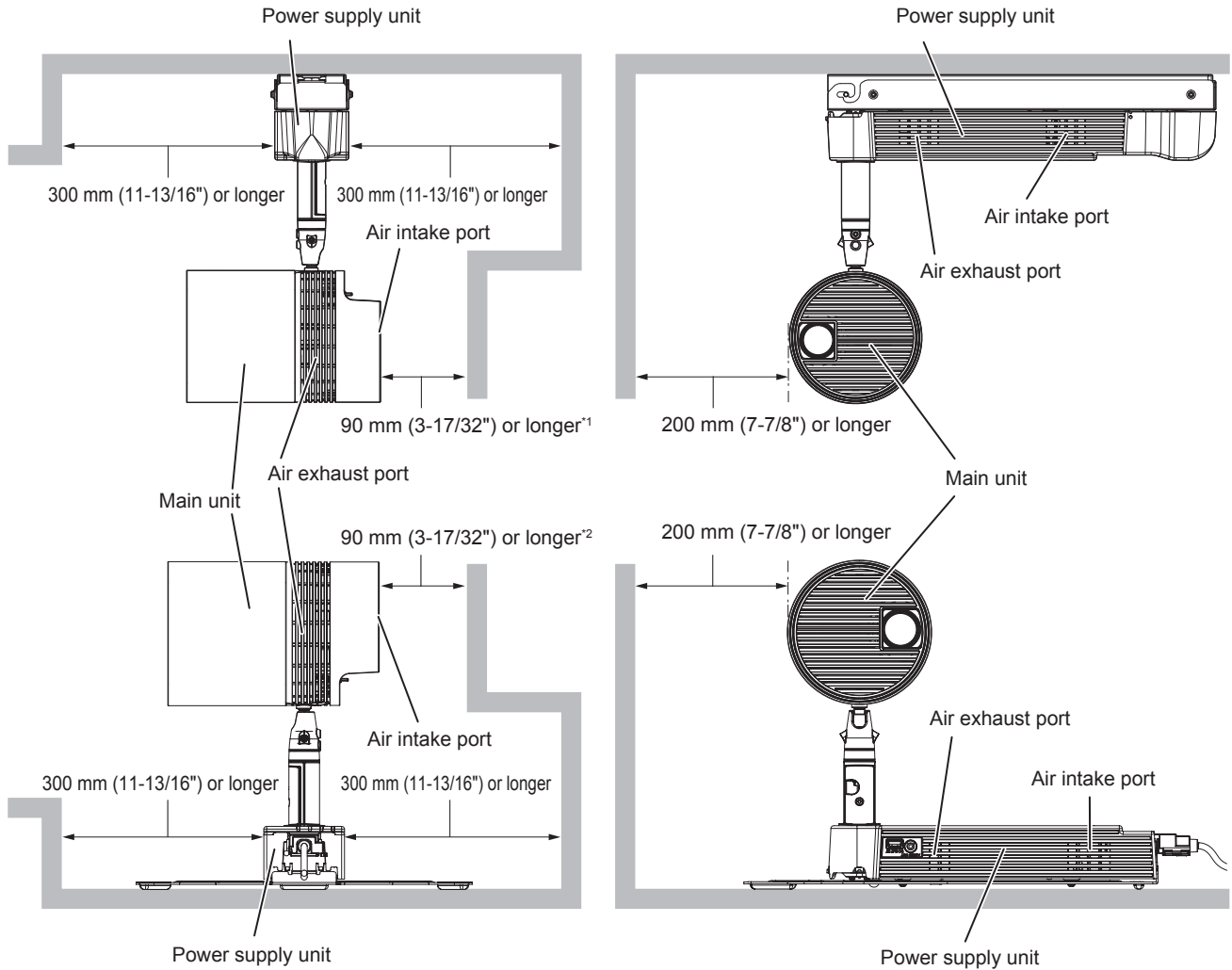

*1 Distance from the wall or ceiling surface which will cover the whole air intake port

*2 Distance from the wall or floor surface which will cover the whole air intake port

- Do not install the projector in a confined space.

When installing the projector in a confined space, provide air conditioning or ventilation separately. Exhaust heat may accumulate when the ventilation is not enough, triggering the protection circuit of the projector.

Cautions when transporting

- Before transporting, tighten the rotating fixing screw and ball joint fixing screws (2 locations) using the supplied Allen wrench (opposite side size 3.0 mm (1/8")). Transporting while they are loose may cause the fingers to be caught in between or malfunction.
- When the optional Floor Stand Kit is used, hold the bottom of the floor stand attached to the projector, and handle so that excessive vibration or shock is not applied when transporting. Failure to do so may damage the internal components and result in malfunctions.

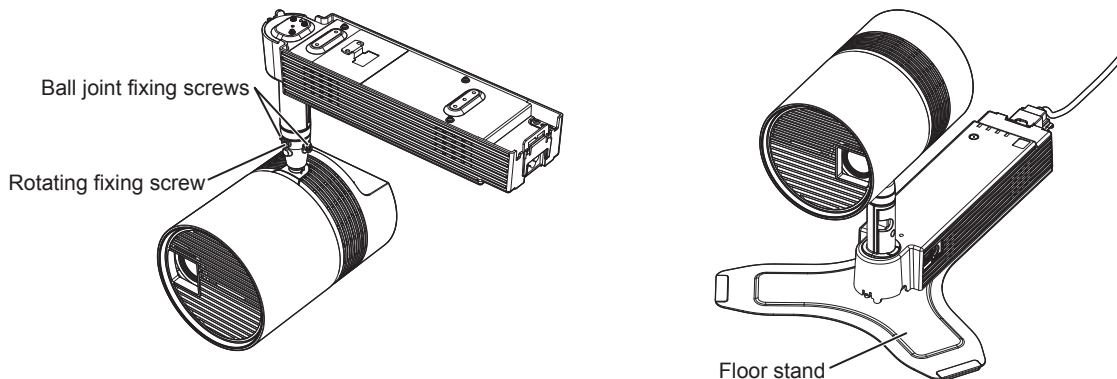

Security

When using this product, take safety measures against the following incidents.

- Personal information being leaked via this product
- Unauthorized operation of this product by a malicious third party
- Interfering or stopping of this product by a malicious third party

Take sufficient security measures. (➔ pages 90, 121)

- Make your password difficult to guess as much as possible.
- Change your password periodically.
- Panasonic Corporation or its affiliate companies will never ask for your password directly. Do not divulge your password in case you receive such inquiries.
- The connecting network must be secured by a firewall, etc.
- Set a password for the web control and restrict the users who can log in.

■ Security when using the wireless LAN product

The advantage of a wireless LAN is that information can be exchanged between a PC or other such equipment and a wireless access point using radio waves, instead of using a LAN cable, as long as you are within range for radio transmissions.

On the other hand, because the radio waves can travel through obstacles (such as walls) and are available everywhere within a given range, problems of the type listed below may occur if security settings are insufficient.

- Transmitted data may be intercepted

A malicious third-part may intentionally intercept radio waves and monitor the following transmitted data.

- Personal information such as your ID, password, credit card number
- Content of an Email

- Illegally accessed

A malicious third party may access your personal or corporate network without authorization and engage in the following types of behavior.

- Retrieve personal and/or secret information (information leak)
- Spread false information by impersonating a particular person (spoofing)
- Overwrite intercepted communications and issue false data (tampering)
- Spread harmful software such as a computer virus and crash your data and/or system (system crash)

Since most wireless LAN adapters or access points are equipped with security features to take care of these problems, you can reduce the possibility of these problems occurring when using this product by making the appropriate security settings for the wireless LAN device.

Some wireless LAN devices may not be set for security immediately after purchase. To decrease the possibility of occurrence of security problems, be sure to make all security related settings according to the operation instructions supplied with each wireless LAN device before using a wireless LAN device.

Depending on the specifications of the wireless LAN, a malicious third party may be able to break security settings by special means.

Panasonic asks customers to thoroughly understand the risk of using this product without making security settings, and recommends that the customers make security settings at their own discretion and responsibility.

Notes regarding the wireless LAN

Radio wave in the 2.4 GHz/5 GHz band is used when the wireless LAN connection function of the projector is used. The license of wireless station is not required, but understand the following when using.

■ Do not use close to other wireless devices.

Following devices may be using radio wave in the same bandwidth as the projector. Using the projector close to these devices may cause the communication to be disabled or the communication speed to slow down due to interference of radio wave.

- Microwave oven, etc.
- Industrial, scientific, or medical devices, etc.
- In-plant wireless station for identifying moving vehicles used in the manufacturing lines at a plant
- Specified low power wireless station

■ **Do not use cell phone, television, or radio as much as possible close to the projector.**

Cell phone, television, or radio is using radio wave with different bandwidth from the projector, so there is no effect on the wireless LAN communication or the send/receive on these devices. However, noise may occur in the audio or video due to the radio wave from the projector.

■ **Radio wave for wireless LAN communication does not go through the reinforcing bars, metal, or concrete.**

The projector can communicate through wall or floor made of wood or glass (excluding the glass with metal mesh embedded), but it cannot communicate through wall or floor made of reinforcing bars, metal, or concrete.

■ **Do not use the projector as much as possible in a location where static electricity is generated.**

The communication via wireless LAN or wired LAN may be prone to disruption when the projector is used in a location where static electricity or noise is generated.

There is a rare case that the LAN connection may not be established due to static electricity or noise. In such case, turn off the power with the power button on the remote control or the power supply unit of the projector, remove the source of problematic static electricity or noise, and turn the power of the projector back on.

■ **Using the projector outside the country**

It is forbidden to take the projector outside the country or region where you purchased it, so use it only in the country or region where you purchased it. Also, note that depending on countries or regions, there are restrictions on the channels and frequencies at which you can use the wireless LAN.

■ **Available wireless LAN channels**

The channels (frequency range) that can be used differ according to the country or region.

Please use the wireless LAN feature in compliance with the laws of each country.

Country or region	Standard	Channels used	Frequency band (Center frequency)
North America	IEEE802.11b/g/n	1 to 11	2.412 GHz - 2.462 GHz
	IEEE802.11a/n	36 / 40 / 44 / 48	5.180 GHz - 5.240 GHz
		52 / 56 / 60 / 64	5.260 GHz - 5.320 GHz
		100 / 104 / 108 / 112 / 116 / 132 / 136 / 140	5.500 GHz - 5.700 GHz (except 5.600 GHz - 5.650 GHz)
		149 / 153 / 157 / 161 / 165	5.745 GHz - 5.825 GHz
Other countries	IEEE802.11b/g/n	Passive scanning*1	2.412 GHz - 2.472 GHz
	IEEE802.11a/n	Passive scanning*1	5.180 GHz - 5.825 GHz

*1 The passive scanning is performed by changing radio to the channel being scanned in each country.

■ **This device is restricted to indoor use when operated in the 5.15 to 5.35 GHz frequency range (Channels 36 to 64).**

Art-Net

“Art-Net” is an Ethernet communication protocol based on the TCP/IP protocol.

By using the DMX controller and the application software, illumination and stage system can be controlled. Art-Net is made based on DMX512 communication protocol.

Cautions on use

■ **To get a good picture quality**

- In order to view a beautiful image in higher contrast, prepare an appropriate environment. Draw curtains or blinds over windows and turn off any lights near the projection surface to prevent outside light or light from indoor lamps from shining onto the projection surface.

- The projection lens of the projector is thermally affected by the light from the light source, making the focus unstable in the period just after switching on the power. The focus will stabilize after projection for more than 30 minutes has elapsed.

■ Do not touch the surface of the projection lens with your bare hands.

The finger print or dirt on the projection lens surface may be projected enlarged to the projection surface.

■ DLP chips

- The DLP chips are precision-made. Note that in rare cases, pixels of high precision could be missing or always lit. Note that such phenomenon does not indicate malfunction.
- Directing a high-power laser beam onto the projection lens surface can damage the DLP chip.

■ Light source

Laser is used as the light source of the projector, and it has the following characteristics.

- The luminance of the light source will decrease by duration of usage.
The time of usage for the luminance of the light source to become half is approximately 20 000 hours. 20 000 hours is the estimated duration, and it varies depending on individual differences and usage conditions.
If the light source goes off or the brightness reduces noticeably, ask your dealer about replacement of the light source unit.

■ Computer and external device connections

When connecting a computer or an external device, read related section of this document including the use of power cords and shielded cables.

Disposal

To dispose of the product, ask your local authorities or dealer for correct methods of disposal.

Accessories

Make sure that the following accessories are provided with your projector. Numbers enclosed in < > show the number of accessories.

Wireless remote control unit <1>
(N2QAYA000092)

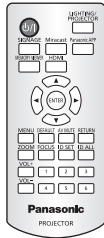

Connector secure lock <1>
(TTRA0185)

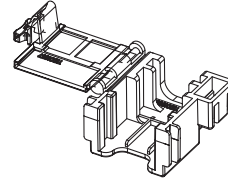

Card slot cap <1>
(TKKL5574)

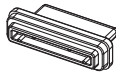

(Attached to the projector at the time of purchase)

AAA/R03 or AAA/LR03 battery <2>

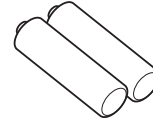

(For remote control unit)

HDMI terminal cap <1>
(TKKL5575)



(Attached to the projector at the time of purchase)

CD-ROM <1>
(1JK1JW130FE)



LAN terminal cap <1>
(TKKL5576)



(Attached to the projector at the time of purchase)

Allen wrench <1>
(Opposite side size 3.0 mm (1/8"))
(TXFQB03VLP4)

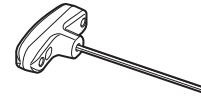

Attention

- After unpacking the projector, discard the packaging material properly.
- For missing accessories, consult your dealer.
- Store small parts in an appropriate manner, and keep them away from small children.

Note

- The optional Connector secure lock is used together with the Ceiling Kit or the Floor Stand Kit. Take care not to lose it.
- The model numbers of accessories are subject to change without prior notice.

Contents of the supplied CD-ROM

The contents of the supplied CD-ROM are as follows.

Instruction/list (PDF)	Operating Instructions – Functional Manual	
	Multi Projector Monitoring & Control Software Operating Instructions (English only)	
	Wireless Manager ME6.2 Operating Instructions (English only)	
	List of Compatible Device Models	This is a list of projectors that are compatible with the software contained in the CD-ROM and their restrictions.
	Software license	The license condition for the open source software used in the projector is contained as a PDF file.
Software	Multi Projector Monitoring & Control Software (Windows)	This software allows you to monitor and control multiple projectors connected to the LAN.
	Wireless Manager ME6.2 (Windows/Mac)	This software allows you to send the computer screen via wireless LAN/wired LAN.

Optional accessories

Optional accessories (product name)	Model No.	Outer color	Usage
Ceiling Kit	ET-JPC100WE	White*1	Dedicated fixture necessary to use the projector mounted directly to a ceiling.
	ET-JPC100BE	Black*2	
Floor Stand Kit	ET-JPF100WE	White*1	Dedicated fixture necessary to use the projector set on a floor or flat surface.
	ET-JPF100BE	Black*2	

*1 Used in combination with PT-JW130FWE.

*2 Used in combination with PT-JW130FBE.

Attention

- Use the projector in combination with the optional Ceiling Kit or Floor Stand Kit.

Note

- The model numbers of optional accessories are subject to change without prior notice.

About your projector

Remote control

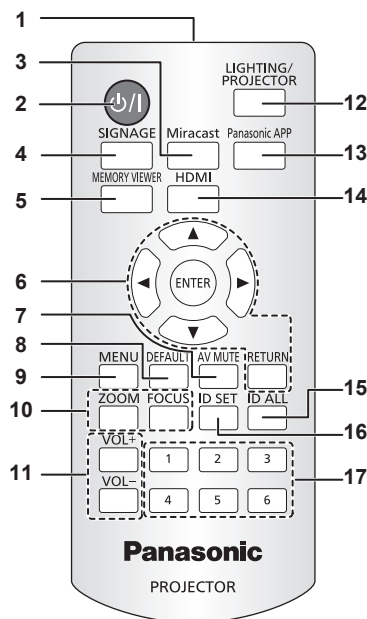

- 1 Remote control signal transmitter**
- 2 Power <Power> button**
Turns on/off the power of the projector. (➔ page 41)
- 3 <Miracast> button**
Switches the input to Miracast. (➔ page 47)
When you press this button during the lighting mode, the mode is switched to the projector mode, and the input is switched to Miracast.
- 4 <SIGNAGE> button**
Switches the input to signage. (➔ page 47)
When you press this button during the lighting mode, the mode is switched to the projector mode, and the input is switched to signage.
- 5 <MEMORY VIEWER> button**
Switches the input to Memory Viewer. (➔ page 47)
When you press this button during the lighting mode, the mode is switched to the projector mode, and the input is switched to Memory Viewer.
- 6 ▲▼◀▶ buttons/<ENTER> button/<RETURN> button**
Used to operate the menu screen. Also used when entering [SECURITY PASSWORD].
- 7 <AV MUTE> button**
Used to turn off the image and audio temporarily. (➔ page 52)
- 8 <DEFAULT> button**
Resets the settings of the sub-menu to the factory defaults. (➔ page 56)
- 9 <MENU> button**
Displays the main menu. (➔ page 55)
- 10 <ZOOM> button/<FOCUS> button**
Displays the lens menu and adjusts the projection lens. (➔ page 48)
- 11 <VOL+>/<VOL-> buttons**
Adjusts the volume of audio output. (➔ page 52)
- 12 <LIGHTING/PROJECTOR> button**
Switches the projection mode of the projector to lighting mode or projector mode. (➔ page 47)
- 13 <Panasonic APP> button**
Switches the input to Panasonic APPLICATION. (➔ page 47)
When you press this button during the lighting mode, the mode is switched to the projector mode, and the input is switched to Panasonic APPLICATION.
- 14 <HDMI> button**
Switches the input to HDMI. (➔ page 47)
When you press this button during the lighting mode, the mode is switched to the projector mode, and the input is switched to HDMI.
- 15 <ID ALL> button**
Used to simultaneously control all the projectors with a single remote control in a multiple projector environment. (➔ page 28)
- 16 <ID SET> button**
Sets the ID number of the remote control in a multiple projector environment. (➔ page 28)
- 17 Number (<1> - <6>) buttons**
Used in a multiple projector environment.
Used to enter ID number or password.

Attention

- Do not drop the remote control.
- Avoid contact with liquids or moisture.
- Do not attempt to modify or disassemble the remote control.
- Observe the following instructions that are indicated on the caution label at the back of the remote control:
 - Do not use a new battery together with an old battery.
 - Do not use unspecified batteries.

- Make sure the polarities (+ and –) are correct when inserting the batteries.
- For other instructions, read the instructions related to batteries that are described in “Read this first!”.

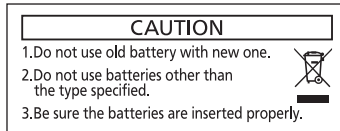

Caution label at the back of the remote control

Note

- The operating range of the remote control is approx. 7 m (22'11") when operated directly in front of the signal receiver. For the range that can be operated with the remote control, refer to “Operating range of the remote control” (➔ page 29).
- If there are any obstacles between the remote control and the remote control signal receiver, the remote control may not operate properly.
- The remote control may not operate properly if the remote control signal receiver on the power supply unit of the projector is directly receiving strong light, such as fluorescent light. Install the projector in a place distant from the light source.

Projector body

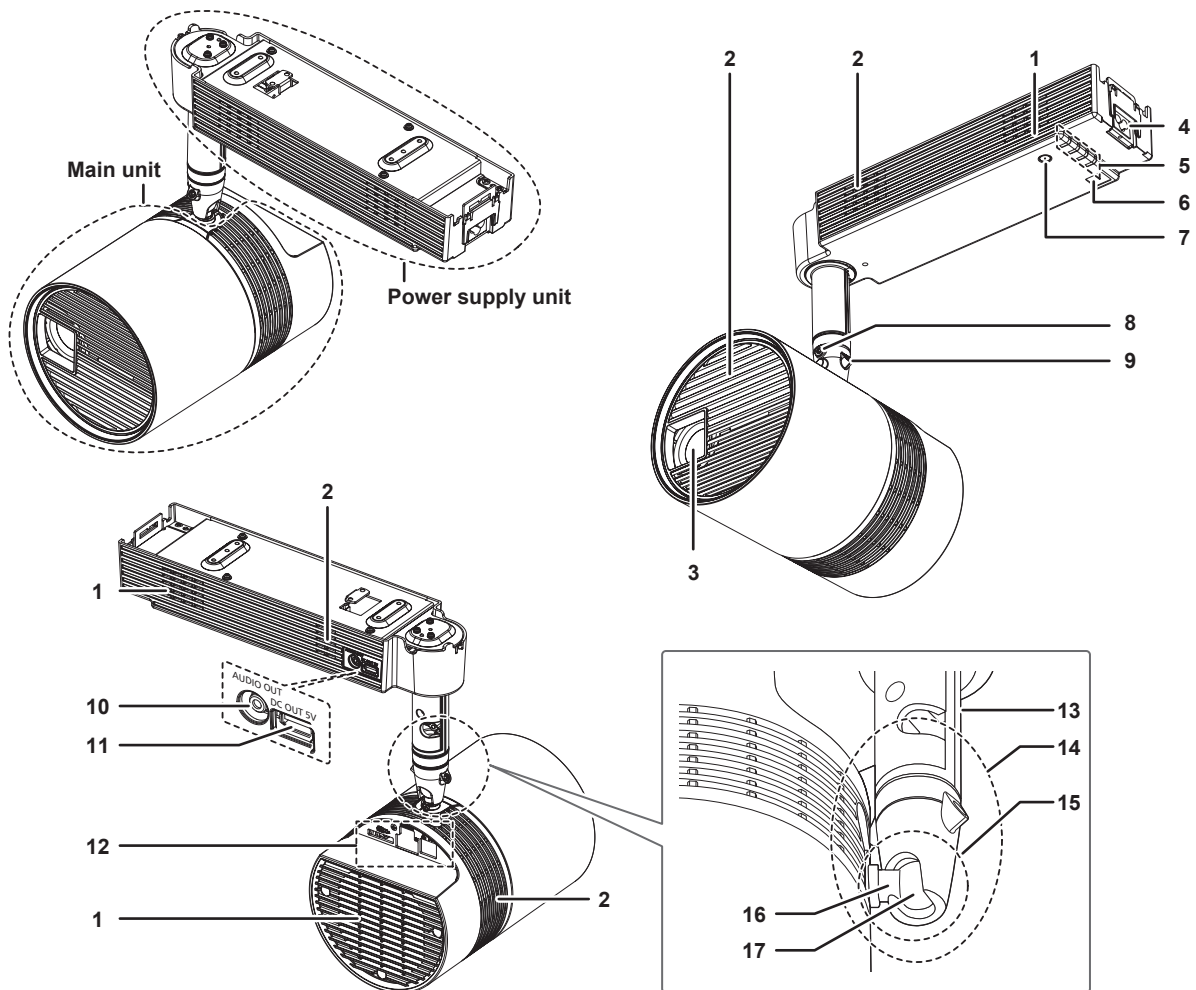

- | | |
|---|--|
| <p>1 Air intake port</p> <p>2 Air exhaust port</p> <p>3 Projection lens</p> <p>4 <AC IN> terminal
Connects the power cord attached to the optional Ceiling Kit, or the power cord supplied with the optional Floor Stand Kit.</p> <p>5 Indicators (➔ pages 27, 200)</p> <p>6 Remote control signal receiver</p> <p>7 Power <⏻/⏻> button
Turns on/off the power of the projector. (➔ page 41)</p> <p>8 Rotating fixing screw
Tightens and fixes the rotation of the shaft holder after adjusting the orientation of the main unit. (➔ page 36)</p> | <p>9 Ball joint fixing screws
Tightens and fixes the ball joint movable part after adjusting the orientation of the main unit. (➔ page 36)</p> <p>10 <AUDIO OUT> terminal
This is the terminal to output audio signal when a audio signal is input to the <HDMI IN> terminal and when the movie with audio in the SD card is played back. (➔ page 38)</p> <p>11 <DC OUT> terminal
This is the USB terminal only used for power supply. (DC 5 V, maximum of 900 mA)
This can be used when the power supply to a Bluetooth® audio transmitter, etc. is required.</p> <p>12 Connecting terminals (➔ pages 27, 38)</p> <p>13 Pole</p> <p>14 Shaft holder</p> |
|---|--|

15 Ball joint movable part

16 Shaft

17 Ball joint

■ Indicators

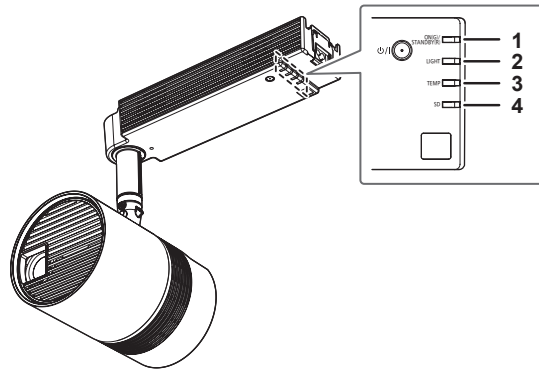

1 Power indicator <ON (G)/STANDBY (R)>
Displays the status of the power. (➔ page 41)

2 Light source indicator <LIGHT>
Displays the status of the light source. (➔ page 200)

3 Temperature indicator <TEMP>
Displays the internal temperature status. (➔ page 201)

4 SD card indicator <SD>
Blinks in green when accessing the SD card.

■ Connecting terminals

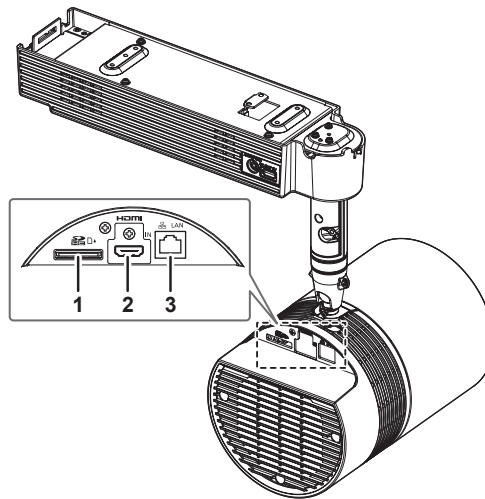

1 SD card slot
Supports SD memory card and SDHC memory card.
(➔ page 49)

2 <HDMI IN> terminal
This is the terminal to input HDMI signal. (➔ page 38)

3 <LAN> terminal
This is the terminal to connect to the network. (➔ page 38)

Attention

- The LAN cable connecting to the projector directly should be wired indoors only.
- Store small parts such as SD card in an appropriate manner, and keep them away from small children.

Preparing the remote control

Inserting and removing the batteries

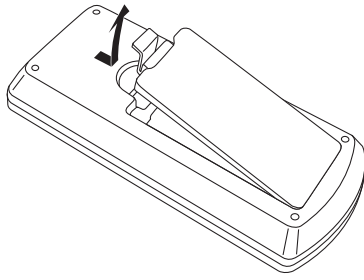

Fig. 1

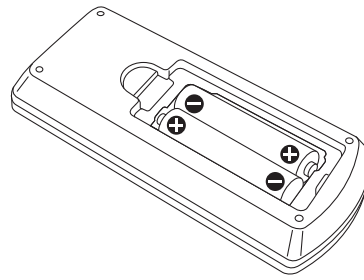

Fig. 2

- 1) **Open the cover. (Fig. 1)**
- 2) **Insert the batteries and close the cover (insert the \ominus side first). (Fig. 2)**
 - When removing the batteries, perform the steps in reverse order.

When using the multiple projectors

When you use the multiple projectors together, you can control all the projectors simultaneously or each projector individually using single remote control, if a unique ID number is assigned to each projector.

When using the projectors by setting the ID numbers, set the ID number of the projector body after initial settings have been completed. Then, set the ID number of the remote control.

For initial settings, refer to “When the initial setting screen is displayed” (➔ page 42).

The factory default ID number of the projector (projector body and remote control) is set to [ALL], so you can use it as it is. Set the ID numbers of the projector body and remote control as necessary.

For details on setting the ID number of the remote control, refer to “Setting the remote control ID numbers” (➔ page 52).

Note

- Set the ID number of the projector body from the [SETUP] menu → [PROJECTOR ID].

Operating range of the remote control

The operating range of the remote control is maximum of approximately 7 m (22'11") in front of the remote control signal receiver and within the range shown in the following illustration.

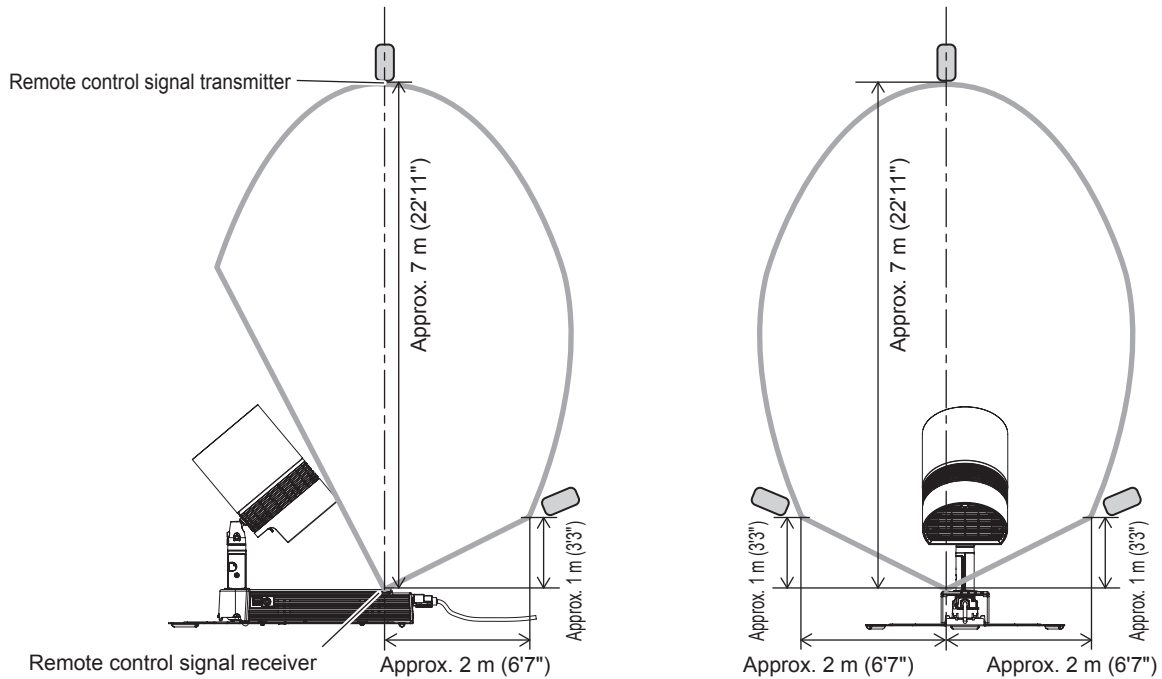

Note

- Above illustration is an usage example when standing the projector on the floor. It is not in accurate scale. The operating range when installed in a ceiling is the same.
- If there are any obstacles between the remote control and the remote control signal receiver, including the main unit of the projector, the remote control may not operate properly.
- The remote control may not operate properly if the remote control signal receiver on the power supply unit of the projector is directly receiving strong light, such as fluorescent light. Install the projector in a place distant from the light source.

Chapter 2 **Getting Started**

This chapter describes things you need to do before using the projector such as the setup and connections.

Before the installation

This section describes the display method using the projector.

Projection mode

The projection mode of the projector can be switched to the lighting mode to use the projector as a spot light, or to the projector mode to project an image by pressing the <LIGHTING/PROJECTOR> button on the remote control. (➔ page 47)

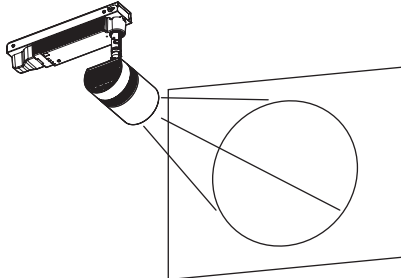

Lighting mode (example)

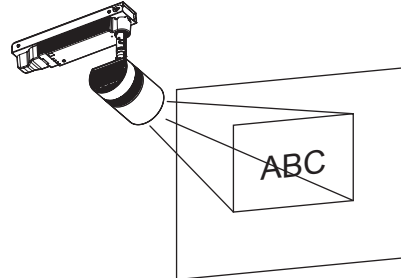

Projector mode (example)

Installation method

The projector can be installed in two methods of ceiling mount and floor standing depending on the combination of the optional accessories. Purchase the optional accessories depending on the installation method. The Ceiling Kit (Model No.: ET-JPC100WE, ET-JPC100BE) is required for ceiling mounting installation, and the Floor Stand Kit (Model No.: ET-JPF100WE, ET-JPF100BE) is required for floor standing installation.

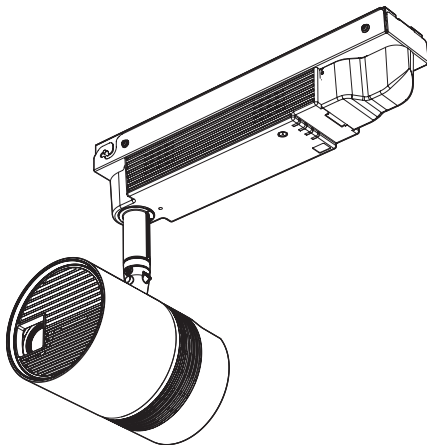

Installation example when installing on the ceiling

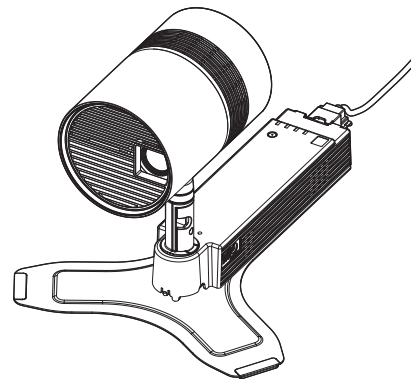

Installation example when standing on the floor

Installation form

There are total of four installation forms: two for the projection method and two for the display direction, for each of two installation methods, when using the projector in the projector mode. Set the [SETUP] menu → [PROJECTION METHOD] (➔ page 68) and [VERTICAL FLIP] (➔ page 68) depending on the installation form in combination with the optional accessories.

■ Installation form when installing on the ceiling

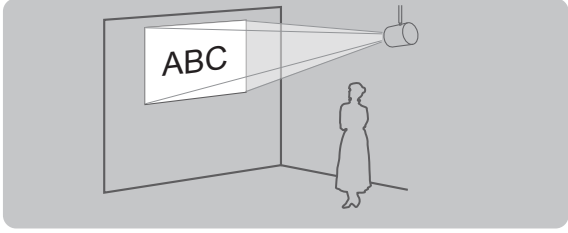
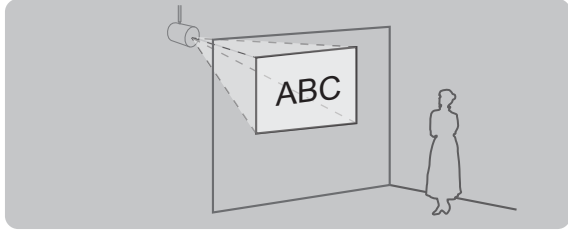
To project forward		To project from rear (Using the translucent screen)	
			
Menu item	Method	Menu item	Method
[PROJECTION METHOD]	[FRONT]	[PROJECTION METHOD]	[REAR]
[VERTICAL FLIP]	[OFF]	[VERTICAL FLIP]	[OFF]

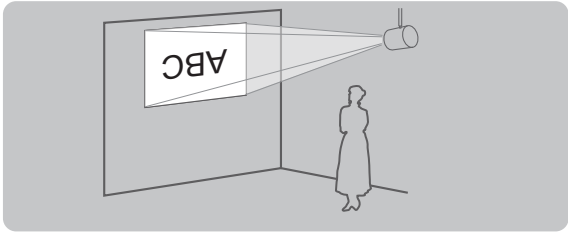
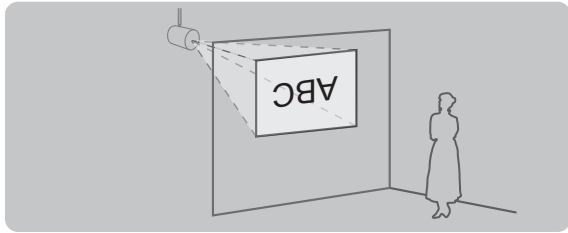
To project forward		To project from rear (Using the translucent screen)	
			
Menu item	Method	Menu item	Method
[PROJECTION METHOD]	[FRONT]	[PROJECTION METHOD]	[REAR]
[VERTICAL FLIP]	[ON]	[VERTICAL FLIP]	[ON]

■ Installation form when standing on the floor

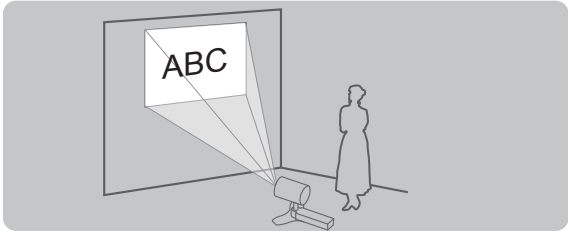
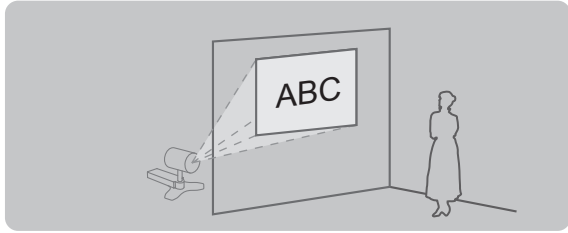
To project forward		To project from rear (Using the translucent screen)	
			
Menu item	Setting value	Menu item	Setting value
[PROJECTION METHOD]	[FRONT]	[PROJECTION METHOD]	[REAR]
[VERTICAL FLIP]	[ON]	[VERTICAL FLIP]	[ON]

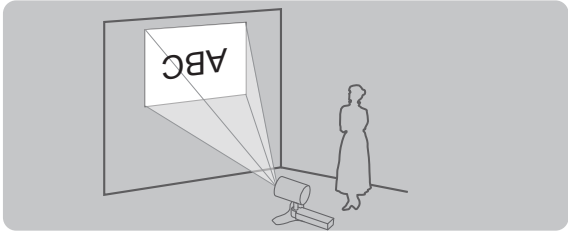
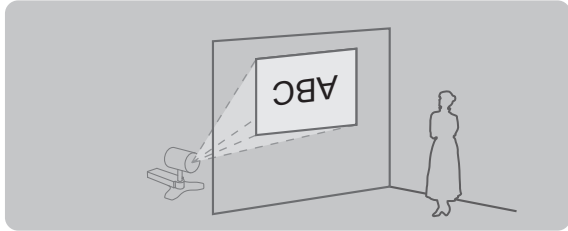
To project forward		To project from rear (Using the translucent screen)	
			
Menu item	Setting value	Menu item	Setting value
[PROJECTION METHOD]	[FRONT]	[PROJECTION METHOD]	[REAR]
[VERTICAL FLIP]	[OFF]	[VERTICAL FLIP]	[OFF]

Note

- Above illustrations for installation form are examples for explanation, and it may not be the actual condition of usage. Set the [SETUP] menu → [PROJECTION METHOD] (➡ page 68) and the [VERTICAL FLIP] (➡ page 68) according to the environment of the usage and the direction of the main unit.

Projection direction

When using the projector in the projector mode, various expressions are possible by combination of adjustment of the direction of the main unit as described in “Adjusting the projection position” (➡ page 36) and the settings of the [SETUP] menu → [PROJECTION METHOD] (➡ page 68) and the [VERTICAL FLIP] (➡ page 68). The direction of irradiation can be adjusted freely in similar manner when using the projector in the lighting mode. Following illustration is an example when [PROJECTION METHOD] is set to [FRONT], and [VERTICAL FLIP] is set to [OFF] for ceiling mount installation.

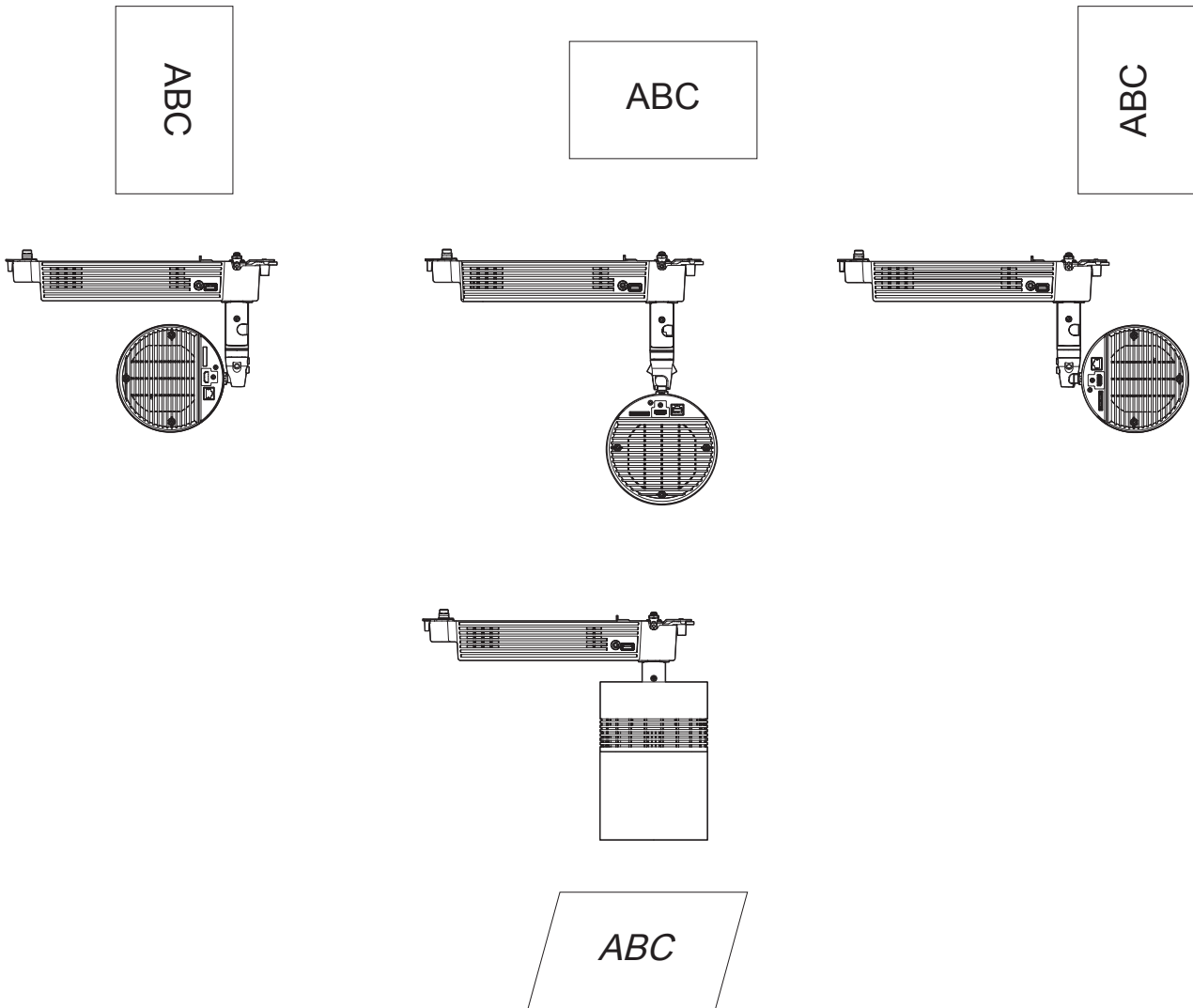

Projection dimensions

Decide the installation position on the ceiling or the installation position on the floor referencing to the following illustrations and projection distance dimensions. The size and position of the projected image can be adjusted according to the area and position of the projection surface.

■ When installing on the ceiling

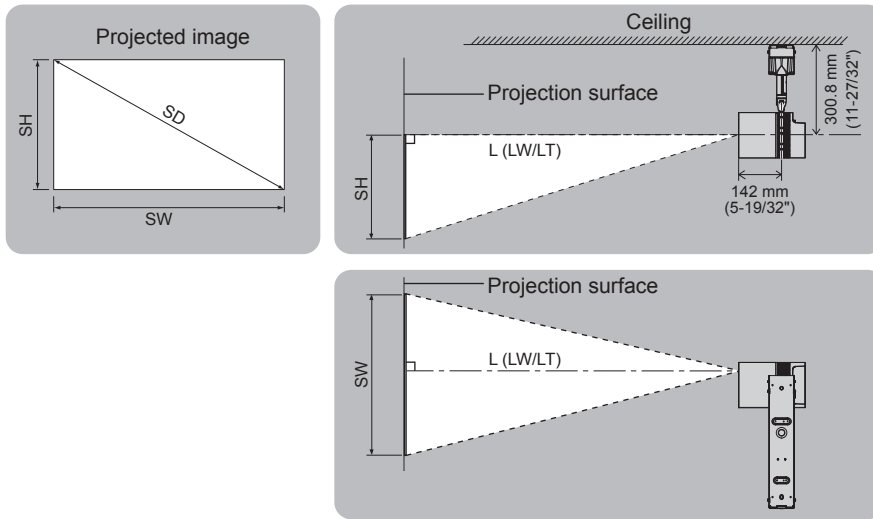

■ When standing on the floor

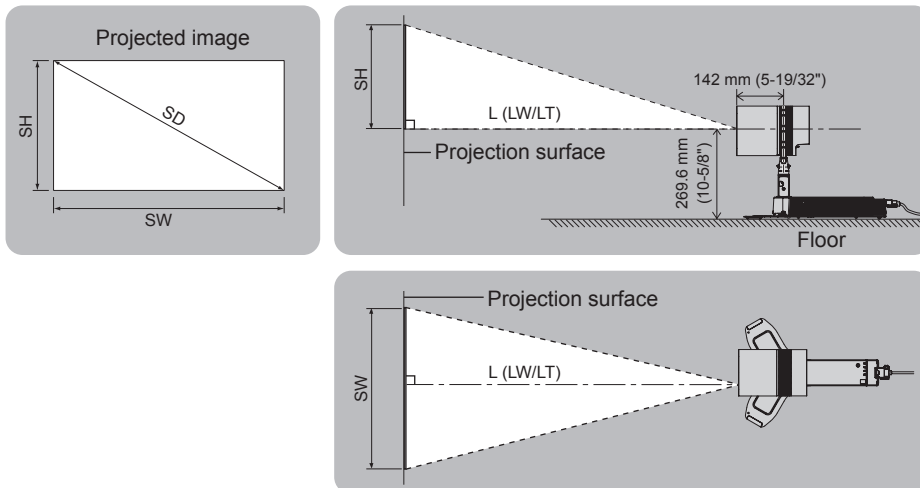

L (LW/LT)*1	Projection distance (distance from the projection lens surface to the projection surface) (m)
SH	Image height (m)
SW	Image width (m)
SD	Image diagonal size (m)

*1 LW: Minimum projection distance
LT: Maximum projection distance

Attention

- Before setting up, read "Precautions for use" (➔ page 17).
- Do not use the projector and the high-power laser equipment in the same room. The DLP chip can be damaged if a laser beam hits the lens surface.

Projection distance

The dimension in the following table contains a slight error.

Also, it is corrected to become smaller than the specified image size when [KEYSTONE] is used.

■ When the image aspect ratio is 16:10

(Unit: m)

Diagonal (SD)	Projected image size		Projection distance (L)	
	Height (SH)	Width (SW)	Min. (LW)	Max. (LT)
0.76 (30")	0.404	0.646	0.95	2.10
1.02 (40")	0.538	0.862	1.28	2.81
1.27 (50")	0.673	1.077	1.61	3.52
1.52 (60")	0.808	1.292	1.94	4.23
1.78 (70")	0.942	1.508	2.27	4.94
2.03 (80")	1.077	1.723	2.60	5.65
2.29 (90")	1.212	1.939	2.93	6.36
2.54 (100")	1.346	2.154	3.26	7.07
3.05 (120")	1.615	2.585	3.92	8.50
3.81 (150")	2.019	3.231	4.91	10.63
5.08 (200")	2.692	4.308	6.55	14.19

Projection distance formula

To use an image size not listed in this manual, check the projected image size SD (m) and use the respective formula to calculate projection distance (L).

The unit of the formula is all "m". (Value obtained by the following calculation formula contains a slight error.)

When calculating a projection distance using image size designation (value in inches), multiply the value in inches by 0.0254 and substitute it into SD in the formula for calculating the projection distance.

■ When the image aspect ratio is 16:10

Minimum projection distance (LW)	$L = 1.2976 \times SD - 0.0385$
Maximum projection distance (LT)	$L = 2.7999 \times SD - 0.0379$

Setting up

Installing the projector

This projector is used in combination with the optional Ceiling Kit or Floor Stand Kit.

■ When installing on the ceiling

The optional Ceiling Kit is required to use the projector directly installed on a ceiling.

- Be sure to use the Ceiling Kit specified for this projector.
- For installation of the projector to a ceiling, refer to the Installation Instructions of the Ceiling Kit.

Attention

- To ensure projector performance and security, be sure to ask your dealer or a building electrician for installing the projector to the ceiling.

■ When standing on the floor

The optional Floor Stand Kit is required to use the projector set on the floor.

- Be sure to use the Floor Stand Kit specified for this projector.
- For installation of the Floor Stand Kit to the projector, refer to the Operating Instructions of the Floor Stand Kit.
- After installing the Floor Stand Kit, install the projector referencing “Projection dimensions” (➔ page 34).

Adjusting the projection position

Adjust the orientation of the main unit to adjust the projection position after installing the projector.

1) Loosen the fixing screws.

- Loosen the rotating fixing screw and ball joint fixing screws (2 locations) using the supplied Allen wrench (opposite side size 3.0 mm (1/8")).

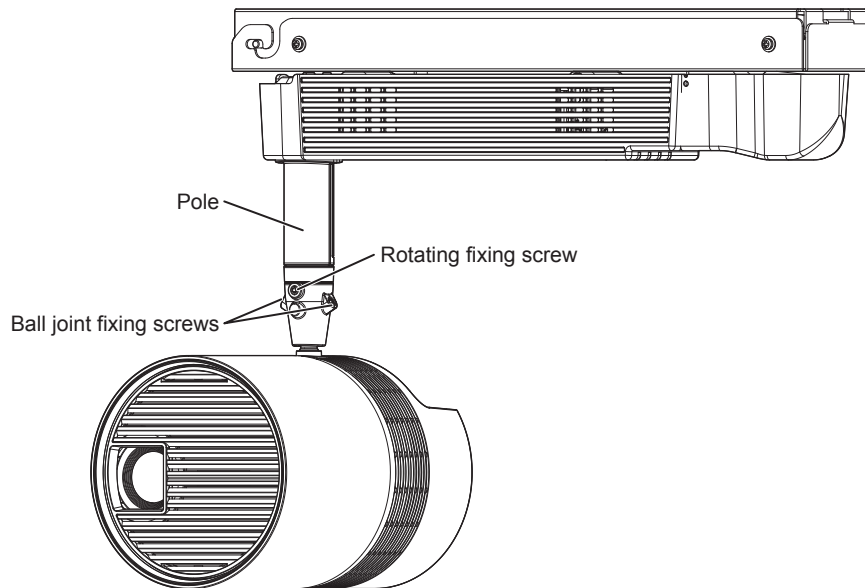

2) Adjust the orientation of the main unit.

- Adjust the ball joint movable part to the direction to tilt the main unit, and adjust the orientation of the main unit.

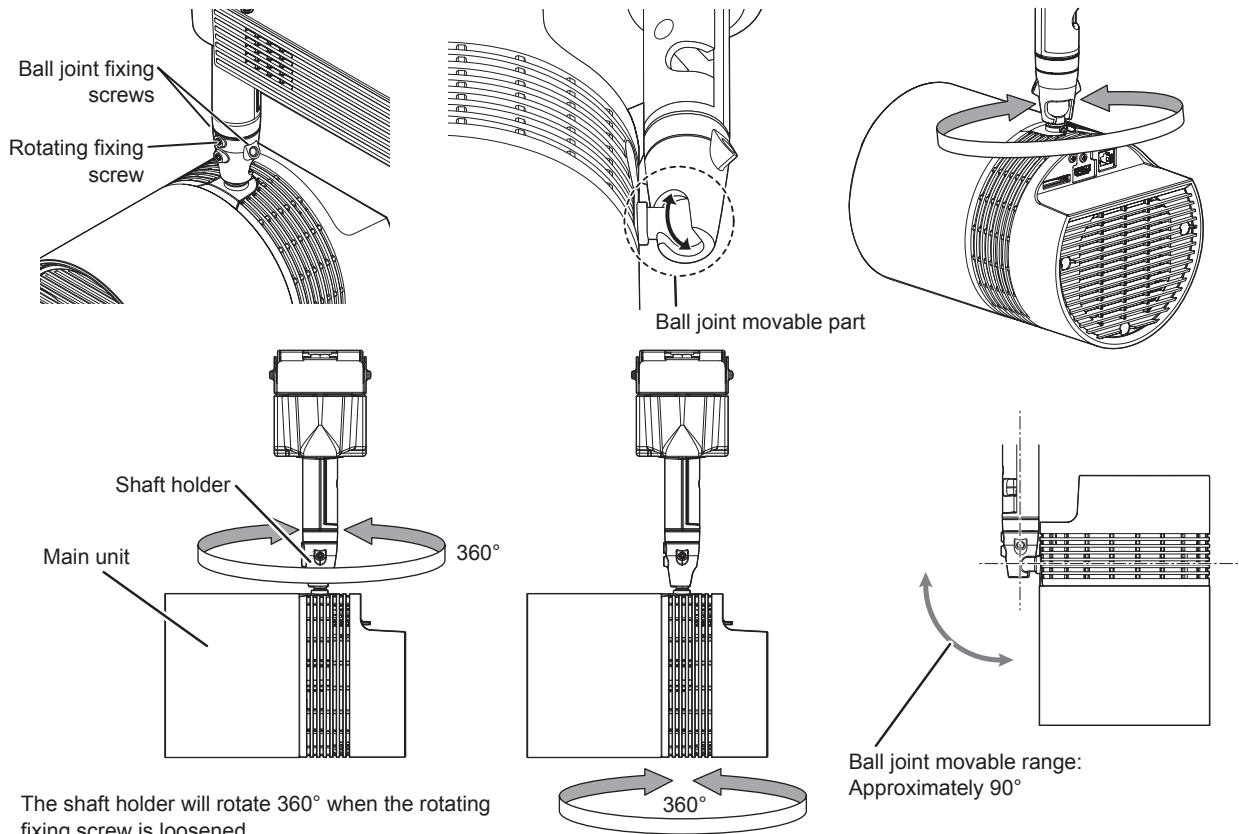

The shaft holder will rotate 360° when the rotating fixing screw is loosened. Move the ball joint movable part to the direction to tilt the main unit.

The ball joint will become free when the ball joint fixing screws (2 locations) are loosened. The main unit can be rotated 360° or the main unit can be tilted 90° at the ball joint movable part.

3) Tighten the fixing screws.

- While supporting the main unit, securely tighten the rotating fixing screw and ball joint fixing screws (2 locations) using the supplied Allen wrench (opposite side size 3.0 mm (1/8")).

Attention

- The main unit and the power supply unit are connected with cables, etc. Do not rotate or tilt the main unit more than necessary.

Note

- After adjusted roughly, fine adjust the projection position while projecting.
- The rotating fixing screw and the ball joint fixing screws are hexagonal socket head fixing screws (M6). Note that they will come off the projector if they are loosened too much.
- Note that your hand may get caught in between the pole and the main unit when the pole joint fixing screw is loosened while holding the pole section when setting the projector on the floor.

Connecting

Before connecting

- Before connecting, carefully read the operating instructions for the external device to be connected.
- Turn off the power of all devices before connecting cables.
- Take note of the following points before connecting the cables. Failure to do so may result in malfunctions.
 - When connecting a cable to a device connected to the projector or the projector itself, touch any nearby metallic objects to eliminate static electricity from your body before performing work.
 - Do not use unnecessarily long cables to connect a device to the projector or to the projector body. The longer the cable, the more susceptible to noise it becomes. Since using a cable while it is wound makes it act like an antenna, it is more susceptible to noise.
 - When connecting cables, connect GND first, then insert the connecting terminal of the connecting device in a straight manner.
- Acquire any connection cable necessary to connect the external device to the system that is neither supplied with the device nor available as an option.
- Some computer models or graphics cards are not compatible with the projector.
- Use a cable compensator when you connect devices to the projector using long cables. Otherwise the image may not display properly.
- Only HDMI signals can be input to the projector. Refer to “List of compatible signals” (➔ page 215) for the types of video signals that can be used with the projector.

Connecting example: External devices

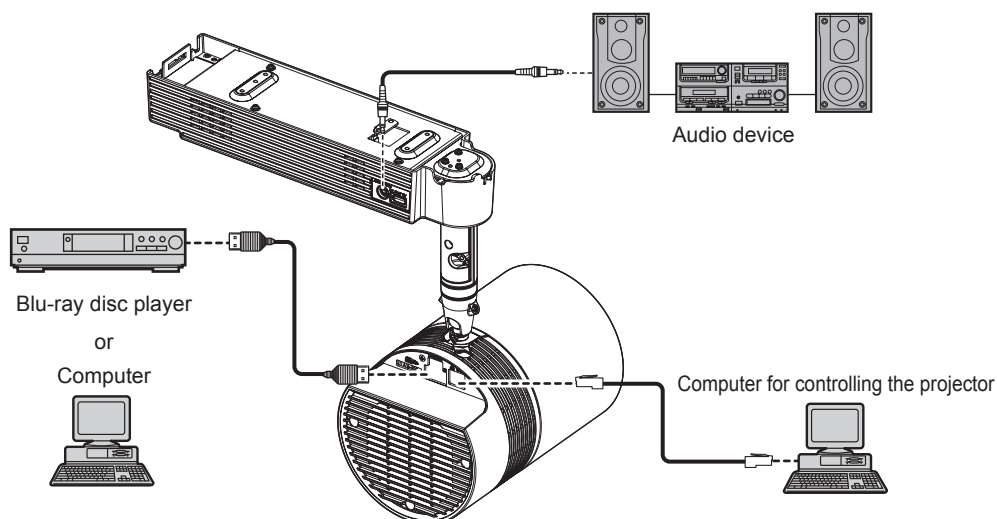

Attention

- When connecting the projector to a computer or an external device, use the power cord supplied with each device and commercially available shielded cables.

Note

- For an HDMI cable, use an HDMI High Speed cable that conforms to HDMI standards. If a cable that does not conform to HDMI standards is used, images may be interrupted or may not be displayed.
- The <HDMI IN> terminal of the projector can be connected to an external device with a DVI terminal by using an HDMI/DVI conversion cable, but the projector may not project the image properly or function properly with some devices.
- The projector does not support VIERA Link (HDMI).
- If you operate the projector using the computer with the resume feature (last memory), you may have to reset the resume feature to operate the projector.

Attaching the caps to the connecting terminals

It is recommended to attach the supplied terminal caps to the <HDMI IN> terminal and the <LAN> terminal where cables are not attached, and the supplied card slot cap to the SD card slot to prevent dust getting into the connecting terminals.

Before attaching the caps, check the shapes of the caps and the places to attach.

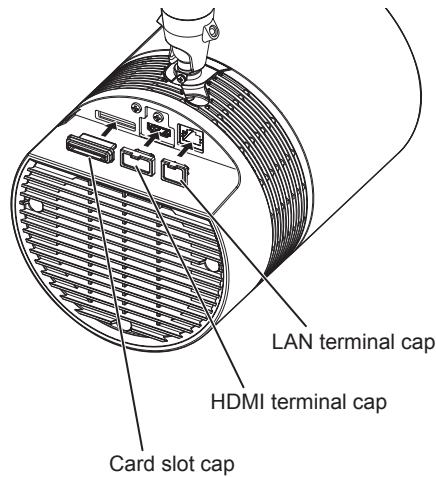

Note

- The card slot cap can be attached even when an SD card is inserted. The direction of attaching the card slot cap will differ as shown below depending on the existence of the SD card. Check the condition of the SD card slot and the direction of the card slot cap before attaching.

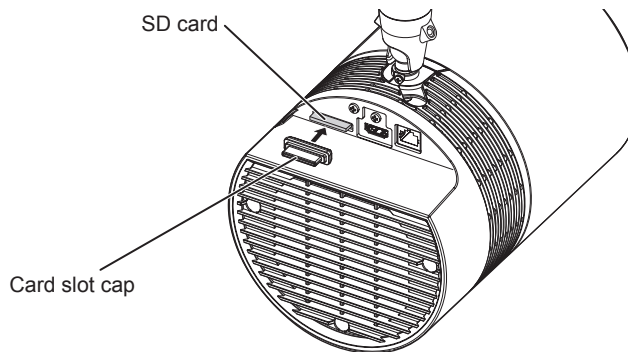

- Do not insert with excessive force when attaching the cap. Doing so may damage the terminal or the cap. Also, when attaching the card slot cap with the SD card inserted, the SD card will be in ejected state if it is pressed in too much.

Chapter 3 Basic Operations

This chapter describes basic operations to start with.

Turning on/off the projector

Power indicator

Indicates the status of the power. Check the status of the power indicator <ON (G)/STANDBY (R)> before operating the projector.

When the light source indicator <LIGHT> and the temperature indicator <TEMP> are lighting or blinking, a problem may have occurred inside the projector. Check the status of the indicator before turning on the projector, and take appropriate steps. (➔ page 200)

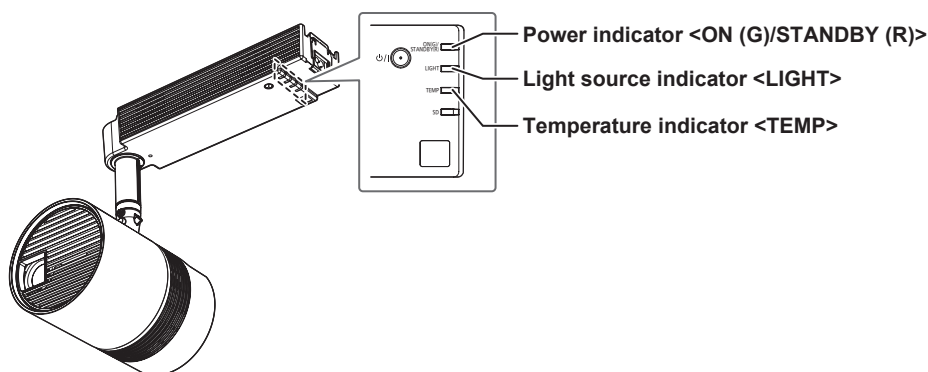

Indicator status		Projector status
Off		The power is not supplied to the projector. (The power supply to the interior wiring is turned off or the power cord is not connected to the outlet.)
Red	Lighting	The power is switched off. (standby mode) [STANDBY MODE] in the [SETUP] menu → [ECO MANAGEMENT] is set to [ECO]. Projection will start when the power <⏻/ > button is pressed. • The projector may not operate when the temperature indicator <TEMP> is blinking. (➔ page 200)
	Blinking*1	The power is switched off (in standby mode). [STANDBY MODE] in the [SETUP] menu → [ECO MANAGEMENT] is set to [NETWORK]. Projection will start when the power <⏻/ > button is pressed. • The projector may not operate when the temperature indicator <TEMP> is blinking. (➔ page 200)
	Blinking*2	The power is switched off (in standby mode). [STANDBY MODE] in the [SETUP] menu → [ECO MANAGEMENT] is set to [NORMAL]. Projection will start when the power <⏻/ > button is pressed. • The projector may not operate when the temperature indicator <TEMP> is blinking. (➔ page 200)
Green	Lighting	Projecting.

*1 The indicator will blink in frequency of lighting 2.75 seconds → off 0.25 seconds → lighting 0.75 seconds → off 0.25 seconds.

*2 The indicator will blink in frequency of lighting 2.75 seconds → off 0.25 seconds.

Note

- The projector consumes power even in standby mode (when the power indicator <ON (G)/STANDBY (R)> is lighting or blinking in red). Refer to "Power consumption" (➔ page 213) for the power consumption.
- The power indicator <ON (G)/STANDBY (R)> blinks in green if a remote control signal is received.
- The power indicator <ON (G)/STANDBY (R)> blinks slowly in green while the AV mute is in use.
- When the computer (including iPad/iPhone/iPod touch, Android terminals) performs a connection check on the projector using the Panasonic image transfer application software, the power indicator <ON (G)/STANDBY (R)> blinks in orange.

Turning on the projector

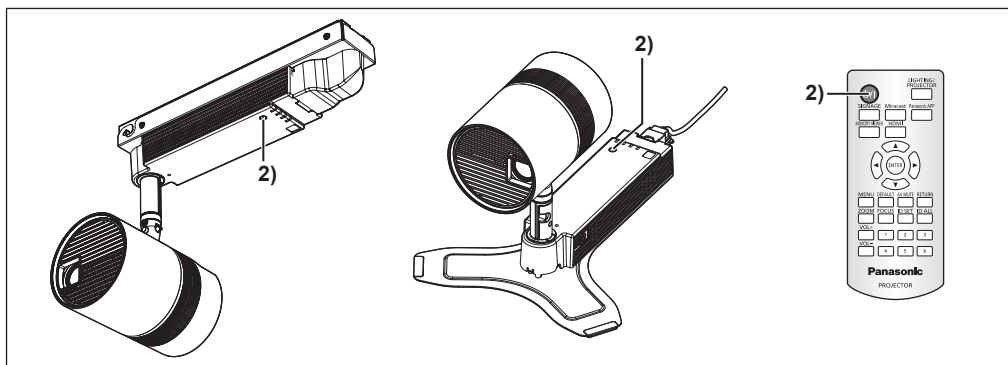

■ When using the optional Ceiling Kit

- 1) Turn on the power supply of the interior wiring that is connected to the projector.
 - The power indicator <ON (G)/STANDBY (R)> lights in red, and the projector enters the standby mode.
- 2) Press the power <⏻/|> button.
 - The power indicator <ON (G)/STANDBY (R)> lights in green and the projection is soon started.

■ When using the optional Floor Stand Kit

- 1) Connect the power cord connected to the projector to an outlet
 - The power indicator <ON (G)/STANDBY (R)> lights in red, and the projector enters the standby mode.
- 2) Press the power <⏻/|> button.
 - The power indicator <ON (G)/STANDBY (R)> lights in green, and the projection is soon started.

Attention

- When turning on the projector, take notice of the people around the projector and ensure the light from the light source will not flash into their eyes.

Note

- The initial setting screen is displayed when the projector is turned on for the first time after purchase or when [ALL USER DATA] in the [SETUP] menu → [INITIALIZE] is executed. Refer to “When the initial setting screen is displayed” (➡ page 42).
- The operating range of the remote control is approx. 7 m (22'11") when operated directly in front of the signal receiver. For the range that can be operated with the remote control, refer to “Operating range of the remote control” (➡ page 29).
- It may take longer for the projection to start when the [SETUP] menu → [ECO MANAGEMENT] → [STANDBY MODE] is set to [ECO] or [NETWORK] when compared set to [NORMAL].
- When the power is turned on or an input signal is switched, you may hear a high-frequency driving sound. This is not a malfunction.
- When the [SETUP] menu → [INITIAL STARTUP] is set to [LAST MEMORY], the power indicator <ON (G)/STANDBY (R)> lights in green and the projection is soon started when the projector was turned off by directly turning off the power supply of the interior wiring or disconnected the power plug from the outlet while projecting in previous use, and the power supply is turned on or the power plug is connected to the outlet again.

When the initial setting screen is displayed

The initial setting screen is displayed when the projector is turned on for the first time after purchase or when [ALL USER DATA] in the [SETUP] menu → [INITIALIZE] is executed. Set the following according to the circumstances. In other occasions, you can change the settings by menu operations.

If you press the <RETURN> button while the initial setting screen is displayed, you can go back to the previous screen.

Focus adjustment

Adjust the focus to display the menu screen clearly.

You may also need to adjust the zoom.

Refer to “Adjusting the projection” (➡ page 48) for details.

- 1) Press ▲▼◀▶ on the remote control to adjust the focus.

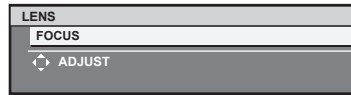

- 2) Press the <MENU> button on the remote control to perform rest of the initial setting.

Initial setting (display language)

Select the language to show on the screen.

After completed the initial setting, you can change the display language from the [DISPLAY LANGUAGE] menu.

- 1) Press ▲▼ on the remote control to select the display language.

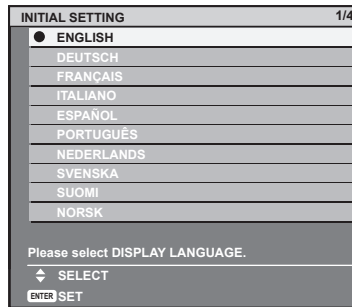

- 2) Press the <ENTER> button on the remote control to perform next initial setting.

Initial setting (installation setting)

Set [PROJECTION METHOD] and [VERTICAL FLIP] depending on the installation conditions. Refer to "Installation form" (➔ page 31) for details.

Set [HIGH ALTITUDE MODE] to [HIGH1] when using the projector at altitude between 1 000 m (3 281') and 2 000 m (6 562') above sea level, and set [HIGH ALTITUDE MODE] to [HIGH2] when using the projector at altitude between 2 000 m (6 562') and 2 700 m (8 858').

Once the initial setting is completed, the settings for each item can be changed from the [SETUP] menu.

- 1) Press ▲▼ on the remote control to select an item.
- 2) Press ◀▶ on the remote control to switch the setting.

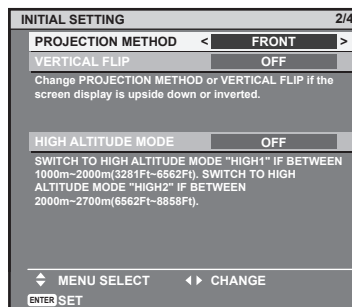

- 3) Press the <ENTER> button on the remote control to perform next initial setting.

Initial setting (standby mode)

Set the operation mode during the standby. The default setting is [ECO] that keeps power consumption low during standby. If you use the network function during standby, set to [NORMAL]. If you want to keep the power consumption low during standby, and to perform operation of power-on via wired LAN, set to [NETWORK]. Once the initial setting is completed, setting can be changed from the [SETUP] menu → [ECO MANAGEMENT] → [STANDBY MODE].

1) Press ◀▶ on the remote control to switch the setting.

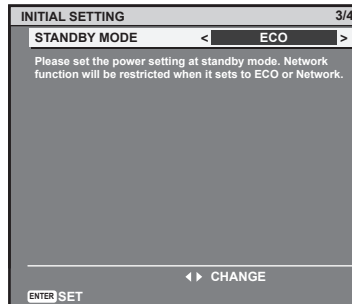

2) Press the <ENTER> button on the remote control to perform next initial setting.

Note

- The above initial setting screen is the one displayed when the projector is turned on for the first time after purchase. When [ALL USER DATA] is executed from the [SETUP] menu → [INITIALIZE], the [STANDBY MODE] setting before the execution is displayed.

Initial setting (time zone)

Set [TIME ZONE] according to the country or region where the projector is used.

Once the initial setting is completed, setting can be changed from the [SETUP] menu → [DATE AND TIME].

The current settings are displayed in the [LOCAL DATE] and the [LOCAL TIME]. If a change is necessary, set with the [SETUP] menu → [DATE AND TIME] after completing the initial setting.

1) Press ◀▶ on the remote control to switch the setting.

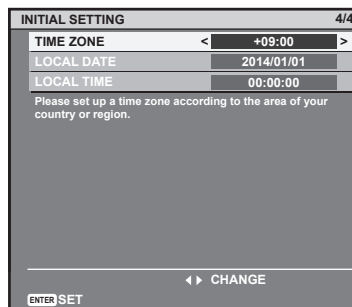

2) Press the <ENTER> button on the remote control.

- Confirm the setting value and complete the initial setting.

Note

- In the factory default setting, the time zone of the projector is set to +09:00 (Japan and Korean Standard Time). Change the time zone according to the region where you use the projector.

Making adjustments and selections

It is recommended to adjust the focus after 30 minutes have elapsed projecting.

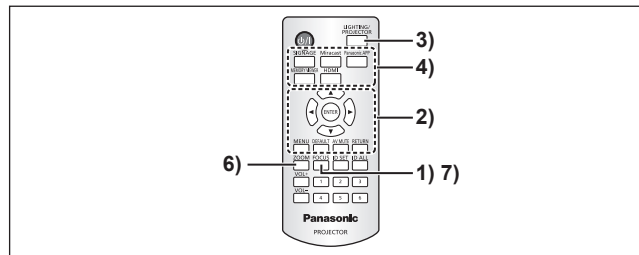

- 1) Press the <FOCUS> button on the remote control to roughly adjust the focus of the projection light. (➔ page 48)
- 2) Set the [SETUP] menu → [PROJECTION METHOD] (➔ page 68) and [VERTICAL FLIP] (➔ page 68) according to the installation condition.
 - Refer to “Navigating through the menu” (➔ page 55) for the operation of the menu screen.
- 3) Press the <LIGHTING/PROJECTOR> button on the remote control to switch the projection mode of the projector to lighting mode or projector mode. (➔ page 47)
- 4) When using the projector in the projector mode, press the <HDMI>, <MEMORY VIEWER>, <Miracast>, <Panasonic APP>, or <SIGNAGE> button on the remote control to select the input to project. (➔ page 47)
- 5) Adjust the orientation of the main unit to adjust the projection position. (➔ page 36)
- 6) Press the <ZOOM> button on the remote control to adjust the projection size. (➔ page 48)
- 7) Press the <FOCUS> button on the remote control again to adjust the focus.

Note

- The initial setting screen is displayed when the projector is turned on for the first time after purchase or when [ALL USER DATA] in the [SETUP] menu → [INITIALIZE] is executed. Refer to “When the initial setting screen is displayed” (➔ page 42).

Turning off the projector

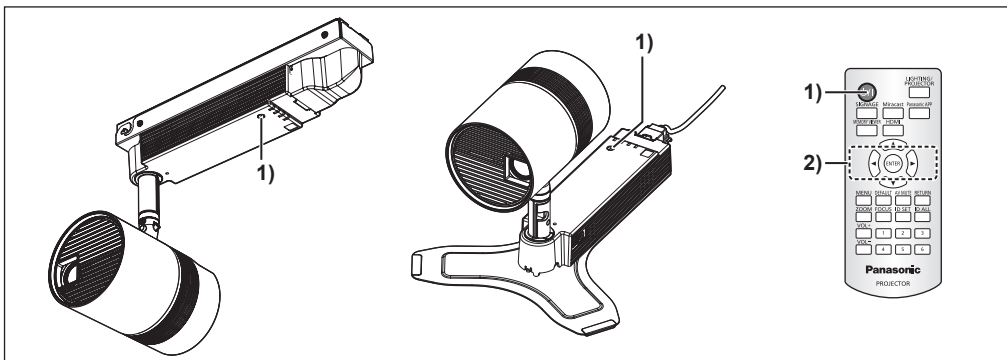

■ When using the optional Ceiling Kit

- 1) Press the power <⏻/|> button.
 - The [POWER OFF(STANDBY)] confirmation screen is displayed.
- 2) Press ◀▶ on the remote control to select [OK], and press the <ENTER> button. (Or press the power <⏻/|> button again.)
 - The projection is finished.
- 3) Wait for a few seconds until the power indicator <ON (G)/STANDBY (R)> lights in red.
- 4) Turn off the power supply of the interior wiring if necessary.

■ **When using the optional Floor Stand Kit**

- 1) **Press the power <⏻/|> button.**
 - The [POWER OFF(STANDBY)] confirmation screen is displayed.
- 2) **Press ◀▶ on the remote control to select [OK], and press the <ENTER> button.**
(Or press the power <⏻/|> button again.)
 - The projection is finished.
- 3) **Wait for a few seconds until the power indicator <ON (G)/STANDBY (R)> lights in red.**
- 4) **Disconnect the plug of the power cord from the outlet**

Note

- **The projector will continue to consume power when the power is supplied to the projector even if the power is turned off by pressing the power <⏻/|> button.**
The power consumption during standby can be conserved when the [SETUP] menu → [STANDBY MODE] is set to [ECO].
- The projector can be turned off by turning off the power supply of the interior wiring or disconnecting the plug of the power cord from the outlet during the projection, but the settings and adjustments performed right before turning off the power may not be reflected.
- Do not turn off the power supply of the interior wiring, disconnect the plug of the power cord from the outlet, or eject the SD card while the SD card indicator <SD> is blinking. The projector may not operate properly or the contents of the SD card may get damaged.
- When the [SETUP] menu → [ECO MANAGEMENT] → [STANDBY MODE] is set to [NORMAL], the internal cooling fan may operate even during standby.

Projecting

The projection will start after confirming the connection with the external device (➔ page 38) and turning on the power of the projector (➔ page 42). Select the projection mode and the input to project, and adjust the projection appearance of the projected image.

Selecting the projection mode

Switch the projection mode.

1) Press the <LIGHTING/PROJECTOR> button on the remote control.

- The lighting mode and the projector mode will switch back and forth each time the button is pressed.

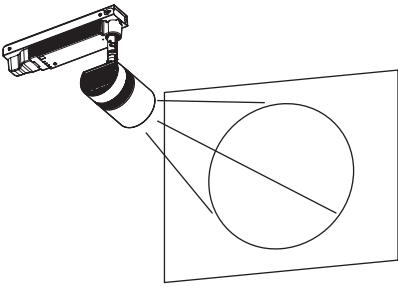
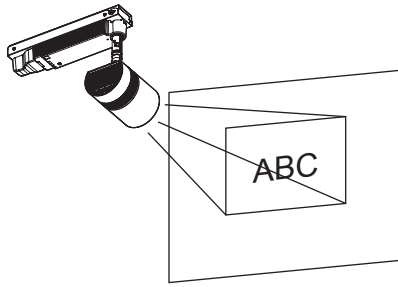
Lighting mode (example)	Projector mode (example)
	
It will irradiate like a spot light.	It will project an image as a projector.

Note

- An image cannot be projected in the lighting mode.
- It may take up to tens of seconds to complete the switching when the projection mode is switched. [Please wait...] is displayed on the projection screen when the switching takes time.

Selecting the input (for projector mode)

Switch the input to project.

1) Press the <HDMI>, <MEMORY VIEWER>, <Miracast>, <Panasonic APP>, or <SIGNAGE> button on the remote control to select the input.

- Image of the selected input is projected.

Remote control button	Input	Usage
<HDMI>	HDMI	Displays the image input to the <HDMI IN> terminal from the external device.
<MEMORY VIEWER>	Memory Viewer	Displays the still image or movie recorded in the SD card using the Memory Viewer function. (➔ page 93)
<Miracast>	Miracast	Displays the image transmitted wirelessly from the Miracast compatible terminal. (➔ page 126)
<Panasonic APP>	Panasonic APPLICATION	Displays the image transferred from the computer (including iPad, iPhone, iPod touch, or Android terminals) using the Panasonic image transfer application software.
<SIGNAGE>	Signage	Plays back and displays the contents such as still image or movie files in the SD card according to the schedule or slideshow setting registered with the Content Manager. (➔ page 127)

Note

- When an audio signal is included in each input, it is output from the <AUDIO OUT> terminal.
- To switch the input to anything other than the HDMI input, it may take tens of seconds to complete the switching. [Please wait...] is displayed on the projection screen when the switching takes time.
- The image transfer application software "Wireless Manager ME6.2" compatible with Windows computers or Mac is contained in the supplied CD-ROM. For the image transfer application software compatible with iPad/iPhone/iPod touch, and Android terminals, refer to the following URL.
<http://panasonic.net/avc/projector/>

Adjusting the projection

Adjust focus and zoom.

1) Press the <FOCUS> or <ZOOM> button on the remote control.

- <FOCUS> button: Adjusts focus.
- <ZOOM> button: Adjusts zoom.

2) Select each item and press ▲▼◀▶ to adjust it.

Note

- When a projection position is required to be adjusted, adjust according to the steps described in “Adjusting the projection position” (➔ page 36).
- The operation can be sped up by pressing ▲▼◀▶ for at least one second.
- It is recommended to adjust the focus after 30 minutes have elapsed projecting.
- Only [FOCUS] is shown in yellow so that the displayed menu item can be recognized by color, even when the projector is not focused and displayed characters are unreadable.

Using SD cards

The SD card slot of the projector supports the SD memory card and the SDHC memory card.

Notes on use

Observe following.

- Do not disassemble or modify.
- Do not apply strong shock, bend, drop, get wet, etc.
- Do not touch the metal contacts with your hands or metal.
- Do not peel off the affixed label or affix new label or seal.
- Do not leave in a place that will become hot (inside a car, under direct sunlight, etc.).
- Do not leave in a place with high humidity or dust.
- Do not leave in a place with extreme temperature difference. Condensation may occur.
- Do not leave in a place where static electricity or electromagnetic radiation is generated.
- Store SD card in an appropriate manner, and keep it away from small children.

Data protection

- To prevent losing important data, set the write protect switch on the SD card to “LOCK” position.
Turn off the write protect switch when saving or editing a file.



- Use a felt-tip pen (oil-based) when writing a character in the memo space of the label. Do not use pencil or ballpoint pen. The card may get damaged or the data may be destroyed.
- Manage the contents in the SD card under your responsibility. It is recommended to take a backup of important data on other disc, etc.
- Panasonic assumes no responsibility for loss of data recorded by yourself, or any other direct or indirect damage.
- It is recommended to physically destroy the card with a hammer, etc., when discarding.

Cards that can be used with the projector

SD memory card (2 GB)

(Including the miniSD memory card and the microSD memory card)

SDHC memory card (4 GB, 8 GB, 16 GB, 32 GB)

(Including the miniSDHC memory card and the microSDHC memory card)

Note

- Commercially available SD card is supported.
- Use the SD card with high data transfer speed. If the data transfer speed is slow, movie or music recorded in the SD card may not be played back properly or it may take time to display a still image. (Speed class: Class 10 recommended)
- Only the cards formatted in FAT16 or FAT32 can be used.

Inserting an SD card

- 1) Insert the card securely into the SD card slot with the front of the card facing upward, from the side with cut corner.

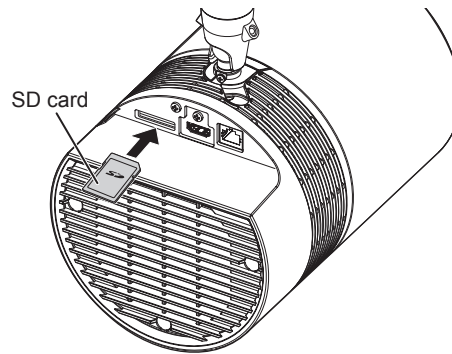

Attention

- When using the miniSD memory card or the microSD memory card, always use the dedicated miniSD memory card adapter or the microSD memory card adapter, and insert/eject together with the adapter.
- Take care not to leave the adapter in the SD card slot.
- Do not insert anything other than the SD card, such as metal or foreign object, into the SD card slot.
- Please refrain from frequent insertion and ejection of the SD card in short period of time. Wait for at least five seconds after inserting until ejecting the SD card, and wait for at least five seconds until inserting it again after ejecting. The projector requires approximately five seconds to recognize the insertion or ejection of the SD card.

Ejecting the SD card

- 1) Confirm that the SD card indicator <SD> is not blinking.
- 2) Lightly press center of the SD card.
- 3) Hold onto the slightly ejected SD card and pull it out.
 - Note that pulling out the card forcibly while it is inserted will cause a malfunction.

Attention

- Do not perform following when the projector is accessing the SD card (while the SD card indicator <SD> is blinking).
 - Ejecting the SD card
 - Turning off the power supply of the interior wiring
 - Disconnecting the plug of the power cord from the outlet
 - Applying vibration or shock
- Do not perform the insertion and ejection of the SD card in short period of time. Wait for at least five seconds after inserting until ejecting the SD card, and wait for at least five seconds until inserting it again after ejecting. The projector requires approximately five seconds to recognize the insertion and ejection of the SD card.

Operating with the remote control

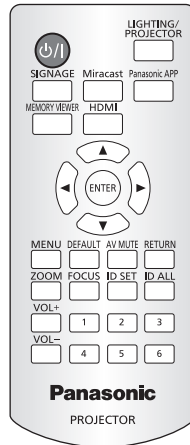

Switching the projection mode

Switch the projection mode.

LIGHTING/
PROJECTOR



1) Press the <LIGHTING/PROJECTOR> button.

- Switches to the lighting mode when pressed during the projector mode.
- Switches to the projector mode when pressed during the lighting mode.

Note

- An image cannot be projected in the lighting mode.
- The [MAIN MENU (PROJECTOR)] screen is displayed when the on-screen menu (menu screen) is displayed during the projector mode, and the [MAIN MENU (LIGHTING)] screen is displayed when the on-screen menu (menu screen) is displayed during the lighting mode.
- It may take up to tens of seconds to complete the switching when the projection mode is switched. [Please wait...] is displayed on the projection screen when the switching takes time.

Switching the input

The input for projection can be switched.

SIGNAGE Miracast Panasonic APP



MEMORY VIEWER HDMI



button

1) Press the <HDMI>, <MEMORY VIEWER>, <Miracast>, <Panasonic APP>, or <SIGNAGE> button.

<HDMI>	Switches the input to HDMI.
<MEMORY VIEWER>	Switches the input to Memory Viewer. (➡ page 66)
<Miracast>	Switches the input to Miracast. (➡ page 126)
<Panasonic APP>	Switches the input to Panasonic APPLICATION.
<SIGNAGE>	Switches the input to signage. (➡ page 127)

Note

- Pressing these buttons during the lighting mode will switch to projector mode, and image from each input is displayed.
- When the <HDMI>, <MEMORY VIEWER>, <Miracast>, <Panasonic APP>, or <LIGHTING/PROJECTOR> button is pressed during signage playback, the signage playback is stopped and switches to respective input or projection mode.
- Pressing the <SIGNAGE> button while the signage playback is stopped will switch the input to signage, and the signage playback will start or resume.
- Refer to “Content Manager” (➡ page 127) for the signage playback.

- To switch the input to anything other than the HDMI input, it may take tens of seconds to complete the switching. [Please wait...] is displayed on the projection screen when the switching takes time.

Adjusting the volume

The audio output volume can be adjusted.

VOL+



VOL-



button

- 1) Press the <VOL+> or <VOL-> button.

<VOL+>	Increases the volume.
<VOL->	Decreases the volume.

Using the AV mute function

The irradiation or the projection and the audio output can be paused temporarily when the projector is not used for specific time such as during break or preparation.

AV MUTE



button

- 1) Press the <AV MUTE> button.
 - The irradiation/projection and the audio are stopped.
- 2) Press the <AV MUTE> button again.
 - The irradiation/projection and the audio are resumed.

Note

- The power indicator <ON (G)/STANDBY (R)> blinks slowly when the projector is in AV mute mode.
- The projector has no built-in speakers. Audio is output from the external sound system connected to the <AUDIO OUT> terminal.

Setting the remote control ID numbers

When you use the system with multiple projectors, you can operate all the projectors simultaneously or each projector individually using single remote control, if a unique ID number is assigned to each projector. After setting the ID number of the projector, set same ID number on the remote control.

The factory default ID number of the projector is set to [ALL]. When using a single projector, press the <ID ALL> button on the remote control. Also, you can control a projector by pressing the <ID ALL> button on the remote control even if you do not know the projector ID.

ID SET ID ALL



button

- 1) Press the <ID SET> button on the remote control.
- 2) Within five seconds, press the number (<1> - <6>) buttons to set the one-digit ID number preset on the projector.
 - If you press the <ID ALL> button, you can control the projectors regardless of the ID number setting of the projector.

Attention

- Since the ID number of the remote control can be set without the projector, do not press the <ID SET> button on the remote control carelessly. If the <ID SET> button is pressed and no number (<1> - <6>) button is pressed within five seconds, the ID number returns to its original value before the <ID SET> button was pressed.
- The ID number set on the remote control will be stored unless it is set again. However, it will be erased if the remote control is left with dead batteries. Set the same ID number again when the batteries are replaced.

Note

- Set the ID number of the projector from the [SETUP] menu → [PROJECTOR ID].

Chapter 4 Settings

This chapter describes the settings and adjustments you can make using the on-screen menu.

Menu navigation

The on-screen menu (Menu) is used to perform various settings and adjustments of the projector.

Navigating through the menu

Operating procedure

When the projection mode is set to the projector mode, the [LIGHTING] menu is not displayed. Press the <LIGHTING/PROJECTOR> button on the remote control and switch to the lighting mode before starting operation. (➔ page 51)

MENU



button

1) Press the <MENU> button on the remote control.

- The [MAIN MENU] screen is displayed.

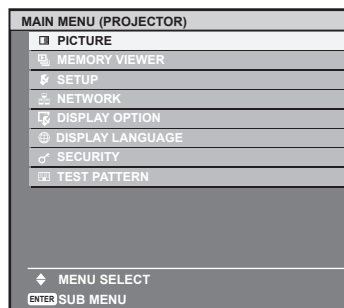

2) Press ▲▼ on the remote control to select a main menu item.

- The selected item is highlighted by yellow cursor.

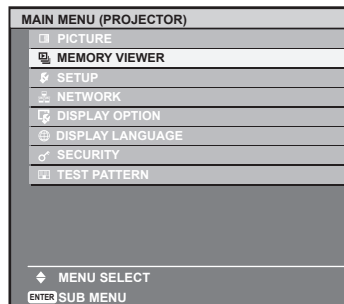

3) Press the <ENTER> button on the remote control.

- The sub-menu items of the selected main menu are displayed.

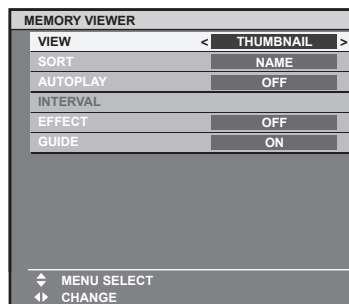

4) Press ▲▼ on the remote control to select a sub-menu item, and press ◀▶ or the <ENTER> button to change or adjust settings.

- Some items will switch in order as follows each time you press ◀▶.

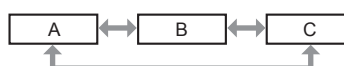

- For some items, press ◀▶ to display an individual adjustment screen with a bar scale as shown below.



Note

- Pressing the <RETURN> or <MENU> button on the remote control while the menu screen is displayed returns the screen to the upper hierarchical menu.
- In the projector mode, the [MAIN MENU (PROJECTOR)] screen is displayed as the menu screen. In the lighting mode, the [MAIN MENU (LIGHTING)] screen is displayed as the menu screen. The main menu items and sub-menu items displayed on the menu screen differ depending on the projection mode.
- Some items may not be allowed to adjust or use depending on the selected projection mode or signal input to the projector. The menu items that cannot be adjusted or used are shown in gray characters, and they cannot be selected.
- Some items can be adjusted even if signals are not input.
- Individual adjustment screen is cleared automatically if no operation is performed for approximately five seconds.
- For menu items, refer to “Main menu” (➔ page 56) and “Sub-menu” (➔ page 57).

Resetting the adjusted value to the factory default

If the <DEFAULT> button on the remote control is pressed, the values adjusted in the menu items are restored to the factory default settings.

DEFAULT



button

- 1) Press the <DEFAULT> button on the remote control.



Note

- You cannot reset all the settings to the factory default at a time.
- To reset all the adjusted sub-menu items to the factory defaults at a time, perform the [SETUP] menu → [INITIALIZE] (➔ page 76).
- Some items cannot be reset to the factory default settings even when the <DEFAULT> button on the remote control is pressed. Adjust those items individually.
- The square mark under the bar scale in the individual adjustment screen indicates the factory default value. The position of the square mark varies by the input signal.

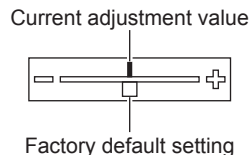

Setting the on-screen display to show/hide







If you hold down the <MENU> button on the remote control for at least three seconds, the on-screen setup screen appears and the on-screen display can be set to show/hide.

Main menu

The following nine items are included in the main menu. When a main menu item is selected, the screen changes to a sub-menu selection screen.

The main menu items displayed on the menu screen differ depending on the projection mode. When the projection mode is set to the projector mode, the [LIGHTING] menu is not displayed. Press the <LIGHTING/PROJECTOR> button on the remote control and switch to the lighting mode before starting operation. (➔ page 51)

Main menu item		Page
	[LIGHTING] ¹	60
	[PICTURE] ²	63
	[MEMORY VIEWER] ²	66

Main menu item		Page
	[SETUP]	68
	[NETWORK]	77
	[DISPLAY OPTION]	87
	[DISPLAY LANGUAGE]	89
	[SECURITY]	90
	[TEST PATTERN] ^{*2}	91

- *1 Only in the lighting mode
- *2 Only in the projector mode

Sub-menu

The sub-menu of the selected main menu item is displayed, and you can set and adjust items in the sub-menu. The menu items displayed differ depending on the projection mode.

[LIGHTING]

(Only in the lighting mode)

Sub-menu item	Factory default	Page
[PATTERN]	[CIRCULAR LIGHT1]	60
[COLOR SETTING]	[SUPER WHITE]	60
[DIMMER]	[+100]	62

[PICTURE]

(Only in the projector mode)

Sub-menu item	Factory default	Page
[PICTURE MODE]	[DYNAMIC]	63
[CONTRAST]	[0]	63
[BRIGHTNESS]	[0]	64
[COLOR]	[0]	64
[TINT]	[0]	64
[COLOR TEMPERATURE]	[MIDDLE]	64
[DIMMER]	[+100]	65

[MEMORY VIEWER]

(Only in the projector mode)

Sub-menu item	Factory default	Page
[VIEW]	[THUMBNAIL]	66
[SORT]	[NAME]	66
[AUTOPLAY]	[OFF]	66
[INTERVAL]	—	66
[EFFECT]	[OFF]	67
[GUIDE]	[ON]	67

[SETUP] 

Sub-menu item	Factory default	Page
[PROJECTOR ID]	[ALL]	68
[PROJECTION METHOD]*1	[FRONT]	68
[VERTICAL FLIP]*1	[OFF]	68
[ASPECT]*1	[NORMAL]	68
[KEYSTONE]	—	69
[SIGNAGE]	—	70
[HIGH ALTITUDE MODE]	[OFF]	71
[ECO MANAGEMENT]	—	71
[INITIAL STARTUP]*1	[LAST MEMORY]	72
[STARTUP INPUT SELECT]*1	[LAST USED]	73
[AUDIO SETTING]*1	—	73
[STATUS]	—	74
[DATE AND TIME]	—	74
[SAVE ALL USER DATA]	—	75
[LOAD ALL USER DATA]	—	75
[INITIALIZE]	—	76
[SERVICE PASSWORD]	—	76

*1 Only in the projector mode

[NETWORK] 

Sub-menu item	Factory default	Page
[PROJECTOR NAME]	[NAME1234]*1	77
[WIRED LAN]	—	77
[WIRELESS LAN]	[M-DIRECT]	78
[NETWORK CONTROL]	—	81
[Panasonic APPLICATION]*2	—	81
[NETWORK STATUS]	—	83
[Art-Net]	[OFF]	83

*1 Differs depending on the product.

*2 Only in the projector mode

[DISPLAY OPTION] 

(Only in the projector mode)

Sub-menu item	Factory default	Page
[HDMI IN]	—	87
[ON-SCREEN DISPLAY]	—	87
[AV MUTE]	—	88

[DISPLAY LANGUAGE] 

Details (➔ page 89)

[SECURITY] 

Sub-menu item	Factory default	Page
[SECURITY PASSWORD]	[OFF]	90
[SECURITY PASSWORD CHANGE]	—	90

[TEST PATTERN] 

(Only in the projector mode)

Details (➔ page 91)

[LIGHTING] menu

(Only in the lighting mode)

On the menu screen, select [LIGHTING] from the main menu, and select an item from the sub-menu.

Refer to “Navigating through the menu” (➔ page 55) for the operation of the menu screen.

- After selecting the item, press ▲▼◀▶ to set.

[PATTERN]

Select the lighting pattern.

- 1) Press ▲▼ to select [PATTERN].
- 2) Press ◀▶ or the <ENTER> button.
 - The [PATTERN] individual adjustment screen is displayed.
- 3) Press ◀▶ to switch the item.
 - The items will switch each time you press the button.

[CIRCULAR LIGHT1]	Sets the pattern to circular light.
[CIRCULAR LIGHT2]	Sets the pattern to circular light with shading on the edge.
[SD1] - [SD10]	Selects an item to use contents registered to an SD card.

Note

- For how to register the lighting pattern to an SD card, refer to “Registering a lighting pattern” (➔ page 193).
- Even when either of [SD1] to [SD10] is set as [PATTERN], the pattern will be the same as that for [CIRCULAR LIGHT1] if corresponding still image contents are not registered to the SD card or if an SD card is not inserted into the SD card slot.

[COLOR SETTING]

Set the color for lighting.

- 1) Press ▲▼ to select [COLOR SETTING].
- 2) Press ◀▶ or the <ENTER> button.
 - The [COLOR SETTING] individual adjustment screen is displayed.
- 3) Press ◀▶ to switch the item.
 - The items will switch each time you press the button.

[SUPER WHITE]	Sets the brightness to maximum.
[NEUTRAL]	Sets the color to neutral white.
[WHITE]	Sets the color to white.
[WARM WHITE]	Sets the color to warm white.
[LIGHT]	Sets the color to light bulb color.
[RED]	Sets the color to red.
[GREEN]	Sets the color to green.
[BLUE]	Sets the color to blue.
[YELLOW]	Sets the color to yellow.
[CYAN]	Sets the color to cyan.
[MAGENTA]	Sets the color to magenta.
[USER1] - [USER5]	Adjusts the color. Refer to “Setting a desired color” (➔ page 60) for details.

Note

- If [COLOR SETTING] is set to [NEUTRAL], [WHITE], [WARM WHITE], or [LIGHT], the color is also reflected in the menu screen.
- The [USER1] to [USER5] settings are shared with [User L1] to [User L5] in the Content Manager. Changes to the [USER1] to [USER5] settings are also reflected in [User L1] to [User L5] respectively. (“[Color]” (➔ page 198))

Setting a desired color

- 1) Press ▲▼ to select [COLOR SETTING].

- 2) Press ◀▶ or the <ENTER> button.
 - The [COLOR SETTING] individual adjustment screen is displayed.
- 3) Press ◀▶ to select [USER1] to [USER5].
- 4) Press the <ENTER> button.
 - The [COLOR SETTING] screen is displayed.
- 5) Press ▲▼ to select [BASE COLOR SETTING].
- 6) Press the <ENTER> button.
 - The [BASE COLOR SETTING] screen is displayed.
- 7) Press ▲▼ to select the base color, and press the <ENTER> button.

[SUPER WHITE]	Sets the base color to super white.
[NEUTRAL]	Sets the base color to neutral white.
[WHITE]	Sets the base color to white.
[WARM WHITE]	Sets the base color to warm white.
[LIGHT]	Sets the base color to light bulb color.
[RED]	Sets the base color to red.
[GREEN]	Sets the base color to green.
[BLUE]	Sets the base color to blue.
[YELLOW]	Sets the base color to yellow.
[CYAN]	Sets the base color to cyan.
[MAGENTA]	Sets the base color to magenta.

- 8) Press the <RETURN> or <MENU> button.
- 9) Press ▲▼ to select [RED], [GREEN], or [BLUE].
- 10) Press ◀▶ to adjust the level.

Item	Operation	Adjustment	Range of adjustment
[RED]	Press ▶.	Deepens red.	0 - +1024 (Factory default differs depending on the [BASE COLOR SETTING].)
	Press ◀.	Weakens red.	
[GREEN]	Press ▶.	Deepens green.	
	Press ◀.	Weakens green.	
[BLUE]	Press ▶.	Deepens blue.	
	Press ◀.	Weakens blue.	

Note

- If you set [BASE COLOR SETTING] to [NEUTRAL], [WHITE], [WARM WHITE], or [LIGHT], the setting is reflected in the menu screen, but the adjusted color setting is not reflected in the menu screen.
- Adjust [COLOR SETTING] correctly. All colors will not be displayed properly unless adequate adjustment is made. If the adjustment does not look suitable, you can press the <DEFAULT> button on the remote control to return the setting for only the selected item to the factory default value.

[DIMMER]

Adjust the brightness.

- 1) Press ▲▼ to select [DIMMER].
- 2) Press ◀▶ or the <ENTER> button.
 - The [DIMMER] individual adjustment screen is displayed.
- 3) Press ◀▶ to adjust the level.

Operation	Adjustment	Range of adjustment
Press ▶.	Makes brighter.	0 - +100 (Factory default is +100)
Press ◀.	Makes darker.	

Note

- Lighting color may appear reddish depending on the set value.
- The set value for [DIMMER] is also reflected in [DIMMER] (➔ page 65) in [PICTURE].

[PICTURE] menu

(Only in the projector mode)

On the menu screen, select [PICTURE] from the main menu, and select an item from the sub-menu.

Refer to “Navigating through the menu” (➔ page 55) for the operation of the menu screen.

- After selecting the item, press ▲▼◀▶ to adjust.

[PICTURE MODE]

You can switch to the desired picture mode suitable for the image source and the environment in which the projector is used.

- 1) Press ▲▼ to select [PICTURE MODE].
- 2) Press ◀▶ or the <ENTER> button.
 - The [PICTURE MODE] individual adjustment screen is displayed.
- 3) Press ◀▶ to switch the item.
 - The items will switch each time you press the button.

[DYNAMIC]	The light output is maximized for use in bright areas.
[NORMAL]	The image becomes suitable for movie-type video contents in general.

Note

- The [PICTURE MODE] setting is also reflected in the menu screen.

[CONTRAST]

Adjust the contrast of the colors.

- 1) Press ▲▼ to select [CONTRAST].
- 2) Press ◀▶ or the <ENTER> button.
 - The [CONTRAST] individual adjustment screen is displayed.
- 3) Press ◀▶ to adjust the level.

Operation	Adjustment	Range of adjustment
Press ▶.	Brightens the screen and makes the color deeper.	-31 - +31
Press ◀.	Darkens the screen and makes the color lighter.	

Attention

- Adjust [BRIGHTNESS] first when you need to adjust the black level.

[BRIGHTNESS]

Adjust the dark (black) part of the projected image.

- 1) Press ▲▼ to select [BRIGHTNESS].
- 2) Press ◀▶ or the <ENTER> button.
 - The [BRIGHTNESS] individual adjustment screen is displayed.
- 3) Press ◀▶ to adjust the level.

Operation	Adjustment	Range of adjustment
Press ▶.	Increases the brightness of the dark (black) parts of the screen.	-31 - +31
Press ◀.	Reduces the brightness of the dark (black) parts of the screen.	

[COLOR]

Adjust the color saturation of the projected image.

- 1) Press ▲▼ to select [COLOR].
- 2) Press ◀▶ or the <ENTER> button.
 - The [COLOR] individual adjustment screen is displayed.
- 3) Press ◀▶ to adjust the level.

Operation	Adjustment	Range of adjustment
Press ▶.	Deepens colors.	-31 - +31
Press ◀.	Weakens colors.	

[TINT]

Adjust the skin tone in the projected image.

- 1) Press ▲▼ to select [TINT].
- 2) Press ◀▶ or the <ENTER> button.
 - The [TINT] individual adjustment screen is displayed.
- 3) Press ◀▶ to adjust the level.

Operation	Adjustment	Range of adjustment
Press ▶.	Adjusts skin tone toward greenish color.	-31 - +31
Press ◀.	Adjusts skin tone toward reddish purple.	

[COLOR TEMPERATURE]

Switch the color temperature if the white areas of the projected image are bluish or reddish.

Adjusting with color temperature

- 1) Press ▲▼ to select [COLOR TEMPERATURE].
- 2) Press ◀▶ or the <ENTER> button.
 - The [COLOR TEMPERATURE] individual adjustment screen is displayed.
- 3) Press ◀▶ to switch the item.
 - The items will switch each time you press the button.

[LOW], [MIDDLE], [HIGH]	Select so that the desired color is obtained.
[USER]	Adjusts the white balance. Refer to "Adjusting desired white balance" (➔ page 65) for details.

Note

- The factory default setting for [COLOR TEMPERATURE] is [MIDDLE].

- The [USER] setting is shared with [User P] in the Content Manager. Changes to the [USER] setting are also reflected in [User P]. (“[Color]” (➔ page 198))

Adjusting desired white balance

- 1) Press ▲▼ to select [COLOR TEMPERATURE].
- 2) Press ◀▶ or the <ENTER> button.
 - The [COLOR TEMPERATURE] individual adjustment screen is displayed.
- 3) Press ◀▶ to select [USER].
- 4) Press the <ENTER> button.
 - The [COLOR TEMPERATURE] screen is displayed.
- 5) Press ▲▼ to select [RED], [GREEN], or [BLUE].
- 6) Press ◀▶ to adjust the level.

Item	Operation	Adjustment	Range of adjustment
[RED]	Press ▶.	Deepens red.	0 - +255 (Factory default is +255)
	Press ◀.	Weakens red.	
[GREEN]	Press ▶.	Deepens green.	
	Press ◀.	Weakens green.	
[BLUE]	Press ▶.	Deepens blue.	
	Press ◀.	Weakens blue.	

Note

- Adjust [COLOR TEMPERATURE] correctly. All colors will not be displayed properly unless adequate adjustment is made. If the adjustment does not look suitable, you can press the <DEFAULT> button on the remote control to return the setting for the selected item only to the factory default setting.
- The setting of [COLOR TEMPERATURE] is not reflected in internal test patterns (➔ page 91). Make sure to set [COLOR TEMPERATURE] while the input signal is projected.

[DIMMER]

Adjust the brightness.

- 1) Press ▲▼ to select [DIMMER].
- 2) Press ◀▶ or the <ENTER> button.
 - The [DIMMER] individual adjustment screen is displayed.
- 3) Press ◀▶ to adjust the level.

Operation	Adjustment	Range of adjustment
Press ▶.	Makes brighter.	0 - +100 (Factory default is +100)
Press ◀.	Makes darker.	

Note

- Video images may appear reddish depending on the set value.
- The set value for [DIMMER] is reflected in [DIMMER] (➔ page 62) in [LIGHTING].

[MEMORY VIEWER] menu

(Only in the projector mode)

On the menu screen, select [MEMORY VIEWER] from the main menu, and select an item from the sub-menu.

Refer to “Navigating through the menu” (➔ page 55) for the operation of the menu screen.

- After selecting the item, press ▲▼◀▶ to set.

Note

- Refer to “Memory Viewer function” (➔ page 93) for how to use the Memory Viewer function.

[VIEW]

Set the display view of the Memory Viewer screen.

- 1) Press ▲▼ to select [VIEW].
- 2) Press ◀▶ to switch the item.
 - The items will switch each time you press the button.

[THUMBNAIL]	Displays the files in thumbnail view.
[LIST]	Displays the files in list view.

[SORT]

Set the display order of files in the Memory Viewer screen.

- 1) Press ▲▼ to select [SORT].
- 2) Press ◀▶ to switch the item.
 - The items will switch each time you press the button.

[NAME]	Displays the files in the ascending order by the file name.
[TYPE]	Displays the files by the types of files.
[TIME]	Displays the files in order from the file whose update time is the oldest.

[AUTOPLAY]

Enable/disable automatic playback.

- 1) Press ▲▼ to select [AUTOPLAY].
- 2) Press ◀▶ to switch the item.
 - The items will switch each time you press the button.

[OFF]	Select this item to disable automatic playback.
[ON]	Select this item to enable automatic playback.

[INTERVAL]

Set display duration of the still image that is being automatically played back.

- 1) Press ▲▼ to select [INTERVAL].
- 2) Press ◀▶ to switch the item.

Item	Adjustment
[5S] - [120S]	Sets the display duration of still image. Select an item from [5S], [10S], [15S], [30S], [60S], and [120S].

Note

- When [AUTOPLAY] is set to [OFF], [INTERVAL] cannot be set.

- If you change the [INTERVAL] setting during playback on the Memory Viewer, the change will not be reflected on the projected image that is being played back. Return to the Memory Viewer screen in the thumbnail view or list view and restart playback. Refer to “Memory Viewer function” (➔ page 93) for how to use the Memory Viewer function.

[EFFECT]

Set special effects used when changing the playback screen of still image content.

- 1) Press ▲▼ to select [EFFECT].
- 2) Press ◀▶ to switch the item.
 - The items will switch each time you press the button.

[OFF]	Does not apply special effects.
[RANDOM]	Applies special effects randomly.
[WIPE LEFT]	Displays the image gradually from the left like wiping.
[WIPE RIGHT]	Displays the image gradually from the right like wiping.
[WIPE DOWN]	Displays the image gradually from the top like wiping.
[SPLIT]	Displays the image gradually from the center toward the left and right like wiping.
[ZOOM OUT]	Displays the image gradually from the center towards the entire image.
[FADE]	Displays the entire image gradually.
[BLIND]	Displays the image gradually like opening vertical blind.
[CHECKER WIPE]	Displays the image gradually from the left to right in checkerboard patterns.
[SLIDE IN]	Displays the next screen as if it slides in from the right to left.
[SLIDE OUT]	Displays the next screen by removing the current screen as if it slides out from the right to left.

Note

- If you change the [EFFECT] setting during playback on the Memory Viewer, the change will not be reflected on the projected image that is being played back. Return to the Memory Viewer screen in the thumbnail view or list view and restart playback. Refer to “Memory Viewer function” (➔ page 93) for how to use the Memory Viewer function.
- The item name and the description for [EFFECT] indicate the operation when [PROJECTION METHOD] and [VERTICAL FLIP] are set so that the character in the projection can correctly be read.

[GUIDE]

Set show/hide of the operation guide on the playback screen and the time bar that visually represents the playback progress of a movie.

- 1) Press ▲▼ to select [GUIDE].
- 2) Press ◀▶ to switch the item.
 - The items will switch each time you press the button.

[ON]	Select this item to show the operation guide and time bar (only for movie playback) while in full-screen playback.
[OFF]	Select this item to hide the operation guide and time bar.

Note

- When [ON] is set, the operation guide and time bar automatically disappears approximately three seconds after playback starts. Press ▲▼◀▶ or the <ENTER> button while in still image playback to display the operation guide. Press ▲◀▶ or the <ENTER> button while in movie playback to display the operation guide and time bar.

[SETUP] menu

On the menu screen, select [SETUP] from the main menu, and select an item from the sub-menu. Refer to “Navigating through the menu” (➔ page 55) for the operation of the menu screen.

- After selecting the item, press ▲▼◀▶ to set.

[PROJECTOR ID]

The projector has an ID number setting function that can be used when multiple projectors are used side by side to enable simultaneous control or individual control via a single remote control.

- 1) Press ▲▼ to select [PROJECTOR ID].
- 2) Press the <ENTER> button.
 - The [PROJECTOR ID] screen is displayed.
- 3) Press ▲▼ to select [PROJECTOR ID].

[ALL]	Set this item to control without specifying an ID number.
[1] - [6]	Set this item to specify an individual ID number to be controlled.

- 4) Press the <ENTER> button.

Note

- The ID number can be set to [ALL], or from [1] to [6].
- To specify an ID number for individual control, the ID number of a remote control must match the ID number of the projector.
- When the ID number is set to [ALL], the projector will operate regardless of the ID number specified during remote control or computer control.
 - If multiple projectors are set up side by side with IDs set to [ALL], they cannot be controlled separately from the projectors with other ID numbers.
- Refer to “Setting the remote control ID numbers” (➔ page 52) for how to set the ID number on the remote control.

[PROJECTION METHOD]

Set the projection method in accordance with the installation condition of the projector. Change the setting if the screen shows horizontally inverted image.

- 1) Press ▲▼ to select [PROJECTION METHOD].
- 2) Press ◀▶ to switch the item.
 - The items will switch each time you press the button.

[FRONT]	Select this item when projecting from the forward of the projection surface.
[REAR]	Select this item when projecting from the backward of the projection surface to forward (in such a way by using a translucent screen).

[VERTICAL FLIP]

Set the display method according to the conditions of use of the projector such as the installation condition and direction of projection.

Change the setting in such a case when the screen shows vertically flipped image.

- 1) Press ▲▼ to select [VERTICAL FLIP].
- 2) Press ◀▶ to select an item.
 - The items will switch each time you press the button.

[OFF]	The factory default setting.
[ON]	Select this item when the image is to be projected flipped vertically from the display status set to [OFF].

[ASPECT]

(Only in the projector mode)

You can switch the aspect ratio of the image.

- 1) Press ▲▼ to select [ASPECT].
- 2) Press ◀▶ or the <ENTER> button.
 - The [ASPECT] individual adjustment screen is displayed.
- 3) Press ◀▶ to switch the item.
 - The items will switch each time you press the button.

[NORMAL]	Displays images without changing the aspect ratio of the input signals.
[FULL]	Displays images in the entire screen range. When the aspect ratio of the input signal differs from that of the screen range, the images are displayed with the input signal converted to the aspect ratio of the screen.

Note

- If an aspect ratio which is different from the aspect ratio for the input signals is selected, the images will appear differently from the originals. Be careful of this when selecting the aspect ratio.
- If using the projector in places such as cafes or hotels to display programs for a commercial purpose or for public presentation, note that adjusting the aspect ratio or using the zoom function to change the screen images may be an infringement of the rights of the original copyright owner for that program under copyright protection laws. Be aware when you use the aspect ratio adjustment function of the projector.
- [FULL] may not be allowed to select for some signals.
- The setting of [ASPECT] is not reflected in internal test patterns (➔ page 91).

[KEYSTONE]

Correct keystone distortion that occurs when the projector main unit (projection lens surface) does not directly face the projection surface.

Setting [HV CORRECTION]

- 1) Press ▲▼ to select [KEYSTONE].
- 2) Press the <ENTER> button.
- 3) Press ▲▼ to select [HV CORRECTION].
- 4) Press the <ENTER> button.
 - The [HV CORRECTION] individual adjustment screen is displayed.
- 5) Press ▲▼◀▶ to adjust.

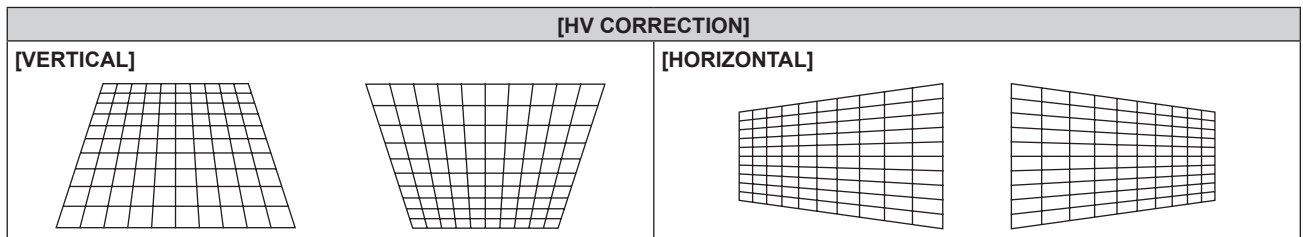

Setting [CORNER CORRECTION]

- 1) Press ▲▼ to select [KEYSTONE].
- 2) Press the <ENTER> button.
- 3) Press ▲▼ to select [CORNER CORRECTION].
- 4) Press the <ENTER> button.
 - The [CORNER CORRECTION] screen is displayed.
- 5) Press ▲▼ to select the item to adjust, and press the <ENTER> button.
 - The [CORNER CORRECTION] individual adjustment screen ([UPPER LEFT], [UPPER RIGHT], [LOWER LEFT], or [LOWER RIGHT]) is displayed.
- 6) Press ▲▼◀▶ to adjust.

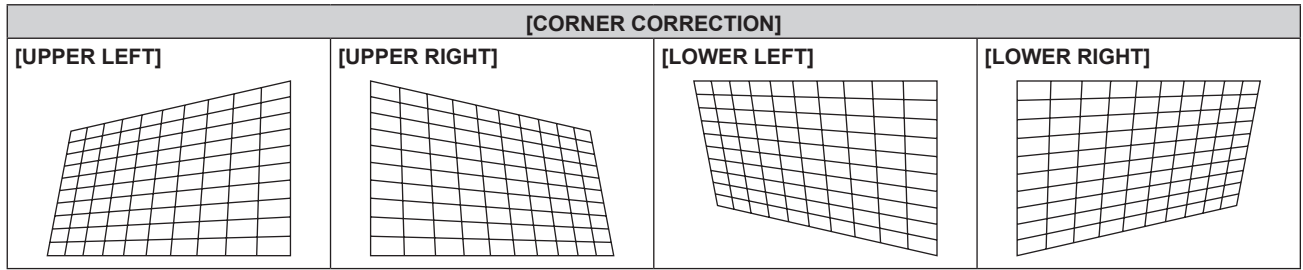

Note

- Either one of the setting [HV CORRECTION] or [CORNER CORRECTION] is enabled. If the other item is adjusted after [HV CORRECTION] or [CORNER CORRECTION] has been adjusted, the previous setting value will be reset.
- Pressing the <ENTER> button while the [CORNER CORRECTION] individual adjustment screen is displayed will display the individual adjustment screen for the next corner.
- Display position of the [CORNER CORRECTION] individual adjustment screen ([UPPER LEFT], [UPPER RIGHT], [LOWER LEFT], or [LOWER RIGHT]) is for when [PROJECTION METHOD] and [VERTICAL FLIP] are set so that the character in the projection can correctly be read.
- Correcting up to ±40° for the tilt in the vertical and horizontal directions (maximum value when adjusting only [VERTICAL] or [HORIZONTAL]) are available for [KEYSTONE] adjustment. However, the image quality will degrade and it will get harder to focus with more correction. Install the projector so that the correction will be as small as possible.
- Image size will also change when adjustments are performed with [KEYSTONE].
- The menu may run off the screen when adjustments are performed with [KEYSTONE].
- Aspect ratio of the image size may shift depending on the amount of correction or lens zoom value.
- The [KEYSTONE] setting is not reflected in internal test patterns (➔ page 91).

[SIGNAGE]

Set the playback method of contents using the signage playback function.

Setting [PLAY MODE]

Set the mode for signage playback.

- 1) Press ▲▼ to select [SIGNAGE].
- 2) Press the <ENTER> button.
 - The [SIGNAGE] screen is displayed.
- 3) Press ▲▼ to select [PLAY MODE].
- 4) Press ◀▶ to switch the item.
 - The items will switch each time you press the button.

[SCHEDULE]	Plays back contents (still image/movie/audio files in SD card, changing light source brightness, switching on/off operations) according to the registered schedule.
[SLIDESHOW]	Plays back contents (still image/movie files in SD card) according to the slideshow setting.

Note

- Perform schedule registration and slideshow setting with the Content Manager. Refer to “Content Manager” (➔ page 127) for details.
- Signage playback will not be performed if an SD card is not inserted, no schedule is registered in the SD card, or no slideshow setting exists.
- When operating the Content Manager to start playback of a schedule or slideshow, the [PLAY MODE] setting is automatically switched according to the playback mode.

Setting the restart option

Set the conditions for restarting signage playback (schedule) that has been stopped.

- 1) Press ▲▼ to select [SIGNAGE].
- 2) Press the <ENTER> button.
- 3) Press ▲▼ to select [POWER] or [IMAGE CONTENT].

[POWER]	The signage playback (schedule) restarts and the input switches to the signage when the power is turned off/on as registered in a schedule or the power is controlled with the power <⏻/⏻> button on the remote control or a command.
---------	---

[IMAGE CONTENT]	The signage playback (schedule) restarts and the input switches to the signage at the start time of a image content (still images/movies/external input contents/playlists in SD card) that is set as schedule.
-----------------	---

4) Press ◀▶ to select [DISABLE] or [ENABLE].

[DISABLE]	Disables the restart option.
[ENABLE]	Enables the restart option.

Note

- When [PLAY MODE] is set to [SLIDESHOW], [POWER] and [IMAGE CONTENT] in the restart option cannot be selected.
- Signage playback will not be restarted if an SD card is not inserted or no schedule is registered in the SD card.
- Signage playback can be restarted also by pressing the <SIGNAGE> button on the remote control. Pressing the <SIGNAGE> button while signage playback is stopped switches the input to signage and restarts or starts signage playback. In addition, pressing each of the <HDMI>, <MEMORY VIEWER>, <Miracast>, <Panasonic APP>, or <LIGHTING/PROJECTOR> button while in signage playback stops signage playback and switches the input or projection mode to a corresponding one.

[HIGH ALTITUDE MODE]

Set this item to other than [OFF] when using the projector at high altitudes between 1 000 m (3 281') and 2 700 m (8 858') above sea level.

- 1) Press ▲▼ to select [HIGH ALTITUDE MODE].
- 2) Press the <ENTER> button.
 - The [HIGH ALTITUDE MODE] screen is displayed.
- 3) Press ▲▼ to select an item, and press the <ENTER> button.

[OFF]	Select this item when using the projector at a location lower than 1 000 m (3 281') above sea level.
[HIGH1]	Select this item when using the projector at a location between 1 000 m (3 281') and 2 000 m (6 562') above sea level.
[HIGH2]	Select this item when using the projector at a location between 2 000 m (6 562') and 2 700 m (8 858') above sea level.

4) When the confirmation screen is displayed, press ◀▶ to select [OK], and press the <ENTER> button.

Note

- The speed of the internal cooling fan increases and the operation sound becomes louder when [HIGH1] or [HIGH2] is set.

[ECO MANAGEMENT]

This function optimizes power according to the operating status to reduce power consumption.

Setting [LIGHT POWER]

- 1) Press ▲▼ to select [ECO MANAGEMENT].
- 2) Press the <ENTER> button.
 - The [ECO MANAGEMENT] screen is displayed.
- 3) Press ▲▼ to select [LIGHT POWER].
- 4) Press ◀▶ to switch the item.
 - The items will switch each time you press the button.

[NORMAL]	Select this item when high luminance is required.
[ECO]	Select this item when high luminance is not required.

Note

- When [ECO] is set, the power consumption can be saved and operation sound can be reduced compared to when [NORMAL] is set.
- When [ECO] is set, the images may appear different from that when [NORMAL] is set.

Setting [NO SIGNAL SHUT-OFF]

(Only in the projector mode)

This function automatically switches the power of the projector to standby if the input is HDMI and there is no input signal for a certain period of time. The time before switching to standby can be set.

- 1) Press ▲▼ to select [ECO MANAGEMENT].
- 2) Press the <ENTER> button.
 - The [ECO MANAGEMENT] screen is displayed.
- 3) Press ▲▼ to select [NO SIGNAL SHUT-OFF].
- 4) Press ◀▶ to switch the item.
 - The items will switch each time you press the button.

[10MIN.] - [90MIN.]	Sets the time in 10-minute intervals.
[DISABLE]	Disables [NO SIGNAL SHUT-OFF].

Note

- If the input is set to other than HDMI, [NO SIGNAL SHUT-OFF] is disabled.
- The factory default setting for [NO SIGNAL SHUT-OFF] is [10MIN.].

Setting [STANDBY MODE]

Set the power consumption during standby.

- 1) Press ▲▼ to select [ECO MANAGEMENT].
- 2) Press the <ENTER> button.
 - The [ECO MANAGEMENT] screen is displayed.
- 3) Press ▲▼ to select [STANDBY MODE].
- 4) Press ◀▶ to switch the item.
 - The items will switch each time you press the button.

[ECO]	Select this item to reduce power consumption during standby.
[NETWORK]	Select this item to reduce power consumption during standby, and to operate the projector via wired LAN using the Wake on LAN function.
[NORMAL]	Select this item to use the network function during standby. Or, select this item to synchronize with the NTP server and adjust the date and time of the projector automatically.

Note

- When [ECO] is set, network functions are not available during standby.
- When [ECO] is set, there may be a delay in displaying when the power is turned on, compared to when [NORMAL] is set.
- When [NETWORK] is set, the Wake on LAN function enables the network function available for 60 seconds even during standby.
- When [NORMAL] is set, the internal cooling fan may run during standby.
- The [STANDBY MODE] setting is not reset to the factory default even when [ALL USER DATA] is executed from the [SETUP] menu → [INITIALIZE] (➡ page 76).
- If the following three settings are made, the image will disappear temporarily when synchronizing with the NTP server once after you have turned on the power or the power has been turned on.
 - Setting [STANDBY MODE] to [ECO] or [NETWORK]
 - Setting the [SETUP] menu → [DATE AND TIME] → [ADJUST CLOCK] → [NTP SYNCHRONIZATION] to [ON]
 - Refer to “Setting the date and time automatically” (➡ page 75) for details.
 - Setting the input to signage

[INITIAL STARTUP]

Set the startup method when the power supply of the interior wiring is turned on or when the plug of the power cord is connected to an outlet.

- 1) Press ▲▼ to select [INITIAL STARTUP].
- 2) Press ◀▶ to switch the item.
 - The items will switch each time you press the button.

[LAST MEMORY]	Starts up the projector in a status before turning off the power supply of the interior wiring or disconnecting the plug of the power cord from the outlet.
[STANDBY]	Starts up the projector in standby.
[ON]	Starts projecting immediately.

[STARTUP INPUT SELECT]

Set the projection mode and input when the projector is turned on to start projection.

- 1) Press ▲▼ to select [STARTUP INPUT SELECT].
- 2) Press ◀▶ to switch the item.
 - The items will switch each time you press the button.

[LAST USED]	Keeps the projection mode and input that has been selected the last time.
[HDMI]	Sets the input to HDMI.
[Miracast]	Sets the input to Miracast.
[Panasonic APPLICATION]	Sets the input to Panasonic APPLICATION.
[MEMORY VIEWER]	Sets the input to Memory Viewer.
[SIGNAGE]	Sets the input to signage.
[LIGHTING]	Starts projecting in the lighting mode.

Note

- If [POWER] of the restart option is enabled in “Setting the restart option” (➔ page 70) which explains the [SETUP] menu → [SIGNAGE], the input switches to signage regardless of the [STARTUP INPUT SELECT] setting, as the signage playback (schedule) restarts at the same time when the power is turned on.

[AUDIO SETTING]

Set detailed audio functions.

Adjusting the volume

- 1) Press ▲▼ to select [AUDIO SETTING].
- 2) Press the <ENTER> button.
 - The [AUDIO SETTING] screen is displayed.
- 3) Press ▲▼ to select [VOLUME].
- 4) Press ◀▶ to adjust the level.

Operation	Adjustment	Range of adjustment
Press ▶.	Increases the volume.	0 - 63
Press ◀.	Decreases the volume.	

Adjusting the right/left audio balance

- 1) Press ▲▼ to select [AUDIO SETTING].
- 2) Press the <ENTER> button.
 - The [AUDIO SETTING] screen is displayed.
- 3) Press ▲▼ to select [BALANCE].
- 4) Press ◀▶ to adjust the level.

Operation	Adjustment	Range of adjustment
Press ▶.	Increases the volume on the right.	L16 - R16
Press ◀.	Increases the volume on the left.	

Note

- The projector has no built-in speakers. Audio is output from the external audio system connected to the <AUDIO OUT> terminal.

[STATUS]

Display the status of the projector.

- 1) Press ▲▼ to select [STATUS].
- 2) Press the <ENTER> button.
 - The [STATUS] screen is displayed.
- 3) Press ◀▶ to switch the pages.
 - The page will change each time you press the button.

[INPUT]	Displays the currently selected input.
[SIGNAGE]	Displays the status of signage playback.
[SIGNAL NAME]	Displays the input signal name.
[SIGNAL FREQUENCY]	Displays the frequency of the input signal.
[PROJECTOR RUNTIME]	Displays the runtime of the projector.
[INTAKE AIR TEMP.]	Displays the status of the air intake temperature of the projector.
[OPTICS MODULE TEMP.]	Displays the status of the internal temperature of the projector.
[PROJECTOR TYPE]	Displays the type of the projector.
[SERIAL NUMBER]	Displays the serial number of the projector.
[MAIN VERSION]	Displays the main version of the firmware of the projector.
[SUB VERSION]	Displays the sub version of the firmware of the projector.
[NETWORK VERSION]	Displays the network version of the projector.

Note

- The content of status can be sent via E-mail to E-mail addresses (up to two) set in “[E-mail set up] page” (➔ page 116) by pressing the <ENTER> button while the [STATUS] screen is displayed.

[DATE AND TIME]

Set the time zone, date, and time of the built-in clock of the projector.

Setting the time zone

- 1) Press ▲▼ to select [DATE AND TIME].
- 2) Press the <ENTER> button.
 - The [DATE AND TIME] screen is displayed.
- 3) Press ▲▼ to select [TIME ZONE].
- 4) Press ◀▶ to switch [TIME ZONE].

Setting the date and time manually

- 1) Press ▲▼ to select [DATE AND TIME].
- 2) Press the <ENTER> button.
 - The [DATE AND TIME] screen is displayed.
- 3) Press ▲▼ to select [ADJUST CLOCK].
- 4) Press the <ENTER> button.
 - The [ADJUST CLOCK] screen is displayed.
- 5) Press ▲▼ to select an item, and press ◀▶ to set the local date and time.
- 6) Press ▲▼ to select [APPLY], and press the <ENTER> button.
 - The setting of the date and time will be completed.

Setting the date and time automatically

To synchronize with the NTP server and adjust the date and time of the projector automatically, set [NTP SYNCHRONIZATION] to [ON].

NTP server is a device such as a computer which delivers the date and time data by NTP (Network Time Protocol).

- 1) Press ▲▼ to select [DATE AND TIME].
- 2) Press the <ENTER> button.
 - The [DATE AND TIME] screen is displayed.
- 3) Press ▲▼ to select [ADJUST CLOCK].
- 4) Press the <ENTER> button.
 - The [ADJUST CLOCK] screen is displayed.
- 5) Press ▲▼ to select [NTP SYNCHRONIZATION], and press ◀▶ to change the setting to [ON].
- 6) Press ▲▼ to select [APPLY], and press the <ENTER> button.
 - The setting of the date and time will be completed.

Note

- To set the date and time automatically, the projector must be connected to the network.
- If you set the date and time automatically, set the [SETUP] menu → [ECO MANAGEMENT] → [STANDBY MODE] (▶ page 72) to [NORMAL]. If an item other than [NORMAL] has been set and the input has been set to signage, the image will disappear temporarily when synchronizing with the NTP server once after you have turned on the power or the power has been turned on.
- If synchronization with the NTP server fails just after [NTP SYNCHRONIZATION] is turned [ON], or if [NTP SYNCHRONIZATION] is turned [ON] while the NTP server is not set, [NTP SYNCHRONIZATION] will return to [OFF].
- Access the projector via a web browser to set the NTP server. Refer to “[Adjust clock] page” (▶ page 114) for details.
- The projector is equipped with the NTP server function. By using this projector as an NTP server, you can synchronize the time of other projectors in the same network. For example, it is effective when you use multiple projectors of this model and play back the schedule of the Content Manager simultaneously, under the environment where access to an external NTP server is not possible. For the steps to play back a schedule simultaneously, refer to “Playing back the schedule simultaneously in multiple projectors” (▶ page 182).

[SAVE ALL USER DATA]

Save the various setting values as backup to the built-in memory of the projector.

- 1) Press ▲▼ to select [SAVE ALL USER DATA].
- 2) Press the <ENTER> button.
 - The [SECURITY PASSWORD] screen is displayed.
- 3) Enter a security password and press the <ENTER> button.
- 4) When the confirmation screen is displayed, press ◀▶ to select [OK], and press the <ENTER> button.

Attention

- Do not turn off the power supply of the interior wiring or disconnect the plug of the power cord from the outlet while data is being saved.

Note

- When [SAVE ALL USER DATA] is executed, it may take approximately 30 seconds to complete saving data. Note that while data is being saved, lighting and projection disappears, and operations of all buttons on the remote control and the power <⏻/▶> button on the power supply unit are disabled.

[LOAD ALL USER DATA]

Load the various setting values saved as backup in the built-in memory of the projector.

- 1) Press ▲▼ to select [LOAD ALL USER DATA].
- 2) Press the <ENTER> button.
 - The [SECURITY PASSWORD] screen is displayed.
- 3) Enter a security password and press the <ENTER> button.
- 4) When the confirmation screen is displayed, press ◀▶ to select [OK], and press the <ENTER> button.

Note

- The projector will go into the standby mode to reflect the setting values when [LOAD ALL USER DATA] is executed.

[INITIALIZE]

Return various setting values to their factory default settings.

- 1) Press ▲▼ to select [INITIALIZE].
- 2) Press the <ENTER> button.
 - The [SECURITY PASSWORD] screen is displayed.
- 3) Enter a security password and press the <ENTER> button.
 - The [INITIALIZE] screen is displayed.
- 4) Press ▲▼ to select an item to initialize.

[ALL USER DATA]	Returns all setting items including [SIGNAGE], [NETWORK], and [E-mail set up] to the factory default settings. The projector enters the standby mode to reflect the setting values.
[NETWORK/E-MAIL]	Returns [SIGNAGE], [NETWORK], and [E-mail set up] to the factory default settings.

- 5) Press the <ENTER> button.
- 6) When the confirmation screen is displayed, press ◀▶ to select [OK], and press the <ENTER> button.
 - [PROGRESS] is displayed while initialization is being performed.

Note

- When [ALL USER DATA] of [INITIALIZE] is executed, turn the power supply of the interior wiring off and on, or disconnect and connect the plug of the power cord to the outlet, and then turn on the projector.

[SERVICE PASSWORD]

This function is used by a service person.

[NETWORK] menu

On the menu screen, select [NETWORK] from the main menu, and select an item from the sub-menu. Refer to “Navigating through the menu” (➔ page 55) for the operation of the menu screen.

- After selecting the item, press ▲▼◀▶ to set.

[PROJECTOR NAME]

Change the name as desired in such a case as the projector needs to be identified on application software.

- 1) Press ▲▼ to select [PROJECTOR NAME].
- 2) Press the <ENTER> button.
 - The [PROJECTOR NAME] screen is displayed.
- 3) Press ▲▼◀▶ to select a character, and press the <ENTER> button to enter.
 - Up to eight characters can be entered.
- 4) After the projector name has been entered, press ▲▼◀▶ to select [OK], and press the <ENTER> button.
 - If you press ▲▼◀▶ to select [CANCEL] and then press the <ENTER> button, the changed projector name will not be registered and the factory default projector name will remain.

Note

- The factory default projector name is “NAMExxxx” (xxxx stands for a four-digit number and varies by each product).

[WIRED LAN]

Configure the settings as necessary before using the wired LAN function.

- 1) Press ▲▼ to select [WIRED LAN].
- 2) Press the <ENTER> button.
 - The [WIRED LAN] screen is displayed.
- 3) Press ▲▼ to select an item, and change the settings according to the operation instructions of the menu.

[DHCP]	Set to [ON] when obtaining an IP address automatically using a DHCP server. Set to [OFF] when not using a DHCP server.
[IP ADDRESS]	Enter the IP address when not using a DHCP server.
[SUBNET MASK]	Enter the subnet mask when not using a DHCP server.
[DEFAULT GATEWAY]	Enter the default gateway address when not using a DHCP server.
[DNS1]	Enter the primary DNS server address when not using a DHCP server.
[DNS2]	Enter the secondary DNS server address when not using a DHCP server.

- 4) Press ▲▼ to select [STORE], and press the <ENTER> button.
- 5) When the confirmation screen is displayed, press ◀▶ to select [OK], and press the <ENTER> button.

Note

- When using a DHCP server, confirm that the DHCP server is running.
- Consult your network administrator regarding the IP address, subnet mask, and default gateway.
- When [WIRED LAN] is selected in the [NETWORK] menu → [Art-Net] (➔ page 83), this [WIRED LAN] setting is disabled.
- When [WIRED LAN] is selected and the network address is changed in the [NETWORK] menu → [Art-Net] (➔ page 83), the address is reflected in the address for this [WIRED LAN] setting.
- The following settings are configured as the factory default.

[DHCP]	OFF
[IP ADDRESS]	192.168.10.100
[SUBNET MASK]	255.255.255.0
[DEFAULT GATEWAY]	192.168.10.1
[DNS1]/[DNS2]	None

[WIRELESS LAN]

Set the connection method of wireless LAN.

- 1) Press ▲▼ to select [WIRELESS LAN].
- 2) Press ◀▶ to select the connection method.

[M-DIRECT]	Select this item to use as a simple access point. The projector and a device such as a computer can be connected in the infrastructure mode without an access point. Wireless LAN connection can be established using “Wireless Manager ME6.2” or Panasonic’s image transfer application software that supports iPad/iPhone/iPod touch, and Android terminals. Connection with iPad/iPhone/iPod touch, and Android terminals will be easier. Detailed network settings can also be configured according to the network environment in use. Refer to “Setting [M-DIRECT]” (➔ page 78) for details.
[USER1]/[USER2]/[USER3]	Detailed network settings can be configured according to the network environment in use. Refer to “Setting [USER1]/[USER2]/[USER3]” (➔ page 79) for details.
[DISABLE]	Select this item when you do not use wireless LAN.
[S-DIRECT]	Select this item to connect the projector via wireless LAN using the image transfer application software “Wireless Manager ME6.2” included in the supplied CD-ROM that supports Windows computers and Mac. Refer to the Operating Instructions of “Wireless Manager ME6.2” for how to use the software.

Attention

- This device is restricted to indoor use when operated in the 5.15 to 5.35 GHz frequency range (Channels 36 to 64).

Note

- If [S-DIRECT] or [M-DIRECT] is set, up to 10 devices can be connected to the projector via wireless LAN.
- Even when [S-DIRECT] or [M-DIRECT] is selected in [WIRELESS LAN], the setting will be disabled if the input is Miracast.
- When [WIRELESS LAN] is selected in the [NETWORK] menu → [Art-Net] (➔ page 83), this [WIRELESS LAN] setting is disabled.
- When [WIRELESS LAN] is selected and the network setting is changed in the [NETWORK] menu → [Art-Net] (➔ page 83), the setting is reflected in the network setting for [USER3] of this [WIRELESS LAN] setting.
- If the string of SSID exceeds 16 characters, the SSID is displayed in two lines.
- Refer to the following URL for the image transfer application software that wirelessly transfers images etc. saved in iPad/iPhone/iPod touch, and Android terminals to the projector.
<http://panasonic.net/avc/projector/>

Setting [M-DIRECT]

- 1) Press ▲▼ to select [WIRELESS LAN].
- 2) Press ◀▶ to select [M-DIRECT].
- 3) Press the <ENTER> button.
 - The [WIRELESS LAN] ([M-DIRECT]) screen is displayed.
- 4) Press ▲▼ to select each item, and change the settings according to the operation instructions of the menu.

[IP ADDRESS]	Enter the IP address.
[SUBNET MASK]	Enter the subnet mask.
[SSID]	Set SSID to use.
[CHANNEL]	Select the channel to use from 1 to 13, 36, 40, 44, and 48.
[KEY]	Set the key to use. Enter 8 to 63 alphanumeric characters or 64-digit hexadecimal.

- 5) Press ▲▼ to select [STORE], and press the <ENTER> button.
- 6) When the confirmation screen is displayed, press ◀▶ to select [OK], and press the <ENTER> button.

Note

- The following settings are configured as the factory default.

[IP ADDRESS]	192.168.12.100
[SUBNET MASK]	255.255.255.0
[SSID]	M-DIRECTxxxx (xxxx stands for the last four-digit number of the network ID.)

[CHANNEL]	1
[KEY]	The same character string as SSID

- The authentication method is fixed to WPA2-PSK and the encryption method is fixed to AES, and they cannot be changed.
- Consult your network administrator before you change the values from the factory default.
- If [KEY] is kept as the factory default value, information leak by a third party may occur. Be sure to change it from the factory default value.
- Since the DHCP server automatically starts up, set the DHCP setting of devices to be wirelessly connected to the projector to on and connect them.

Setting [USER1]/[USER2]/[USER3]

- 1) Press ▲▼ to select [WIRELESS LAN].
- 2) Press ◀▶ to select [USER1], [USER2], or [USER3].
- 3) Press the <ENTER> button.
 - The [WIRELESS LAN] ([USER1], [USER2], or [USER3]) screen (1/2) is displayed.
- 4) Press ▲▼ to select each item, and change the settings according to the operation instructions of the menu.

[DHCP]	Set to [ON] when obtaining an IP address automatically using a DHCP server. Set to [OFF] when not using a DHCP server.
[IP ADDRESS]	Enter the IP address when not using a DHCP server.
[SUBNET MASK]	Enter the subnet mask when not using a DHCP server.
[DEFAULT GATEWAY]	Enter the default gateway address when not using a DHCP server.
[DNS1]	Enter the primary DNS server address when not using a DHCP server.
[DNS2]	Enter the secondary DNS server address when not using a DHCP server.

Note

- When you use a DHCP server, confirm that the DHCP server is running.
- Consult your network administrator regarding the IP address, subnet mask, default gateway, and DNS server address.
- Wired LAN and wireless LAN cannot be used in the same segment.

- 5) Press ▲▼ to select [NEXT], and press the <ENTER> button.
 - The [WIRELESS LAN] ([USER1], [USER2], or [USER3]) screen (2/2) is displayed.
- 6) Press ▲▼ to select each item, and change the settings according to the operation instructions of the menu.

[SSID]	Enter the same string as the SSID registered to the access point.	
[AUTHENTICATION]	Select the user authentication method used in the network to which the projector is connected.	
	[OPEN]	Select this item when the authentication method of the access point is Open System.
	[SHARED]	Select this item when the authentication method of the access point is Shared Key.
	[WPA-PSK]	Select this item when the authentication method of the access point is WPA-PSK.
	[WPA2-PSK]	Select this item when the authentication method of the access point is WPA2-PSK.
	[WPA-EAP/WPA2-EAP]	Select this item when the authentication method of the access point is WPA-EAP/WPA2-EAP.
	[WPA-EAP]	Select this item when the authentication method of the access point is WPA-EAP.
[WPA2-EAP]	Select this item when the authentication method of the access point is WPA2-EAP.	

[ENCRYPTION]		Select the encryption method used for the communication between the projector and the network.
	[NONE]	Select this item not to use encryption. It can be selected only when [AUTHENTICATION] is set to [OPEN] or [SHARED].
	[WEP]	Select this item when the encryption method is WEP.
	[TKIP]	Select this item when the encryption method is TKIP. It can be selected only when [AUTHENTICATION] is set to [WPA-PSK], [WPA2-PSK], [WPA-EAP], or [WPA2-EAP].
	[AES]	Select this item when you use AES for the encryption method. It can be selected only when [AUTHENTICATION] is set to [WPA-PSK], [WPA2-PSK], [WPA-EAP], or [WPA2-EAP].
[DEFAULT KEY]		Set a number from 1 to 4 for the default key. It can be selected only when [AUTHENTICATION] is set to [OPEN] or [SHARED], and the encryption method is [WEP].
[KEY1] - [KEY4]		Set WEP key to the key number selected in [DEFAULT KEY]. It can be selected only when [AUTHENTICATION] is set to [OPEN] or [SHARED], and the encryption method is [WEP]. You can set a 64-bit or 128-bit WEP key. Enter five single-byte alphanumeric characters (10 digits for hexadecimal) for 64-bit, or enter 13 single-byte alphanumeric characters (26 digits for hexadecimal) for 128-bit.
[KEY]		Set the key. It can be selected when [AUTHENTICATION] is set to [WPA-PSK] or [WPA2-PSK]. Enter 8 to 63 alphanumeric characters or 64-digit hexadecimal.
[EAP]		Select the EAP set for RADIUS server. It can be selected when [AUTHENTICATION] is set to [WPA-EAP/WPA2-EAP], [WPA-EAP], or [WPA2-EAP]. The types of EAP that can be selected are as follows. [PEAP(MS-CHAPv2)], [PEAP(GTC)], [EAP-TTLS(MD5)], [EAP-TTLS(MS-CHAPv2)], [EAP-FAST(MS-CHAPv2)], [EAP-FAST(GTC)]
[USER NAME]		Enter the user name to be used for authentication in single-byte alphanumeric characters (space not included, 64 characters at the maximum). It can be selected when [AUTHENTICATION] is set to [WPA-EAP/WPA2-EAP], [WPA-EAP], or [WPA2-EAP].
[PASSWORD]		Enter the password to be used for authentication in single-byte alphanumeric characters (64 characters at the maximum). It can be selected when [AUTHENTICATION] is set to [WPA-EAP/WPA2-EAP], [WPA-EAP], or [WPA2-EAP].

Note

- Contact the manufacturer of the access point (radio repeating device) in use if wireless LAN connection cannot be established via the access point even after “Setting for projector” (➔ page 102) is executed.
- If you use EAP, settings of the projector need to be configured according to the RADIUS server settings. Consult your network administrator for the RADIUS server settings.
- If you use EAP in combination with an access point where SSID broadcast is disabled, select [WPA-EAP] or [WPA2-EAP] for authentication method even when the authentication of the access point is WPA-EAP/WPA2-EAP.

7) Press ▲▼ to select [STORE], and press the <ENTER> button.

- Press ▲▼ to select [RETURN] and then press the <ENTER> button to return to the [WIRELESS LAN] ([USER1], [USER2], or [USER3]) screen (1/2).

8) When the confirmation screen is displayed, press ◀▶ to select [OK], and press the <ENTER> button.

Note

- The following settings are configured for [USER1], [USER2], and [USER3] as the factory default.

[DHCP]	OFF
[IP ADDRESS]	192.168.11.100
[SUBNET MASK]	255.255.255.0
[DEFAULT GATEWAY]	192.168.11.1
[DNS1]/[DNS2]	(Blank)
[SSID]	Panasonic Projector
[AUTHENTICATION]	Open
[ENCRYPTION]	None

Changing the [USER1]/[USER2]/[USER3] name

1) Press ▲▼ to select [WIRELESS LAN].

- 2) Press ◀▶ to select [USER1], [USER2], or [USER3].
- 3) Press the <ENTER> button.
 - The [WIRELESS LAN] ([USER1], [USER2], or [USER3]) screen (1/2) is displayed.
- 4) Press ▲▼ to select [NAME CHANGE].
- 5) Press the <ENTER> button.
 - The [NAME CHANGE] screen is displayed.
- 6) Press ▲▼◀▶ to select a character, and press the <ENTER> button to enter.
 - Up to eight characters can be entered.
- 7) After the name has been entered, press ▲▼◀▶ to select [OK], and press the <ENTER> button.
 - When you press ▲▼◀▶ to select [CANCEL] and then press the <ENTER> button, the changed name will not be registered and the factory default name will remain.
- 8) Press ▲▼ to select [NEXT], and press the <ENTER> button.
 - The [WIRELESS LAN] ([USER1], [USER2], or [USER3]) screen (2/2) is displayed.
- 9) Press ▲▼ to select [STORE], and press the <ENTER> button.
 - Press ▲▼ to select [RETURN] and then press the <ENTER> button to return to the [WIRELESS LAN] ([USER1], [USER2], or [USER3]) screen (1/2).
- 10) When the confirmation screen is displayed, press ◀▶ to select [OK], and press the <ENTER> button.

[NETWORK CONTROL]

Set up the control method of the network.

- 1) Press ▲▼ to select [NETWORK CONTROL].
- 2) Press the <ENTER> button.
 - The [NETWORK CONTROL] screen is displayed.
- 3) Press ▲▼ to select an item, and press ◀▶ to change the setting.

[WEB CONTROL]	Set to [ON] to control with the web browser.
[PJLink CONTROL]	Set to [ON] to control with the PJLink protocol.
[COMMAND CONTROL]	Set to [ON] when you control the projector using control commands. Refer to “Control commands via LAN” (➔ page 207).
[COMMAND PORT]	Set the port number used for command control.
[Crestron Connected(TM)]	Set to [ON] when you control the projector using Crestron Connected™ of Crestron Electronics, Inc.
[STORE]	Save the current network control settings.

- 4) Press ▲▼ to select [STORE], and press the <ENTER> button.
- 5) When the confirmation screen is displayed, press ◀▶ to select [OK], and press the <ENTER> button.

[Panasonic APPLICATION]

(Only in the projector mode)

Configure the settings of the functions used when devices are connected to the projector via LAN using Panasonic's network application software.

Setting [LIVE MODE CUT IN]

Set whether to accept live mode cut-in by another user during live mode processing (image transfer) by “Wireless Manager ME6.2” or image distribution by “Multi Projector Monitoring & Control Software”.

- 1) Press ▲▼ to select [Panasonic APPLICATION].
- 2) Press the <ENTER> button.
 - The [Panasonic APPLICATION] screen is displayed.
- 3) Press ▲▼ to select [LIVE MODE CUT IN].

4) Press ◀▶ to switch the item.

- The items will switch each time you press the button.

[OFF]	Set this item to prohibit live mode cut-in by “Wireless Manager ME6.2” or image distribution by “Multi Projector Monitoring & Control Software”.
[ON]	Set this item to allow live mode cut-in by “Wireless Manager ME6.2” or image distribution by “Multi Projector Monitoring & Control Software”.

Note

- If you use “Multi Projector Monitoring & Control Software” and “Wireless Manager ME6.2” at the same time on the same computer, simultaneous image distribution function of “Multi Projector Monitoring & Control Software” may not work properly. To use them at the same time, use each of the software on separate computers.

Setting [MULTI-LIVE]

Switch the display to multi-live mode when images are to be transferred from multiple computers to the projector using “Wireless Manager ME6.2”.

Refer to the Operating Instructions of “Wireless Manager ME6.2” for details. Multi-live mode can be used with Panasonic’s image transfer application software that supports iPad/iPhone/iPod touch, and Android terminals. Refer to the following URL for image transfer application software that supports iPad/iPhone/iPod touch, and Android terminals.

<http://panasonic.net/avc/projector/>

- 1) Press ▲▼ to select [Panasonic APPLICATION].
- 2) Press the <ENTER> button.
 - The [Panasonic APPLICATION] screen is displayed.
- 3) Press ▲▼ to select [MULTI-LIVE], and press the <ENTER> button.
 - The projector is switched to multi-live mode.
 - The items will switch each time you select [MULTI-LIVE].
 - The style switches to 4-screen multi, 4-screen index, and 16-screen index in order.

Setting [PASSWORD]

By setting the projector to require password entry when a device is connected, you can prevent image cut-in due to wrong external connections.

- 1) Press ▲▼ to select [Panasonic APPLICATION].
- 2) Press the <ENTER> button.
 - The [Panasonic APPLICATION] screen is displayed.
- 3) Press ▲▼ to select [PASSWORD].
- 4) Press ◀▶ to switch the item.
 - The items will switch each time you press the button.

[OFF]	Disables password entry.
[ON]	Enables password entry.

Note

- When you connect a device to the projector using “Wireless Manager ME6.2”, setting [ON] to require password entry is recommended.
- When you use functions of “Multi Projector Monitoring & Control Software” for simultaneous image distribution or deleting distributed images, images cannot be distributed to the projector on which [PASSWORD] is set to [ON]. To use those image distribution functions, set it to [OFF].

Performing [PASSWORD CHANGE]

Set or change the password to connect to the projector.

- 1) Press ▲▼ to select [Panasonic APPLICATION].
- 2) Press the <ENTER> button.
 - The [Panasonic APPLICATION] screen is displayed.

- 3) Press ▲▼ to select [PASSWORD CHANGE].
- 4) Press the <ENTER> button.
 - The [PASSWORD CHANGE] screen is displayed.
- 5) Press ▲▼◀▶ to select a character, and press the <ENTER> button to enter.
- 6) Press ▲▼◀▶ to select [OK], and press the <ENTER> button.
 - To cancel, select [CANCEL].

Note

- Up to eight characters can be set for a password.
- A password is not set in factory default settings. Since connection without password entry is available even when [PASSWORD] is set to [ON], be sure to set a password in [PASSWORD CHANGE] if you set [PASSWORD] to [ON].
- Change the password periodically and make it hard to guess.

[NETWORK STATUS]

Display the status of the projector network.

- 1) Press ▲▼ to select [NETWORK STATUS].
- 2) Press the <ENTER> button.
 - The [NETWORK STATUS] screen is displayed.
- 3) Press ◀▶ to switch the pages.
 - The page will change each time you press the button.

[PROJECTOR NAME]	Displays the projector name set on the projector. The projector name can be changed to a desired name. (➔ page 77)	
[NETWORK ID]	Displays the network ID (fixed) given to the projector.	
[WIRED LAN]	Displays the network information of the wired LAN set on the projector.	
	[DHCP]	Displays the status of use of DHCP server.
	[IP ADDRESS]	Displays the IP address.
	[SUBNET MASK]	Displays the subnet mask.
	[DEFAULT GATEWAY]	Displays the default gateway.
	[DNS1]	Displays the address of the primary DNS server.
	[DNS2]	Displays the address of the secondary DNS server.
	[MAC ADDRESS]	Displays the MAC address of wired LAN.
[WIRELESS LAN]	Displays the network information of the wireless LAN set on the projector.	
	[ANTENNA LEVEL]	Displays the signal status of wireless LAN.
	[NETWORK]	Displays the connection method of wireless LAN.
	[CHANNEL]	Displays the channel used for wireless LAN.
	[SSID]	Displays the string of SSID.
	[AUTHENTICATION]	Displays the user authentication method.
	[EAP]	Displays the type of EAP.
	[ENCRYPTION]	Displays the encryption method.
	[DEFAULT KEY]	Displays the number of the default key.
	[DHCP]	Displays the status of use of DHCP server.
	[IP ADDRESS]	Displays the IP address.
	[SUBNET MASK]	Displays the subnet mask.
	[DEFAULT GATEWAY]	Displays the default gateway.
	[DNS1]	Displays the address of the primary DNS server.
	[DNS2]	Displays the address of the secondary DNS server.
[MAC ADDRESS]	Displays the MAC address of wireless LAN.	

Note

- When [DISABLE] is selected in the [NETWORK] menu → [WIRELESS LAN] (➔ page 78) and an item other than [WIRELESS LAN] is selected in [Art-Net] (➔ page 83), the wireless LAN page on the [NETWORK STATUS] screen is not displayed.

[Art-Net]

Make settings to use the Art-Net function.

- 1) Press ▲▼ to select [Art-Net].
- 2) Press ◀▶ to switch the item.
 - The items will switch each time you press the button.

[OFF]	Disables the Art-Net function.
[WIRED LAN]	Uses the Art-Net function with wired LAN connection.
[WIRELESS LAN]	Uses the Art-Net function with wireless LAN connection.

Note

- Refer to “Setting address for [WIRED LAN]” (➔ page 84) or “Setting address for [WIRELESS LAN]” (➔ page 85) for how to set the IP address.
- If [Art-Net] is set to other than [OFF], the [NETWORK] menu → [WIRED LAN] (➔ page 77) or [WIRELESS LAN] (➔ page 78) is disabled.
- If the string of SSID exceeds 16 characters, the SSID is displayed in two lines.

Setting address for [WIRED LAN]

- 1) Press ▲▼ to select [Art-Net].
- 2) Press ◀▶ to select [WIRED LAN].
- 3) Press the <ENTER> button.
 - The [Art-Net (WIRED LAN)] screen is displayed.
- 4) Press ▲▼ to select [DEVICE IP ADDRESS].
- 5) Press ◀▶ to switch the item.
 - The items will switch each time you press the button.

[2.x.x.x]	Sets the IP address to 2.x.x.x automatically.
[10.x.x.x]	Sets the IP address to 10.x.x.x automatically.
[MANUAL]	Sets the IP address manually.

- 6) Press ▲▼ to select each item, and change the settings according to the operation instructions of the menu.

[NET]	Enter the net setting of the control console to be connected to the projector.
[SUB NET]	Enter the subnet setting of the control console to be connected to the projector.
[UNIVERSE]	Enter the universe setting of the control console to be connected to the projector.
[START ADDRESS]	Enter a start address where the projector processes Art-Net.

- When [2.x.x.x] or [10.x.x.x] is selected in Step 5), proceed to Step 8).

- 7) Press ▲▼ to select each item, and change the settings according to the operation instructions of the menu.

[DHCP]	Set to [ON] when obtaining an IP address automatically using a DHCP server. Set to [OFF] when not using a DHCP server.
[IP ADDRESS]	Enter the IP address when not using a DHCP server.
[SUBNET MASK]	Enter the subnet mask when not using a DHCP server.
[DEFAULT GATEWAY]	Enter the default gateway address when not using a DHCP server.
[DNS1]	Enter the primary DNS server address when not using a DHCP server.
[DNS2]	Enter the secondary DNS server address when not using a DHCP server.

- 8) Press ▲▼ to select [STORE], and press the <ENTER> button.
- 9) When the confirmation screen is displayed, press ◀▶ to select [OK], and press the <ENTER> button.

Note

- When the network address is changed in the [NETWORK] menu → [WIRED LAN] (➔ page 77), the address is reflected in the address for [MANUAL] of this [WIRED LAN] setting.

Setting address for [WIRELESS LAN]

- 1) Press ▲▼ to select [Art-Net].
- 2) Press ◀▶ to select [WIRELESS LAN].
- 3) Press the <ENTER> button.
 - The [Art-Net (WIRELESS LAN)] screen (1/2) is displayed.
- 4) Press ▲▼ to select [DEVICE IP ADDRESS].
- 5) Press ◀▶ to switch the item.
 - The items will switch each time you press the button.

[2.x.x.x]	Sets the IP address to 2.x.x.x automatically.
[10.x.x.x]	Sets the IP address to 10.x.x.x automatically.
[MANUAL]	Sets the IP address manually.

- 6) Press ▲▼ to select each item, and change the settings according to the operation instructions of the menu.

[NET]	Enter the net setting of the control console to be connected to the projector.
[SUB NET]	Enter the subnet setting of the control console to be connected to the projector.
[UNIVERSE]	Enter the universe setting of the control console to be connected to the projector.
[START ADDRESS]	Enter a start address where the projector processes Art-Net.

- When [2.x.x.x] or [10.x.x.x] is selected in Step 5), proceed to Step 8).

- 7) Press ▲▼ to select each item, and change the settings according to the operation instructions of the menu.

[DHCP]	Set to [ON] when obtaining an IP address automatically using a DHCP server. Set to [OFF] when not using a DHCP server.
[IP ADDRESS]	Enter the IP address when not using a DHCP server.
[SUBNET MASK]	Enter the subnet mask when not using a DHCP server.
[DEFAULT GATEWAY]	Enter the default gateway address when not using a DHCP server.
[DNS1]	Enter the primary DNS server address when not using a DHCP server.
[DNS2]	Enter the secondary DNS server address when not using a DHCP server.

- 8) Press ▲▼ to select [NEXT], and press the <ENTER> button.
 - The [Art-Net (WIRELESS LAN)] screen (2/2) is displayed.
- 9) Press ▲▼ to select each item, and change the settings according to the operation instructions of the menu.

[SSID]	Enter the same string as the SSID registered to the access point.	
[AUTHENTICATION]	Select the user authentication method used in the network to which the projector is connected.	
	[OPEN]	Select this item when the authentication method of the access point is Open System.
	[SHARED]	Select this item when the authentication method of the access point is Shared Key.
	[WPA-PSK]	Select this item when the authentication method of the access point is WPA-PSK.
	[WPA2-PSK]	Select this item when the authentication method of the access point is WPA2-PSK.
	[WPA-EAP/WPA2-EAP]	Select this item when the authentication method of the access point is WPA-EAP/WPA2-EAP.
	[WPA-EAP]	Select this item when the authentication method of the access point is WPA-EAP.
[WPA2-EAP]	Select this item when the authentication method of the access point is WPA2-EAP.	

[ENCRYPTION]		Select the encryption method used for the communication between the projector and the network.
	[NONE]	Select this item not to use encryption. It can be selected only when [AUTHENTICATION] is set to [OPEN] or [SHARED].
	[WEP]	Select this item when the encryption method is WEP.
	[TKIP]	Select this item when the encryption method is TKIP. It can be selected only when [AUTHENTICATION] is set to [WPA-PSK], [WPA2-PSK], [WPA-EAP], or [WPA2-EAP].
	[AES]	Select this item when you use AES for the encryption method. It can be selected only when [AUTHENTICATION] is set to [WPA-PSK], [WPA2-PSK], [WPA-EAP], or [WPA2-EAP].
[DEFAULT KEY]		Set a number from 1 to 4 for the default key. It can be selected only when [AUTHENTICATION] is set to [OPEN] or [SHARED], and the encryption method is [WEP].
[KEY1] - [KEY4]		Set WEP key to the key number selected in [DEFAULT KEY]. It can be selected only when [AUTHENTICATION] is set to [OPEN] or [SHARED], and the encryption method is [WEP]. You can set a 64-bit or 128-bit WEP key. Enter five single-byte alphanumeric characters (10 digits for hexadecimal) for 64-bit, or enter 13 single-byte alphanumeric characters (26 digits for hexadecimal) for 128-bit.
[KEY]		Set the key. It can be selected when [AUTHENTICATION] is set to [WPA-PSK] or [WPA2-PSK]. Enter 8 to 63 alphanumeric characters or 64-digit hexadecimal.
[EAP]		Select the EAP set for RADIUS server. It can be selected when [AUTHENTICATION] is set to [WPA-EAP/WPA2-EAP], [WPA-EAP], or [WPA2-EAP]. The types of EAP that can be selected are as follows. [PEAP(MS-CHAPv2)], [PEAP(GTC)], [EAP-TTLS(MD5)], [EAP-TTLS(MS-CHAPv2)], [EAP-FAST(MS-CHAPv2)], [EAP-FAST(GTC)]
[USER NAME]		Enter the user name to be used for authentication in single-byte alphanumeric characters (space not included, 64 characters at the maximum). It can be selected when [AUTHENTICATION] is set to [WPA-EAP/WPA2-EAP], [WPA-EAP], or [WPA2-EAP].
[PASSWORD]		Enter the password to be used for authentication in single-byte alphanumeric characters (64 characters at the maximum). It can be selected when [AUTHENTICATION] is set to [WPA-EAP/WPA2-EAP], [WPA-EAP], or [WPA2-EAP].

10) Press ▲▼ to select [STORE], and press the <ENTER> button.

- Press ▲▼ to select [RETURN] and then press the <ENTER> button to return to the [Art-Net (WIRELESS LAN)] screen (1/2).

11) When the confirmation screen is displayed, press ◀▶ to select [OK], and press the <ENTER> button.

Note

- When [USER3] is selected in the [NETWORK] menu → [WIRELESS LAN] (➡ page 78) and the network setting is changed, the address is reflected in the network setting for this [WIRELESS LAN] setting.
- If the string of SSID exceeds 16 characters, the SSID is displayed in two lines.

[DISPLAY OPTION] menu

(Only in the projector mode)

On the menu screen, select [DISPLAY OPTION] from the main menu, and select an item from the sub-menu.

Refer to “Navigating through the menu” (➔ page 55) for the operation of the menu screen.

- After selecting the item, press ▲▼◀▶ to set.

[HDMI IN]

Switch the setting when the external device is connected to the <HDMI IN> terminal of the projector and the image is not projected correctly.

- 1) Press ▲▼ to select [HDMI IN].
- 2) Press the <ENTER> button.
 - The [HDMI IN] screen is displayed.
- 3) Press ◀▶ to switch the item.
 - The items will switch each time you press the button.

[AUTO]	Automatically sets the signal level.
[64-940]	Select this item when the HDMI terminal output of an external device (such as a blu-ray disc player) is connected to the <HDMI IN> terminal.
[0-1023]	Select this item when the DVI terminal output of an external device (such as a computer) is connected to the <HDMI IN> terminal via a conversion cable or similar cable. Select it also when the HDMI terminal output of a computer or other device is connected to the <HDMI IN> terminal.

Note

- The optimal setting varies depending on the output setting of the connected external device. Refer to the operating instructions of the external device regarding the output of the external device.
- The HDMI signal level is displayed for 30 bits of input.

[ON-SCREEN DISPLAY]

Set the on-screen display.

Setting [INPUT GUIDE]

Set whether to display the input guide (currently selected input name, signal name, connection method of wireless LAN, projector name, and network ID) on the projected image when the input is switched.

- 1) Press ▲▼ to select [ON-SCREEN DISPLAY].
- 2) Press the <ENTER> button.
 - The [ON-SCREEN DISPLAY] screen is displayed.
- 3) Press ▲▼ to select [INPUT GUIDE].
- 4) Press ◀▶ to switch the item.
 - The items will switch each time you press the button.

[ON]	Displays the input guide.
[OFF]	Hides the input guide.

Note

- When [INPUT GUIDE] is set to [ON], a guide that corresponds to the input guide (currently selected mode, connection method of wireless LAN, projector name, and network ID) is displayed when the mode is switched to the lighting mode. If [INPUT GUIDE] is set to [OFF], the guide will not be displayed the same way as the input guide.

Setting [WARNING MESSAGE]

Set the display/hide of the warning message.

- 1) Press ▲▼ to select [ON-SCREEN DISPLAY].

- 2) Press the <ENTER> button.
 - The [ON-SCREEN DISPLAY] screen is displayed.
- 3) Press ▲▼ to select [WARNING MESSAGE].
- 4) Press ◀▶ to switch the item.
 - The items will switch each time you press the button.

[ON]	Displays the warning message.
[OFF]	Hides the warning message.

[AV MUTE]

Turn off lighting or projection and audio output temporarily when the projector is not used for a certain period of time.

- 1) Press ▲▼ to select [AV MUTE].
- 2) Press the <ENTER> button.
 - Press the <RETURN> button to release.

Note

- The power indicator <ON (G)/STANDBY (R)> blinks slowly while in AV mute mode.

[DISPLAY LANGUAGE] menu

On the menu screen, select [DISPLAY LANGUAGE] from the main menu, and display the sub-menu. Refer to “Navigating through the menu” (➔ page 55) for the operation of the menu screen.

- Press ▲▼ to select a language, and press the <ENTER> button to set.

Changing the display language

You can select the language of the on-screen display.

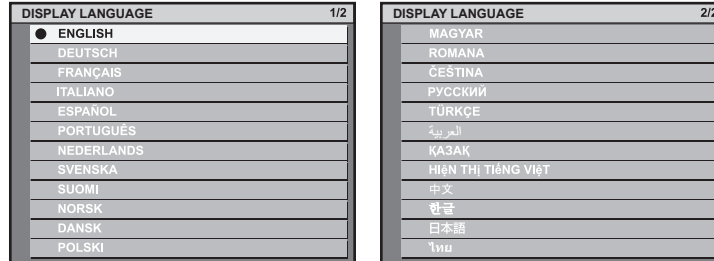

- Various menus, settings, adjustment screens, control button names, etc., are displayed in the selected language.
- The language can be changed to English, German, French, Italian, Spanish, Portuguese, Dutch, Swedish, Finnish, Norwegian, Danish, Polish, Hungarian, Romanian, Czech, Russian, Turkish, Arabic, Kazakh, Vietnamese, Chinese, Korean, Japanese, and Thai.

Note

- The on-screen display language of the projector is set to English by default as well as when [ALL USER DATA] (➔ page 76) in [INITIALIZE] is executed.

[SECURITY] menu

On the menu screen, select [SECURITY] from the main menu, and select an item from the sub-menu. Refer to “Navigating through the menu” (➔ page 55) for the operation of the menu screen.

- When the projector is used for the first time
Initial password: Press ▲▶▼◀▲▶▼◀ in order, and press the <ENTER> button.
- After selecting the item, press ▲▼◀▶ to set.

Attention

- When you select the [SECURITY] menu and press the <ENTER> button, entering a password is required. Enter the preset password and then continue operations of the [SECURITY] menu.
- When the password has been changed previously, enter the changed password, and press the <ENTER> button.

Note

- The entered password is displayed with * marks on the screen.
- An error message is displayed on the screen when the entered password is incorrect. Re-enter the correct password.

[SECURITY PASSWORD]

Display the [SECURITY PASSWORD] screen when the projector is turned on and projection is started from the status that power was not supplied. If an incorrect password has been entered, operations other than the power <⏻/▶> button and the <AV MUTE> button become disabled.

- 1) Press ▲▼ to select [SECURITY PASSWORD].
- 2) Press ◀▶ to switch the item.
 - The items will switch each time you press the button.

[OFF]	Disables the security password entry.
[ON]	Enables the security password entry.

Note

- [SECURITY PASSWORD] is set to [OFF] at the time of purchase or when [ALL USER DATA] in [INITIALIZE] (➔ page 76) has been performed.
- Change the password periodically that is hard to guess.
- Security password is enabled when [SECURITY PASSWORD] is set to [ON] and the power supply to the projector is disconnected by turning off the power supply of the interior wiring or disconnecting the plug of the power cord from the outlet.

[SECURITY PASSWORD CHANGE]

Change the security password.

- 1) Press ▲▼ to select [SECURITY PASSWORD CHANGE].
- 2) Press the <ENTER> button.
 - The [SECURITY PASSWORD CHANGE] screen is displayed.
- 3) Press ▲▼◀▶ and the number (<1> - <6>) buttons to set the password.
 - Up to eight button operations can be set.
- 4) Press the <ENTER> button.
- 5) Re-enter the password for the confirmation.
- 6) Press the <ENTER> button.

Note

- The entered password is displayed with * marks on the screen.
- If the remote control is lost after a security password has been set, initialization of the security password is required. Consult your dealer for the method of initialization.

[TEST PATTERN] menu

(Only in the projector mode)

On the menu screen, select [TEST PATTERN] from the main menu.

Refer to “Navigating through the menu” (➔ page 55) for the operation of the menu screen.

- Press ◀▶ to switch.

[TEST PATTERN]

Display the test pattern built-in to the projector.

The settings for [COLOR TEMPERATURE], [ASPECT], and [KEystone] are not reflected in the test pattern.

1) Press ◀▶ to switch the [TEST PATTERN] item.

- The items will switch each time you press the button.

Menu screen + All white	Displays test patterns with the menu screen. Select a test pattern so that it is easy to make various adjustments.
Menu screen + All black	
Menu screen + Color bar (vertical)	
Menu screen + Cross hatch	
Menu screen + Entry screen	Displays the menu screen and input signal. Built-in test patterns are not displayed.

Note

- Pressing the <MENU> or <RETURN> button while the test pattern is displayed hides the on-screen menu.
- If the on-screen menu is hidden while the test pattern is displayed, the test pattern is not switched even if ◀▶ are pressed. To switch the test pattern, operate with the on-screen displayed.

Chapter 5 Operations

This chapter describes how to use each function.

Memory Viewer function

Memory Viewer is a function that allows projection of still images or movies stored in an SD card.

Files that can be played back with the Memory Viewer function

The following still image/movie files can be played back on the projector.

	Extension	Format	Restriction
Still image	jpg/jpeg	JPEG	Number of pixels: Maximum 8 000 x 8 000 (For progressive JPEG, maximum 4 096 x 4 096) YUV format: Only YUV444, YUV422, and YUV411 supported Color mode: Only RGB supported
	bmp	Windows Bitmap	Number of pixels: Maximum 2 000 x 2 000 (1-bit, 4-bit, 8-bit, 16-bit, 24-bit, and 32-bit supported) Following formats are not supported. Run-length encoding, Bit fields, Top to bottom, Transparent data

	Extension	Codec		Restriction*1	
		Video	Audio	Video	Audio
Movie	mov	H.264/MPEG-4 AVC Motion JPEG	AAC Linear PCM	Resolution: Maximum 1 920 x 1 080 Minimum 240 x 180 Frame rate: Maximum 30 fps Bit rate: Maximum 40 Mbps	Sample rate: Maximum 48 kHz (For Linear PCM, maximum 16 kHz) Channel: Maximum 2 ch Bit rate: Maximum 384 kbps
	avi	H.264/MPEG-4 AVC Motion JPEG MPEG-4	MPEG-1/2 Audio Layer-3 (MP3) AAC Linear PCM		
	mp4	H.264/MPEG-4 AVC MPEG-4	AAC MPEG-4 AAC-LC		
	mpg/mpeg	MPEG-2	MPEG-1/2 Audio Layer-2		
	wmv	WMV9	WMA		

*1 Following movie files are not supported.

- Files with the video codec of WMV7, WMV8, DivX, or Xvid
- Uncompressed video
- Multi-angle video
- Files with the profile of Advanced Simple Profile @ Level 0 or Advanced Simple Profile @ Level 1

Note

- Some information for still image/movie files can be viewed with a computer where relevant files are accessible.

Operation example

– For Windows computer

1. Right-click a file, and click [Properties].
2. Click the [Details] tab.

– For Mac

1. Click a file while holding down the “Control” key, and click [Get Info].
2. Click [More Info].

- File size that can be played back is 2 GB at the maximum.
- Files protected by DRM (Digital Rights Management) cannot be played back.
- The total number of folders/files that can be recognized on the projector is 1 000 at the maximum. If there are 1 001 or more folders/files, an error message is displayed.
- Some files cannot be played back even if the formats are supported.
- Use the SD card with high data transfer speed. If the data transfer speed is slow, movie recorded in the SD card may not be played back properly or it may take time to display a still image. (Speed class: Class 10 recommended)
- Refer to “Cards that can be used with the projector” (➔ page 49) for SD cards that can be used with the projector.

Displaying the Memory Viewer screen

- 1) **Insert an SD card in which still image or movie files are stored to the SD card slot.**
 - Refer to “Using SD cards” (➔ page 49) for handling of SD cards.
- 2) **Press the <MEMORY VIEWER> button.**
 - The Memory Viewer screen (thumbnail or list view) is displayed.

- The cursor is placed on the folder list on the left of the screen. (Background color: orange)

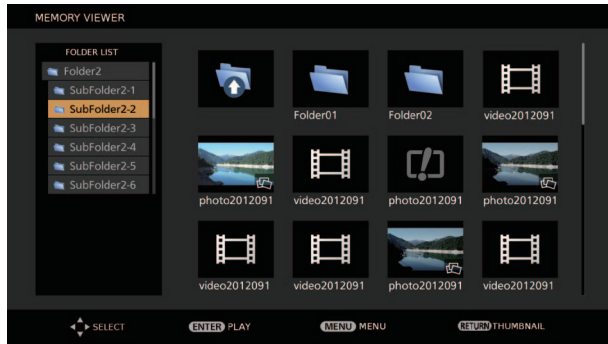

Example in thumbnail view



Example in list view

Note

- The display view of the Memory Viewer screen (thumbnail or list view) can be set from the [MEMORY VIEWER] menu → [VIEW] (➔ page 66).

Operating the Memory Viewer screen

This section describes an example of screen operations after the Memory Viewer screen is displayed.

For thumbnail view

- 1) Press **▲▼** to select a folder, and press the **<ENTER>** button.
 - If there are folders in lower hierarchy, they are unfolded and displayed in the folder list on the upper left of the screen.
 - The selected folder (cursor position) is highlighted in orange background color.
- 2) Press the **<RETURN>** button.
 - The cursor moves from the folder list on the left of the screen to the thumbnail view area on the right. (Background color: yellow)
- 3) Press **▲▼◀▶** to select a file.
 - The information on the still image or movie file is displayed in the information area on the lower left of the screen.

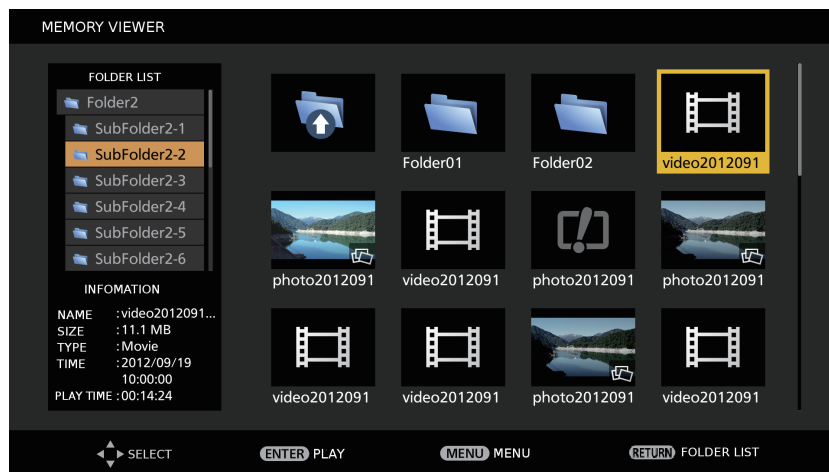

- 4) Press the **<ENTER>** button.
 - Playback starts in the full-screen display.
 - Refer to “Playing back still images” (➔ page 96) or “Playing back movies” (➔ page 97) for detailed playback procedure.
- 5) Press the **<RETURN>** button to end playback.
 - Full-screen display ends and the Memory Viewer screen (thumbnail view) is displayed.
 - To subsequently play back another file, perform Steps 1) to 4).

Note

- While the Memory Viewer screen is displayed, every press of the <RETURN> button moves the cursor between the folder list and thumbnail/list view area.
- The display order of thumbnails follows the settings in the [MEMORY VIEWER] menu → [SORT] (➔ page 66).
- Still image/movie files in the specified folder can be played back by pressing the number (<1> - <6>) buttons on the remote control. For the advance setting or operation, refer to “Direct playback” (➔ page 99).

For list view

- 1) **Press ▲▼ to select a folder, and press the <ENTER> button.**
 - Folders in lower hierarchy are unfolded and displayed in the folder list on the upper left of the screen.
 - The selected folder (cursor position) is highlighted in orange background color.
- 2) **Press the <RETURN> button.**
 - The cursor moves from the folder list on the upper left of the screen to the list view area on the right. (Background color: yellow)
- 3) **Press ▲▼ to select a file.**
 - The thumbnail of the selected still image or movie file is displayed in the area on the lower left of the screen.

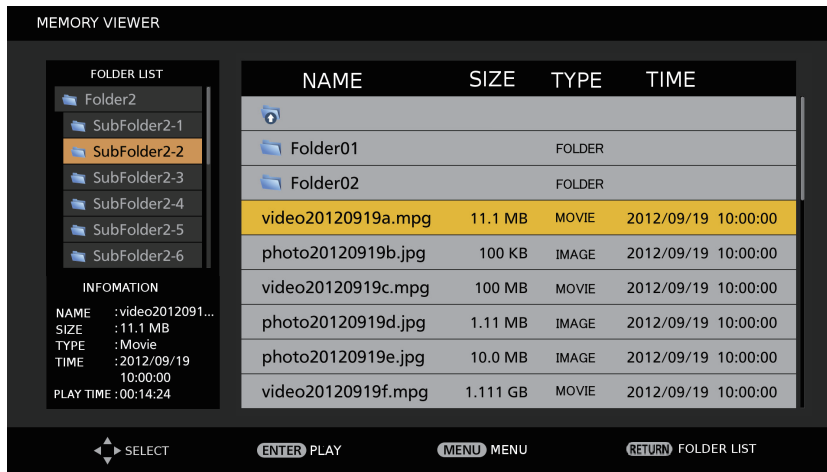

- 4) **Press the <ENTER> button.**
 - Playback starts in the full-screen display.
 - Refer to “Playing back still images” (➔ page 96) or “Playing back movies” (➔ page 97) for detailed playback procedure.
- 5) **Press the <RETURN> button to end playback.**
 - Full-screen display ends and the Memory Viewer screen (list view) is displayed.
 - To subsequently play back another file, perform Steps 1) to 4).

Note

- While the Memory Viewer screen is displayed, every press of the <RETURN> button moves the cursor between the folder list and thumbnail/list view area.
- The display order in the list follows the settings in the [MEMORY VIEWER] menu → [SORT] (➔ page 66).
- Still image/movie files in the specified folders can be played back by pressing the number (<1> - <6>) buttons on the remote control. For the advance setting or operation, refer to “Direct playback” (➔ page 99).

Playing back still images

This section describes the procedure using an operation example on the Memory Viewer screen in thumbnail view.

Playback on the Memory Viewer screen in list view can be performed with the same procedure except for the file selection.



} Operation guide

Example of display during automatic playback (still image)

When automatic playback is enabled

This section describes the operations when the [MEMORY VIEWER] menu → [AUTOPLAY] (➔ page 66) is set to [ON].

In this case, all still image files in the same folder are played back automatically according to the settings in the [MEMORY VIEWER] menu (➔ page 66) → [INTERVAL] and [EFFECT].

1) Press ▲▼◀▶ to select a file to be projected first from the thumbnails, and press the <ENTER> button.

- Playback starts in the full-screen display.
- Pressing the <ENTER> button during playback pauses automatic playback. Pressing it again resumes playback.
- After playback ends, playback of the next file starts.
- Pressing ▶ during playback skips the file being played back and continues automatic playback from the next file.
- Pressing ◀ during playback returns playback to the previous file and continues automatic playback.
- Pressing ▲ during playback rotates the image 90° clockwise with the aspect ratio maintained.
- Pressing ▼ during playback rotates the image 90° counterclockwise with the aspect ratio maintained.

2) Press the <RETURN> button.

- Automatic playback ends and the Memory Viewer screen (thumbnail view) returns.

When automatic playback is disabled

This section describes the operations when the [MEMORY VIEWER] menu → [AUTOPLAY] (➔ page 66) is set to [OFF]. In this case, files to be projected are selected and played back one by one.

1) Press ▲▼◀▶ to select a file from the thumbnails, and press the <ENTER> button.

- The selected still image is played back in the full-screen display.
- Pressing ▶ plays back the next file.
- Pressing ◀ plays back the previous file.

2) Press the <RETURN> button.

- Full-screen display ends and the Memory Viewer screen in thumbnail view returns.

Note

- If the number of recording pixels is less than 1 280 x 800, the image is enlarged with the aspect ratio maintained.
- If the number of recording pixels is more than 1 280 x 800, the image is reduced with the aspect ratio maintained.

- The playback order follows the display order set in the [MEMORY VIEWER] menu → [SORT] (➔ page 66).
Also in the cases where still image and movie files both exist in the same folder, they are played back according to the [SORT] setting.
- The operation guide on the lower part of the playback screen can be hidden by setting the [MEMORY VIEWER] menu → [GUIDE] (➔ page 67) to [OFF].

Playing back movies

This section describes the procedure using an operation example on the Memory Viewer screen in thumbnail view.

Playback on the Memory Viewer screen in list view can be performed with the same procedure except for the file selection.



Example of display during fast-forward playback (x10 speed)

When automatic playback is enabled

This section describes the operations when the [MEMORY VIEWER] menu → [AUTOPLAY] (➔ page 66) is set to [ON].

In this case, all movie files in the same folder are played back automatically.

- 1) **Press ▲▼◀▶ to select a file to be projected first from the thumbnails, and press the <ENTER> button.**
 - Playback starts in the full-screen display.
 - Pressing the <ENTER> button during playback pauses playback. Pressing it again resumes playback from the position where the playback has been stopped.
 - After playback ends, playback of the next file starts.
 - Pressing ▶ during playback performs fast-forward playback. Every press of ▶ increases the speed. (3 levels)
 - Pressing ◀ during playback performs rewind playback. Every press of ◀ increases the speed. (3 levels)
 - Pressing ▲ plays back the file being played back from the beginning. (cue)
 - Pressing ▶ during pause skips the file being played back and starts playback of the next file.
 - Pressing ◀ during pause returns playback to the previous file and starts playback.
- 2) **Press the <RETURN> button.**
 - Automatic playback ends and the Memory Viewer screen (thumbnail view) returns.

When automatic playback is disabled

This section describes the operations when the [MEMORY VIEWER] menu → [AUTOPLAY] (➔ page 66) is set to [OFF].

In this case, files to be projected are selected and played back one by one.

- 1) **Press ▲▼◀▶ to select a file from the thumbnails, and press the <ENTER> button.**
 - Playback starts in the full-screen display.
 - Pressing the <ENTER> button during playback pauses playback. Pressing it again resumes playback from the position where the playback has been stopped.
 - After playback ends, playback goes into pause state at the beginning of the file.

- Pressing ► during playback performs fast-forward playback. Every press of ► increases the speed. (3 levels)
- Pressing ◀ during playback performs rewind playback. Every press of ◀ increases the speed. (3 levels)
- Pressing ▲ plays back the file being played back from the beginning. (cue)
- Pressing ► during pause skips the file being played back and starts playback of the next file.
- Pressing ◀ during pause returns playback to the previous file and starts playback.

2) Press the <RETURN> button.

- Full-screen display ends and the Memory Viewer screen in thumbnail view returns.

Note

- If the number of recording pixels is less than 1 280 x 800, the image is enlarged with the aspect ratio maintained.
- If the number of recording pixels is more than 1 280 x 800, the image is reduced with the aspect ratio maintained.
- The playback order follows the display order set in the [MEMORY VIEWER] menu → [SORT] (➡ page 66).
Also in the cases where still image and movie files both exist in the same folder, they are played back according to the [SORT] setting.
- The time bar of the operation guide on the lower part of the playback screen can be hidden by setting the [MEMORY VIEWER] menu → [GUIDE] (➡ page 67) to [OFF].

Resume playback

When automatic playback is disabled (the [MEMORY VIEWER] menu → [AUTOPLAY] (➡ page 66) is set to [OFF]), resume playback can be performed.

Resume playback is a function that stops movie playback in the middle and restarts playback from the position where the movie has been stopped the last time when the same file is to be played back next time.

The following operations resume playback from the position where the last playback has been stopped.

- Stopping movie playback in the middle, going back to the Memory Viewer screen, and then selecting the same movie file again and playing it back
- After playing back other movie or still image files, selecting the previous movie file and playing it back

Note

- Resume information (information on the position when movie playback is stopped in the middle) is automatically saved at the time when playback is paused by pressing the <ENTER> button during playback or when full-screen display is ended by pressing the <RETURN> button during playback.
- Resume information (information on the position when movie playback is stopped in the middle) of 50 movie files can be saved. After the 51st movie file is played back, resume information will be deleted in order from the oldest.
- When resume playback is performed, some files may not be played back from the correct position where the last playback has been stopped.
- All resume information are deleted if switching the input to other than Miracast, removing the SD card, setting to standby status while the [SETUP] menu → [STANDBY MODE] (➡ page 72) is set to [ECO], the turning off the power supply of the interior wiring, or disconnecting the plug of the power cord from the outlet.

Playing back still images/movies automatically when the projector is turned on

When the following three conditions are met, playback of still images/movies starts automatically when the projector is turned on.

- Automatic playback is enabled
 - The [MEMORY VIEWER] menu → [AUTOPLAY] (➡ page 66) is set to [ON]
- The input is set to Memory Viewer when the power is turned on to start projection
 - The [SETUP] menu → [STARTUP INPUT SELECT] (➡ page 73) is set to [MEMORY VIEWER]
 - The [SETUP] menu → [STARTUP INPUT SELECT] (➡ page 73) is set to [LAST USED], and the power is turned off with the input set to Memory Viewer
- There are still image/movie files that can be played back with the Memory Viewer function in the root folder of the SD card

Note

- The playback order follows the display order set in the [MEMORY VIEWER] menu → [SORT] (➡ page 66).
Also in the cases where still image and movie files both exist in the same folder, they are played back according to the [SORT] setting.
- To play back still image/movie files automatically when the power supply of the interior wiring is turned on or the plug of the power cord is connected, perform the following setting and operation.
 - Set the [SETUP] menu → [INITIAL STARTUP] (➡ page 72) to [ON]
 - Set the [SETUP] menu → [INITIAL STARTUP] (➡ page 72) to [LAST MEMORY], and turn off the power supply of the interior wiring while projecting or disconnect the plug of the power cord while projecting

Direct playback

Still image/movie files in the specified folders of the SD card can be played back by pressing the number (<1> - <6>) buttons on the remote control. This operation is referred to as direct playback.

Saving files for direct playback

To perform direct playback, still image/movie files must be saved in the specified folders in advance. Saving destinations of files are the folders in the root directory (top-most directory) of the SD card. Name the folders (4 characters in single byte) corresponding to the number (<1> - <6>) buttons on the remote control, as indicated in the following table. If the folder name is different, direct playback cannot be performed.

Number button	<1>	<2>	<3>	<4>	<5>	<6>
Corresponding folder name	R001	R002	R003	R004	R005	R006

Performing direct playback







- 1) **Insert the SD card into the SD card slot.**
 - Refer to “Using SD cards” (➔ page 49) for handling of SD cards.
- 2) **Press the <MEMORY VIEWER> button.**
 - The Memory Viewer screen (thumbnail or list view) is displayed.
- 3) **Press the number (<1> - <6>) buttons on the remote control.**
 - Still image/movie files in the folder corresponding to the number button on the remote control are played back in the full-screen display.

Note







- If the [MEMORY VIEWER] menu → [AUTOPLAY] (➔ page 66) is set to [ON], still image/movie files in the folder corresponding to the number button are played back in the order set in [MEMORY VIEWER] → [SORT] (➔ page 66).
- If the [MEMORY VIEWER] menu → [AUTOPLAY] (➔ page 66) is set to [OFF], among still image/movie files in the folder corresponding to the number button, the first file in the order set in [MEMORY VIEWER] → [SORT] (➔ page 66) is played back.
- If the number (<1> - <6>) buttons on the remote control are pressed during playback in the full-screen display, current playback stops and the still image/movie files in the folder corresponding to the newly pressed number button are played back.
- Even while the Memory Viewer screen (thumbnail or list view) is displayed or the file is played back in full-screen view, direct playback cannot be performed if the on-screen menu (menu screen) is displayed.
- Even when the number (<1> - <6>) buttons on the remote control are pressed, the operation is disabled if the folder corresponding to the pressed number button does not exist or if the files that can be played back with the Memory Viewer are not saved.
- For the operations during playback, refer to “Playing back still images” (➔ page 96) and “Playing back movies” (➔ page 97).

Memory Viewer screen descriptions

The icons on the Memory Viewer screen indicate the following.

	An icon to indicate moving to upper hierarchy. Select it to move to the upper hierarchy.
	An icon to display folders in lower hierarchy. Select it to move to the lower hierarchy.
	An icon to indicate that the file is still image.
	An icon to indicate that the file is movie.
	An icon to indicate that the extension of the file is supported but it cannot be opened.
	Rotates the still image 90° counterclockwise.
	Rotates the still image 90° clockwise.

Chapter 5 Operations — Memory Viewer function

	Indicates that fast-forward playback is being performed in approximately x2 speed. (with audio)
	Indicates that fast-forward playback is being performed in approximately x5 speed.
	Indicates that fast-forward playback is being performed in approximately x10 speed.
	Indicates that playback is being paused.
	Indicates that fast-rewind playback is being performed in approximately x2 speed.
	Indicates that fast-rewind playback is being performed in approximately x5 speed.
	Indicates that fast-rewind playback is being performed in approximately x10 speed.

Network connection

This projector has network function that allows the following by connecting a computer.

- **WEB control**

By accessing to the projector from a computer, you can perform setting, adjustment, status display, etc. of the projector. Refer to “Web control function” (➔ page 105) for details.

- **Miracast**

By connecting the projector to a device that supports Miracast via wireless LAN, you can project the image of the device. Refer to “Miracast function” (➔ page 126) for details.

- **Panasonic APPLICATION**

By using image transfer application software “Wireless Manager ME6.2” that supports Windows computers and Mac, and Panasonic’s image transfer application software that supports iPad/iPhone/iPod touch, and Android terminals, you can transfer images to the projector. Software, “Multi Projector Monitoring & Control Software”, which monitors and controls multiple projectors connected to the LAN is also supported.

For details of “Wireless Manager ME6.2” and “Multi Projector Monitoring & Control Software”, refer to the Operating Instructions of them included in the supplied CD-ROM. Refer to the following URL for image transfer application software that supports iPad/iPhone/iPod touch, and Android terminals.

<http://panasonic.net/avc/projector/>

- **Signage playback**

You can configure the settings for “Signage playback function”, which allows you to project still images and movies stored in an SD card according to registered schedules and slideshow settings. Refer to “Content Manager” (➔ page 127) for details.

- **PJLink**

By using PJLink protocol, you can send inquiries about the operations or status of the projector from a computer. Refer to “Using the PJLink protocol” (➔ page 206) for details.

- **Command control**

By using control commands, you can send inquiries about the operations or status of the projector from a computer. Refer to “Control commands via LAN” (➔ page 207) for details.

When connecting via wired LAN

Connection example

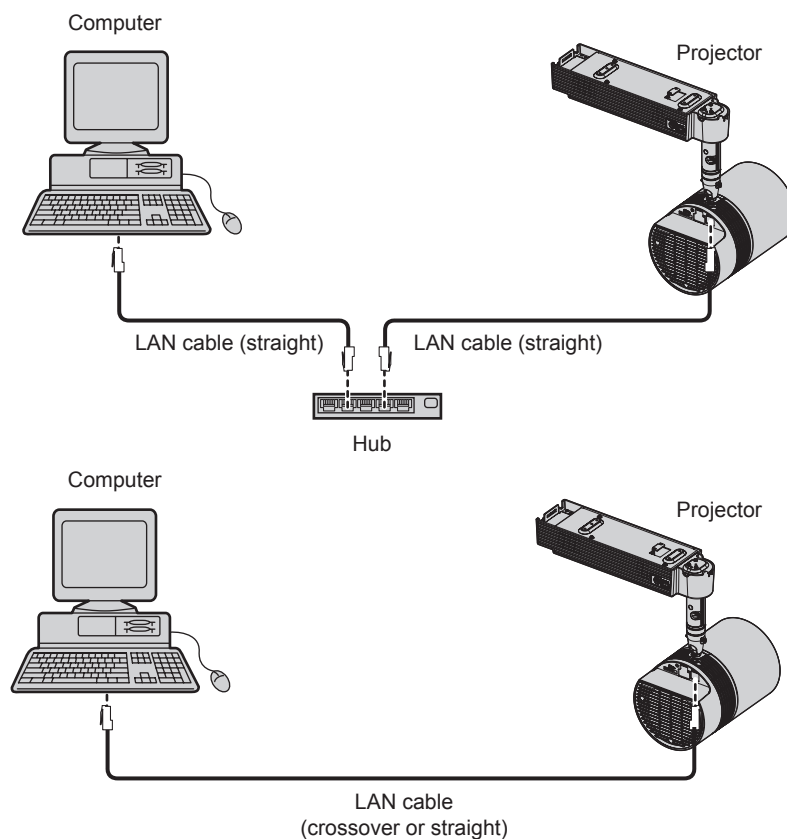

Attention

- When a LAN cable is directly connected to the projector, cabling must be made indoors.

Note

- A LAN cable is required to use the network function via wired LAN.
- Use a straight or crossover LAN cable that is compatible with category 5 or higher. Whether either of straight/crossover cable or both cables can be used differ depending on the system configuration. Consult your network administrator. The projector recognizes the cable type (straight/crossover) automatically.
- Use a LAN cable of 100 m (328'1") or shorter.

Setting for projector

- 1) Connect the projector and a computer using a LAN cable.
- 2) Turn on the projector.
- 3) Press the <MENU> button to open the [NETWORK] menu and configure settings for [WIRED LAN].
 - Refer to [WIRED LAN] (➔ page 77) for details.

Note

- Consult your network administrator before connecting to an existing network.
- The following settings are configured as the factory defaults.

[DHCP]	OFF
[IP ADDRESS]	192.168.10.100
[SUBNET MASK]	255.255.255.0
[DEFAULT GATEWAY]	192.168.10.1
[DNS1]/[DNS2]	None

Setting for computer

- 1) Turn on the computer.
- 2) Configure network settings following the instructions of your network administrator.
 - If the projector is in the factory default settings, configure the network settings of the computer side as follows, and then you can use network functions.

[IP ADDRESS]	192.168.10.101
[SUBNET MASK]	255.255.255.0
[DEFAULT GATEWAY]	192.168.10.1

When connecting via wireless LAN

Connection example

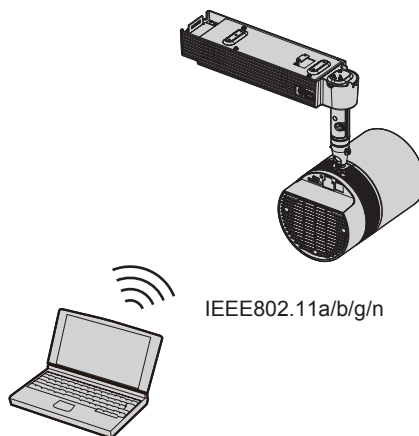

Connection example for image transfer

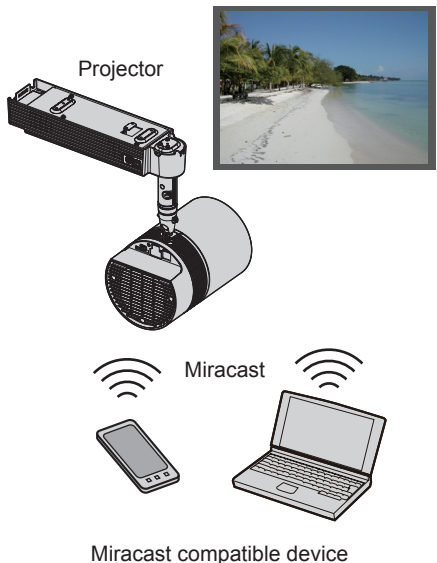
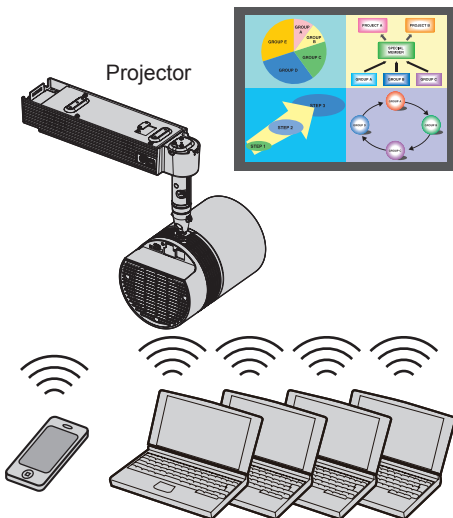
	Miracast	Image transfer application software	
Illustration of connection	(Example) Displaying copyright-protected contents 	(Example) Displaying on multiple screens 	
	Input	Miracast	Panasonic APPLICATION
	Communication method	IEEE802.11a/n	IEEE802.11b/g/n
	Connection method	WPS + Wi-Fi Direct	Panasonic exclusive method + connection by user
	Image transmission method	Miracast	Panasonic exclusive method

Setting for projector

- 1) Turn on the projector.
- 2) Press the <MENU> button to open the [NETWORK] menu and set [WIRELESS LAN] to either of [M-DIRECT], [USER1], [USER2], or [USER3].
- 3) Configure the settings of the connection method selected in Step 2).
 - Refer to [WIRELESS LAN] (➡ page 78) for details.



Note

- Wireless LAN and wired LAN cannot be used in the same segment.
- If multiple devices are to be connected, set IP addresses that do not overlap.
- Enter SSID correctly in single-byte alphanumeric characters.
- “any” or “ANY” cannot be set for SSID.
- This setting is not necessary when connecting Miracast. Refer to “Miracast function” (➡ page 126) for Miracast.
- The following settings are configured as the factory defaults.

[M-DIRECT]	[IP ADDRESS]	192.168.12.100
	[SUBNET MASK]	255.255.255.0
	[SSID]	M-DIRECTxxxx (xxxx stands for the last four-digit number of the network ID.)
	[CHANNEL]	1
	[KEY]	The same character string as SSID

[USER1]/[USER2]/[USER3]	[SSID]	Panasonic Projector
	[DHCP]	OFF
	[IP ADDRESS]	192.168.11.100
	[SUBNET MASK]	255.255.255.0
	[DEFAULT GATEWAY]	192.168.11.1
	[AUTHENTICATION]	Open
	[ENCRYPTION]	None
	[DNS1]/[DNS2]	None

Setting for computer

- 1) Turn on the computer.
- 2) **Configure network settings following the instructions of your network administrator.**
 - If [M-DIRECT] is set on the projector side, set “Obtain an IP address automatically” in the network setting on the computer side.
 - If [USER1] through [USER3] are set on the projector side, follow the instructions of your network administrator and configure each network setting item of your computer and the projector.
- 3) **Connect the computer to the network set for the projector.**
 - For Windows computers, click  in the task tray (lower right of the computer screen). If [M-DIRECT] is set on the projector, select the same name as SSID set for the projector. If [USER1] through [USER3] are set on the projector, select the same name as SSID of your access point.
For Mac, click  in the menu bar (upper right of the computer screen). If [M-DIRECT] is set on the projector, select the same name as SSID set for the projector. If [USER1] through [USER3] are set on the projector, select the same name as SSID of your access point.
 - If the projector is in the default settings and [M-DIRECT] is set, [SSID] is [M-DIRECTxxxx] (xxxx stands for the last four-digit number of the network ID).

Note

- If you use wireless LAN connection utility that is standard for your OS, follow the operation procedure of the utility you use to connect to the network.

Web control function

Using Web control functions, you can perform the following operations from a computer.

- Setting and adjustment of the projector
- Displaying projector status
- Setting of E-mail message sending

The projector supports “Crestron Connected™”, and the following application software of Crestron Electronics, Inc. can be used.

- RoomView Express
- Fusion RV
- RoomView Server Edition

Note

- “Crestron Connected™” is a system of Crestron Electronics, Inc. that collectively manages and controls devices on multiple systems connected to a network using a computer.
- For details of “Crestron Connected™”, refer to the website of Crestron Electronics, Inc. (English only)
URL <http://www.crestron.com>
 To download “RoomView Express”, go to the website of Crestron Electronics, Inc. (English only)
URL <http://www.crestron.com/getroomview>

Computer that can be used for setting

A web browser is required to use the web control function. Confirm that your web browser can be used beforehand.

OS	Compatible web browser
Windows	Internet Explorer 7.0/8.0/9.0/10.0/11.0
Mac OS	Safari 4.0/5.0/6.0/7.0

Accessing from the web browser

- 1) Start up the web browser on the computer.
- 2) Enter the IP address set on the projector into the URL entry field of the web browser.
- 3) Enter the user name and the password.
 - The factory default setting of the user name is user1 (user rights)/admin1 (administrator rights) and the password is panasonic (lower case).

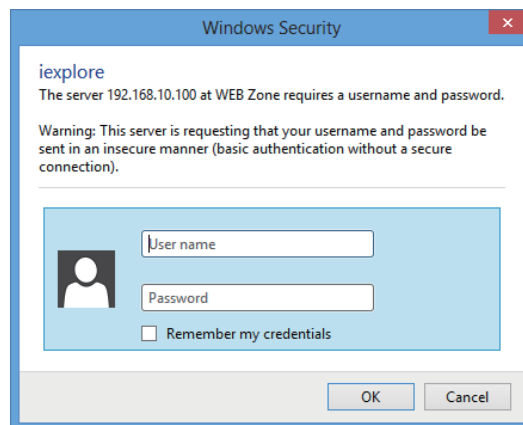

4) Click the [OK] button.

- The [Projector status] page is displayed.

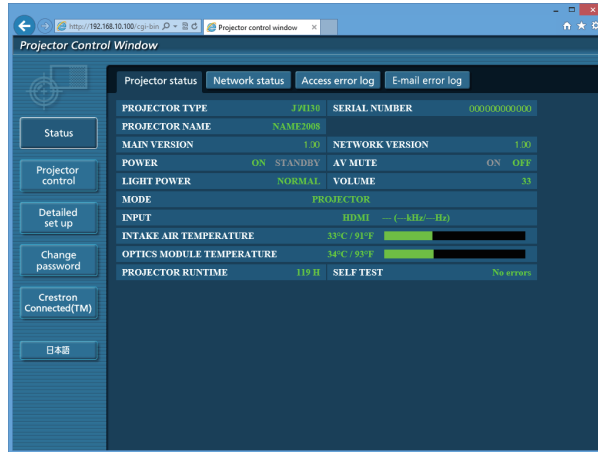

Note

- If you use a web browser to control the projector, set [WEB CONTROL] to [ON] in [NETWORK CONTROL] (▶ page 81).
- Do not start up multiple web browsers at the same time to make setting or control. Do not also set or control the projector from multiple computers.
- Change the password first. (▶ page 121)
- Access will be locked for few minutes when an incorrect password is entered three times consecutively.
- Some items on the projector setting page use the Javascript function of the web browser. The projector may not be able to be controlled properly if this function is disabled on the browser settings.
- If the screen for the web control is not displayed, consult your network administrator.
- While updating the screen for the web control, the screen may appear white for a moment, but it is not a malfunction.
- Illustrations of computer screens
 In this manual, descriptions are given in assumption that “Windows 8” OS and the web browser “Internet Explorer 10” are used. The actual size or indications of the screens may differ from that of this manual depending on the OS or web browser you use.

Available functions per account

With the administrator rights, all functions can be used. With the user rights, available functions are restricted. Select an account according to the purpose of use.

Item	Function	Administrator rights*1	User rights*1	Page
[Status]	[Projector status]	✓	✓	107
	Check error information page	✓	✓	108
	[Network status]	✓	✓	109
	[Access error log]	✓	—	109
	[E-mail error log]	✓	—	109
[Projector control]	[Basic control]	✓	✓	110
	[Advanced control]	✓	✓	111
	[Lighting control]	✓	✓	111
[Detailed set up]	[Network config]	✓	—	112
	[Adjust clock]	✓	—	114
	[Ping test]	✓	—	115
	[ECO management set up]	✓	—	115
	[E-mail set up]	✓	—	116
	[Authentication set up]	✓	—	118
	[Port set up]	✓	—	118
[Change password]	User name for [Administrator]	✓	—	121
	User name for [User]	✓	—	122
	Password for [Administrator]	✓	—	121
	Password for [User]	✓	✓	122
[Crestron Connected(TM)]	Operation	✓	—	123
	[Tools]	✓	—	124
	[Info]	✓	—	124
	[Help]	✓	—	125

*1 The functions with ✓ marks in the columns of administrator rights/user rights indicate that the operation can be performed by each right.

Descriptions of items

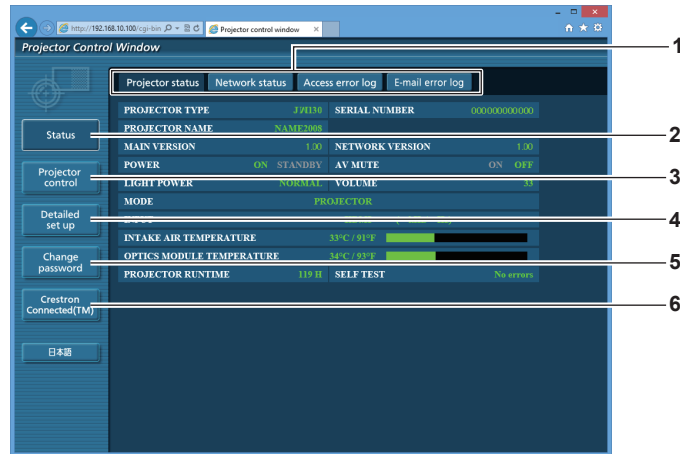

- 1 **Page tab**
Switches pages by clicking this item.
- 2 **[Status]**
The status of the projector is displayed by clicking this item.
- 3 **[Projector control]**
The [Projector control] page is displayed by clicking this item.
- 4 **[Detailed set up]**
The [Detailed set up] page is displayed by clicking this item.
- 5 **[Change password]**
The [Change password] page is displayed by clicking this item.
- 6 **[Crestron Connected(TM)]**
The operation page of Crestron Connected™ is displayed by clicking this item.

[Projector status] page

Click [Status] → [Projector status].

Display the status of the projector for the following items.

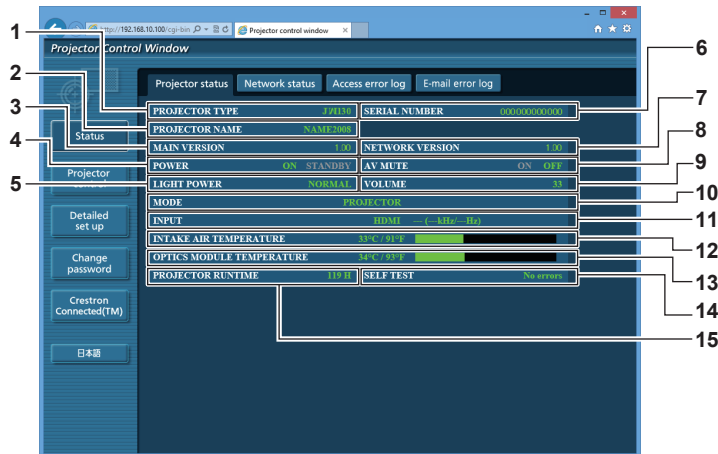

- 1 **[PROJECTOR TYPE]**
Displays the type of the projector.
- 2 **[PROJECTOR NAME]**
Displays the projector name set for the projector.
- 3 **[MAIN VERSION]**
Display the firmware version of the projector.
- 4 **[POWER]**
Displays the status of the power.
- 5 **[LIGHT POWER]**
Displays the setting status of [LIGHT POWER] (➡ page 71).
- 6 **[SERIAL NUMBER]**
Displays the serial number of the projector.
- 7 **[NETWORK VERSION]**
Displays the version of the firmware of the network.
- 8 **[AV MUTE]**
Displays the AV mute status.
- 9 **[VOLUME]**
Displays the volume status.
- 10 **[MODE]**
Displays the current projection mode.
- 11 **[INPUT]**
Displays the current input. It is not displayed when the projection mode is lighting mode. If the input is HDMI, the input signal is also displayed.
- 12 **[INTAKE AIR TEMPERATURE]**
Displays the status of the air intake temperature of the projector.
- 13 **[OPTICS MODULE TEMPERATURE]**
Displays the status of the internal temperature of the projector.
- 14 **[SELF TEST]**
Displays the self-diagnosis information.
- 15 **[PROJECTOR RUNTIME]**
Displays the runtime of the projector.

Error information page

When [Error (Detail)] appears in the self-diagnosis display of the [Projector status] screen, click it to display the error details.

- The projector may go into the standby status to protect the projector depending on the contents of the error.

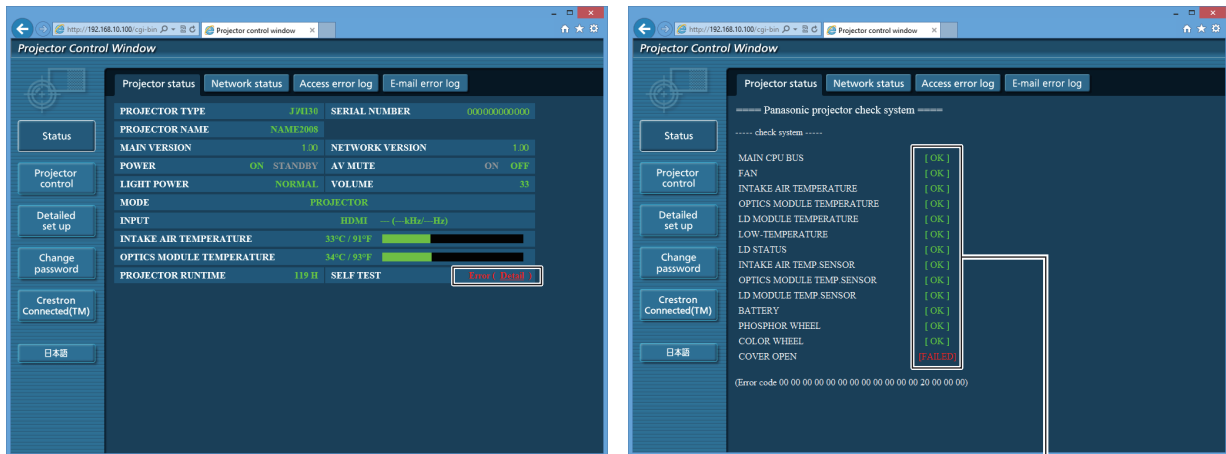

1

1 Self-diagnosis result display

Displays the item check results.

[OK]:

Indicates that operation is normal.

[FAILED]:

Indicates that there is a problem.

■ [FAILED] items

Item	Description
[MAIN CPU BUS]	There is a problem with the microcomputer circuitry. Consult your dealer.
[FAN]	There is a problem with the internal cooling fan or the fan drive circuit. Consult your dealer.
[INTAKE AIR TEMPERATURE]	The intake air temperature is too high. The projector may be used in an environment where the temperature is high, such as near a heating appliance.
[OPTICS MODULE TEMPERATURE]	The temperature around the optics module inside the projector is high. The projector may be used in an environment where the temperature is high, such as near a heating appliance.
[LD MODULE TEMPERATURE]	The temperature of the light source is high. The projector is possibly used in an environment where the temperature is high, such as near a heating appliance.
[LOW-TEMPERATURE]	The internal temperature of the projector or ambient temperature is low. Projection cannot be started until the internal temperature of the projector or ambient temperature becomes warm.
[LD STATUS]	The light source failed to turn on or off. Wait for a while until the light source cools off, and then turn on the power.
[INTAKE AIR TEMP.SENSOR]	There is a problem with the intake temperature detection sensor. Consult your dealer.
[OPTICS MODULE TEMP.SENSOR]	There is a problem with the temperature detection sensor around the optics module inside the projector. Consult your dealer.
[LD MODULE TEMP.SENSOR]	There is a problem with the temperature sensor of the light source. Consult your dealer.
[BATTERY]	Replacement of built-in battery is required. Consult your dealer.
[PHOSPHOR WHEEL]	There is a problem with the phosphor wheel or phosphor wheel drive circuit. Consult your dealer.
[COLOR WHEEL]	There is a problem with the color wheel or color wheel drive circuit. Consult your dealer.
[COVER OPEN]	There is a problem with attachment of the outer case. Consult your dealer.

[Network status] page

Click [Status] → [Network status].
The current network setting status is displayed.



1 **[WIRELESS LAN]**

Displays the settings of wireless LAN.

2 **[WIRED LAN]**

Displays the settings of wired LAN.

[Access error log] page

Click [Status] → [Access error log].
The error log on the web server is displayed such as access to the pages that do not exist or access with unauthorized user names or passwords.

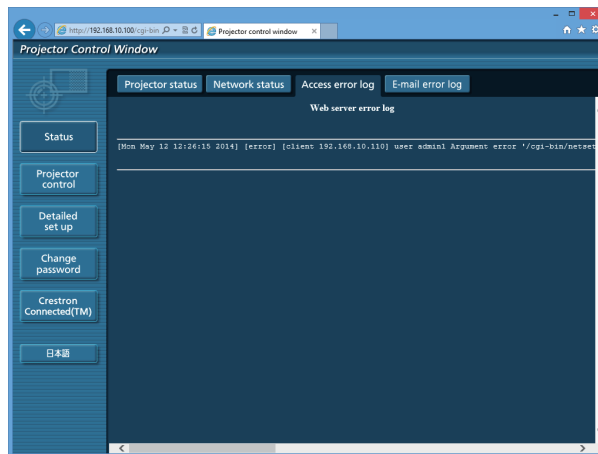

[E-mail error log] page

Click [Status] → [E-mail error log].
E-mail error information is displayed if periodic E-mail sending fails.

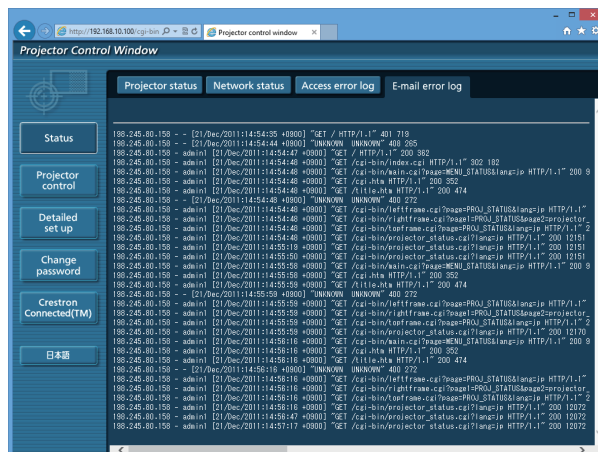

Note

- [Access error log]/[E-mail error log] displays the recent several hundreds of accesses/requests. All information may not be displayed when many accesses/requests are made at a time.
- When information in [Access error log]/[E-mail error log] exceeds a certain amount, they are erased from the oldest.
- Check [Access error log]/[E-mail error log] periodically.

[Basic control] page

Click [Projector control] → [Basic control].

For projector mode

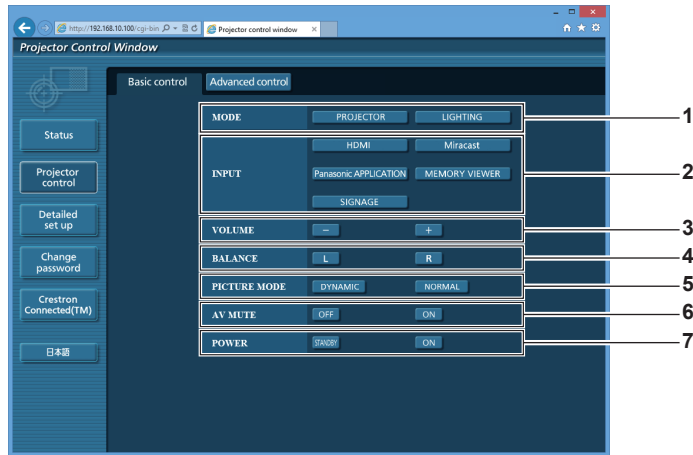

For lighting mode

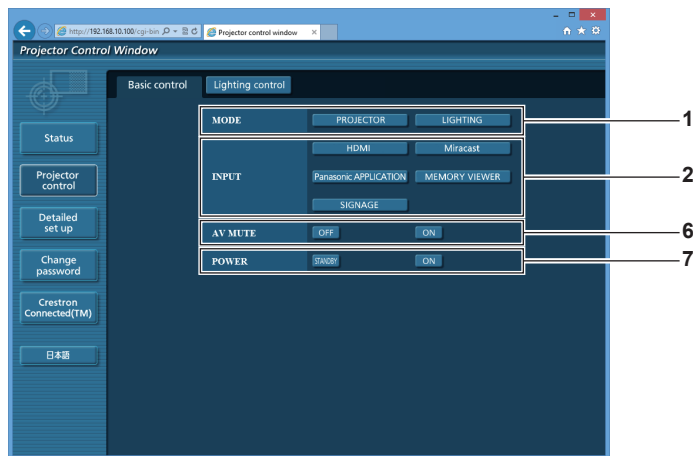

- | | |
|---|---|
| <p>1 [MODE]
Switches the projection mode.</p> <p>2 [INPUT]
Switches the input.</p> <p>3 [VOLUME]
Adjusts the volume.</p> <p>4 [BALANCE]
Adjusts the right/left audio balance.</p> | <p>5 [PICTURE MODE]
Switches the picture mode.</p> <p>6 [AV MUTE]
Switches AV mute on/off.</p> <p>7 [POWER]
Switches on/off the power.</p> |
|---|---|

Attention

- When you turn on the projector, be careful so that the eyes of people around the projector are not exposed to the sudden light from the light source.
Or operate the projector only if the eyes of people around the projector are not exposed to the light from the light source even when projection starts suddenly.

Note

- When the [NETWORK] menu → [WIRELESS LAN] (➡ page 78) is set to [M-DIRECT] or [S-DIRECT] and web control is performed via wireless LAN, switching to Miracast disconnects the wireless LAN and disables later web control operations.
- When the [NETWORK] menu → [WIRELESS LAN] (➡ page 78) is set to [M-DIRECT] or [S-DIRECT] and web control is performed via wireless LAN, turning on the power and starting projection with Miracast input disconnects the wireless LAN and disables later web control operations.

- When the [SETUP] menu → [STARTUP INPUT SELECT] (⇒ page 73) is set to [LAST USED]
Turn off the power when the input other than Miracast is selected or when the projector is in the lighting mode.
If the projector is in standby mode with Miracast input, switch the input to other than Miracast in the [Basic control] page before turning on the power.
- When the [SETUP] menu → [STARTUP INPUT SELECT] (⇒ page 73) is set to [Miracast]
Switch the input to other than Miracast using the remote control after projection has been started or set [STARTUP INPUT SELECT] to other than [Miracast] beforehand.

[Advanced control] page

Click [Projector control] → [Advanced control].

If the projection mode is set to lighting mode, switch to the projector mode in the [Basic control] page and click [Projector control] → [Advanced control].

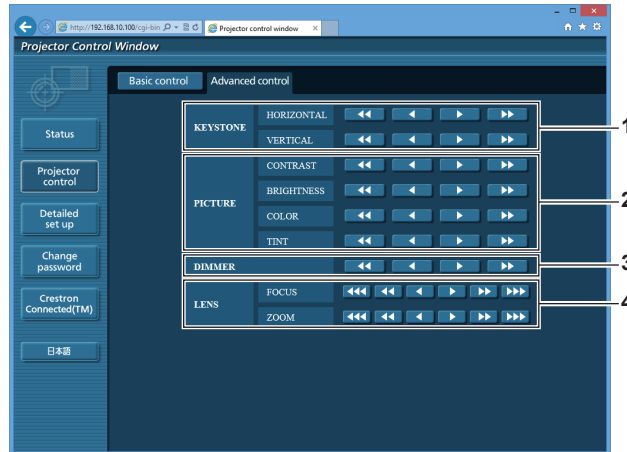

- | | |
|--|---|
| <p>1 [KEYSTONE]
Corrects horizontal/vertical keystone distortion.</p> <p>2 [PICTURE]
Switches the input.</p> | <p>3 [DIMMER]
Adjusts the brightness.</p> <p>4 [LENS]
Adjusts the projection lens (focus/zoom).</p> |
|--|---|

[Lighting control] page

Click [Projector control] → [Lighting control].

If the projection mode is projector mode, switch to the lighting mode in the [Basic control] page and click [Projector control] → [Lighting control].

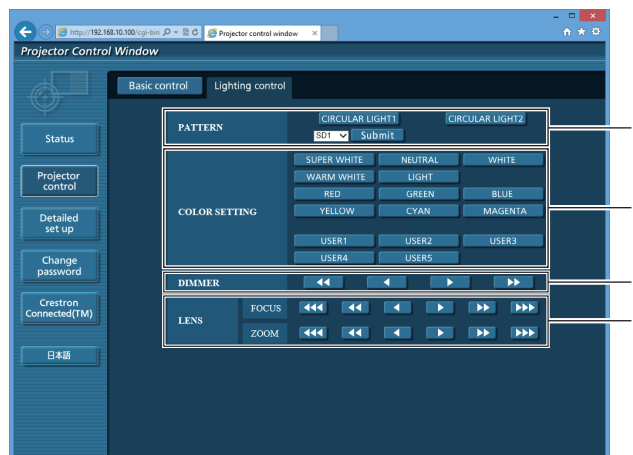

- | | |
|---|---|
| <p>1 [PATTERN]
Switches the lighting pattern.</p> <p>2 [COLOR SETTING]
Switches the color for lighting.</p> | <p>3 [DIMMER]
Adjusts the brightness.</p> <p>4 [LENS]
Adjusts the projection lens (focus/zoom).</p> |
|---|---|

Setting desired color

On the [Lighting control] page, click [USER1] to [USER5] in [COLOR SETTING].

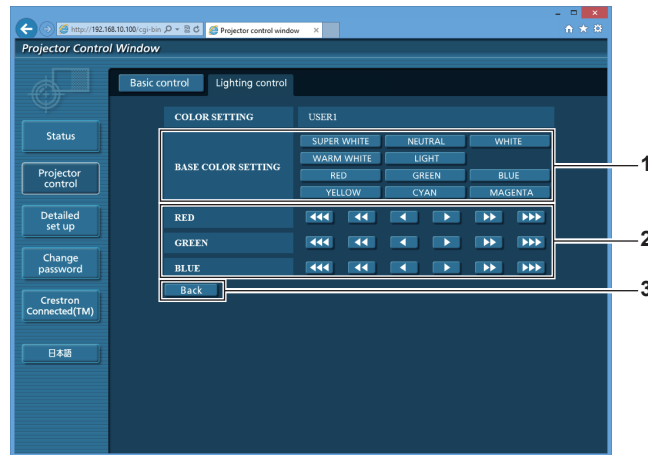

- 1 **[BASE COLOR SETTING]**
Switches the setting of the base color.
- 2 **[RED], [GREEN], [BLUE]**
Adjusts the color based on the color selected in [BASE COLOR SETTING].
- 3 **[Back] button**
Returns to the previous screen.

Note

- For details of settings, refer to “Setting a desired color” (➔ page 60) which explains the [LIGHTING] menu → [COLOR SETTING] of the projector.

[Network config] page

Click [Detailed set up] → [Network config].

- 1) **Click [Network config].**
 - The **[CAUTION!]** screen is displayed.

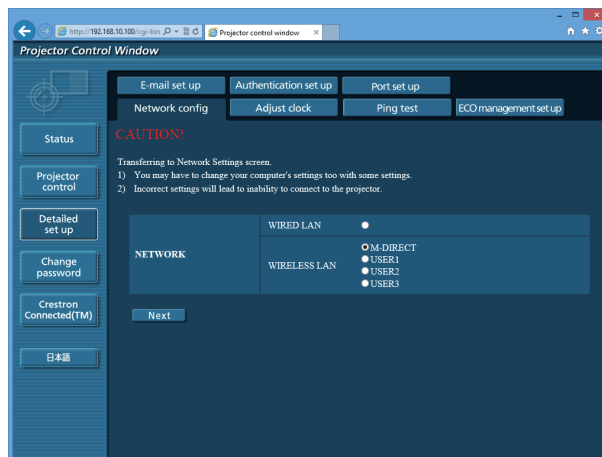

- 2) **Select an item for which you want to change the setting, and click the [Next] button.**
 - The current settings are displayed.
- 3) **Click the [Change] button.**
 - The setting change screen is displayed.

Connecting with wired LAN

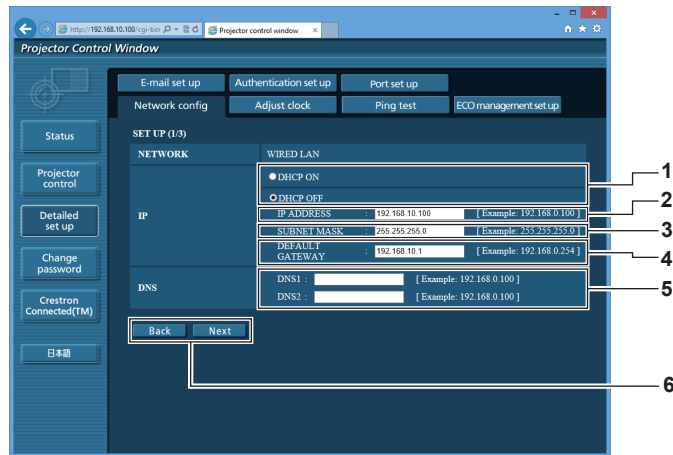

- | | |
|--|---|
| <p>1 [DHCP ON], [DHCP OFF]
To enable the DHCP client function, set [DHCP ON].</p> <p>2 [IP ADDRESS]
Enter the IP address when not using a DHCP server.</p> <p>3 [SUBNET MASK]
Enter the subnet mask when not using a DHCP server.</p> <p>4 [DEFAULT GATEWAY]
Enter the default gateway address when not using a DHCP server.</p> | <p>5 [DNS1], [DNS2]
Enter the primary DNS/secondary DNS server address when you do not use a DHCP server.
Available characters: Numbers (0 - 9), period (.)
(Example: 192.168.0.253)</p> <p>6 [Back] button, [Next] button
Click the [Back] button to return to the previous screen. Click the [Next] button to display a screen to confirm the settings. Click the [Submit] button to update the settings.</p> |
|--|---|

Note

- When you use the “Forward” or “Back” functions of your browser, a warning message “Page has Expired” may appear. In that case, click [Network config] again as the subsequent operations will not be guaranteed.
- Changing LAN settings while connected to the LAN may cause the connection to cut out.

Connecting with wireless LAN (M-DIRECT)

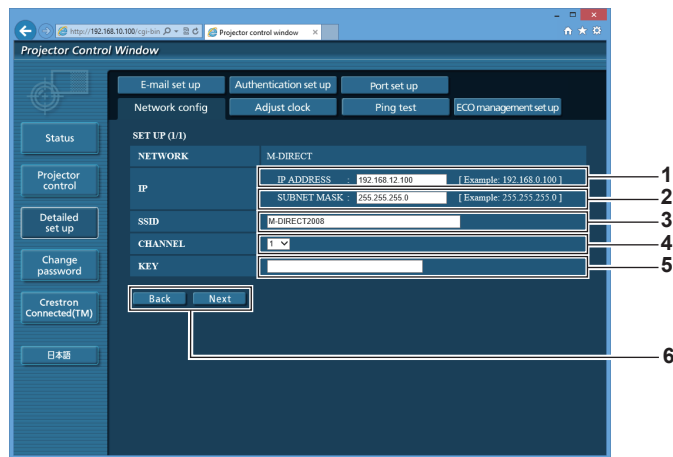

- | | |
|---|--|
| <p>1 [IP ADDRESS]
Enter the IP address.</p> <p>2 [SUBNET MASK]
Enter the subnet mask.</p> <p>3 [SSID]
Set SSID to be used with M-DIRECT.</p> <p>4 [CHANNEL]
Set the channel to be used with M-DIRECT.</p> | <p>5 [KEY]
Set the key to be used with M-DIRECT.
Enter 8 to 63 alphanumeric characters or 64-digit hexadecimal.</p> <p>6 [Back] button, [Next] button
Click the [Back] button to return to the previous screen. Click the [Next] button to display a screen to confirm the settings. Click the [Submit] button to update the settings.</p> |
|---|--|

Connecting with wireless LAN (USER1 to USER3)

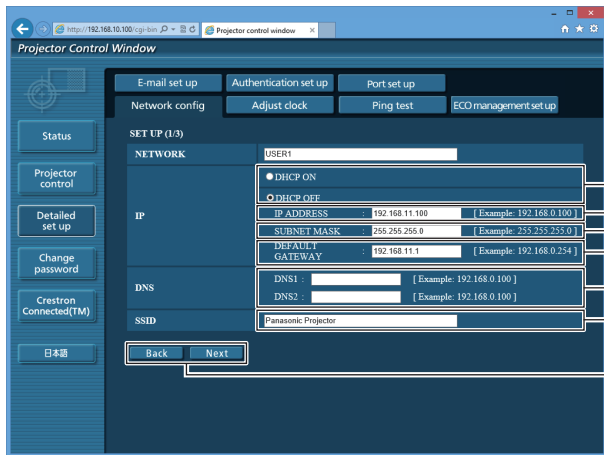

- 1 **[DHCP ON], [DHCP OFF]**
To enable the DHCP client function, set [DHCP ON].
- 2 **[IP ADDRESS]**
Enter the IP address when you do not use a DHCP server.
- 3 **[SUBNET MASK]**
Enter the subnet mask when you do not use a DHCP server.
- 4 **[DEFAULT GATEWAY]**
Enter the default gateway address when you do not use a DHCP server.
- 5 **[DNS1], [DNS2]**
Enter the primary DNS/secondary DNS server address when you do not use a DHCP server.
- 6 **[SSID]**
Enter the same string as the SSID registered to the access point.
- 7 **[Back] button, [Next] button**
Click the [Back] button to return to the previous screen. Click the [Next] button to display a screen to confirm the settings. Click the [Submit] button to update the settings.
- 8 **[AUTHENTICATION]**
Select the user authentication method used in the network to which the projector is connected.
- 9 **[EAP]**
Select the EAP set for RADIUS server.
- 10 **[ENCRYPTION]**
Select the encryption method used for the communication between the projector and the network.

Note

- The contents in the setting screen differ depending on the authentication method of the connected wireless LAN.

[Adjust clock] page

Click [Detailed set up] → [Adjust clock].

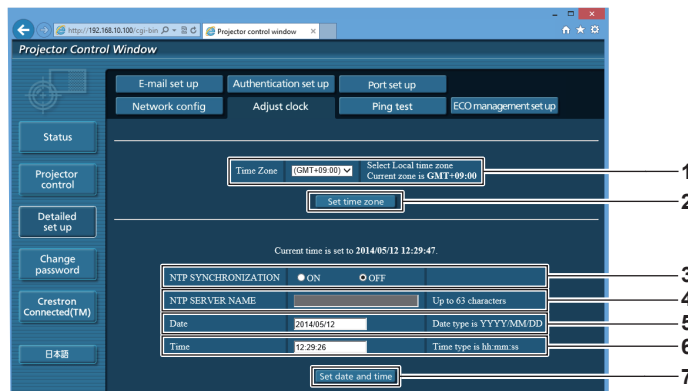

- 1 **[Time Zone]**
Select the time zone.
- 2 **[Set time zone]**
Updates the time zone setting.
- 3 **[NTP SYNCHRONIZATION]**
To synchronize with the NTP server and adjust the date and time of the projector automatically, set it to [ON].
- 4 **[NTP SERVER NAME]**
Enter the IP address or server name of the NTP server when synchronizing with the NTP server. (To enter the server name, the DNS server needs to be set up.)
- 5 **[Date]**
Enter the date to be changed.
- 6 **[Time]**
Enter the time to be changed.
- 7 **[Set date and time] button**
Updates the date and time settings.

Note

- The battery inside the projector needs to be replaced if the time is reset when the power is turned on. Consult your dealer.

[Ping test] page

Check whether the network is connected to the E-mail server, POP server, DNS server, etc.
Click [Detailed set up] → [Ping test].

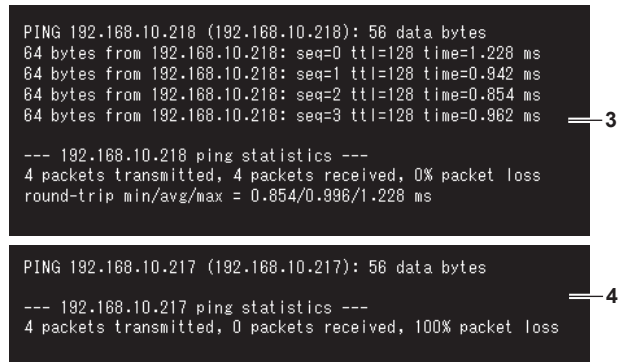
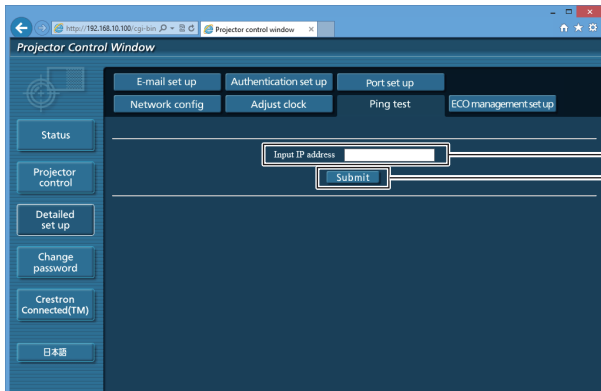

- 1 **[Input IP address]**
Enter the IP address of the server to be tested.
- 2 **[Submit] button**
Executes the connection test.
- 3 **Example of display when the connection has succeeded**
- 4 **Example of display when the connection has failed**

[ECO management set up] page

Settings related to the ECO management function of the projector can be made.
Click [Detailed set up] → [ECO management set up].

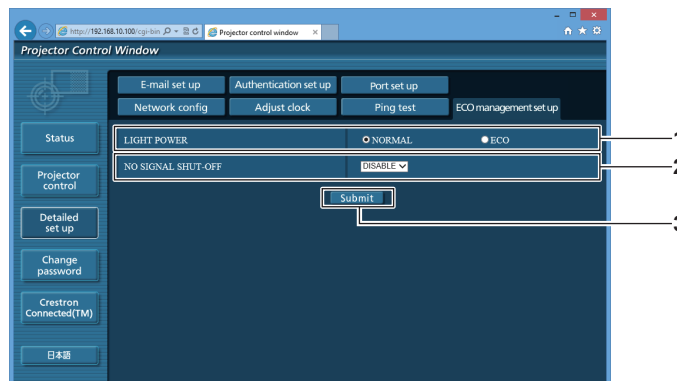

- 1 **[LIGHT POWER]**
Select the light source power setting.
- 2 **[NO SIGNAL SHUT-OFF]**
When [NO SIGNAL SHUT-OFF] is used, select the time until the projector goes into the standby status.
- 3 **[Submit] button**
Updates the settings.

Note

- For details of each setting item, refer to the [SETUP] menu → [ECO MANAGEMENT] (▶ page 71) of the projector.

[E-mail set up] page

When a problem occurs, an E-mail can be sent to the E-mail addresses (up to two) that have been set beforehand.

Click [Detailed set up] → [E-mail set up].

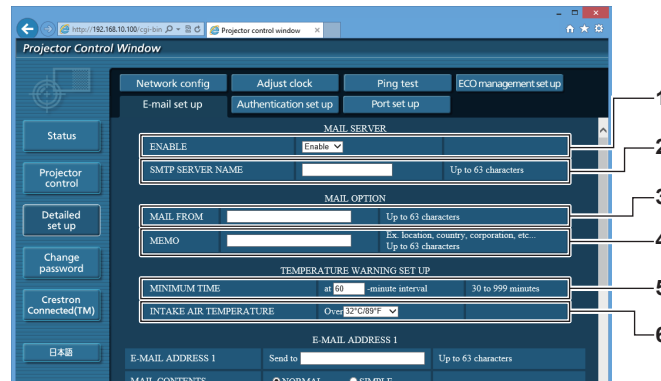

- 1 **[ENABLE]**
Select [Enable] to use the E-mail function.
- 2 **[SMTP SERVER NAME]**
Enter the IP address or the server name of the E-mail server (SMTP). To enter the server name, the DNS server needs to be set up.
- 3 **[MAIL FROM]**
Enter the E-mail address of the projector. (Up to 63 characters in single byte)
- 4 **[MEMO]**
Enter information such as the location of the projector that notifies the sender of the E-mail. (Up to 63 characters in single byte)
- 5 **[MINIMUM TIME]**
Change the minimum interval for the temperature warning E-mail. The default value is 60 minutes. In this case, another E-mail will not be sent for 60 minutes after sending the temperature warning E-mail even if it reaches the warning temperature.
- 6 **[INTAKE AIR TEMPERATURE]**
Change the temperature setting for the temperature warning mail. A temperature warning E-mail is sent when the temperature exceeds this value.

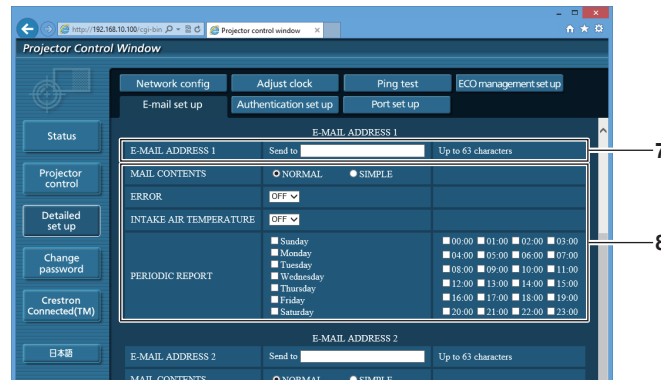

- 7 **[E-MAIL ADDRESS 1]**
Enter the E-mail address to send E-mails.
- 8 **Settings of the conditions to send E-mail**
Select the conditions to send E-mail.
[MAIL CONTENTS]:
Select either [NORMAL] or [SIMPLE].
[ERROR]:
Sends an E-mail when an error occurred in the self-diagnosis.
[INTAKE AIR TEMPERATURE]:
Sends an E-mail when the air intake temperature has reached the value set at the above field.
[PERIODIC REPORT]:
Place a check mark on this to send an E-mail periodically. E-mails will be sent on the days of week and time with the check marks.

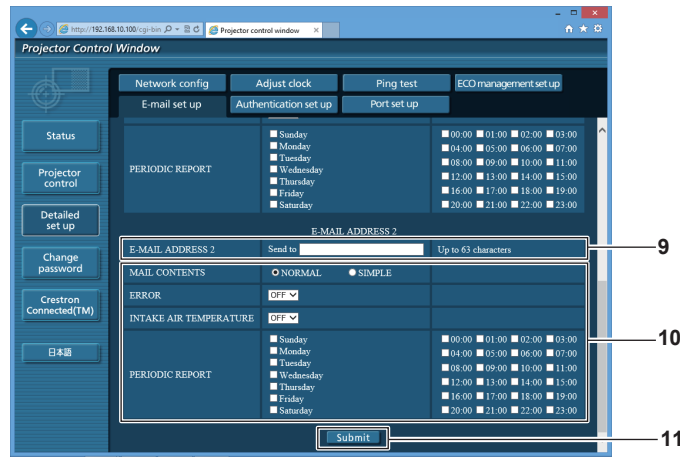

9 [E-MAIL ADDRESS 2]

If you use the second E-mail address, enter the E-mail address to send E-mails.
Leave it blank when you do not use the second E-mail address.

10 Settings of the conditions to send E-mail

Select the conditions to send E-mails to the second E-mail address.

[MAIL CONTENTS]:

Select either [NORMAL] or [SIMPLE].

[ERROR]:

Sends an E-mail when an error occurred in the self-diagnosis.

[INTAKE AIR TEMPERATURE]:

Sends an E-mail when the air intake temperature has reached the value set at the above field.

[PERIODIC REPORT]:

Place a check mark on this to send an E-mail periodically to the second E-mail address.

E-mails will be sent at the days of week and time with the check marks.

11 [Submit] button

Updates the settings.

[Authentication set up] page

Set the authentication items when POP authentication or SMTP authentication is necessary to send an E-mail. Click [Detailed set up] → [Authentication set up].

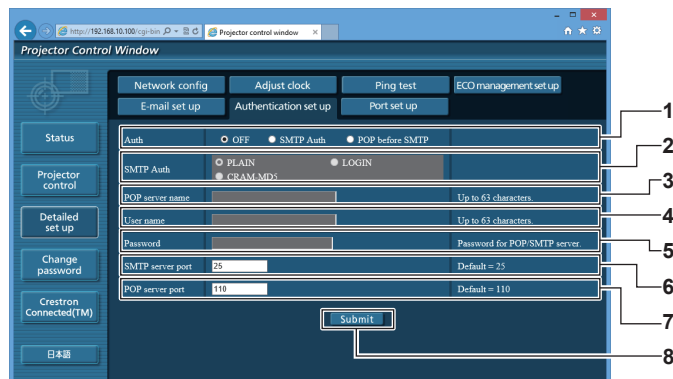

- 1 **[Auth]**
Select the authentication method specified by your Internet service provider.
- 2 **[SMTP Auth]**
Set when the SMTP authentication is selected.
- 3 **[POP server name]**
Enter the POP server name.
Allowed characters:
Alphanumerics (A - Z, a - z, 0 - 9)
Minus sign (-) and period (.)
- 4 **[User name]**
Enter the user name for the POP server or the SMTP server.
- 5 **[Password]**
Enter the password for the POP server or the SMTP server.
- 6 **[SMTP server port]**
Enter the port number of the SMTP server.
(Normally 25)
- 7 **[POP server port]**
Enter the port number of the POP server.
(Normally 110)
- 8 **[Submit] button**
Update the settings.

[Port set up] page

Set the port number used for command control. Click [Detailed set up] → [Port set up].

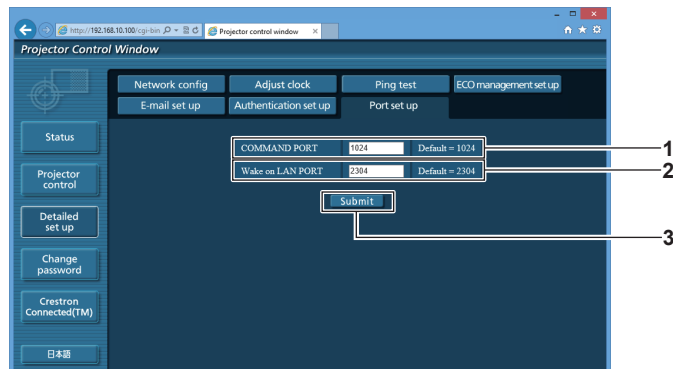

- 1 **[COMMAND PORT]**
Enter the port number used for command control.
- 2 **[Wake on LAN PORT]**
When the [STANDBY MODE] menu is set to [NETWORK], enter the port number used for the Wake on LAN function.
- 3 **[Submit] button**
Updates the settings.

Contents of E-mail sent

Example of the E-mail sent when E-mail is set

The following E-mail is sent when the E-mail settings have been established.

```

=== Panasonic projector report(CONFIGURE) ===
Projector Type      : JW130F
Serial No          : DA1234567

---- E-mail setup data----
TEMPERATURE WARNING SETUP
MINIMUM TIME      at [ 60] minutes interval
INTAKE AIR TEMPERATURE Over [ 32 degC / 89 degF ]

ERROR              [ ON ]
INTAKE AIR TEMPERATURE [ OFF ]
PERIODIC REPORT
Sunday [ ON ]   Monday [ ON ]   Tuesday [ ON ]   Wednesday [ ON ]
Thursday [ ON ] Friday [ ON ]   Saturday [ ON ]

00:00 [ ON ]   01:00 [ ON ]   02:00 [ ON ]   03:00 [ ON ]
04:00 [ ON ]   05:00 [ ON ]   06:00 [ ON ]   07:00 [ ON ]
08:00 [ ON ]   09:00 [ ON ]   10:00 [ ON ]   11:00 [ ON ]
12:00 [ ON ]   13:00 [ ON ]   14:00 [ ON ]   15:00 [ ON ]
16:00 [ ON ]   17:00 [ ON ]   18:00 [ ON ]   19:00 [ ON ]
20:00 [ ON ]   21:00 [ ON ]   22:00 [ ON ]   23:00 [ ON ]

---- check system ----
MAIN CPU BUS [ OK ]
FAN [ OK ]
INTAKE AIR TEMPERATURE [ OK ]
OPTICS MODULE TEMPERATURE [ OK ]
LD MODULE TEMPERATURE [ OK ]
LOW-TEMPERATURE [ OK ]
LD STATUS [ OK ]
INTAKE AIR TEMP.SENSOR [ OK ]
OPTICS MODULE TEMP.SENSOR [ OK ]
LD MODULE TEMP.SENSOR [ OK ]
BATTERY [ OK ]
PHOSPHOR WHEEL [ OK ]
COLOR WHEEL [ OK ]
COVER OPEN [ OK ]
(Error code 00 00 00 00 00 00 00 00 00 00 00 00 01 00 00 00)

Intake air temperature :158 degC / 316 degF
Optics module temperature : 28 degC / 82 degF
PROJECTOR RUNTIME      30 H

----- Current status -----
MAIN VERSION          1.00
NETWORK VERSION       1.00
SUB VERSION           1.00
POWER STATUS          POWER=ON
INPUT                 HDMI
SIGNAL NAME           ---
SIGNAL FREQUENCY      --kHz / ---Hz

---- Wired Network configuration ----
DHCP Client           OFF
IP address            192.168.10.100
MAC address           00:16:E8:6A:42:7E

---- Wireless Network configuration ----
DHCP Client           OFF
IP address            192.168.12.100
MAC address           C0:D9:62:F5:46:5B

Mon Jan 01 12:34:56 20XX

---- Memo ----

```

Example of the E-mail sent for an error

The following E-mail is sent when an error has occurred.

```
=== Panasonic projector report(CONFIGURE) ===
Projector Type : JW130F
Serial No      : DA1234567

----- check system -----
MAIN CPU BUS           [ OK ]
FAN                    [ OK ]
INTAKE AIR TEMPERATURE [ OK ]
OPTICS MODULE TEMPERATURE [ OK ]
LD MODULE TEMPERATURE [ OK ]
LOW-TEMPERATURE        [ FAILED ]
LD STATUS               [ FAILED ]
INTAKE AIR TEMP.SENSOR [ OK ]
OPTICS MODULE TEMP.SENSOR [ OK ]
LD MODULE TEMP.SENSOR [ OK ]
BATTERY                 [ OK ]
PHOSPHOR WHEEL         [ OK ]
COLOR WHEEL            [ OK ]
COVER OPEN             [ OK ]
(Error code 00 00 00 00 00 00 00 00 00 00 00 01 00 00 89)

Intake air temperature :158 degC / 316 degF
Optics module temperature : 28 degC / 82 degF
PROJECTOR RUNTIME      30 H

----- Current status -----
MAIN VERSION          1.00
NETWORK VERSION       1.00
SUB VERSION           1.00
POWER STATUS          POWER=ON
INPUT                 HDMI
SIGNAL NAME           ---
SIGNAL FREQUENCY      ---kHz / ---H

----- Wired Network configuration -----
DHCP Client           OFF
IP address            192.168.10.100
MAC address           00:16:E8:6A:42:7E

----- Wireless Network configuration -----
DHCP Client           OFF
IP address            192.168.12.100
MAC address           C0:D9:62:F5:46:5B

Mon Jan 01 12:34:56 20XX

----- Memo -----
```

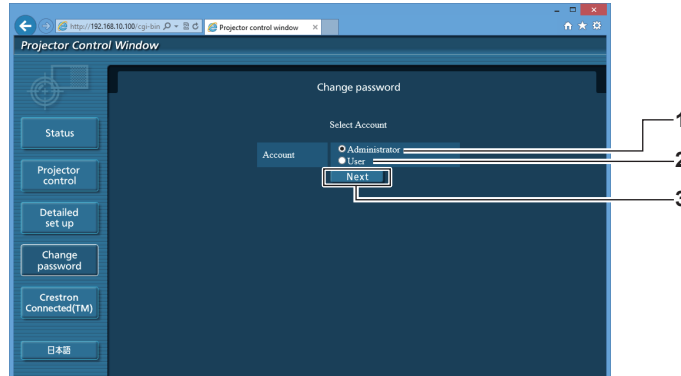

[Change password] page

Click [Change password].

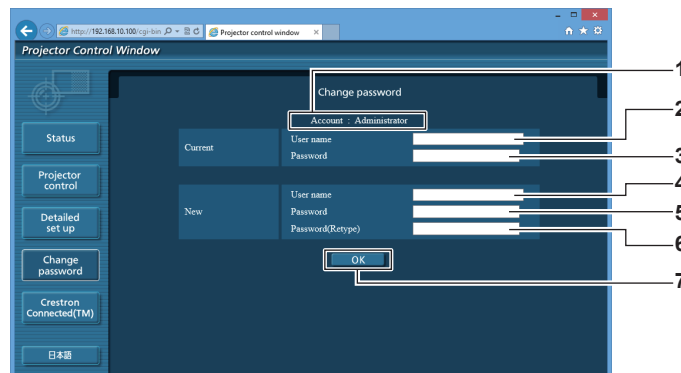

- | | |
|---|---|
| <p>1 [Administrator]
Used to change the setting of the [Administrator].</p> <p>2 [User]
Used to change the setting of the [User].</p> | <p>3 [Next] button
Used to change the setting of the password.</p> |
|---|---|

[Administrator] account



- | | |
|--|---|
| <p>1 [Account]
Displays the account to change.</p> <p>2 [Current][User name]
Enter the user name before the change.</p> <p>3 [Current][Password]
Enter the current password.</p> <p>4 [New][User name]
Enter the desired new user name. (Up to 16 characters in single byte)</p> | <p>5 [New][Password]
Enter the desired new password. (Up to 16 characters in single byte)</p> <p>6 [New][Password(Retype)]
Enter the desired new password again.</p> <p>7 [OK] button
Determines the change of password.</p> |
|--|---|

[User] account

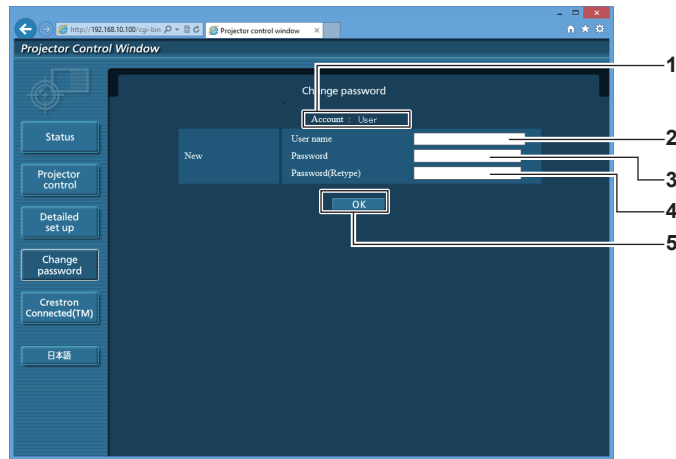

- | | |
|--|--|
| <p>1 [Account]
Displays the account to change.</p> <p>2 [New][User name]
Enter the desired new user name. (Up to 16 characters in single byte)</p> | <p>3 [New][Password]
Enter the desired new password. (Up to 16 characters in single byte)</p> <p>4 [New][Password(Retyp)]
Enter the desired new password again.</p> <p>5 [OK] button
Determines the change of password.</p> |
|--|--|

[Change password] (For user rights)

Only the change of password is enabled under the user rights.

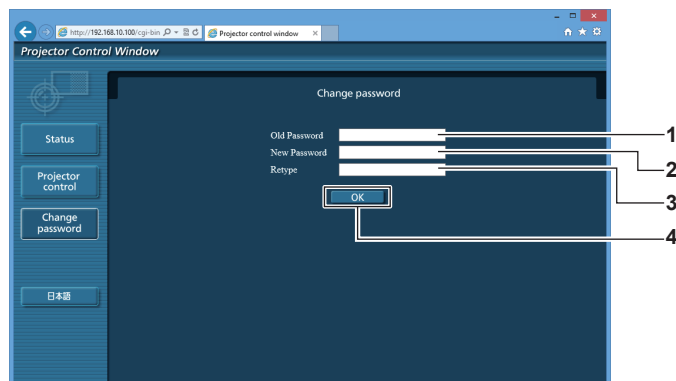

- | | |
|--|---|
| <p>1 [Old Password]
Enter the current password.</p> <p>2 [New Password]
Enter the desired new password. (Up to 16 characters in single byte)</p> | <p>3 [Retype]
Enter the desired new password again.</p> <p>4 [OK] button
Determines the change of password.</p> |
|--|---|

Note

- To change the account of the administrator, you must enter the [User name] and [Password] in [Current].

[Crestron Connected(TM)] page

The projector can be monitored/controlled with Crestron Connected™.

To start the Crestron Connected™ operation page from the web control screen, you need to access with the administrator rights. (For user rights, the [Crestron Connected(TM)] button is not displayed on the web control screen.)

The operation page of Crestron Connected™ is displayed by clicking [Crestron Connected(TM)].

It is not displayed if Adobe® Flash® Player is not installed on your computer or your web browser does not support Flash. In that case, click [Back] on the operation page to go back to the previous page.

Operation page

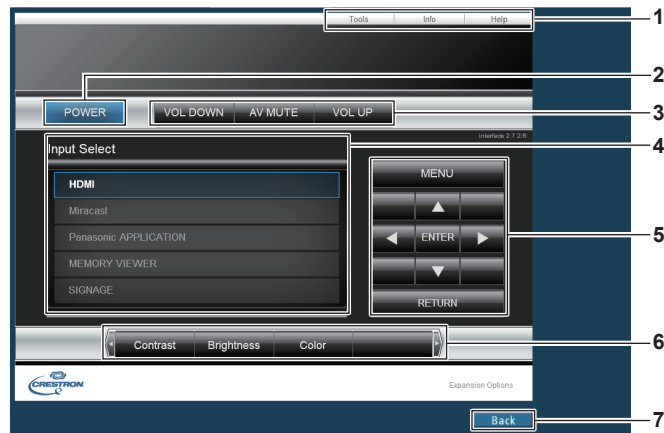

- 1 **[Tools]/[Info]/[Help] tab**
Tabs for switching the setting, information, or help page of the projector.
- 2 **[POWER] button**
Switches off/on the power.
- 3 **[VOL DOWN]/[AV MUTE]/[VOL UP] button**
Operates the volume/AV mute. These operations are not available when the projector is turned off.

- 4 **[Input Select] button**
Controls input selection.
The operation is not available when the projector is turned off.
- 5 **Menu screen control buttons**
Operates the menu screen.
- 6 **Image quality adjustment button**
Operates image quality settings.
- 7 **[Back] button**
Goes back to the previous page.

Attention

- When you turn on the projector, be careful so that the eyes of people around the projector are not exposed to the sudden light from the light source.
Or operate the projector only if the eyes of people around the projector are not exposed to the light from the light source even when projection starts suddenly.

[Tools] page

Click the [Tools] tab on the operation page.

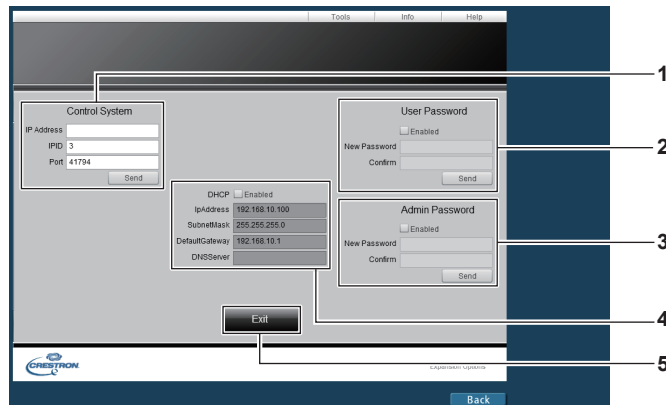

- | | |
|--|---|
| <p>1 [Control System]
Sets the information required for communicating with the controller to be connected with the projector.</p> <p>2 [User Password]
Sets the user rights password for the Crestron Connected™ operation page.</p> <p>3 [Admin Password]
Sets the administrator rights password for the Crestron Connected™ operation page.</p> | <p>4 Network status
Displays the settings of wired LAN.
[DHCP]
Displays the current setting value.
[IpAddress]
Displays the current setting value.
[SubnetMask]
Displays the current setting value.
[DefaultGateway]
Displays the current setting value.
[DNSServer]
Displays the current setting value.</p> <p>5 [Exit] button
Returns to the operation page.</p> |
|--|---|

[Info] page

Click the [Info] tab on the operation page.

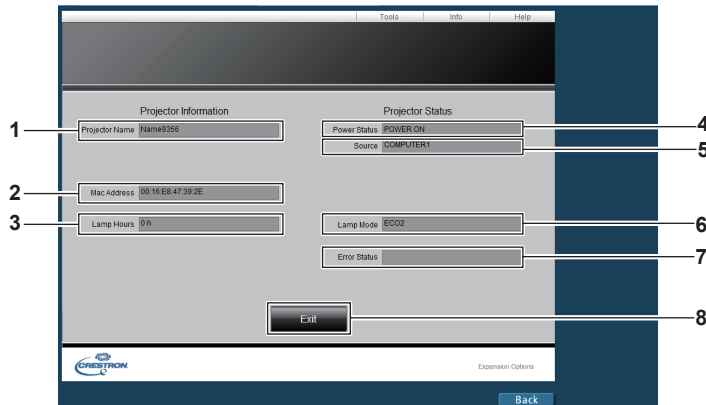

- | | |
|--|--|
| <p>1 [Projector Name]
Displays the projector name.</p> <p>2 [Mac Address]
Displays the MAC address.</p> <p>3 [Lamp Hours]
Displays the runtime of the projector.</p> <p>4 [Power Status]
Displays the status of the power.</p> | <p>5 [Source]
Displays the selected image input.</p> <p>6 [Lamp Mode]
Displays the light source mode.</p> <p>7 [Error Status]
Displays the error status.</p> <p>8 [Exit] button
Returns to the operation page.</p> |
|--|--|

[Help] page

Click the [Help] tab on the operation page.

The [Help Desk] window is displayed.

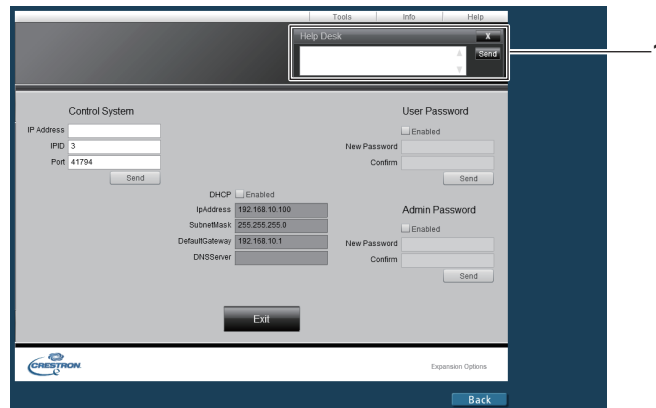

- 1 **[Help Desk]**
Sends/receives messages to/from an administrator who uses Crestron Connected™.

Miracast function

This function connects a terminal compatible with Miracast to the projector via wireless LAN to display the terminal screen with the projector.

Connecting a Miracast compatible terminal

- 1) **Press the <Miracast> button.**
 - The input changes to Miracast, and the Miracast standby screen is displayed.
- 2) **Start the Miracast application on the Miracast compatible terminal.**
 - Check the projector name/network ID/MAC address of wireless LAN displayed on the Miracast standby screen, and then select the relevant device name on the Miracast application.
- 3) **Press ◀▶ to select [OK] on the connection terminal authentication screen displayed on the projection screen, and then press the <ENTER> button.**
 - The screen of the connected terminal is displayed.

Note

- The name and startup method of the Miracast application varies depending on the model.
- For the operation of Miracast application, refer to the operating instructions of your terminal.
- The default projector name is "NAMExxxx", and the network ID is "Projxxxx" (xxxx is a four digit number and differs depending on the product). You can check the projector name/network ID/MAC address of wireless LAN from the [NETWORK] menu → [NETWORK STATUS] (➡ page 83).

Terminating connection with the Miracast compatible terminal

Terminate connection from the Miracast application on the terminal. When disconnected, the Miracast standby screen is displayed.

If you terminate the connection forcibly such as turning off the terminal power without going through the disconnection process, it may take some time before the Miracast standby screen is displayed.

Note

- Miracast is a system standardized by Wi-Fi Alliance, and is capable of displaying copyright protected content (such as HDCP DVDs).
- When the [WIRELESS LAN] (➡ page 78) menu is set to [DISABLE], the Miracast function is also disabled.
- When a space is used in [PROJECTOR NAME], characters after the space may not appear depending on the model of the Miracast compatible terminal.

Content Manager

Content Manager has the following functions.

- **Signage playback function**

- Plays still image/movie/music files in the SD card, changes brightness of the light source, and turns off/on the power according to the registered schedule.
- Plays still image/movie files in the SD card according to the slideshow setting.

- **Signage setting function**

- Sets a schedule.
- Sets a slideshow.

Definitions of main terms used in this section (“Content Manager”) are as follows.

Term	Description
Content	Indicates the materials registered in the Content Manager. There are four playback contents of still image/movie/external input/music and two projector control contents of brightness/power supply. Contents of still image/movie/music are registered in the Content Manager using still image/movie/music files.
Image content	Indicates the corrective term of three playback contents of still image/movie/external input.
External input content	Indicates the content of the signal input to HDMI of the projector, registered in the Content Manager as a material.
Brightness content	Indicates the material to change the brightness of the projector’s light source.
Power supply content	Indicates the material to perform power on/off operation of the projector.
Playlist	Indicates the multiple contents of still image/movie/external registered in the Content Manager as a single material.
Timetable	Indicates the settings of playback contents, playback time, playback order, etc. in a day.

Files compatible with signage playback

The signage playback function (schedule/slideshow) can use the following still image/movie/music files.

	Extension	Format	Restriction
Still image	jpg/jpeg	JPEG	Number of pixels: Maximum 8 000 x 8 000 (For progressive JPEG, maximum 4 096 x 4 096) YUV format: Only YUV444, YUV422, and YUV411 supported Color mode: Only RGB supported
	bmp	Windows Bitmap	Number of pixels: Maximum 2 000 x 2 000 (1-bit, 4-bit, 8-bit, 16-bit, 24-bit, and 32-bit supported) Following formats are not supported. Run-length encoding, Bit fields, Top to bottom, Transparent data

	Extension	Codec		Restriction*2	
		Video	Audio	Video	Audio
Movie*1	mov	H.264/MPEG-4 AVC Motion JPEG	AAC Linear PCM	Resolution: Maximum 1 920 x 1 080 Minimum 240 x 180 Frame rate: Maximum 30 fps Bit rate: Maximum 40 Mbps	Sample rate: Maximum 48 kHz (For Linear PCM, maximum 16 kHz) Channel: Maximum 2 ch Bit rate: Maximum 384 kbps
	avi	H.264/MPEG-4 AVC Motion JPEG MPEG-4	MPEG-1/2 Audio Layer-3 (MP3) AAC Linear PCM		
	mp4	H.264/MPEG-4 AVC MPEG-4	AAC MPEG-4 AAC-LC		
	mpg/mpeg	MPEG-2	MPEG-1/2 Audio Layer-2		
	wmv	WMV9	WMA		

*1 To play back a schedule simultaneously in multiple projectors, use the following movie file as a movie content. If you use the movie files other than the following, simultaneous playback function may not work properly.

For details on simultaneous playback, refer to “Playing back the schedule simultaneously in multiple projectors” (➔ page 182).

- Extension: mp4, Video codec: H.264/MPEG-4 AVC, Audio codec: AAC
- Extension: mpg/mpeg, Video codec: MPEG-2, Audio codec: MPEG-1/2 Audio Layer-2

*2 Following movie files are not supported.

- Files with the video codec of WMV7, WMV8, DivX, or Xvid
- Uncompressed video
- Multi-angle video
- Files with the profile of Advanced Simple Profile @ Level 0 or Advanced Simple Profile @ Level 1

Music	Extension	Audio codec	Audio format
	aac	AAC	Sample rate: Maximum 48 kHz Channel: Maximum 2 ch Bit rate: Maximum 384 kbps
	mp3	MPEG-1/2 Audio Layer-3 (MP3)	
	wma	WMA	

Note

- Some information for still image/movie/music files can be viewed with a computer where relevant files are accessible.

Operation example

- For Windows computer

- Right-click a file, and click [Properties].
- Click the [Details] tab.

- For Mac

- Click a file while holding down the “Control” key, and click [Get Info].
- Click [More Info].

- The maximum file size that can be used is 2 GB.

The following table shows the playback time when a 2 GB movie file is used. However, the following playback time is an estimate and may differ depending on the compression method such as encoding and codec.

Resolution	Bit rate	Estimate of playback time
720 x 240	Approx. 2 Mbps	Approx. 120 minutes
720 x 480	Approx. 5 Mbps	Approx. 50 minutes

- Files protected by DRM (Digital Rights Management) cannot be used.
- Some files listed as compatible formats may still not be able to be used.
- Use the SD card with high data transfer speed. If the data transfer speed is slow, movie or music recorded in the SD card may not be played back properly or it may take time to display a still image. (Speed class: Class 10 recommended)
- For SD cards compatible with the projector, refer to “Cards that can be used with the projector” (➔ page 49).

Computers for the signage setting

The signage setting is performed by connecting a client computer (including iPad/iPhone/iPod touch or Android terminal) to the projector.

A web browser is required for the setting. Prepare a computer which satisfies the following conditions beforehand.

OS (Operating System)	Web browser
Windows 7/Windows 8/Windows 8.1	Internet Explorer 10.0/11.0 • Except for Internet Explorer 10 for Windows 8 Modern UI and Internet Explorer 11 for Windows 8.1 Modern UI. Google Chrome 33
Mac OS X v10.6/Mac OS X v10.7/Mac OS X v10.8/Mac OS X v10.9	Safari 5.0/6.0/7.0
Android 4.1/4.2/4.3/4.4	Google Chrome
iOS 6/7	Safari 6.0/7.0

Procedure of signage setting

The procedure to perform signage setting with the Content Manager is as follows. For details, refer to the corresponding reference pages.

Playing by registering a schedule

- 1) Insert an SD card in the SD card slot. (➔ page 50)
- 2) Connect the client computer (including iPad/iPhone/iPod touch or Android terminal) and the projector via LAN. (➔ page 101)
- 3) Access the projector from the web browser, and log in to the Content Manager. (➔ page 129)
- 4) On the start screen, click the [Schedule] button.
- 5) Create a timetable. (➔ page 133)
- 6) Register a schedule. (➔ page 158)

7) Start playing the schedule. (⇒ page 166)

Note

- When using the Content Manager, make sure to release the write protect switch of the SD card. (⇒ page 49)
- Data such as schedules, timetables, and contents created or registered with the Content Manager are saved in the “PRIVATE” folder in the SD card. If the “PRIVATE” folder does not exist in the SD card when logging in to the Content Manager, the “PRIVATE” folder will be automatically created.
- When the “PRIVATE” folder in the SD card is deleted on the computer, data such as schedules, timetables, and contents created or registered using the Content Manager will be lost.
- If the [SETUP] menu → [ECO MANAGEMENT] → [STANDBY MODE] (⇒ page 72) is set to [ECO] or [NETWORK], and the projector is in standby state, you cannot log in to the Content Manager of the projector from the client computer.
- To switch to the [Slideshow] operation after clicking [Schedule] on the start screen, log out from the Content Manager once and log in again.

Playing by registering the slideshow setting



- 1) Insert an SD card in the SD card slot. (⇒ page 50)
- 2) Connect the client computer (including iPad/iPhone/iPod touch or Android terminal) and the projector via LAN. (⇒ page 101)
- 3) Access the projector from the web browser, and log in to the Content Manager. (⇒ page 129)
- 4) On the start screen, click the [Slideshow] button.
- 5) Register a slideshow setting. (⇒ page 186)
- 6) Start the slideshow. (⇒ page 193)

Note

- When using the signage playback function and the signage setting function, make sure to release the SD card write protect switch. (⇒ page 49)
- Data such as slideshow settings and contents registered with the Content Manager are saved in the “PRIVATE” folder in the SD card. If the “PRIVATE” folder does not exist in the SD card when logging in to the Content Manager, the “PRIVATE” folder will be automatically created.
- When the “PRIVATE” folder in the SD card is deleted on the computer, data such as slideshow settings and contents registered using the Content Manager will be lost.
- If the [SETUP] menu → [ECO MANAGEMENT] → [STANDBY MODE] (⇒ page 72) is set to [ECO] or [NETWORK], and the projector is in standby state, you cannot log in to the Content Manager of the projector from the client computer.
- To switch to the [Schedule] operation after clicking [Slideshow] on the start screen, log out from the Content Manager once and log in again.

Description of the signage playback screen

Icons displayed in the upper right of the projection screen during signage playback (schedule/slideshow) indicate the following.

Icon	Meaning
	Indicates that signage playback (schedule/slideshow) is not available because no SD card is inserted in the SD card slot, the playback content file in the SD card is corrupted, or other reasons.
	Indicates that signage playback (schedule/slideshow) is being paused.

Accessing from the web browser

Connect the client computer (including iPad/iPhone/iPod touch or Android terminal) and the projector on one-to-one correspondence.

Attention

- If the web browser is closed while the Content Manager is used, the login state is retained. Therefore, login is not possible with the same rights for a while (up to 20 minutes). **Make sure to log out from the Content Manager before closing the web browser.**
- If the user takes the computer and moves out of the radio wave area while the Content Manager is used via wireless LAN and communication is interrupted, the login state is retained. Therefore, login is not possible with the same rights for a while (up to 20 minutes). Perform operations in the area where stable communication is possible while the Content Manager is used.

Logging in to the Content Manager

Start up the web browser and log in to the Content Manager.

- 1) Start up the web browser on the computer.

2) Enter “http://xxx.xxx.xxx.xxx/signage/” in the URL entry field of the web browser.

- xxx.xxx.xxx.xxx is the IP address set in the projector.
- The login screen is displayed.

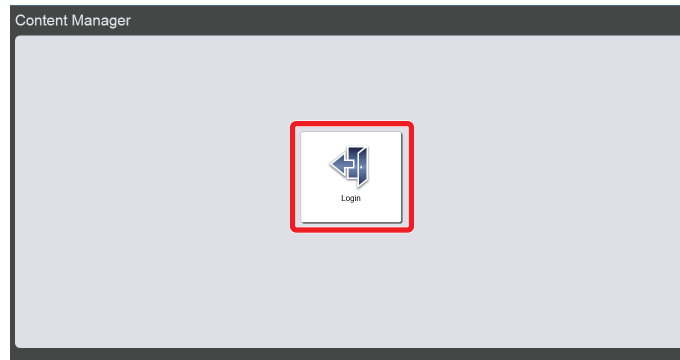

3) Click [Login].

4) Enter the user name and the password.

- The factory default setting of the user name is user1 (user rights)/admin1 (administrator rights) and the password is panasonic (lower case).

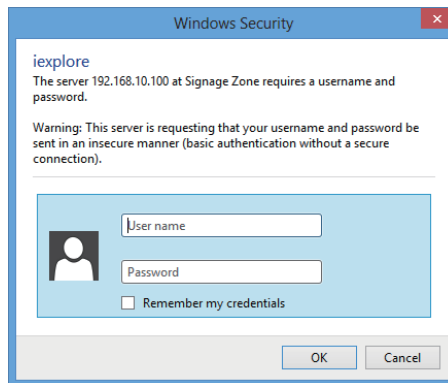

5) Click the [OK] button.

- The start screen is displayed.

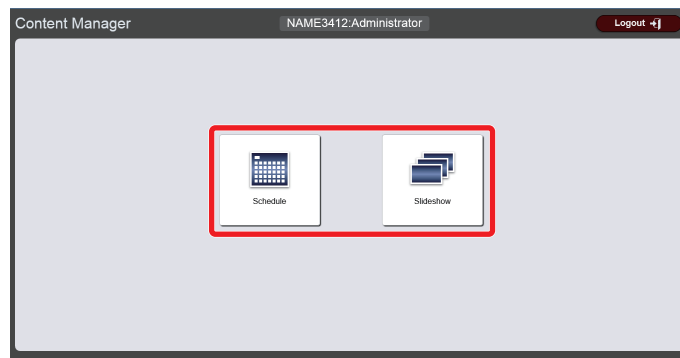

6) Click [Schedule] or [Slideshow].

- The [Schedule] screen or the [Slideshow] screen is displayed.

Note

- Log in with the administrator rights first, and click [Schedule] to change the password. (“Changing login information” (➔ page 181))
- The user name/password of the Content Manager are managed separately from the user name/password of the web control function.
- One person each can log in with administrator rights and with user rights. Two people cannot log in with the same rights, or more than three people cannot log in at the same time.
- If you log in with the administrator rights, you can use all Content Manager functions. If you log in with the user rights, you can check registered schedules or timetables, and the content of preset slideshow, but cannot register, edit, or play them.
- When no SD card is inserted in the SD card slot, or the projector cannot recognize the SD card, the person will be logged out forcibly.
- If the Content Manager screen is not displayed, consult your network administrator.

- The Content Manager of the projector can also be started from “Wireless Manager ME6.2” which is image transfer application software compatible with Windows computers and Mac, Panasonic image transfer application software compatible with iPad/iPhone/iPod touch and Android terminals, and “Multi Projector Monitoring & Control Software” which is software to monitor and control multiple projectors connected via LAN.
For details of “Wireless Manager ME6.2” and “Multi Projector Monitoring & Control Software”, refer to the respective operating instructions on the supplied CD-ROM. For the image transfer application software compatible with iPad/iPhone/iPod touch, and Android terminals, refer to the following URL.

<http://panasonic.net/avc/projector/>

- Screen illustration of the computer
Descriptions in this manual assume “Windows 8” as the OS and “Internet Explorer 10” as the web browser. Depending on the type of the OS, web browser, or computer you use, the screen size or display may differ from the ones shown in this manual. In addition, the “file selection screen” in the following operation procedures uses the OS standard functions.

Logging out from the Content Manager

Terminate signage setting (schedule/slideshow) and log out from the Content Manager.

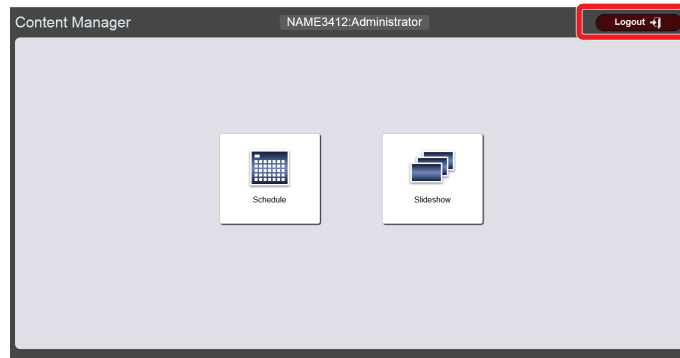

- 1) **Click the [Logout] button on the top right of the screen.**
 - Logout from the Content Manager is complete, and the login screen is displayed.
- 2) **Click the close button of the web browser to exit.**
 - To use the Content Manager again, access the projector from the web browser. (“Logging in to the Content Manager” (➡ page 129))

Note

- Other than the start screen, you can also log out on the [Schedule] screen or the [Slideshow] screen.

[Schedule]

Register, edit, or play schedules for playing still image/movie/music files inside an SD card, turning the power off/on, and changing the brightness of the light source.

Note

- Signage playback (schedule) operates based on the local date and time of the projector.

Schedule screen

Click [Schedule] on the start screen to display the schedule screen.

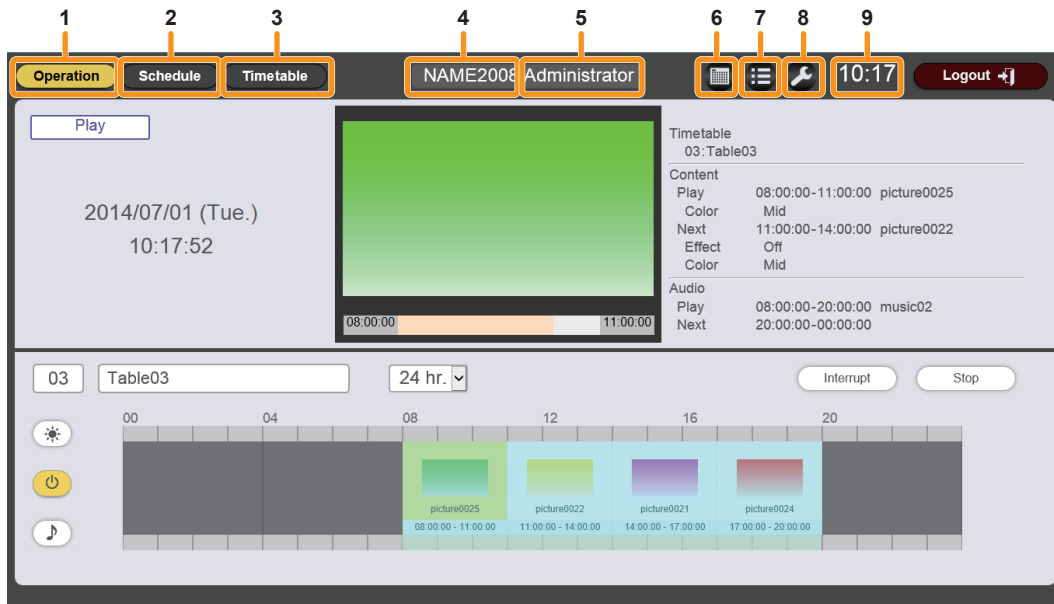

1 [Operation] button

Click this to display the operational information page. Check the information of the content being played or check the assigned schedule. ("Checking the operational information of a schedule" (➔ page 165)) Also, operate schedule playback ("Starting playback of a schedule" (➔ page 166)) or set interruption playback ("Setting interruption playback" (➔ page 167)).

2 [Schedule] button

Click this to display the schedule page. Register a daily schedule. ("Setting a schedule" (➔ page 158))

3 [Timetable] button

Click this to display the timetable page. Register the contents to be played in one day. ("Creating a timetable" (➔ page 133))

4 Projector name

Displays the name of the connected projector.

5 Login rights information

Displays the logged in account rights.

6 Calendar icon

Click this to display the schedule confirmation screen. Check the registered schedule. ("Checking a schedule" (➔ page 173))

7 History icon

Click this to display the history screen. Check the played content. ("Checking the playback history" (➔ page 174))

8 Settings icon (only for administrator rights)

Click this to display the setting screen. Perform system setting, data management, and login information setting for the schedule. ("Setting a schedule" (➔ page 176))

9 Projector time

Displays the time of the connected projector.

Creating a timetable

Set the content details to be played in one day, playback time, and playback sequence as a timetable.

■ Timetable page

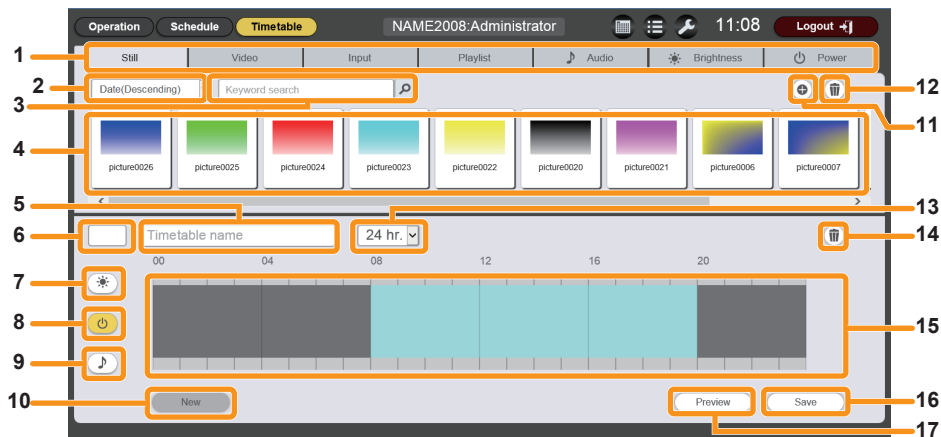

1 Content selection tab

Select the type of content to register in a timetable. Clicking the tab changes the “Content list” display.

2 Sort content

Select the display order of the “Content list”.

[Date(Ascending)]/[Date(Descending)]:

Displays contents in the order of registration date.

[Content name(Ascending)]/[Content name(Descending)]:

Displays contents in the name order.

[File name(Ascending)]/[File name(Descending)]:

Displays contents in the file name order.

3 [Keyword search]

Enter string to be searched and click to search contents in the “PRIVATE” folder in the SD card. Search target varies depending on the content.

Still image/movie/music content:

Content name and file name

Playlist:

Playlist name

Brightness content:

Brightness

Search result is displayed in the “Content list”.

4 Content list

Displays the content registered in the SD card.

5 [Timetable name]

Enter a timetable name.

Or, the timetable name being edited is displayed. Click it to edit the timetable name.

6 Timetable ID

Displays the ID of the timetable being edited.

It is assigned automatically when a timetable is registered.

7 Brightness content display icon

This icon becomes yellow when selected, and displays the registered brightness content in a timetable. Click the icon again to cancel the selection, then the icon color changes to white.

8 Power supply content display icon

This icon becomes yellow when selected, and displays the registered power supply content in a timetable. Click the icon again to cancel the selection, then the icon color changes to white.

9 Music content display icon

This icon becomes yellow when selected, and displays the registered music content in a timetable. Click the icon again to cancel the selection, then the icon color changes to white.

10 [New] button (only for administrator rights)

Click this to discard the timetable being edited and create a new timetable.

11 Content addition icon (only for administrator rights)

Adds and registers contents in the SD card. (“Registering content in a content list” (➔ page 145))

12 Content deletion icon (only for administrator rights)

Deletes contents registered in the SD card. (“Deleting content registered in a content list” (➔ page 147))

13 Display scale

Sets the display scale for “Timetable”.

14 Content in timetable deletion icon (only for administrator rights)

Deletes the content registered in a timetable.

15 Timetable

Displays the content registered in a timetable.

16 [Save] button (only for administrator rights)

Click this to register the timetable setting being edited in the SD card.

17 [Preview] button

Click this to display the timetable being edited on the web browser, or to display the preview of it on the projection screen. (“Displaying preview of timetable details” (➔ page 143))

■ Procedure for creating timetables

1) On the start screen, click [Schedule].

- The schedule screen is displayed.

2) Click the [Timetable] button.

- The timetable page is displayed.

The following screen is an example when the Content Manager is used for the first time or new SD card is inserted.

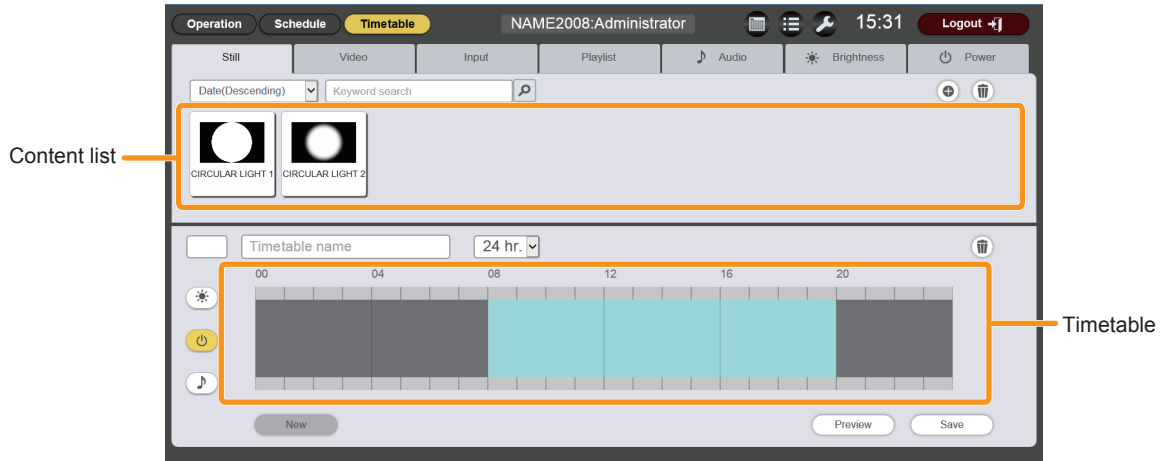

3) Register a content in the content list.

- To register still image/movie/music contents in the timetable, register still image/movie/music files in the content list in advance. For details on registration procedure, refer to “Registering content in a content list” (➡ page 145).
- To register multiple still image/movie/external input contents together as a playlist in the Content Manager in advance, refer to “Registering playlist” (➡ page 149).

4) Register the content in the timetable.

- Register the content in the content list into the timetable. For details on registration procedure, refer to “Registering content in a timetable” (➡ page 135).

5) Check the timetable content.

- Preview the timetable where the contents are registered.

Note

- After the timetable (content played back in a day) to be used by the specified date or by the day of the week, set the schedule. Refer to “Setting a schedule” (➡ page 158) for details.
- For operations of the timetable or content list, refer to the descriptions of the following items.
 - “Registering content in a timetable” (➡ page 135)
 - “Deleting image content registered in a timetable” (➡ page 137)
 - “Deleting music content registered in a timetable” (➡ page 138)
 - “Deleting brightness content registered in a timetable” (➡ page 139)
 - “Deleting power supply content registered in a timetable” (➡ page 140)
 - “Changing the settings of content registered in a timetable” (➡ page 141)
 - “Displaying preview of timetable details” (➡ page 143)
 - “Registering content in a content list” (➡ page 145)
 - “Deleting content registered in a content list” (➡ page 147)
 - “Editing registration information of content” (➡ page 148)
 - “Creating a playlist” (➡ page 149)

Registering content in a timetable

Register content in a timetable.

■ Timetable page

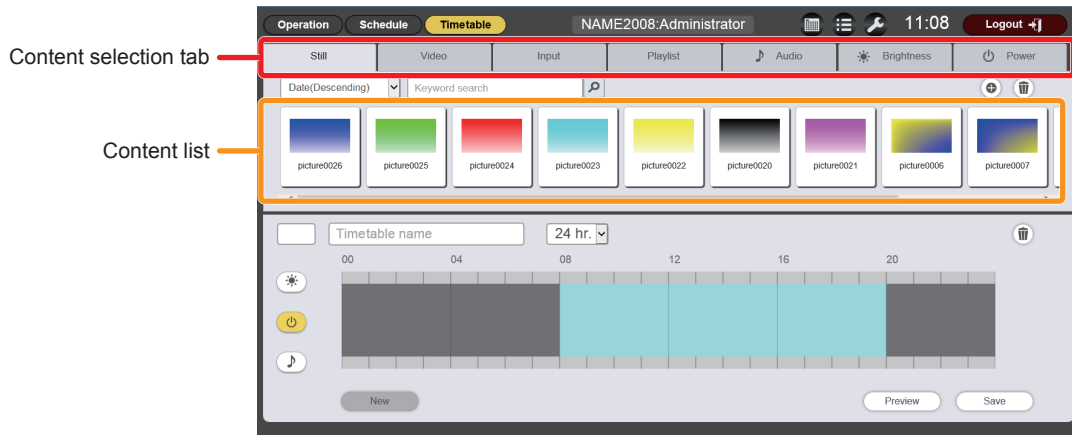

■ [Content registration] screen

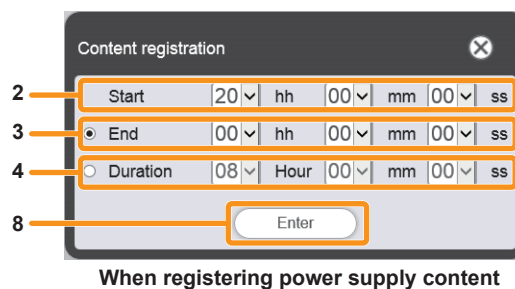
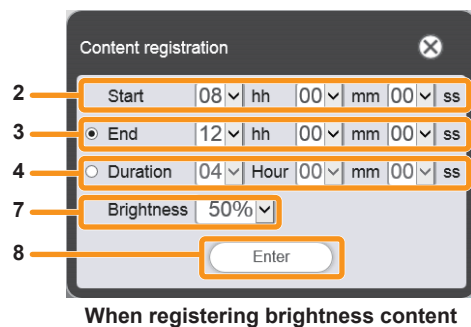
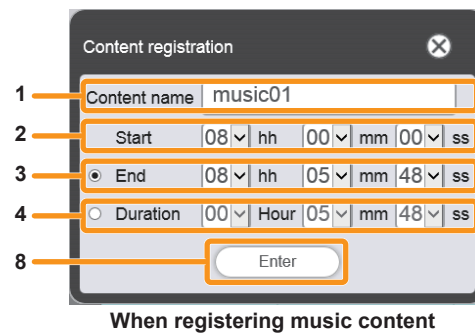
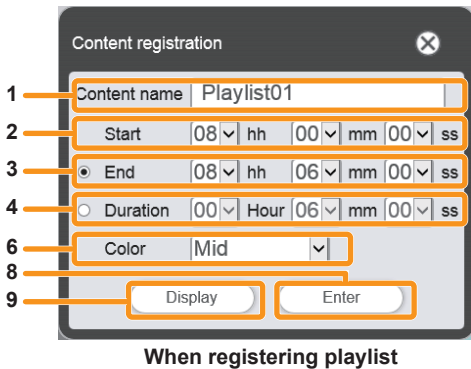
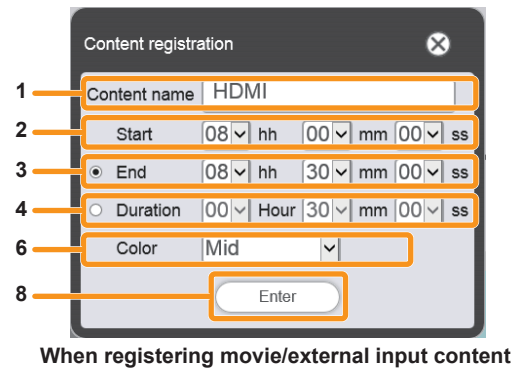
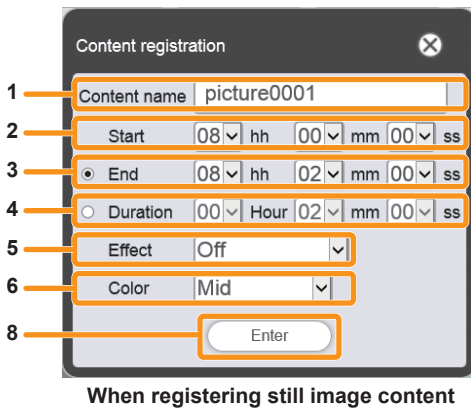

- 1 [Content name]
Displays the selected content name.
- 2 [Start]
Set the time to start playback of the content.

- 3 [End]
Select the radio button, and set the time to end the content playback.

- 4 **[Duration]**
Select the radio button, and set the time to start the content playback.
- 5 **[Effect]**
Set special effects used when changing the playback screen of still image content.
For details of the setting items, refer to “[Effect]” (➔ page 197).
- 6 **[Color]**
Select the color setting to be reflected when playing image content.
For details of the setting items, refer to “[Color]” (➔ page 198).
- 7 **[Brightness]**
Select the brightness to be reflected when playing image content.
- 8 **[Enter] button**
Click this to confirm the settings.
- 9 **[Display] button**
Click this to display the [Playlist edit] screen. (“Editing a playlist” (➔ page 151))

■ Procedure

- 1) **Click the tab of the content to register in the timetable from the “Content selection tab”.**
 - Clicking the tab changes the “Content list” display.
- 2) **Register the content in the timetable.**
 - Drag the content to be registered in the timetable from the “Content list” into the “Timetable”.

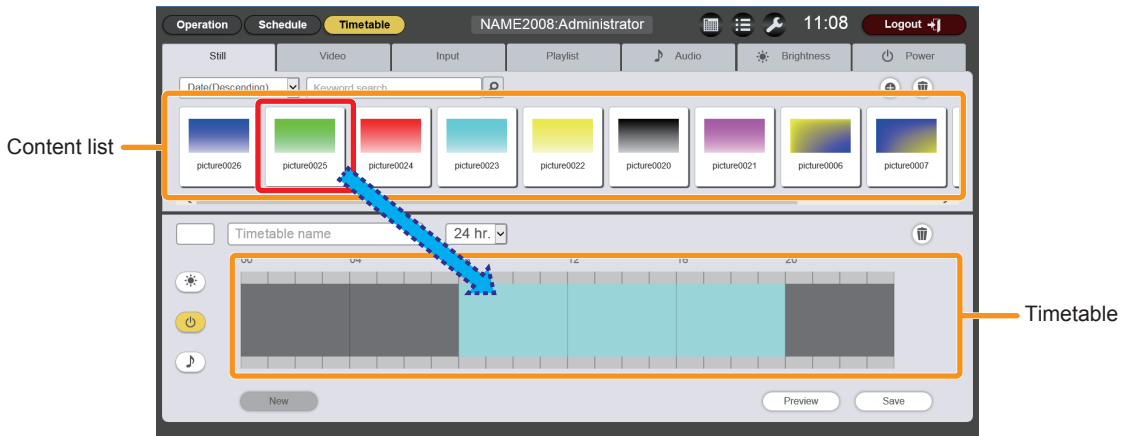

- To add and register new contents (still image/movie/music content only) to the “Content list”, refer to “Registering content” (➔ page 187).
- To register a playlist in the “Content list”, refer to “Registering playlist” (➔ page 149).
- The [Content registration] screen is displayed for each content to register.

3) **Perform various settings, and click the [Enter] button.**

- The content is registered in the “Timetable”.

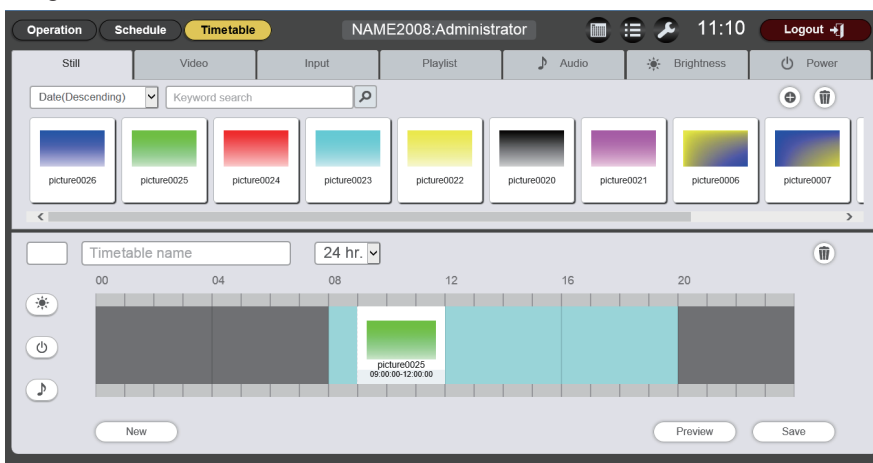

- To continue to add content, go back to Step 1) and perform the procedure.

4) Enter the timetable name.

- Enter a name in the [Timetable name] field. Up to 24 characters in single byte can be input.

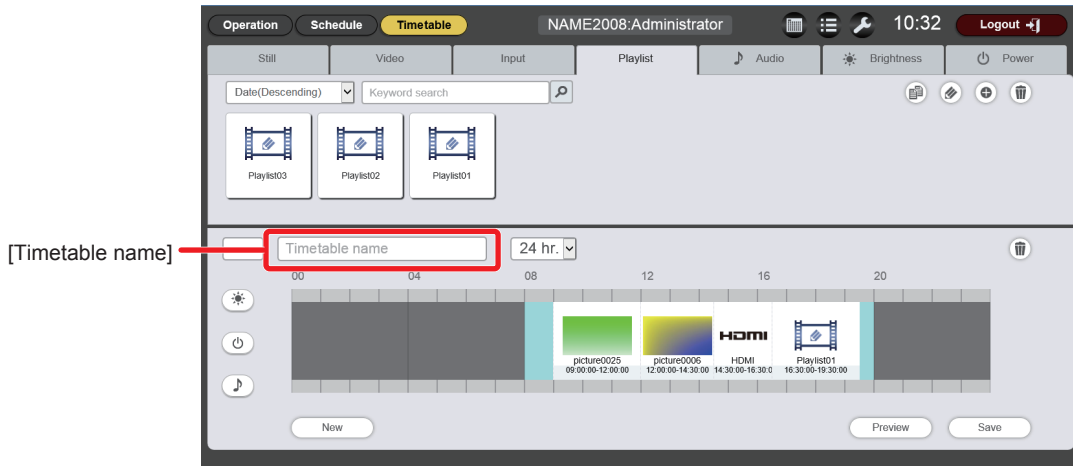

5) Click the [Save] button.

- The created timetable is registered in the SD card.
- A timetable ID is assigned automatically when the timetable is registered.
- To continue to create another timetable, click the [New] button.

Attention

- Register power supply content in a timetable only when the projector is installed in an environment where light from the light source will not enter the eyes of people around the projector even if it starts projection suddenly.

Note

- Up to 99 timetables can be registered.
- Up to 100 contents can be registered in one timetable.
- During playback of movie/external input content, music content is not played.
- If you click the [Save] button without entering the timetable name, the timetable name entry screen is displayed. Enter the timetable name, and click the [Enter] button.

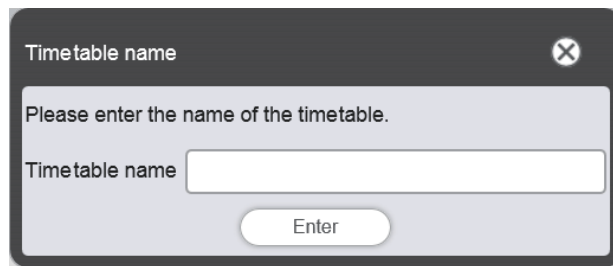

Deleting image content registered in a timetable

Delete image content (still image/movie/external input content, playlist) registered in a timetable.

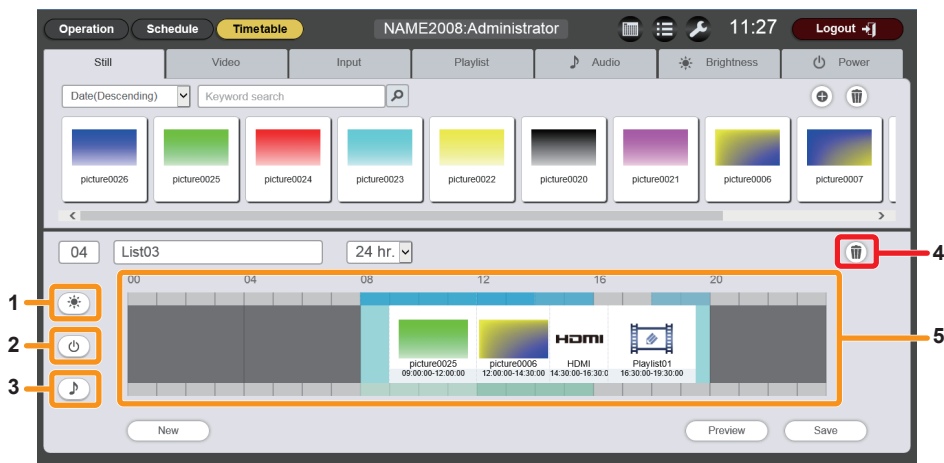

- 1 Brightness content display
- 2 Power supply content display

- 3 Music content display
- 4 Content in timetable deletion

5 Timetable

1) Make sure , , and  are not selected.

- If any of the icons is displayed in yellow, click the icon to release the selection.

2) Click .

- The mode changes to deletion mode.

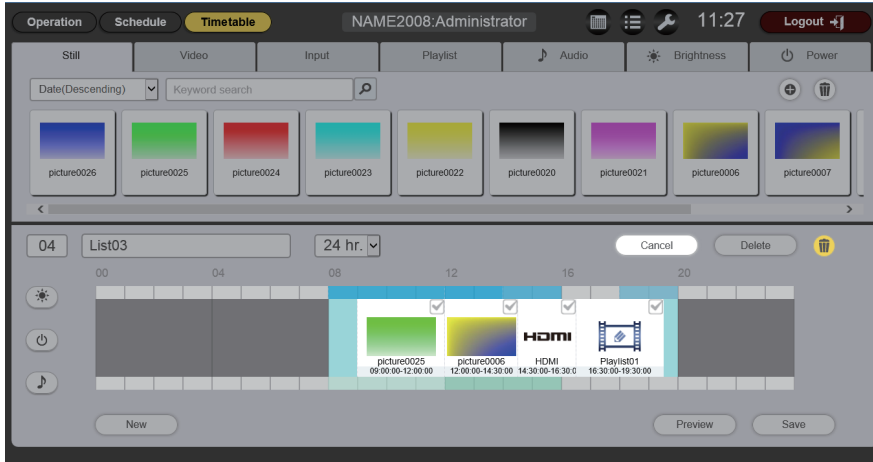

3) Select the image content to delete.

- You can select multiple contents.

4) Click the [Delete] button.

5) When the confirmation screen is displayed, click the [OK] button.

- The selected image content is deleted from the timetable.
- Deleting content from the timetable will not delete the content from the SD card.

Deleting music content registered in a timetable

Delete music content registered in a timetable.

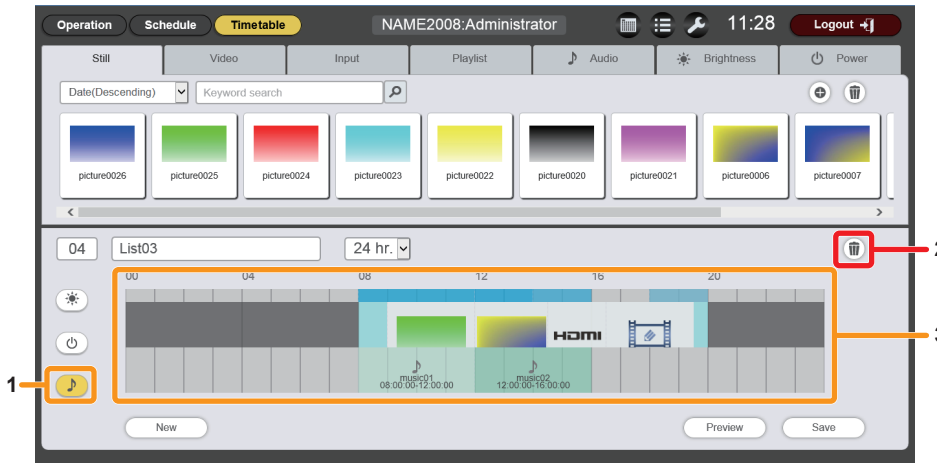

1 Music content display

3 Timetable

2 Content in timetable deletion

1) Click  to select it.

- When selected, the icon color changes to yellow.
- When the icon is displayed in white, it is not selected. Click the icon again.

2) Click .

- The mode changes to deletion mode.

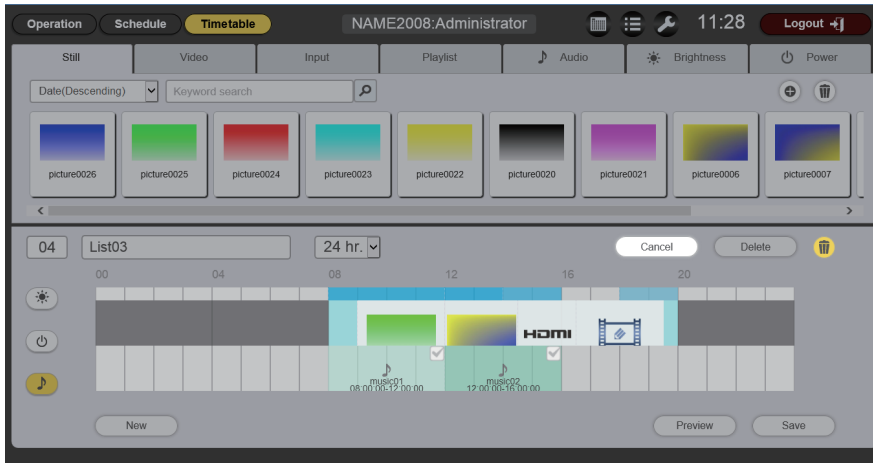

3) Select the music content to delete.

- You can select multiple contents.

4) Click the [Delete] button.

5) When the confirmation screen is displayed, click the [OK] button.

- The selected music content is deleted from the timetable.

Deleting brightness content registered in a timetable

Delete brightness content registered in a timetable.

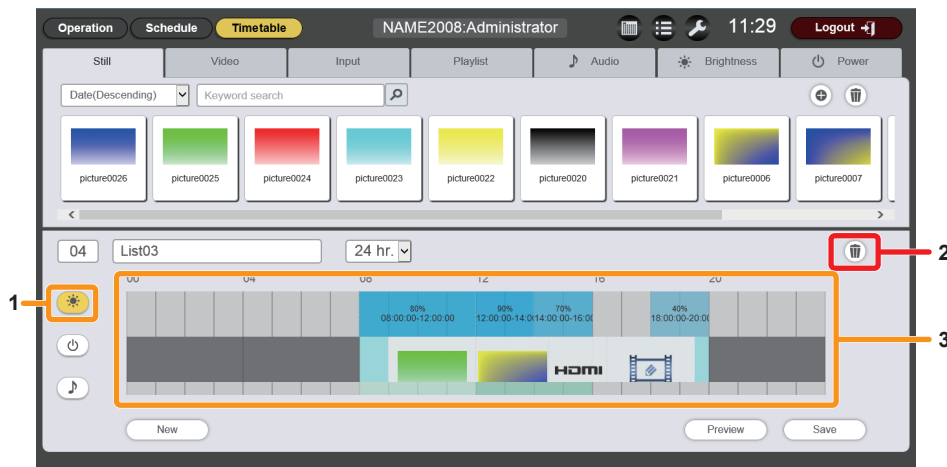

1 Brightness content display

3 Timetable

2 Content in timetable deletion

1) Click  to select it.

- When selected, the icon color changes to yellow.
- When the icon is displayed in white, it is not selected. Click the icon again.

2) Click .

- The mode changes to deletion mode.

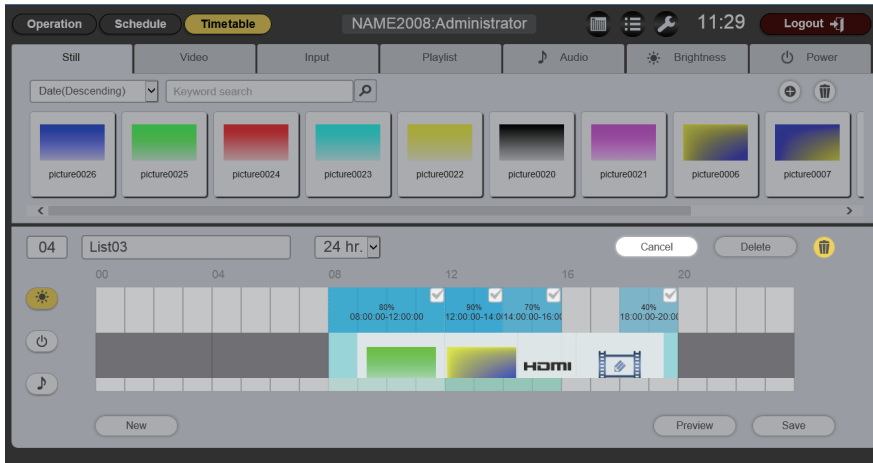

3) Select the brightness content to delete.

- You can select multiple contents.

4) Click the [Delete] button.

5) When the confirmation screen is displayed, click the [OK] button.

- The selected brightness content is deleted from the timetable.

Deleting power supply content registered in a timetable

Delete power supply content registered in a timetable.

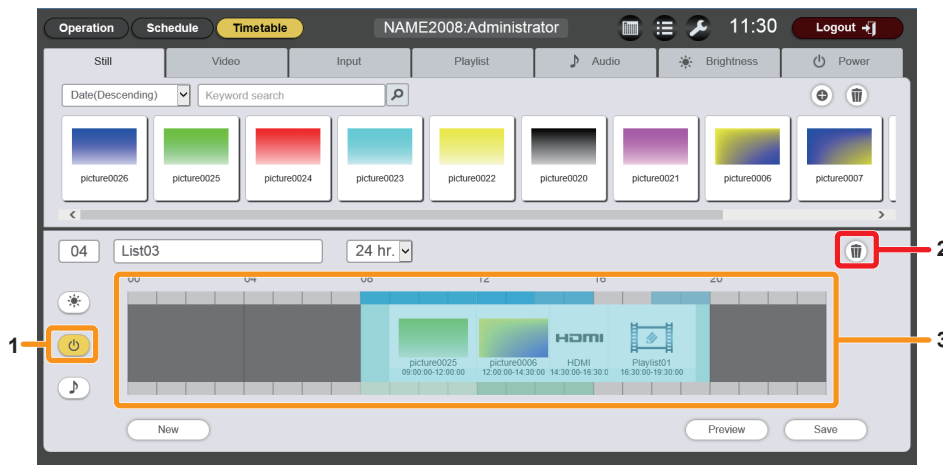

1 Power supply content display

3 Timetable

2 Content in timetable deletion

1) Click  to select it.

- When selected, the icon color changes to yellow.
- When the icon is displayed in white, it is not selected. Click the icon again.

2) Click .

- The mode changes to deletion mode.

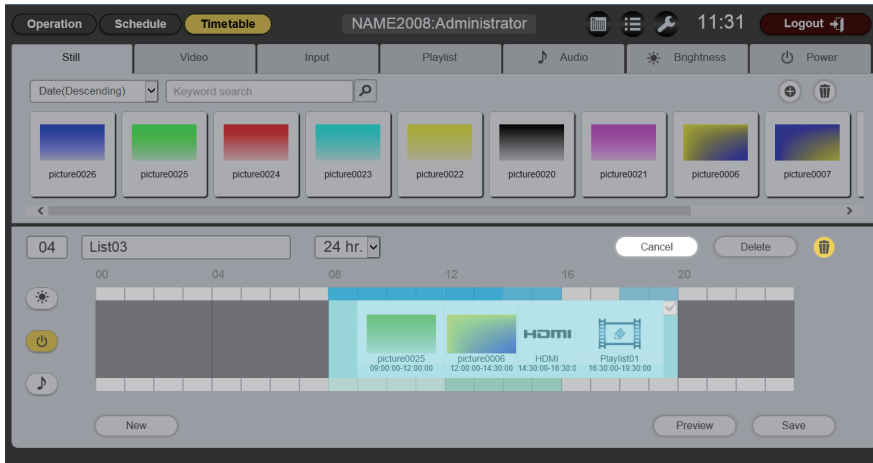

3) Select the power supply content to delete.

- You can select multiple contents.

4) Click the [Delete] button.

5) When the confirmation screen is displayed, click the [OK] button.

- The selected power supply content is deleted from the timetable.

Changing the settings of content registered in a timetable

Change the settings of content registered in a timetable.

■ **Timetable page**

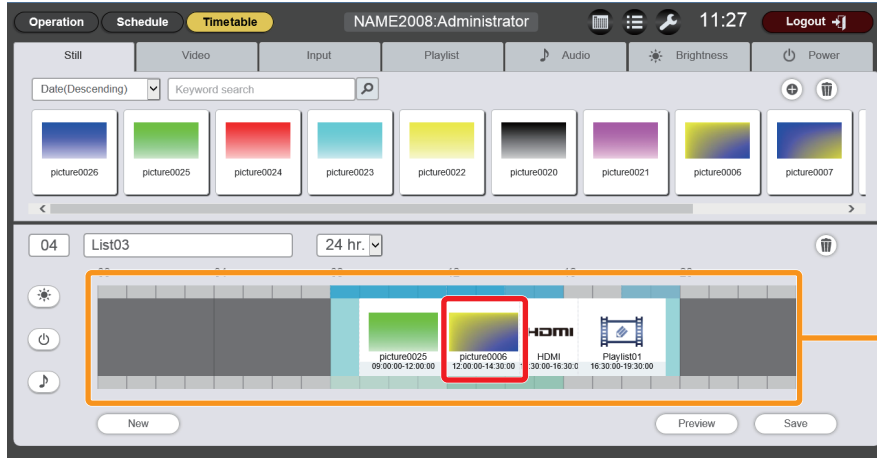

Timetable

■ [Content edit] screen

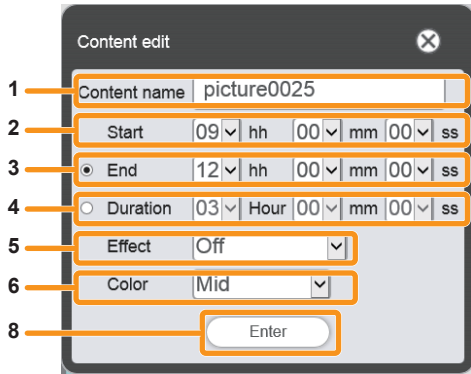

When clicking still image content

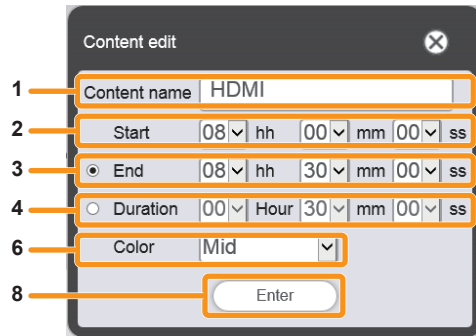

When clicking movie/external input content

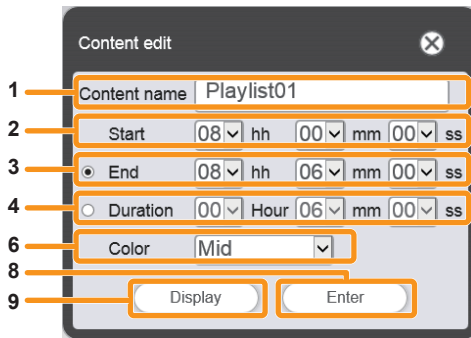

When clicking playlist

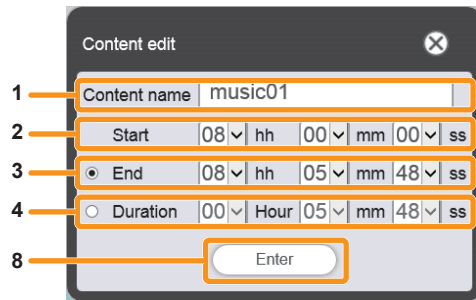

When clicking music content

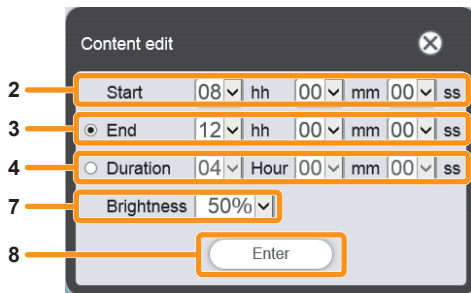

When clicking brightness content

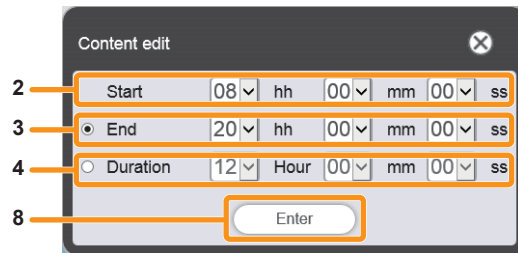

When clicking power supply content

- 1 **[Content name]**
Displays the selected content name.
- 2 **[Start]**
Set the time to start playback of the content.
- 3 **[End]**
Select the radio button, and set the time to end the content playback.
- 4 **[Duration]**
Select the radio button, and set the time to start the content playback.
- 5 **[Effect]**
Set special effects used when changing the playback screen of still image content.
For details of the setting items, refer to "[Effect]" (➔ page 197).

- 6 **[Color]**
Select the color setting to be reflected when playing image content.
For details of the setting items, refer to "[Color]" (➔ page 198).
- 7 **[Brightness]**
Select the brightness to be reflected when playing image content.
- 8 **[Enter] button**
Click this to confirm the settings.
- 9 **[Display] button**
Click this to display the [Playlist edit] screen. ("Editing a playlist" (➔ page 151))

■ Procedure

- 1) On the "Timetable", click the content of which setting you want to change.
 - The [Content edit] screen is displayed for each content of which setting is to be changed.
- 2) Perform various settings, and click the [Enter] button.
 - The setting of the content registered in the "Timetable" is updated.

Note

- When you click the [Enter] button after changing [Brightness] of brightness content, the content is registered in the SD card and displayed in

the “Content list”.

Displaying preview of timetable details

Display the preview image of a timetable on the web browser of on the projection screen.

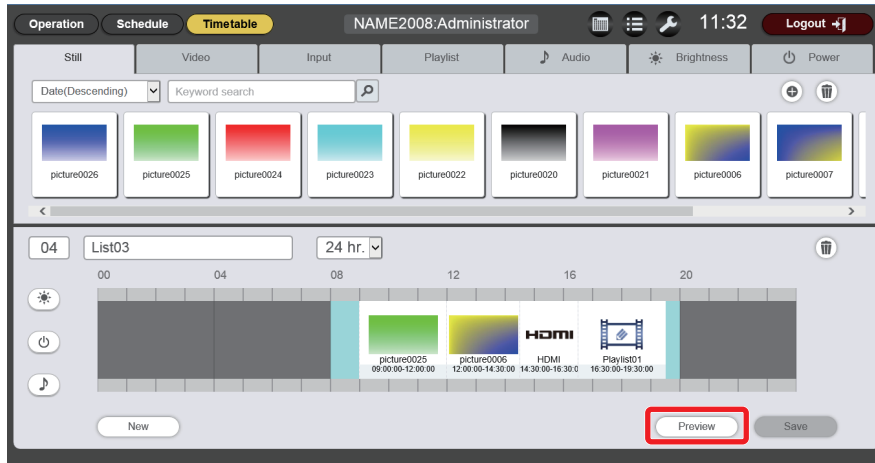

1) Click the [Preview] button in the timetable page.

- The preview mode selection screen is displayed.

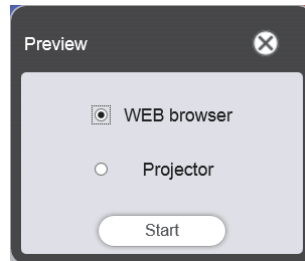

2) Select a preview mode, and click the [Start] button.

- When [WEB browser] is selected, the image is displayed on the web browser.
- When [Projector] is selected, the image is displayed on the projection screen.

Note

- In the following cases, the projector mode [Projector] is not available.
 - During signage playback (schedule/slideshow)
 - When the input is other than signage
 - When the projection mode is lighting mode

■ Preview mode [WEB browser]

- A preview screen like the following is displayed on the web browser.

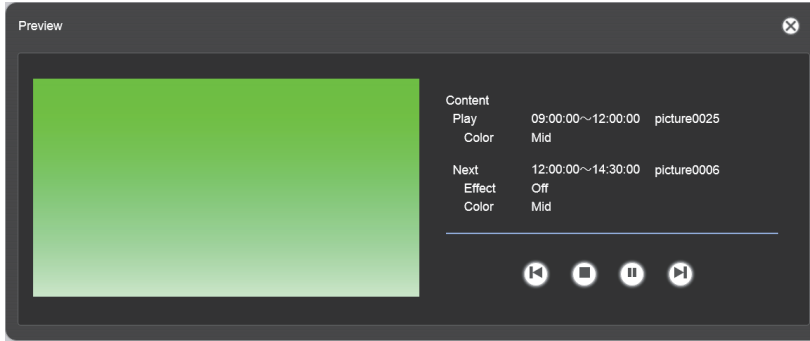

Operation icon	Performance
	Switches to the previous content.
	Stops playback.
	Starts or pauses playback. The icon display changes depending on the playback state.
	Switches to the next content.

Note

- When there is a blank period between contents, the period is handled as one content and displayed in preview.
- Regardless of the content setting, each content including blank periods is played for 10 seconds.
- In the case of movie/external input content, only an icon is displayed on the preview screen instead of the actual image.
- Image effects and color settings are not reflected in preview images.
- Music/brightness/power supply content are not included in preview.

■ Preview mode [Projector]

- Preview image is displayed on the projection screen.
- An operation screen is displayed on the web browser as follows.

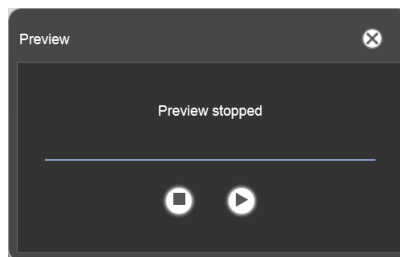

Operation icon	Performance
	Stops playback.
	Starts or pauses playback. The icon display changes depending on the playback state.

Note

- When there is a blank period between contents, the period is handled as one content and displayed in preview.
- Regardless of the content setting, still image content is played for 10 seconds, movie/external input content is played for 20 seconds, and blank period is played for 10 seconds.
- As for music content, the one registered at the playback start time of still image content is reflected.
- As for brightness content, the one registered at the playback start time of image content (still image/movie/external input) is reflected.
- Power supply content is not included in preview.
- If paused during playback of still image content, or during a blank period between contents, the playback time of the content being paused is reset when it is resumed, and the content is played from the beginning. In the case of movie/external input content, the playback resumes from the paused part.

Editing the content list

Register or delete still image/movie/music content to be registered in a timetable, and edit the registration information.

Refer to the descriptions of the following items.

- “Registering content in a content list” (➔ page 145)
- “Deleting content registered in a content list” (➔ page 147)
- “Editing registration information of content” (➔ page 148)
- “Creating a playlist” (➔ page 149)

Registering content in a content list

Register still image/movie/music files in the SD card as contents from the client computer.

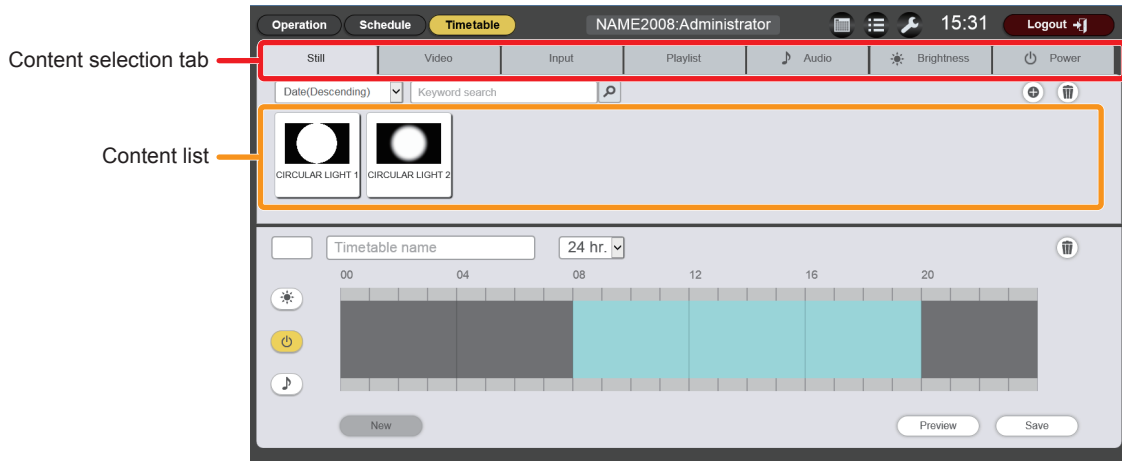

- 1) In the timetable page, click the tab of the content to register among the “Content selection tab”.
 - Clicking the tab changes the “Content list” display.

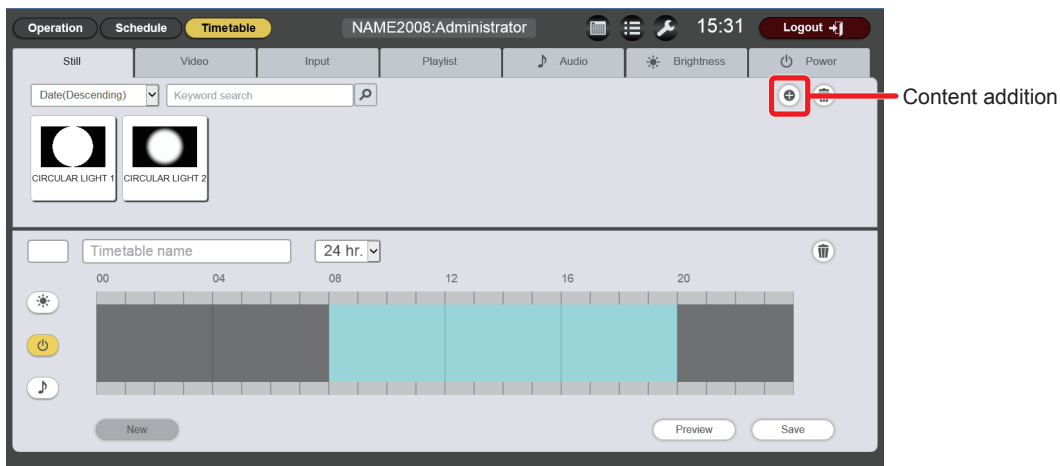

- 2) Click .
 - The [Add content] screen is displayed.



- 3) Click on the [Add content] screen.
 - The file selection screen is displayed.

4) Select the content to register (1 file at a time), and click the [Open] button.

- The content information entry screen is displayed.

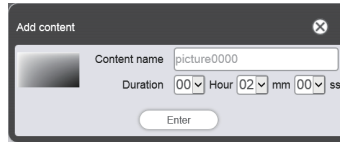

5) Enter any [Content name] and [Duration], and click the [Enter] button.

- For [Content name], up to 24 characters in single byte can be input.
- Even when the content name is different from the file name, the file name itself is not changed.
- [Duration] can be input only for still image content.
- Those are registered in the [Add content] screen.

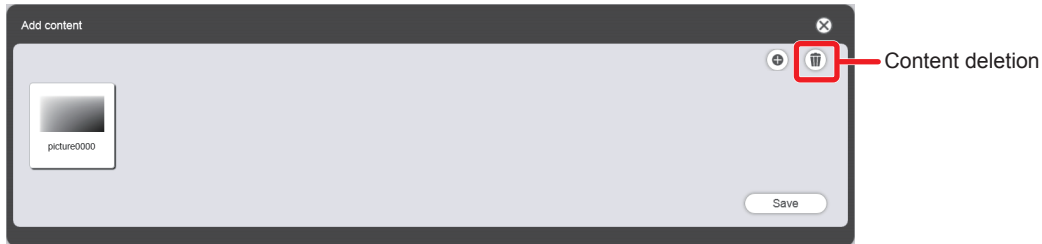

- To continue to add content, go back to Step 3), or to delete content from the [Add content] screen, go to Step 6), and to end adding content, proceed to Step 10).
- Up to 10 contents can be registered in the [Add content] screen.

6) To cancel addition of content, click  on the [Add content] screen.

- The mode changes to deletion mode.

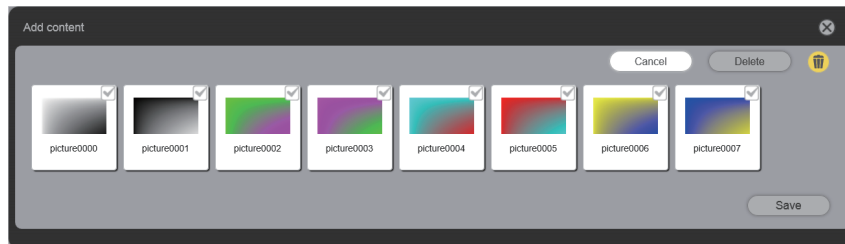

7) Select the content for which you want to cancel addition.

- You can select multiple contents.

8) Click the [Delete] button.

9) When the confirmation screen is displayed, click the [OK] button.

10) When addition of contents to register is complete, click the [Save] button.

- Added contents are registered in the SD card.

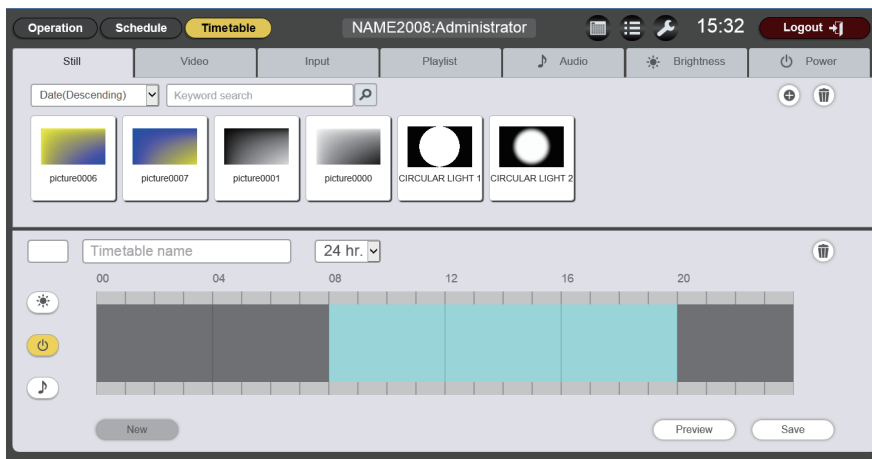

Note

- The maximum number of still image/movie/music files that the Content Manager can control is 500 each. However, it may not be possible to register 500 files depending on the capacity of the SD card.

Deleting content registered in a content list

Delete unnecessary content from the SD card.

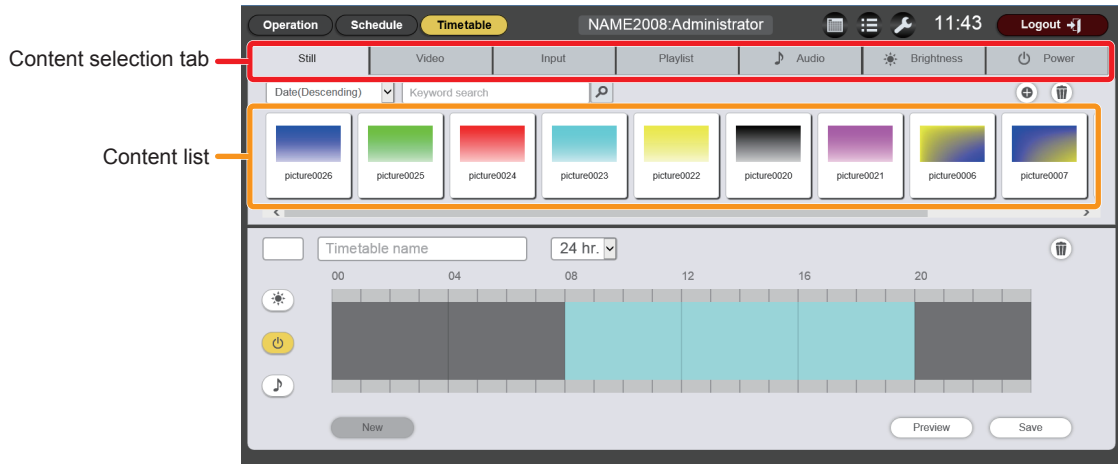

- 1) In the timetable page, click the tab of the content to delete among the “Content selection tab”.
 - Clicking the tab changes the “Content list” display.

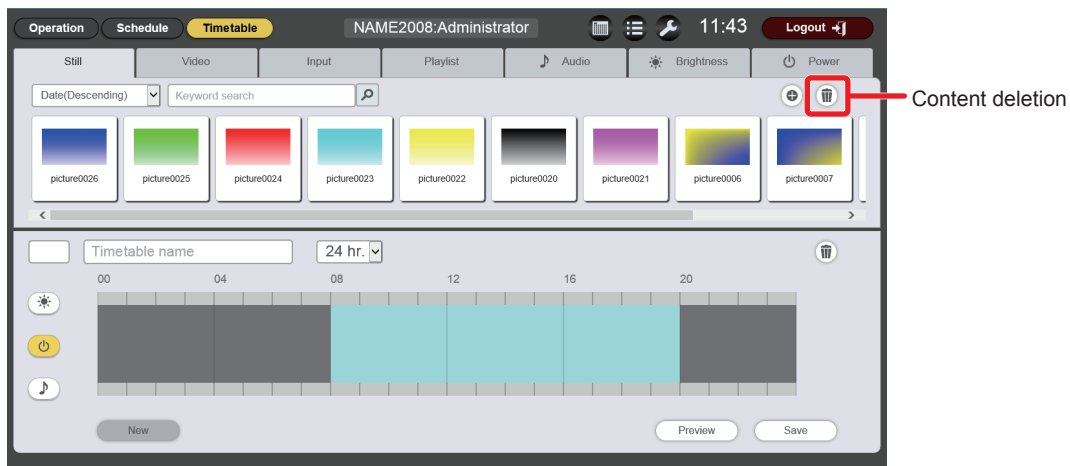

- 2) Click  in the “Content list”.
 - The mode changes to deletion mode.

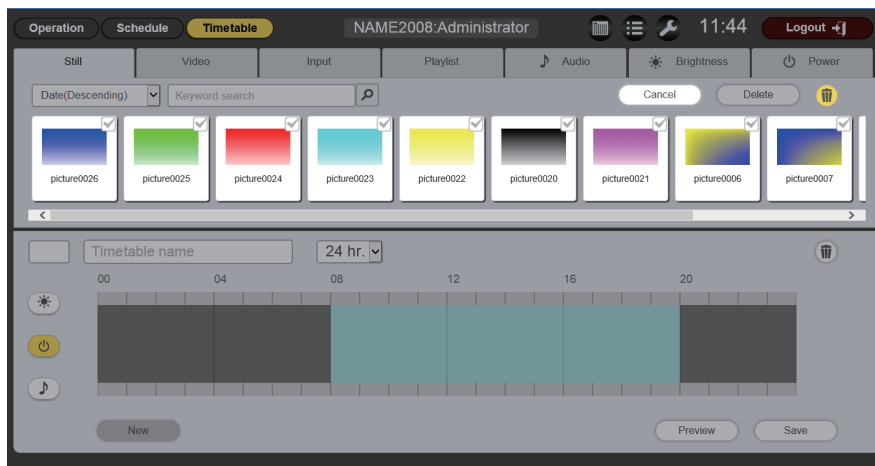

- 3) Select the content to delete.
 - You can select multiple contents.
- 4) Click the [Delete] button.

5) When the confirmation screen is displayed, click the [OK] button.

- The selected content is deleted from the SD card.

Note

- If the content to be deleted is registered in a schedule or slideshow, the content cannot be deleted.
- [CIRCULAR LIGHT1] and [CIRCULAR LIGHT2] in still image content cannot be deleted.

Editing registration information of content

Change the registration information of still image/movie/music contents registered in the content list.

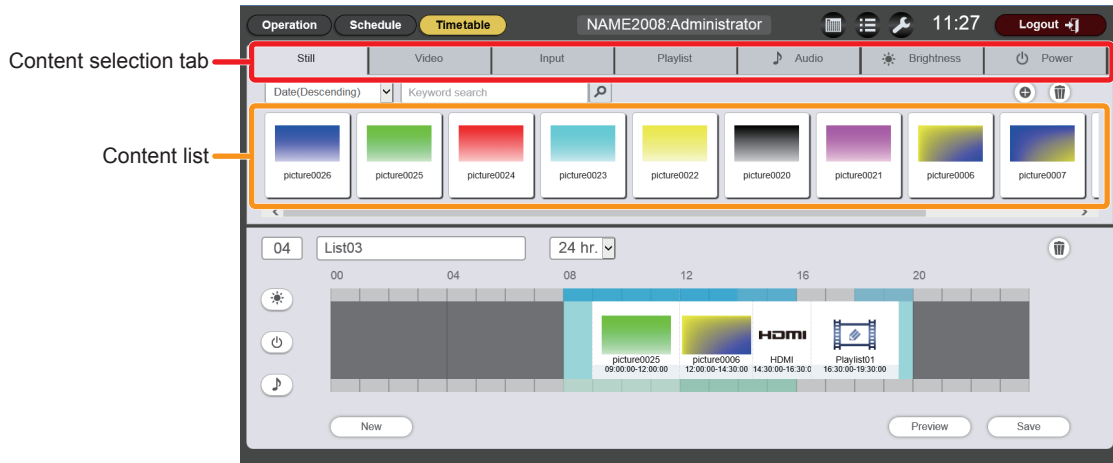

1) In the timetable page, click the tab of the content of which registration information you want to edit from the “Content selection tab”.

- Clicking the tab changes the “Content list” display.

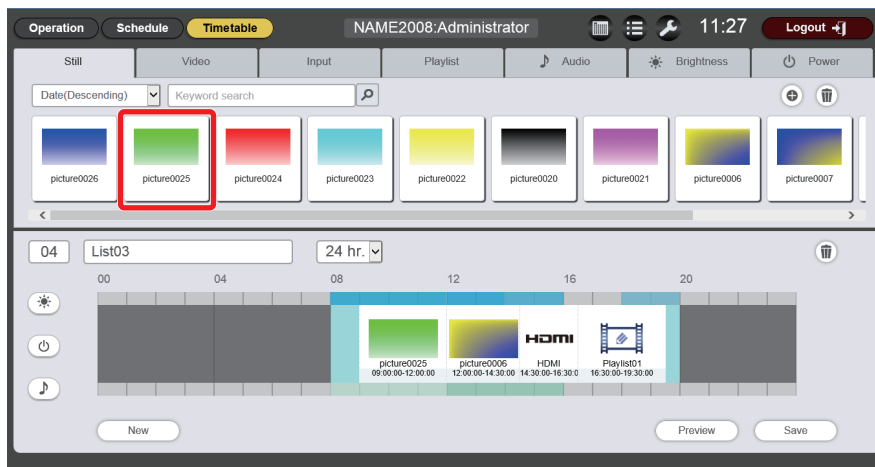

2) In the “Content list”, click the content of which registration information you want to change.

- The [Content edit] screen is displayed.

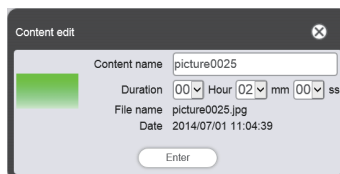

3) Change [Content name] and/or [Duration], and click the [Enter] button.

- You can change [Content name] and [Duration] in the case of still image content, and [Content name] in the case of movie/music content.
- Changed contents are registered in the SD card.

Note

- You cannot edit external input/brightness/power supply content because they do not have registration information.
- To change the contents playlist, refer to “Editing a playlist” (➔ page 151).

Creating a playlist

Register, delete, or edit the playlist where multiple still image/movie/external input contents can be controlled together as a single content.

Refer to the descriptions of the following items.

- “Registering playlist” (➔ page 149)
- “Editing a playlist” (➔ page 151)
- “Deleting content registered in a playlist” (➔ page 153)
- “Changing the settings of content registered in a playlist” (➔ page 153)
- “Duplicating a playlist” (➔ page 154)
- “Displaying preview of playlist contents” (➔ page 155)

Registering playlist

Bundle multiple still image/movie/external input contents and register them as one content called playlist.

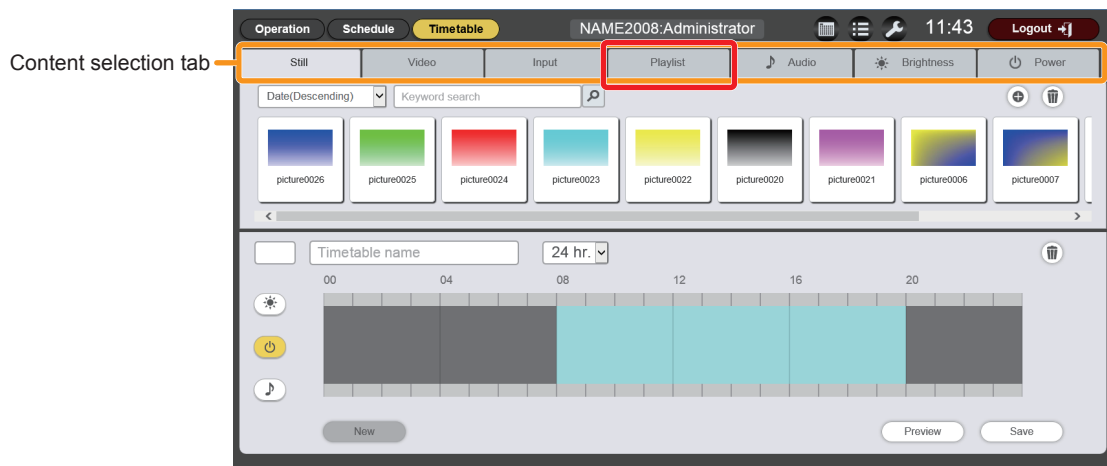

1) In the timetable page, click the [Playlist] tab among the “Content selection tab”.

- The “Content list” shows the list of playlists.

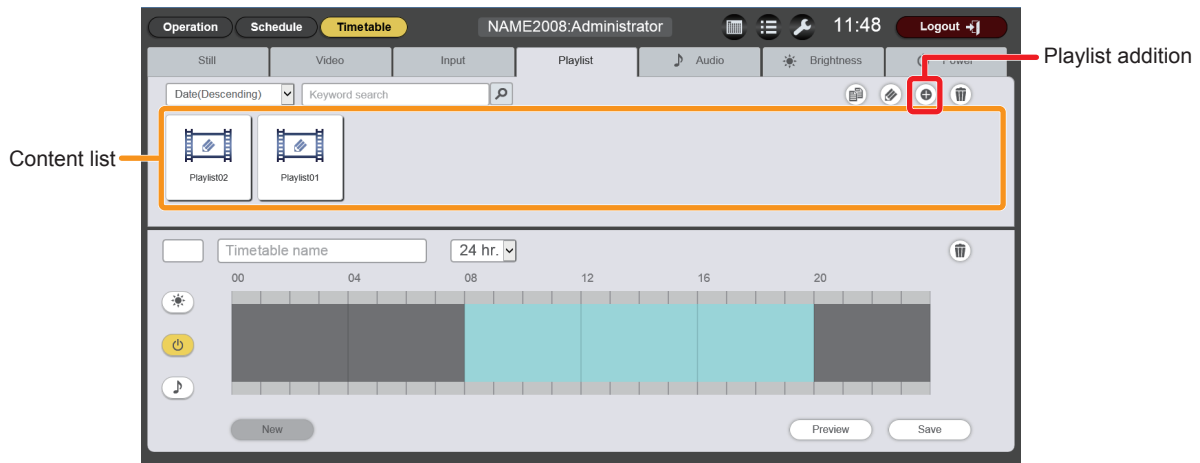

- 2) Click  in the “Content list”.
 - The [Playlist edit] screen is displayed.

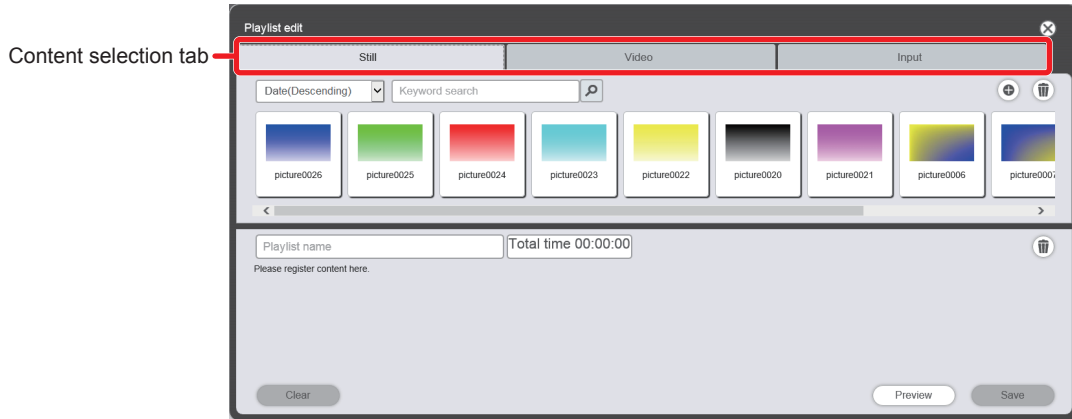

- 3) On the [Playlist edit] screen, click the tab of the content to register in a playlist among the “Content selection tab”.
 - Clicking the tab changes the “Content list” display.
- 4) Register the content in the playlist.
 - Drag and drop the content to be registered in the playlist from the “Content list” into the “playlist”.

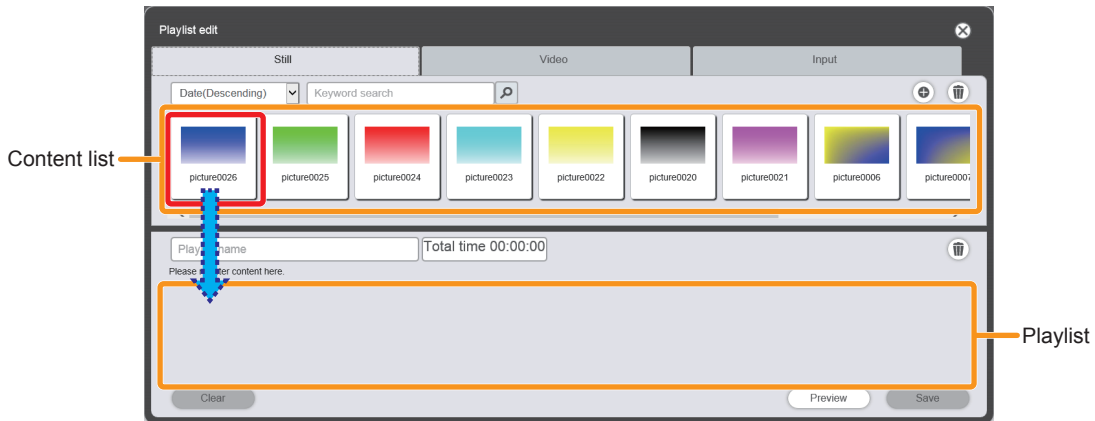

- The [Content registration] screen is displayed.

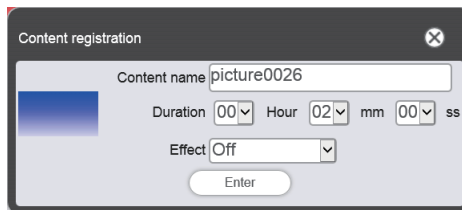

- 5) Input [Duration] and [Effect], and click the [Enter] button.
 - The content is registered in the “playlist”.

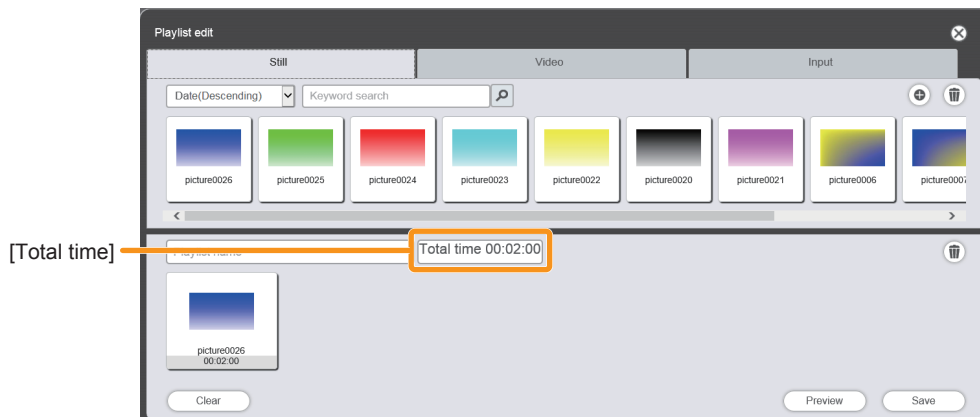

- You can set [Effect] only for still image content.

- To continue to register content, go back to Step 3).
- The total playback time of the contents registered in the “playlist” is displayed in [Total time].
- To make the playlist over again from the start, click the [Clear] button. All the contents in the “playlist” are deleted.

6) Enter a playlist name.

- Enter a name in the [Playlist name] field. Up to 24 characters in single byte can be input.

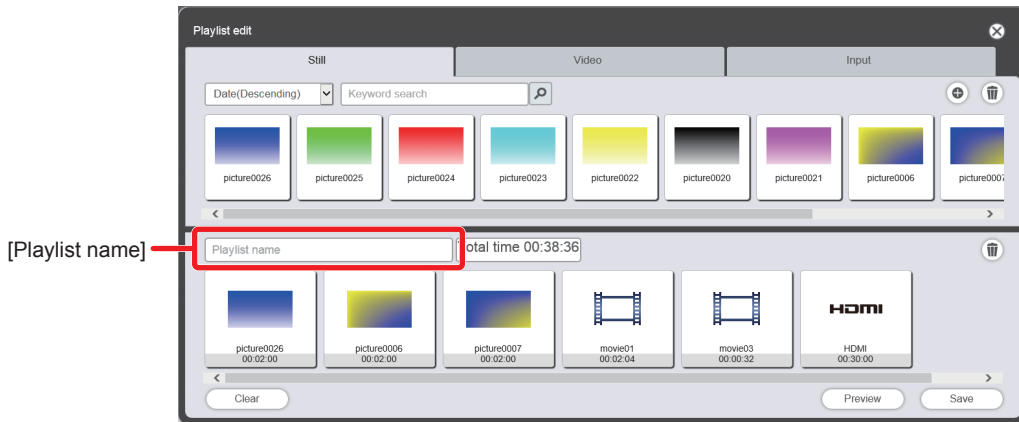

7) Click the [Save] button.

- The created playlist is registered in the SD card.

Note

- Only image content (still image/movie/external input) can be registered in a playlist.
- Up to 100 contents can be registered in one playlist.
- Up to 500 playlists can be registered.
However, it may not be possible to register 500 files depending on the capacity of the SD card.
- If you click the [Save] button without entering the playlist name, the playlist name entry screen is displayed. Enter the playlist name, and click the [Enter] button.

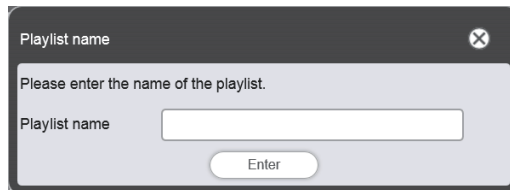

Editing a playlist

Edit the contents of a registered playlist.

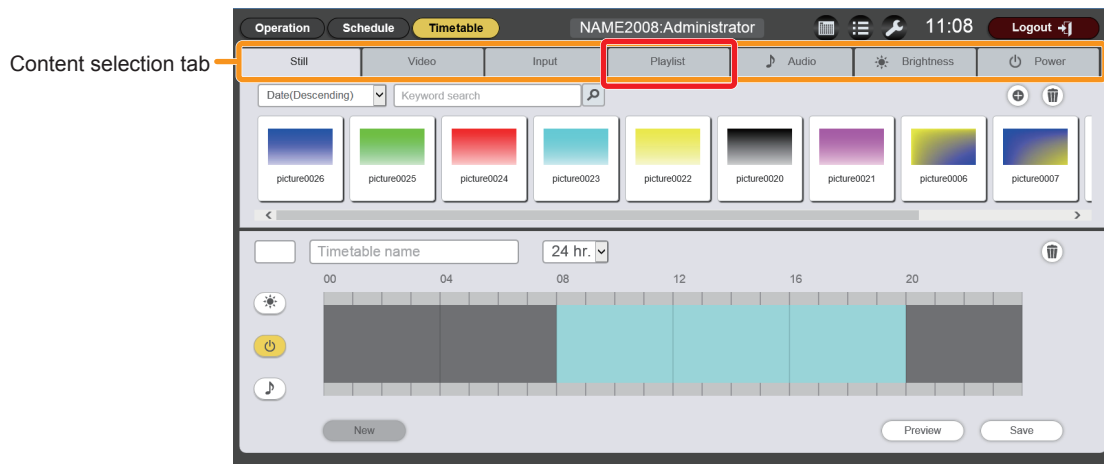

1) In the timetable page, click the [Playlist] tab among the “Content selection tab”.

- The “Content list” shows the list of playlists.

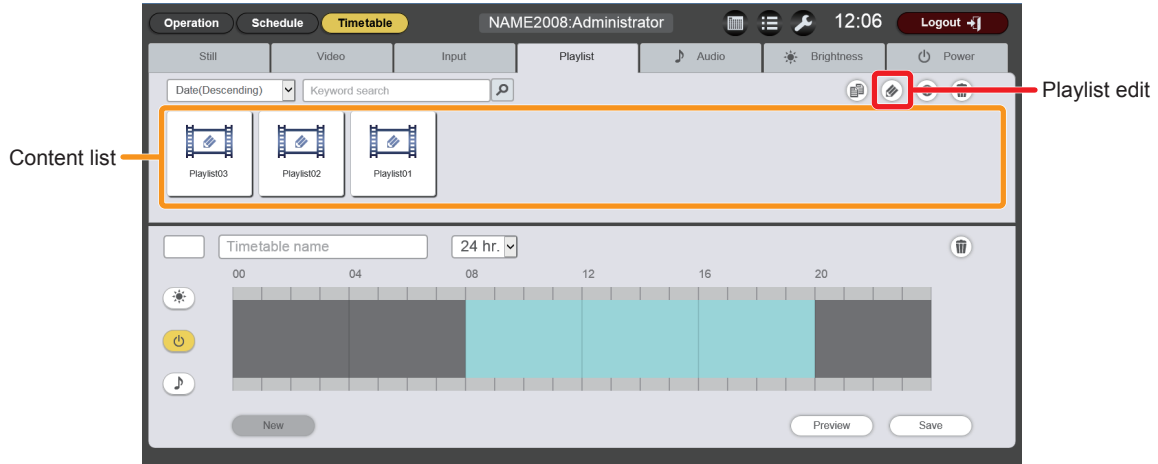

2) Click  in the “Content list”.

- The mode changes to selection mode.

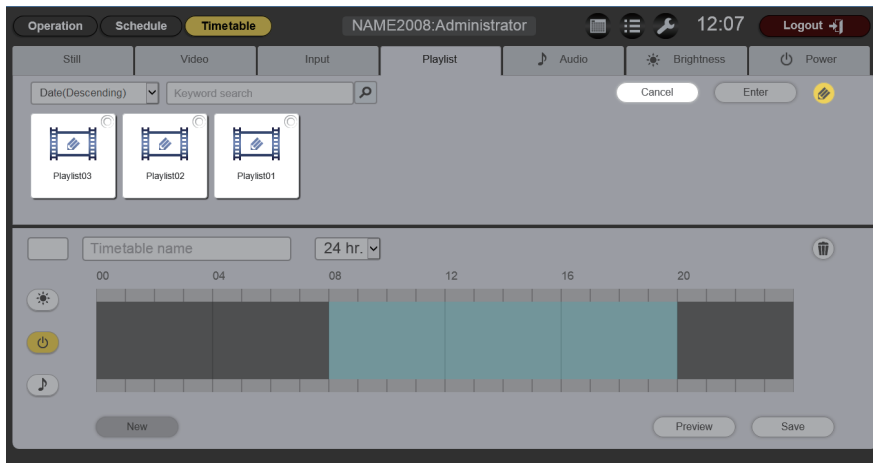

3) Select a playlist you want to edit, and click the [Execute] button.

- The [Playlist edit] screen is displayed.

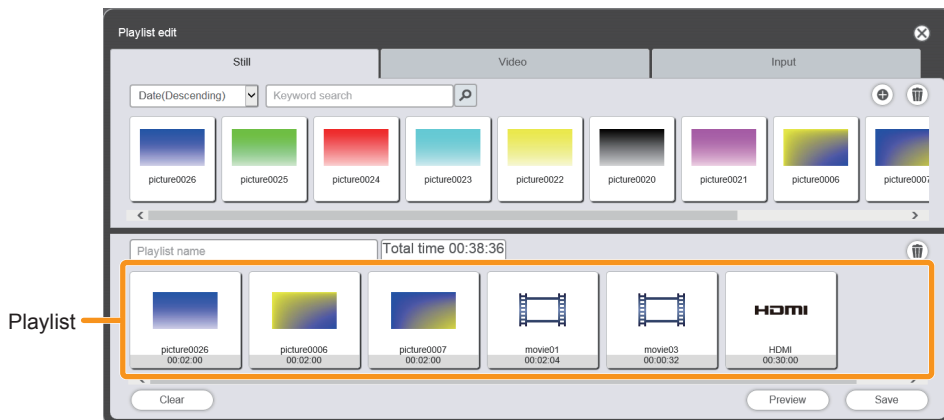

4) Editing a playlist

- To add content, perform the procedure same as “Registering playlist” (➔ page 149).
- To delete content, refer to “Deleting content registered in a playlist” (➔ page 153).
- To change content settings, refer to “Changing the settings of content registered in a playlist” (➔ page 153).

5) Click the [Save] button.

- The edited playlist is registered in the SD card.

Deleting content registered in a playlist

Delete the content registered in a playlist.



- 1) Click  on the [Playlist edit] screen.
 - The mode changes to selection mode.

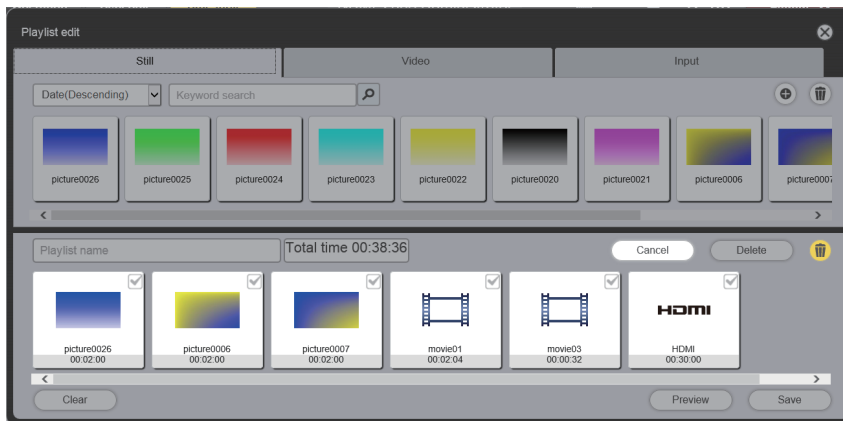

- 2) Select the content to delete.
 - You can select multiple contents.
- 3) Click the [Delete] button.
- 4) When the confirmation screen is displayed, click the [OK] button.
 - The selected content is deleted from the playlist.
 - Return to the [Playlist edit] screen and click the [Save] button to register the edited playlist in the SD card.

Changing the settings of content registered in a playlist

Change the settings of content registered in a playlist

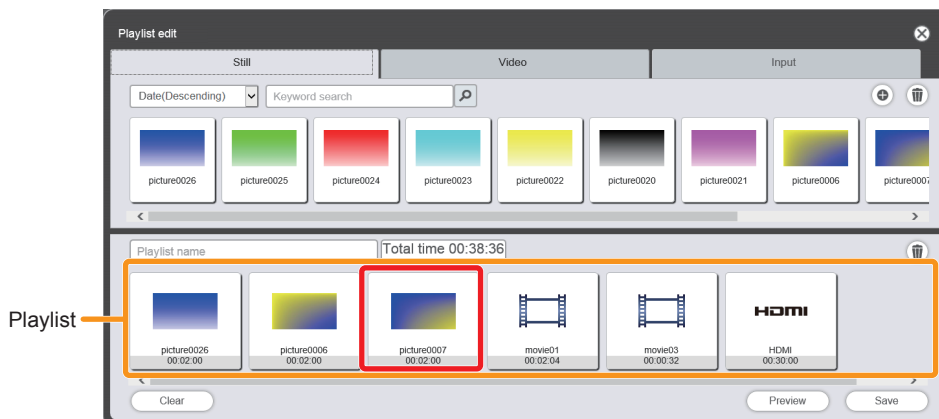

- 1) On the “playlist”, click the content of which setting you want to change.
 - The [Content edit] screen is displayed.

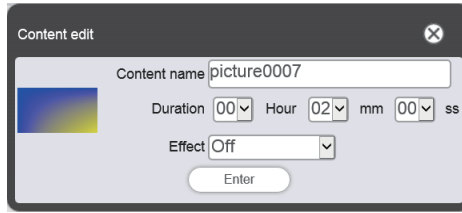

- 2) Change [Duration] and [Effect], and click the [Enter] button.
 - Change the playback time and image effect settings.
 - The settings of the content on the “playlist” will change.
 - You can set [Effect] only for still image content.
 - Return to the [Playlist edit] screen and click the [Save] button to register the edited playlist in the SD card.

Duplicating a playlist

Duplicate a registered playlist.

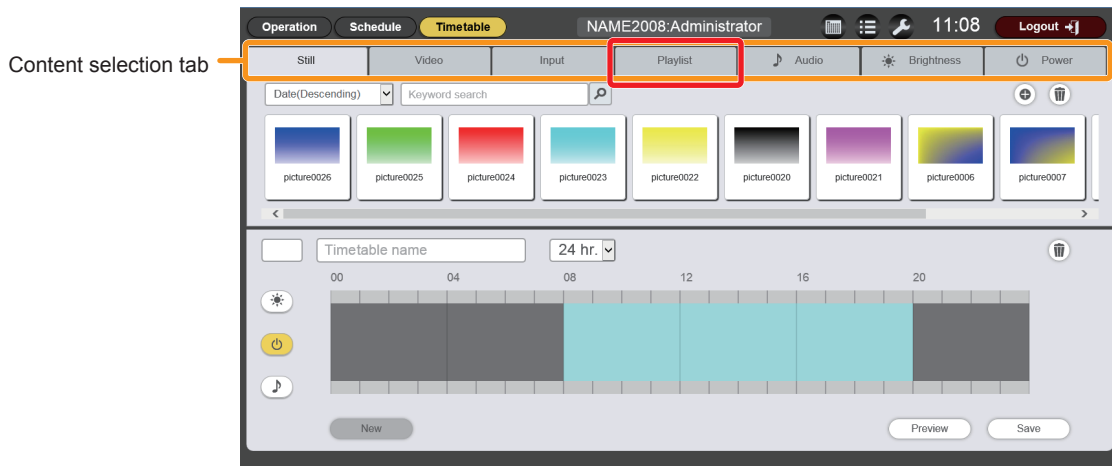

- 1) In the timetable page, click the [Playlist] tab among the “Content selection tab”.
 - The “Content list” shows the list of playlists.

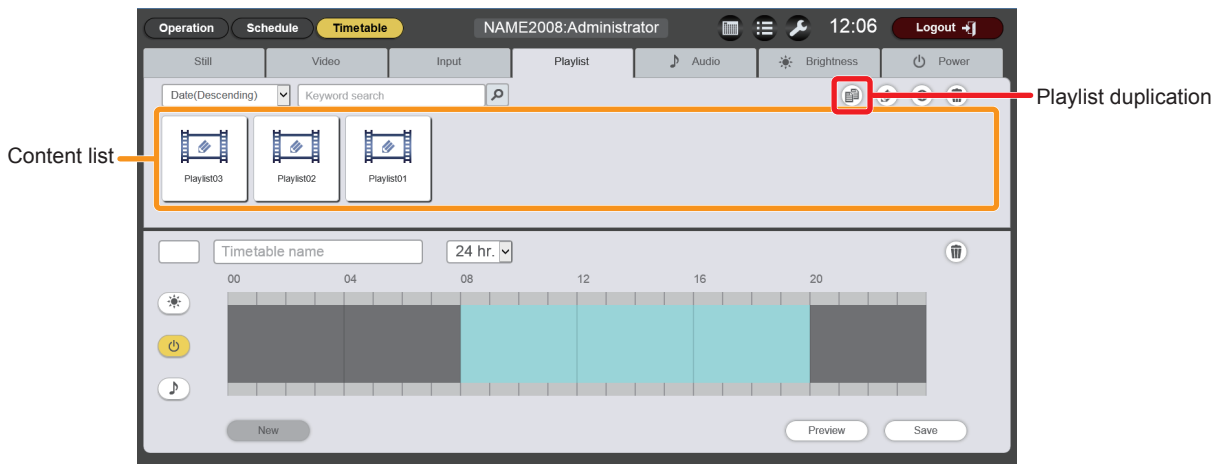

- 2) Click  in the “Content list”.
 - The mode changes to selection mode.

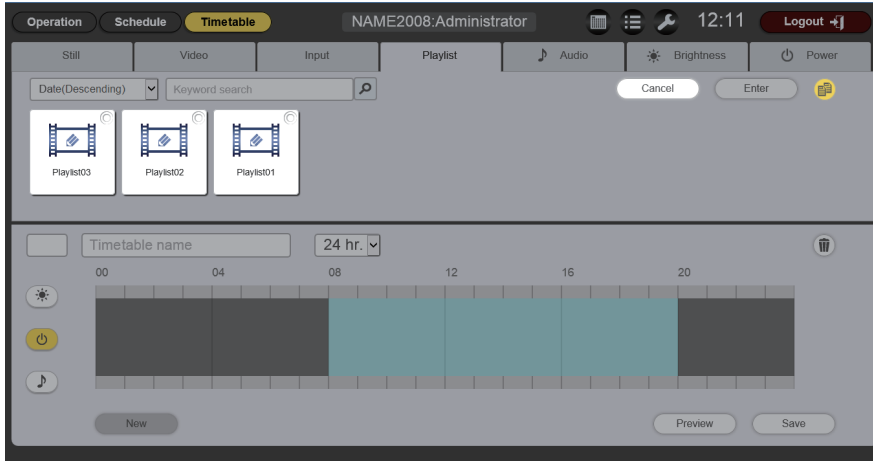

- 3) Select a playlist you want to duplicate, and click the [Execute] button.
 - The playlist name entry screen is displayed.

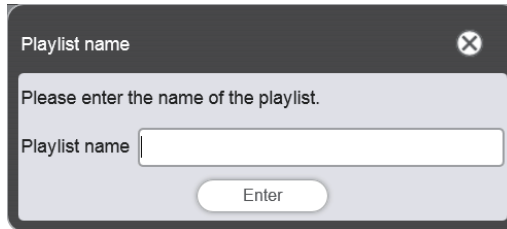

- 4) Enter any [Playlist name], and click the [Enter] button.
 - For [Playlist name], up to 24 characters in single byte can be input.
 - The duplicated playlist is displayed in the “Content list”, and registered in the SD card.

Displaying preview of playlist contents

Display the preview image of a playlist on the web browser or on the projection screen.

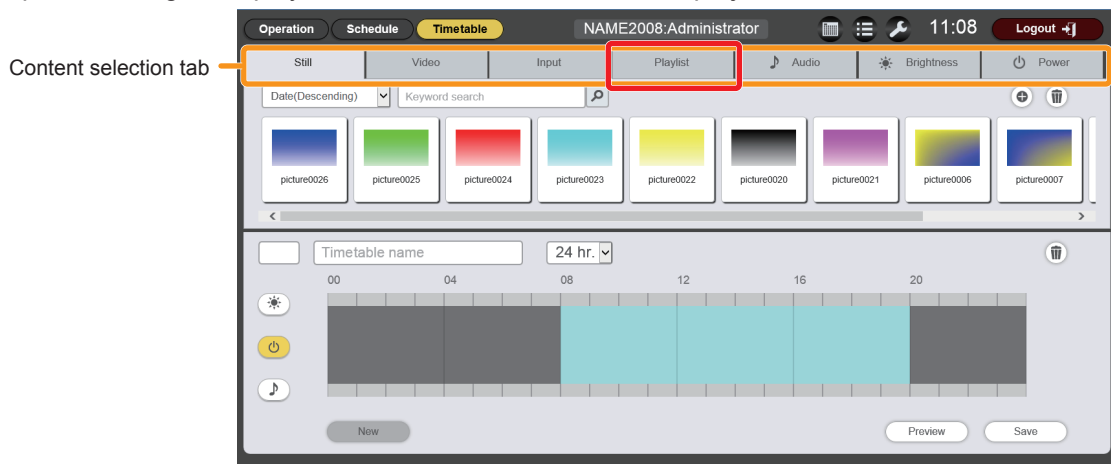

1) In the timetable page, click the [Playlist] tab among the “Content selection tab”.

- The “Content list” shows the list of playlists.

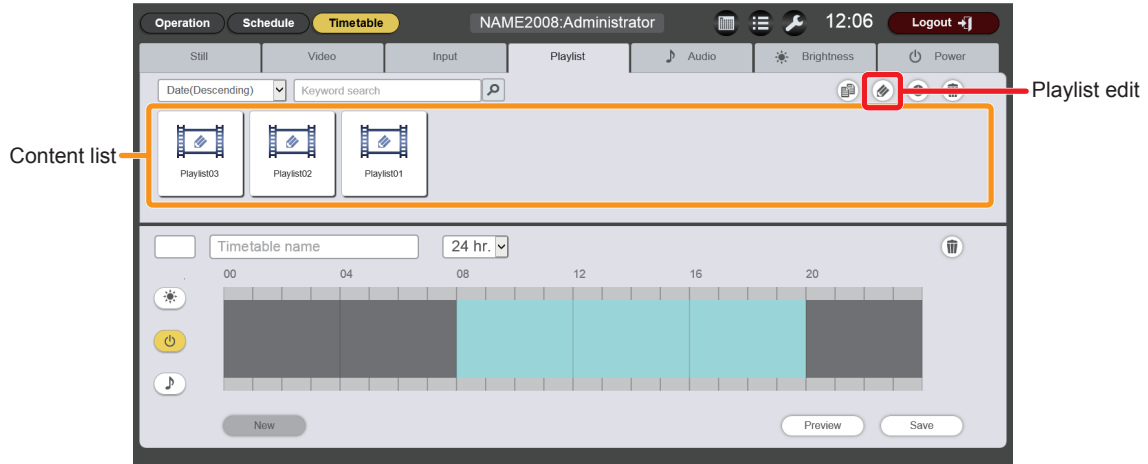

2) Click  in the “Content list”.

- The mode changes to selection mode.

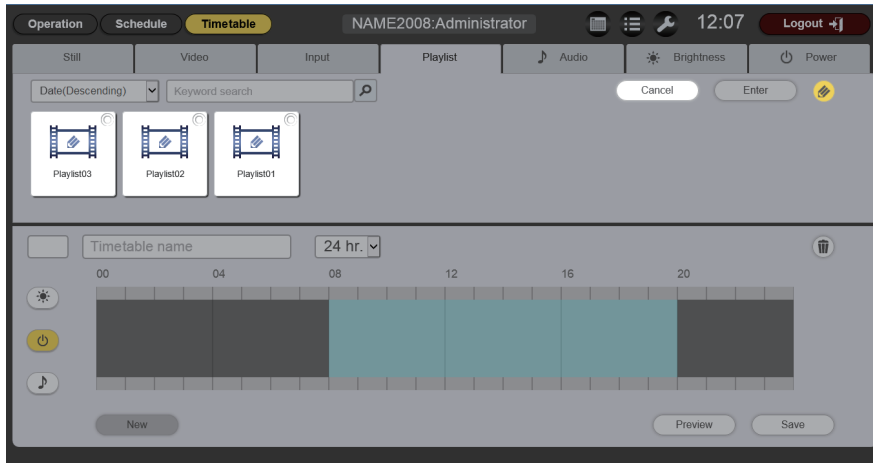

3) Select a playlist you want to preview, and click the [Execute] button.

- The [Playlist edit] screen is displayed.

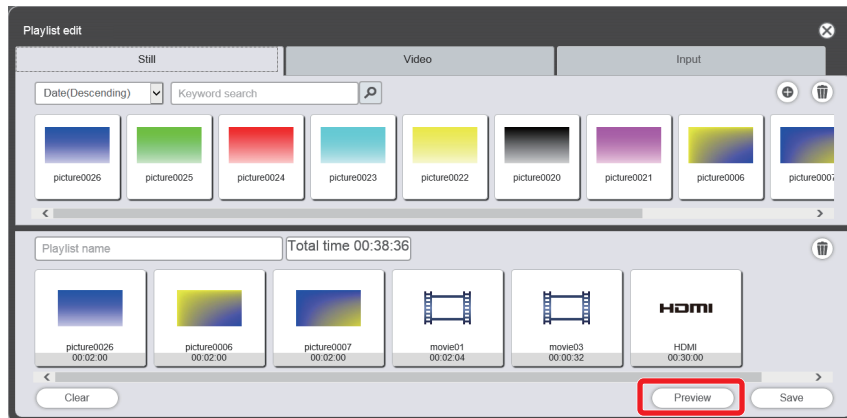

4) Click the [Preview] button.

- The preview mode selection screen is displayed.

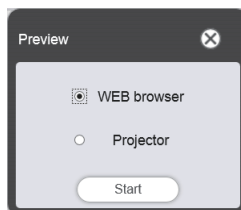

5) Select a preview mode, and click the [Start] button.

- When [WEB browser] is selected, the image is displayed on the web browser.
- When [Projector] is selected, the image is displayed on the projection screen.

Note

- In the following cases, the projector mode [Projector] is not available.
 - During signage playback (schedule/slideshow)
 - When the input is other than signage
 - When the projection mode is lighting mode

■ Preview mode [WEB browser]

- A preview screen like the following is displayed on the web browser.

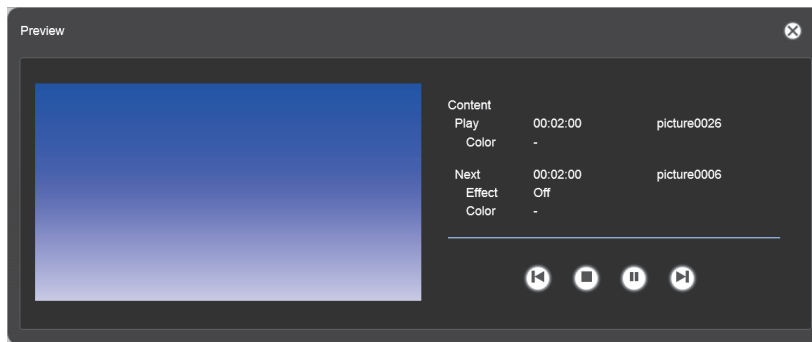

Operation icon	Performance
	Switches to the previous content.
	Stops playback.
	Starts or pauses playback. The icon display changes depending on the playback state.
	Switches to the next content.

Note

- When there is a blank period between contents, the period is handled as one content and displayed in preview.
- Regardless of the content setting, each content including blank periods is played for 10 seconds.
- In the case of movie/external input content, only an icon is displayed on the preview screen instead of the actual image.
- Image effects and color settings are not reflected in preview images.

■ Preview mode [Projector]

- Preview image is displayed on the projection screen.
- An operation screen like the following is displayed on the web browser.

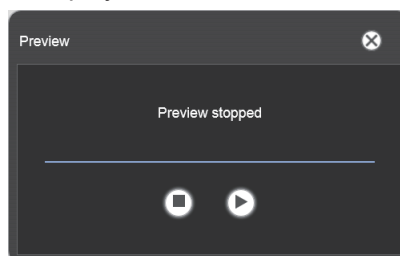

Operation icon	Performance
	Stops playback.
	Starts or pauses playback. The icon display changes depending on the playback state.

Note

- When there is a blank period between contents, the period is handled as one content and displayed in preview.

- Regardless of the content setting, still image content is played for 10 seconds, movie/external input content is played for 20 seconds, and blank period is played for 10 seconds.
- If paused during playback of still image content, or during a blank period between contents, the playback time of the content being paused is reset when it is resumed, and the content is played from the beginning. In the case of movie/external input content, the playback resumes from the paused part.

Setting a schedule

Set a daily schedule.

■ Schedule page

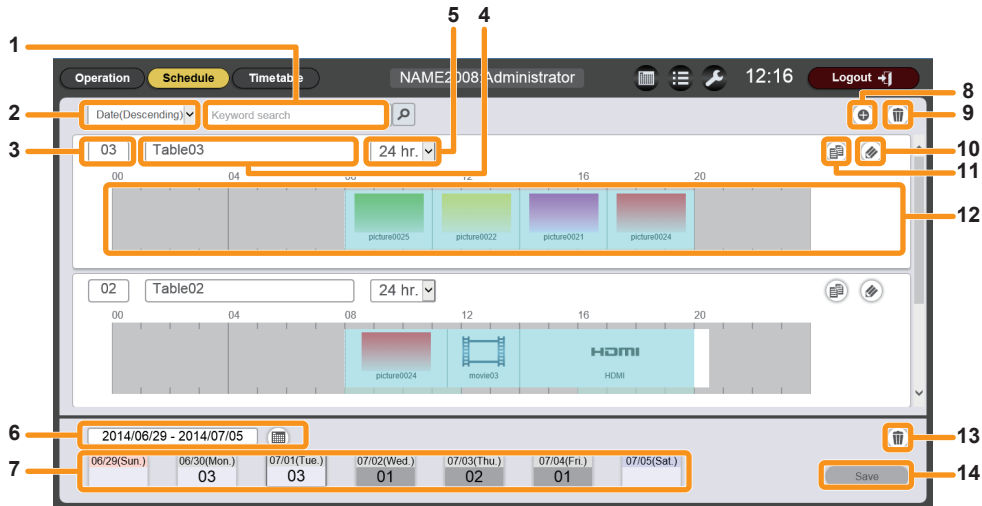

- [Keyword search]**
Enter string to be searched and click to search contents in the "PRIVATE" folder in the SD card.
- Sort timetable**
Sets the display order of timetables.
[Date(Ascending)]/[Date(Descending)]:
Displays timetables in the order of registration date.
[ID(Ascending)]/[ID(Descending)]:
Displays timetables in the order of timetable ID.
[Content name(Ascending)]/[Content name(Descending)]:
Displays timetables in the order of timetable name.
- Timetable ID**
Displays the timetable ID.
- Timetable name**
Displays the timetable name.
- Display scale**
Sets the display scale for "Timetable".
- Period setting**
Sets the period (week) to be displayed in a schedule.
When selected, the calendar is displayed.
- Schedule**
Displays the schedule of the specified week.
When selected, the assignment timetable display screen is displayed.
- Timetable addition icon**
Adds and registers a timetable in the SD card.
Click this to display the timetable page. ("Creating a timetable" (➡ page 133))
- Timetable deletion icon**
Deletes the timetable registered in the SD card. ("Deleting a timetable" (➡ page 164))
- Timetable edit icon**
Edits a registered timetable. ("Editing a timetable" (➡ page 163))
- Timetable duplication icon**
Duplicates a registered timetable. ("Duplicating a timetable" (➡ page 163))
- Timetable**
Displays the content registered in a timetable.
- Schedule deletion icon**
Deletes the timetable registered in a schedule. ("Deleting a schedule" (➡ page 162))
- [Save] button**
Registers the schedule currently displayed in the SD card.

■ Procedure for setting the schedule

1) On the start screen, click [Schedule].

- The schedule screen is displayed.
- Set necessary timetable (contents to be played back in a day) in advance. Refer to “Creating a timetable” (➔ page 133) for details. After the timetable is created, proceed to Step 2).

2) Click the [Schedule] button.

- The schedule page is displayed.
The following screen is an example when setting a schedule for the first time.

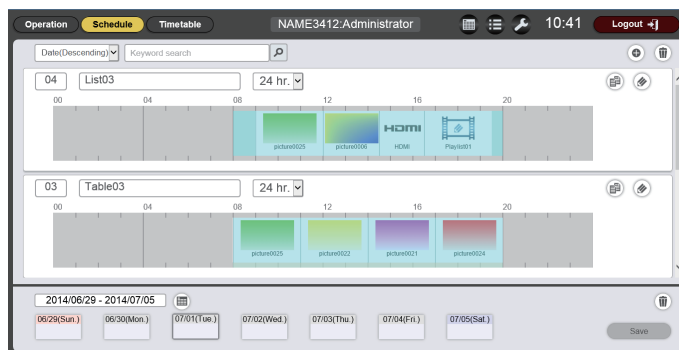

3) Select a day or day of the week to register the timetable.

- The timetable can be registered in a schedule by specifying the day when playing back different content on a daily basis, and by specifying a day of the week when repeating the same content on a weekly basis.

4) Register the timetable in a schedule.

- Select a timetable to be registered on the specified day or day of week and register it in a schedule. Refer to “Registering a schedule” (➔ page 160) for details.

5) Register the schedule.

- Click the [Save] button to set the schedule.

Note

- Schedules can be set from the current week up to 12 weeks ahead as the different timetable on a daily basis. The same content can also set on a weekly basis.
- For operations for setting the schedule, refer to the descriptions of the following items.
 - “Registering a schedule” (➔ page 160)
 - “Deleting a schedule” (➔ page 162)
 - “Editing a timetable” (➔ page 163)
 - “Duplicating a timetable” (➔ page 163)
 - “Deleting a timetable” (➔ page 164)
 - “Checking the contents of a timetable registered in a schedule” (➔ page 165)
- After the schedule is set, the schedule starts to be played back. Refer to “Starting playback of a schedule” (➔ page 166) for details.
- To check the schedule being played back, refer to “Checking the operational information of a schedule” (➔ page 165) to display the operational information page.
- To play back another content while the schedule is played back, refer to “Setting interruption playback” (➔ page 167).

Registering a schedule

Register schedules for the current week up to 12 weeks ahead.

■ Schedule page

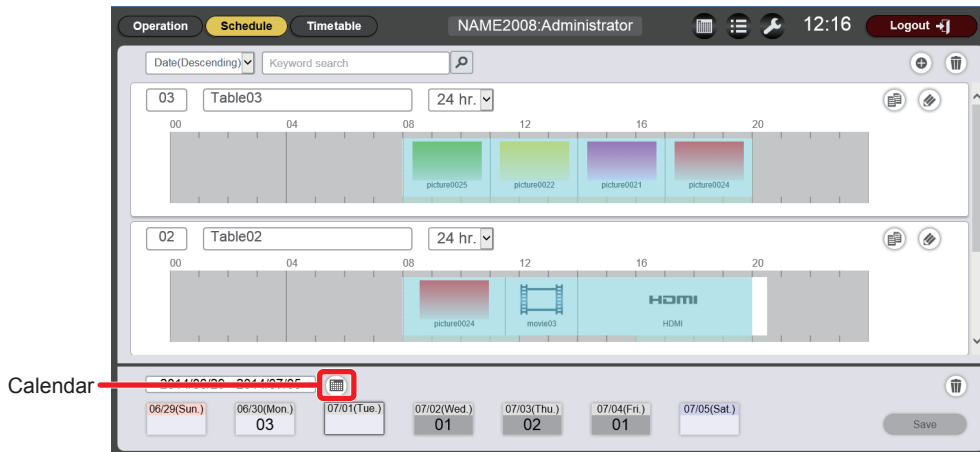

■ Calendar

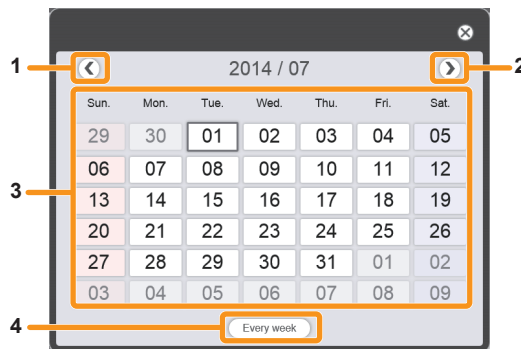

- 1 **Move to the previous month**
Displays the calendar of the previous month.
- 2 **Move to the next month**
Displays the calendar of the next month.
- 3 **Calendar**
Click a date to display the schedule of the week.
- 4 **[Every week] button**
Click this to register a timetable for a certain day of the week.

■ Procedure

- 1) Click for the "Period setting".
 - The calendar is displayed.
- 2) On the calendar, click the day in which you want to register a timetable.
 - The "Period setting" and "Schedule" are updated.

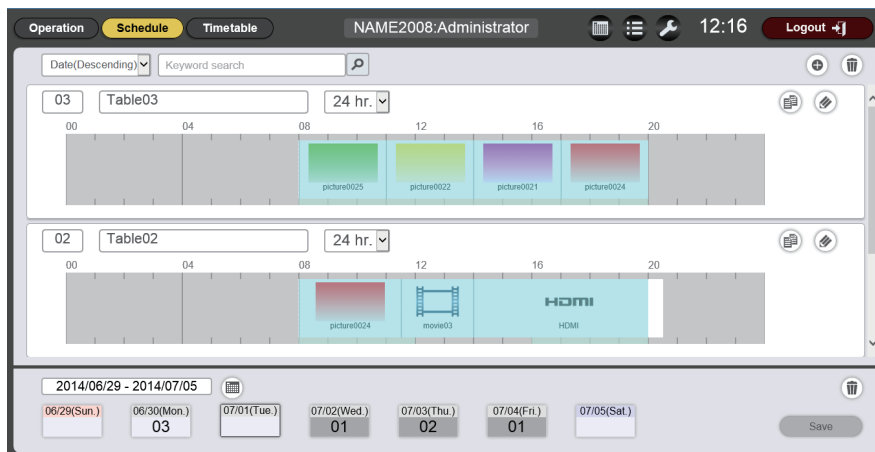

- When you click the [Every week] button, the “schedule” for day of the week is displayed. You can set the same timetable for a certain day of the week every week. In this case, the period in which the schedule can be registered is not restricted.

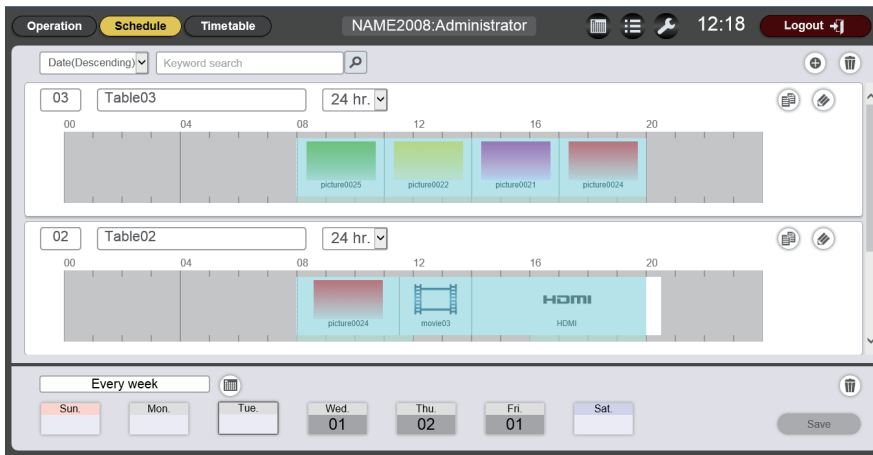

3) Select a timetable, and register the timetable ID in the schedule.

- Drag and drop the “Timetable ID” in the day or day of the week on the “Schedule”.

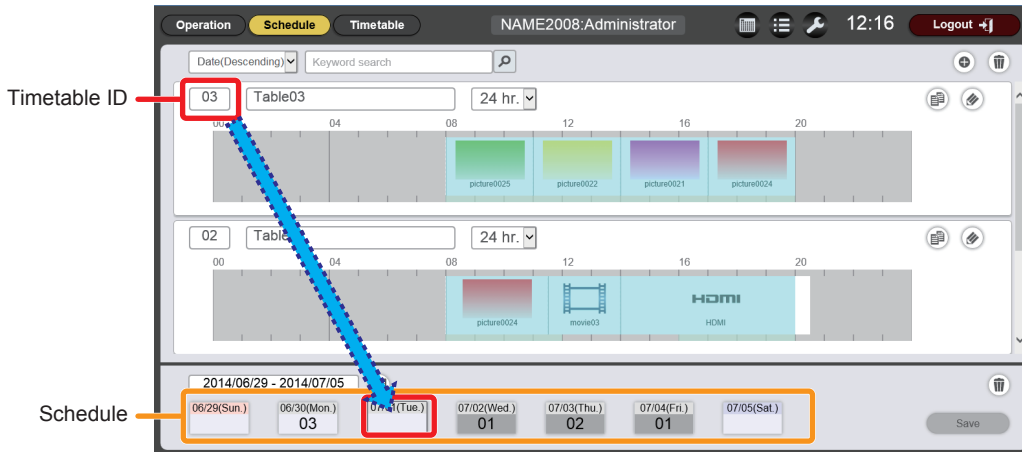

- When you finish registering the timetable in the schedule currently displayed, proceed to Step 4).

4) After the registration of the timetable is complete, click the [Save] button.

- The schedule is registered in the SD card.

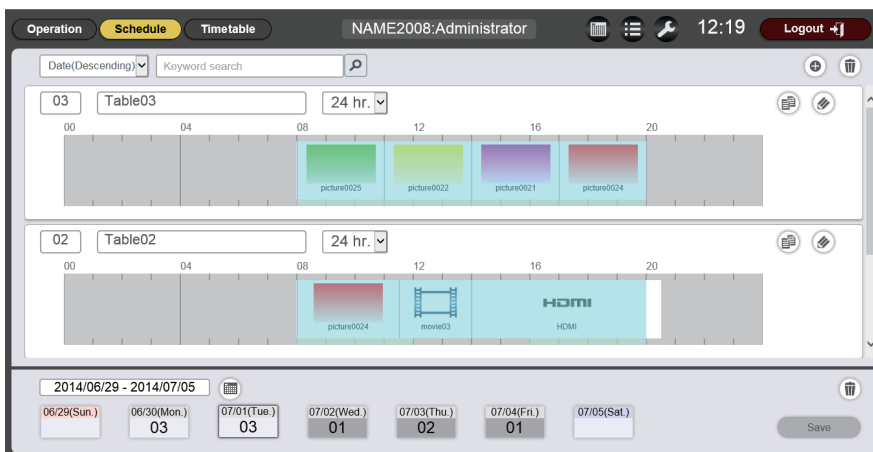

Note

- When you use Internet Explorer as the web browser, and drag the “Timetable ID” with the mouse pointer, the ID sometimes does not follow the mouse pointer properly depending on the set window size. In that case, drag the “Timetable ID” and drop the mouse pointer over the day or day of week where you want to register the ID on the “Schedule”.

Deleting a schedule

Delete an unnecessary schedule.

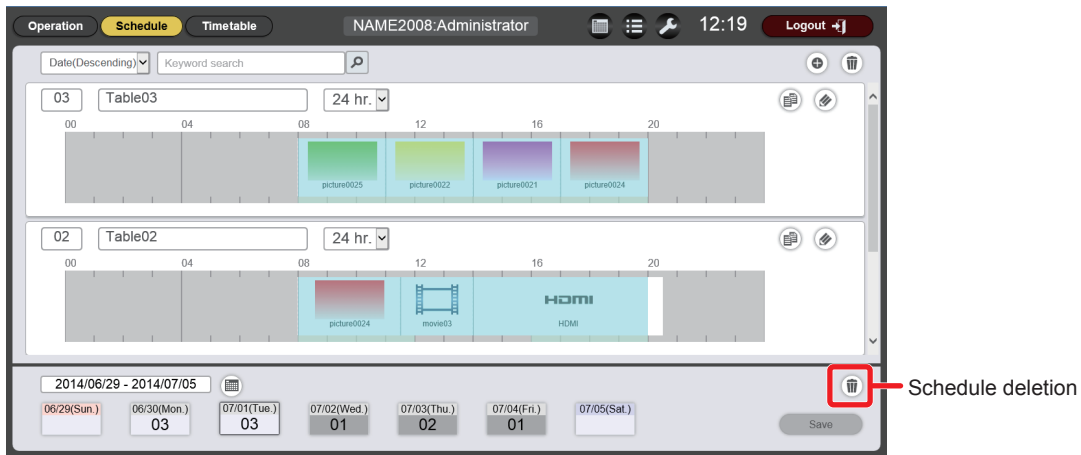

1) Click .

- The mode changes to deletion mode.



2) Select a day or day of week to delete.

- You can select multiple days or days of week.

3) Click the [Delete] button.

4) When the confirmation screen is displayed, click the [OK] button.

- The timetable assigned to the selected day or day of week is deleted from the schedule.

Note

- Deleting a timetable from the schedule will not delete the timetable from the SD card.

Editing a timetable

Change the contents to be played back in a day and the playback sequence and playback time registered in a timetable.

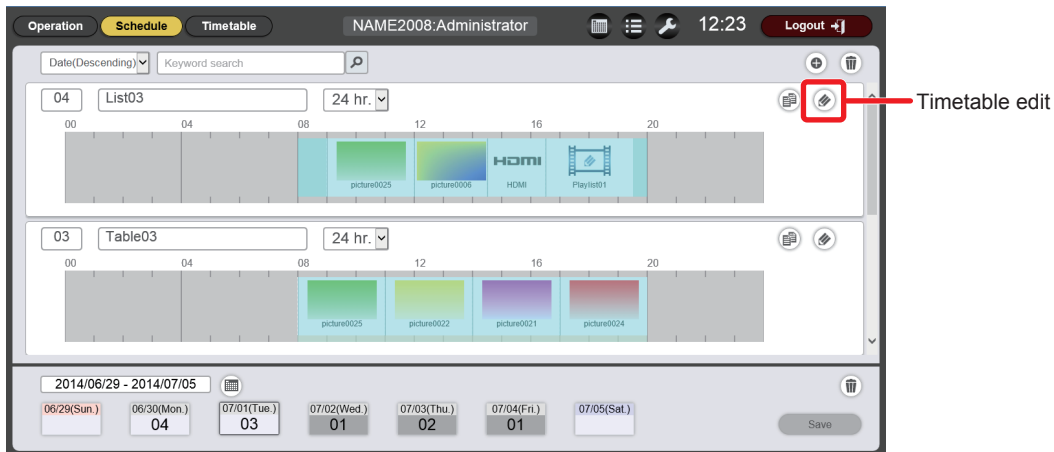

- 1) Click  of the timetable to edit.
 - The timetable page is displayed.

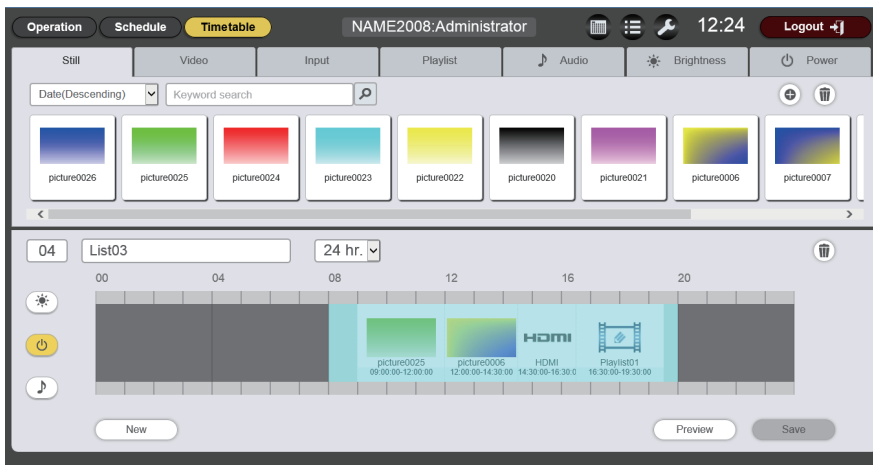

- 2) Edit the timetable.
 - Edit the timetable according to the procedure described in “Creating a timetable” (➔ page 133).

Duplicating a timetable

Duplicate a registered timetable.

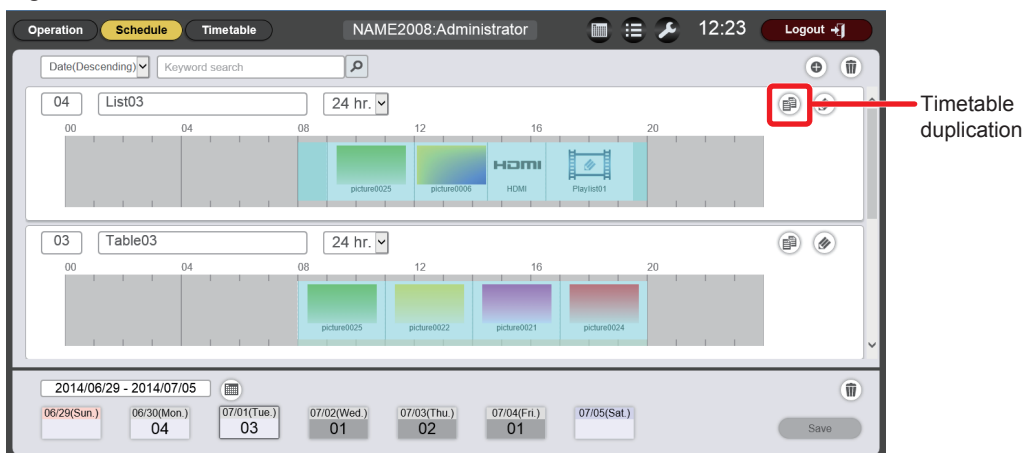

- 1) Click  of the timetable to duplicate.
 - The timetable name entry screen is displayed.



- 2) Enter the timetable name, and click the [Enter] button.
 - The timetable is duplicated.

Deleting a timetable

Delete a registered timetable.

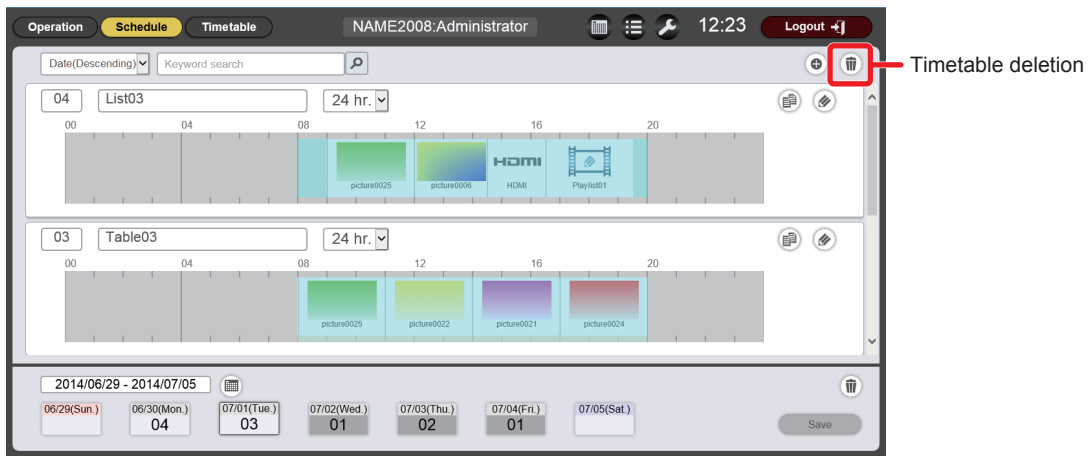

- 1) Click .
 - The mode changes to deletion mode.

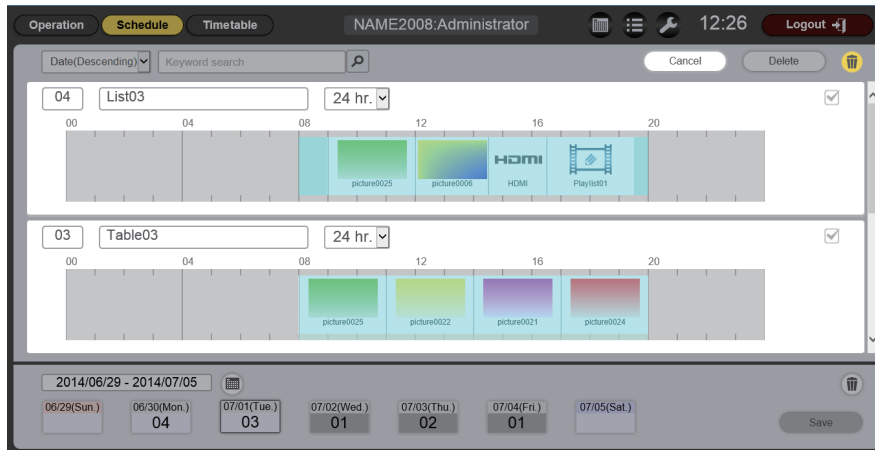

- 2) Select the timetable to delete.
 - You can select multiple timetables.
- 3) Click the [Delete] button.
- 4) When the confirmation screen is displayed, click the [OK] button.
 - The selected timetable is deleted from the SD card.

Note

- If the timetable to be deleted is registered in a schedule, then the timetable cannot be deleted.

Checking the contents of a timetable registered in a schedule

Display the contents of a timetable assigned to the schedule you want to check.

■ Schedule page

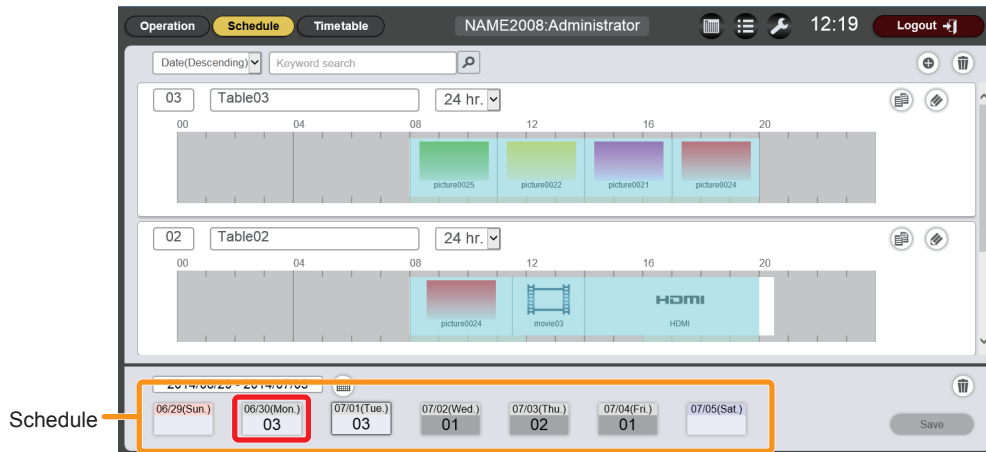

■ [Assigned timetable] screen

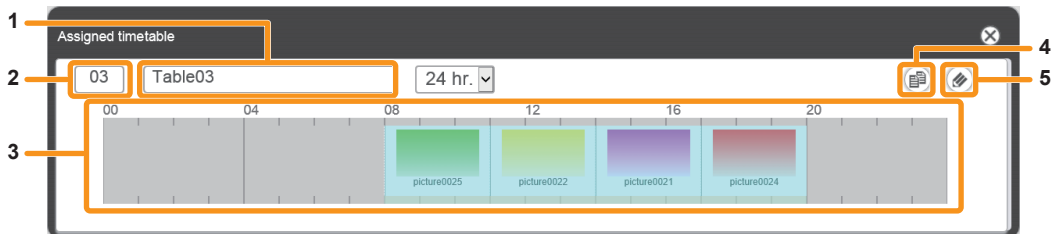

- 1 **Timetable name**
Displays the timetable name.
- 2 **Timetable ID**
Displays the timetable ID.
- 3 **Timetable**
Displays the content registered in a timetable.
- 4 **Timetable duplication icon**
Duplicates the timetable being displayed. ("Duplicating a timetable" (➔ page 163))
- 5 **Timetable edit icon**
Edits the timetable being displayed. ("Editing a timetable" (➔ page 163))

■ Procedure

- 1) Click the day or day of week of which timetable you want to confirm the details.
 - The [Assigned timetable] screen is displayed.

Checking the operational information of a schedule

Check the information of the content currently played or check the assigned schedule.

■ Operational information page

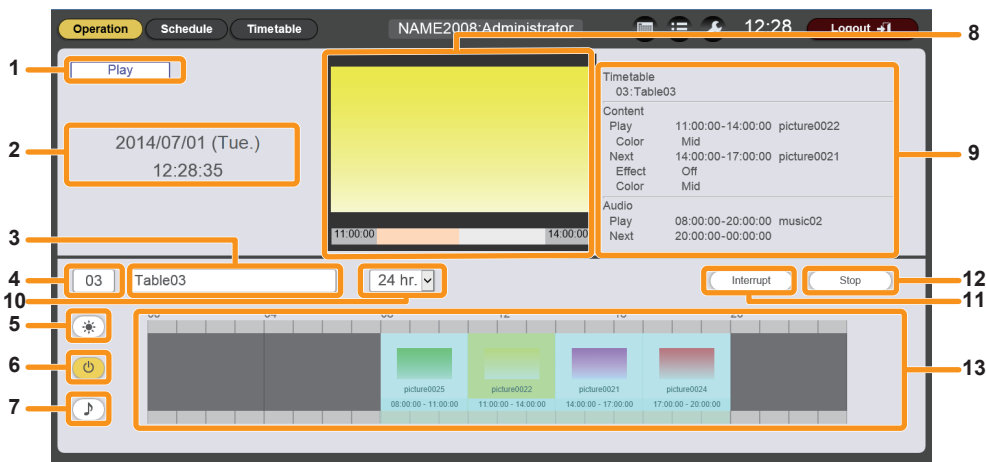

- 1 **Playback status**
Displays the status of signage playback (schedule/slideshow).
- 2 **Projector date and time**
Displays the date and time of the connected projector.
- 3 **Timetable name**
Displays the name of the timetable currently assigned.
- 4 **Timetable ID**
Displays the ID of the timetable currently assigned.
Click the ID to display the timetable page. (“Creating a timetable” (➔ page 133))
- 5 **Brightness content display icon**
Click this to display the brightness content for changing brightness of the light source registered in the timetable.
- 6 **Power supply content display icon**
Click this to display the power supply content for turning off/on of the power source registered in the timetable.
- 7 **Music content display icon**
Click this to display the music content to play music files registered in the timetable.
- 8 **Playback screen**
Displays the still image/movie/external input content being played.
Movie/external input content is displayed as an icon.
- 9 **Playback information**
Displays the information of still image/movie/external input/music content being played.
- 10 **Display scale**
Sets the display scale for “Timetable”.
- 11 **[Interrupt] button**
Click this to display the [Interrupt list] screen. (“Setting interruption playback” (➔ page 167))
- 12 **[Play]/[Stop] button**
Click this to start playing a schedule, or to stop playing the schedule. (“Starting playback of a schedule” (➔ page 166))
- 13 **Timetable**
Displays the timetable currently assigned.

■ Procedure

- 1) **On the start screen, click [Schedule].**
 - The schedule screen is displayed.
- 2) **Click the [Operation] button.**
 - The operational information page is displayed.

Starting playback of a schedule

Play a schedule in the operational information page.

- 1) **On the start screen, click [Schedule].**
 - The schedule screen is displayed.
- 2) **Click the [Operation] button.**
 - The operational information page is displayed.

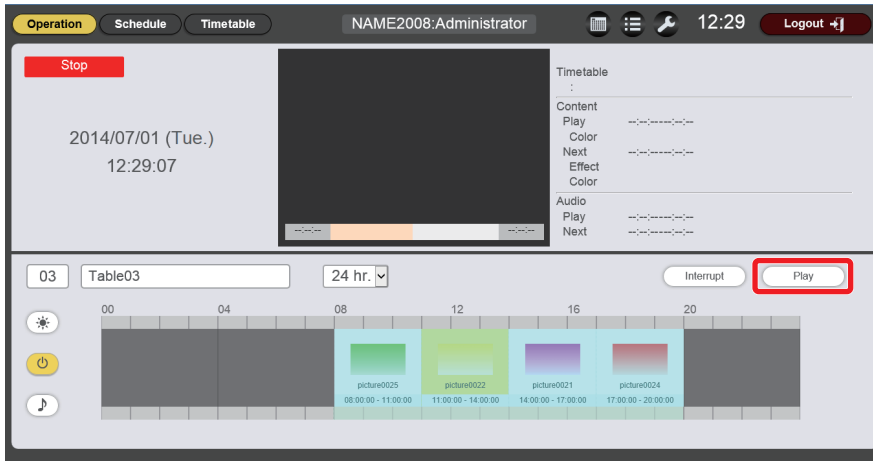

- 3) **Click the [Play] button.**
 - The input of the projector automatically switches to signage, and playback starts according to the registered schedule.
 - The [Play] button changes to the [Stop] button.
 - To stop playback of the schedule, click the [Stop] button.

Setting interruption playback

Register the setting of content to be played back interrupting signage playback (schedule/slideshow) or play back the content.

■ [Interrupt list] screen

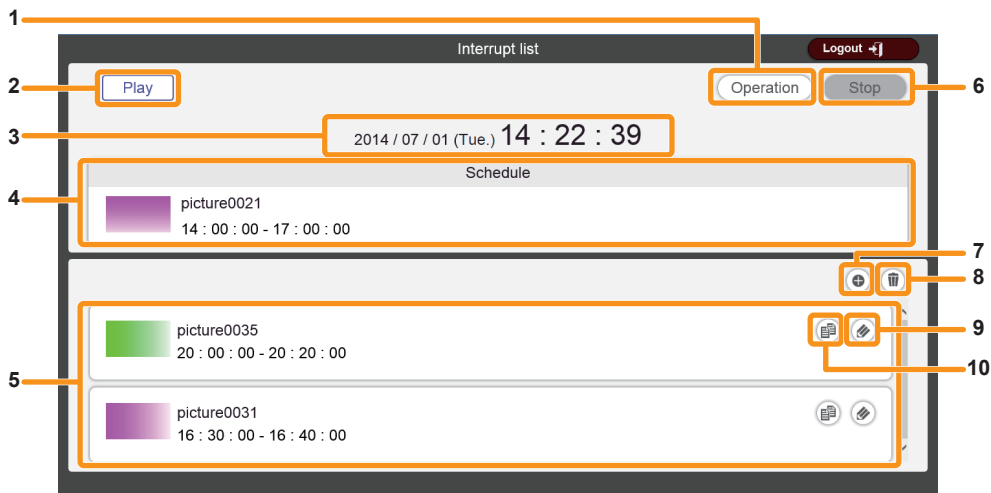

1 [Operation] button

Click this to return to the operational information page.

2 Playback status

Displays the status of signage playback (schedule/slideshow).

3 Projector date and time

Displays the date and time of the connected projector.

4 Playback content

Displays the still image/movie/external input content being played.

Movie/external input content is displayed as an icon.

5 Interruption schedule

Displays registered interruption schedules.

6 [Stop] button

Click this to stop interruption playback. ("Canceling the currently played interruption schedule" (➡ page 173))

7 Interruption schedule registration icon

Register a new interruption schedule. ("Registering interruption playback" (➡ page 168))

8 Registered interruption schedule deletion icon

Deletes a registered interruption schedule. ("Deleting a registered interruption schedule" (➡ page 171))

9 Registered interruption schedule edit icon

Edit a registered interruption schedule. ("Editing the information of registered interruption schedule" (➡ page 170))

10 Registered interruption schedule duplication icon

Duplicates a registered interruption schedule. ("Duplicating a registered interruption schedule" (➡ page 171))

■ Procedure for registering interruption playback

1) On the start screen, click [Schedule].

- The schedule screen is displayed.

2) Click the [Operation] button.

- The operational information page is displayed.

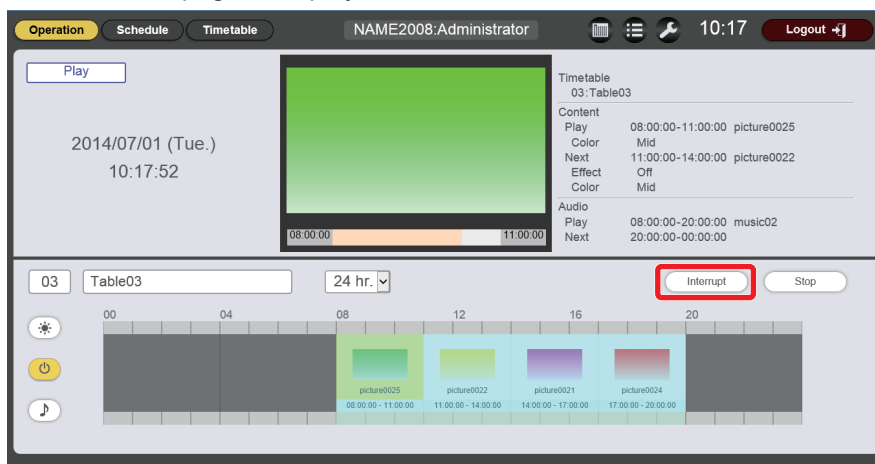

3) Click the [Interrupt] button.

- The [Interrupt list] screen is displayed.

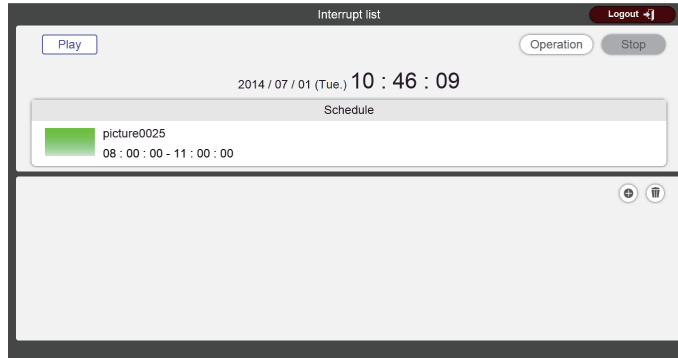

4) Register the content for interruption playback and the playback schedule.

- Register the still image content to be played back interrupting signage playback (schedule/slideshow) and set the schedule for interruption playback. Refer to “Registering interruption playback” (➔ page 168) for details.

Note

- You can register only still image files in interruption playback.
- After interruption playback, the interruption schedule remains registered. When [Time of change-of-day] (“Setting a schedule” (➔ page 176)) set in the [System setting] page has passed, it is deleted from the interruption schedule.
- For operations for interruption playback, refer to the descriptions of the following items.
 - “Registering interruption playback” (➔ page 168)
 - “Editing the information of registered interruption schedule” (➔ page 170)
 - “Duplicating a registered interruption schedule” (➔ page 171)
 - “Deleting a registered interruption schedule” (➔ page 171)
 - “Editing the information of currently played interruption schedule” (➔ page 172)
 - “Canceling the currently played interruption schedule” (➔ page 173)

Registering interruption playback

Register interruption playback to play still image content interrupting signage playback (schedule/slideshow).

■ [Interrupt list] screen

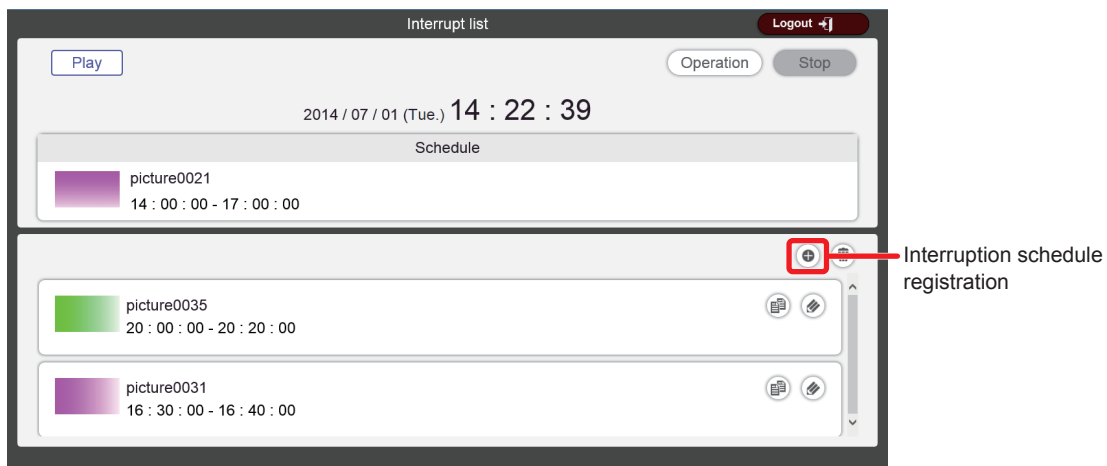

■ [Interrupt registration] screen

This is the screen displayed after selecting still image content to be used for interruption playback.

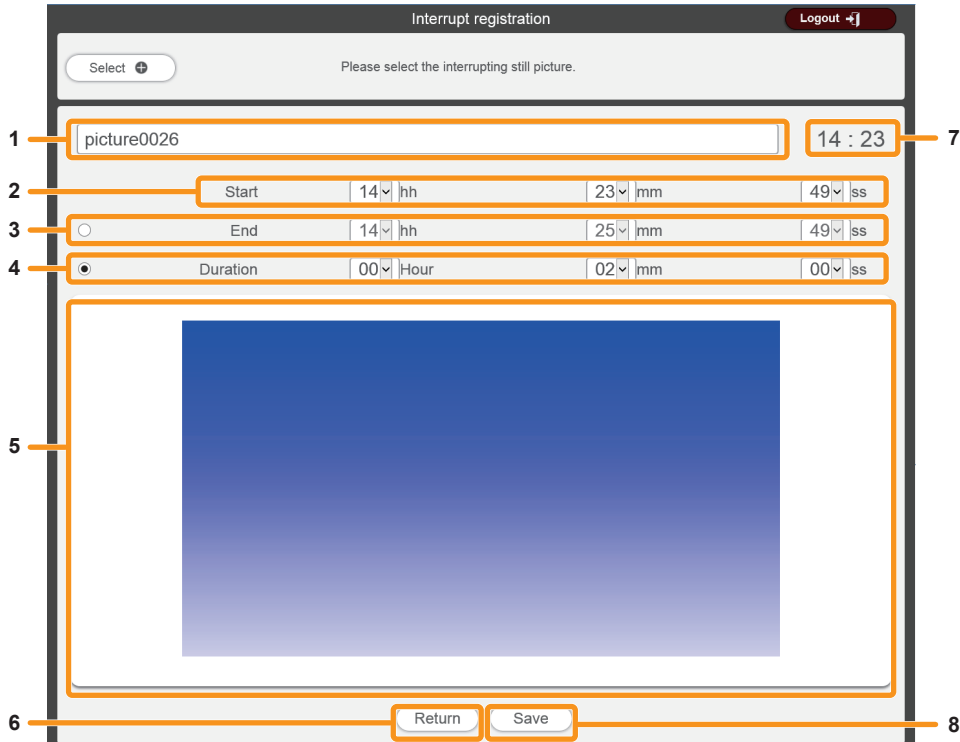

- | | |
|---|--|
| <p>1 Interrupted still image content name
Enter the interrupted still image content name.</p> <p>2 [Start]
Sets the time to start interruption playback.</p> <p>3 [End]
Select the radio button, and set the time to end the interruption playback.</p> <p>4 [Duration]
Select the radio button, and set the time to start the interruption playback.</p> | <p>5 Interrupted still image content being selected
Displays the selected still image content.</p> <p>6 [Return] button
Click this to return to the [Interrupt list] screen.</p> <p>7 Projector time
Displays the time of the connected projector.</p> <p>8 [Save] button
Click this to confirm the settings, and register the interruption schedule in the SD card.</p> |
|---|--|

■ Procedure

- 1) Click .
- The [Interrupt registration] screen is displayed.

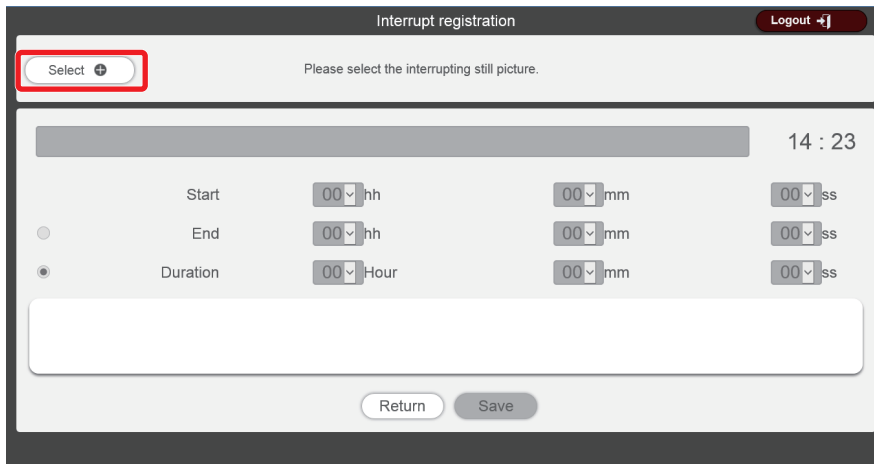

- 2) Click the [Select] button.
- The file selection screen is displayed.
- 3) Select still image content used for interruption playback (one file at a time), and click the [Open] button.
- The [Interrupt registration] screen display is updated.

- 4) Enter the interrupted still image content name, [Start], and [End] or [Duration].
 - For an interrupted still image content name, up to 24 characters in single byte can be entered.
- 5) Click the [Save] button.
 - It is registered in the interruption schedule.
 - The selected still image content is registered in the SD card.

Note

- You can register only still image files in interruption playback.
- If the playback time overlaps the existing registered interruption schedule, then the interruption cannot be saved.
- It is possible to start interruption playback during playback of a slideshow.

Editing the information of registered interruption schedule

Edit the playback time of a registered interruption schedule.

■ [Interrupt list] screen

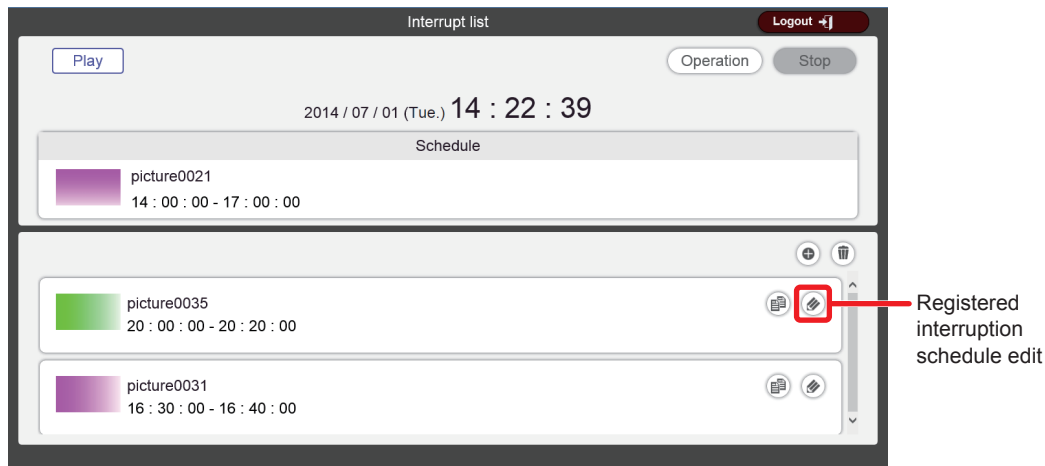

■ [Interrupt edit] screen

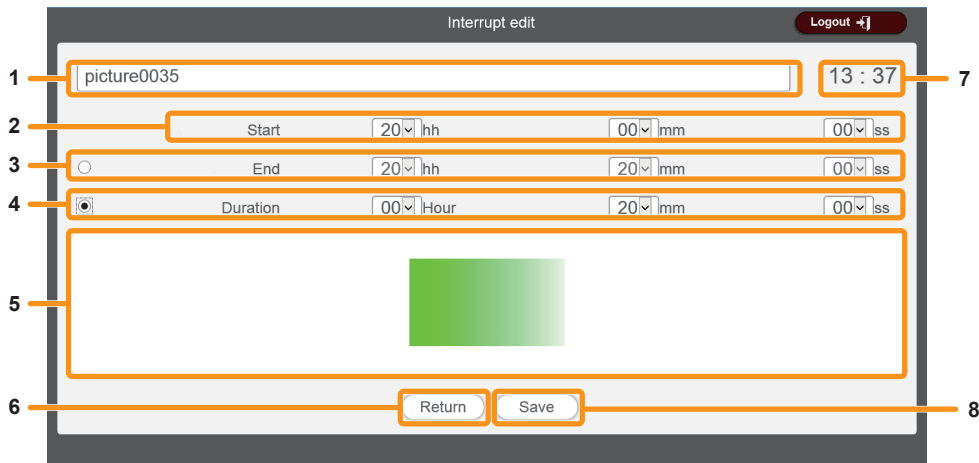

- | | |
|--|---|
| <ol style="list-style-type: none"> 1 Interrupted still image content name
Displays the selected interrupted still image content name. 2 [Start]
Sets the time to start interruption playback. 3 [End]
Select the radio button, and set the time to end the interruption playback. 4 [Duration]
Select the radio button, and set the time to start the interruption playback. | <ol style="list-style-type: none"> 5 Interrupted still image content being edited
Displays the selected still image content. 6 [Return] button
Click this to return to the [Interrupt list] screen. 7 Projector time
Displays the time of the connected projector. 8 [Save] button
Click this to confirm the settings, and register the interruption schedule in the SD card. |
|--|---|

■ Procedure

- 1) Click  of the registered interruption schedule to be edited.
 - The [Interrupt edit] screen is displayed.

- 2) Edit [Start], and [End] or [Duration].
- 3) Click the [Save] button.
 - The edited interruption schedule is registered by overwrite.

Note

- Interrupted still image content name cannot be edited.
- If the playback time overlaps the existing registered interruption schedule, then the interruption cannot be saved.

Duplicating a registered interruption schedule

Duplicate a registered interruption schedule.

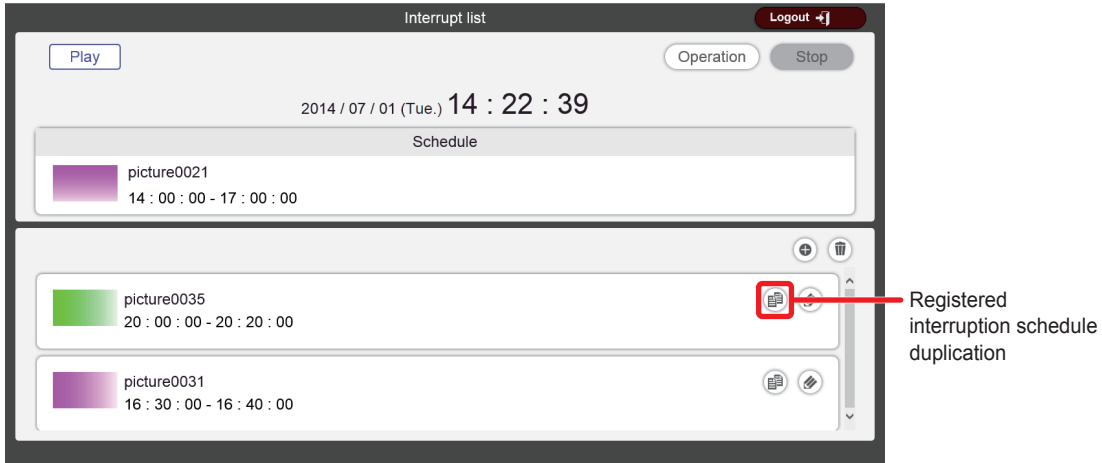

- 1) Click  of the registered interruption schedule to be duplicated.
 - The [Interrupt edit] screen is displayed.
- 2) Edit [Start], and [End] or [Duration].
- 3) Click the [Save] button.
 - The interruption schedule is duplicated, and registered in the SD card.

Note

- Interrupted still image content name cannot be edited.
- If the playback time overlaps the existing registered interruption schedule, then the interruption cannot be saved.

Deleting a registered interruption schedule

Delete a registered interruption schedule.

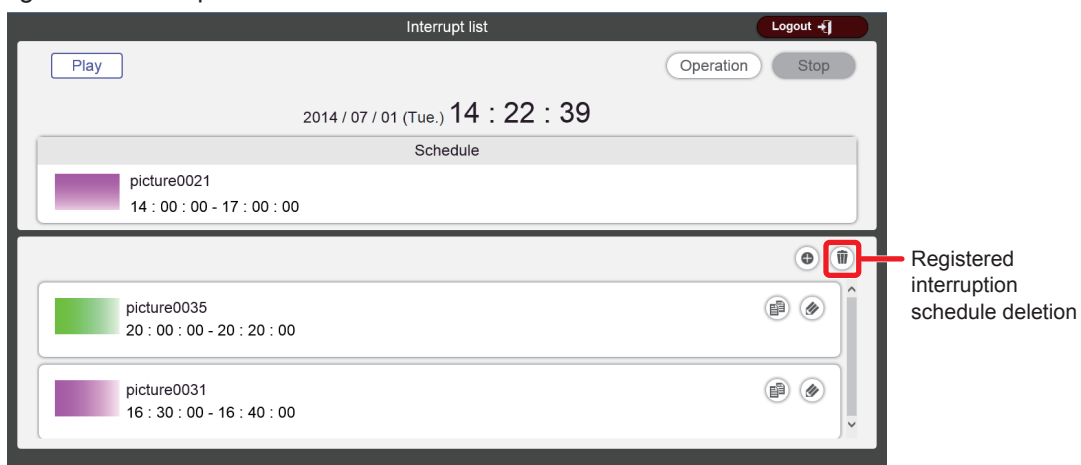

1) Click  of the registered interruption schedule to be deleted.

- The mode changes to deletion mode.

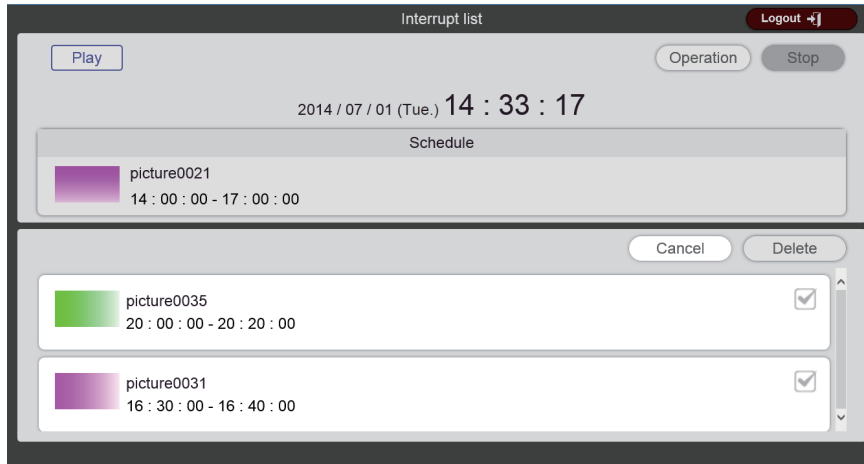

2) Select the interruption schedule to be deleted.

- You can select multiple interruption schedules.

3) Click the [Delete] button.

4) When the confirmation screen is displayed, click the [OK] button.

- The selected interruption schedule is deleted.

Note

- Deleting the interruption schedule will not delete the still image content from the SD card.

Editing the information of currently played interruption schedule

Edit the playback time of the currently played interruption schedule.

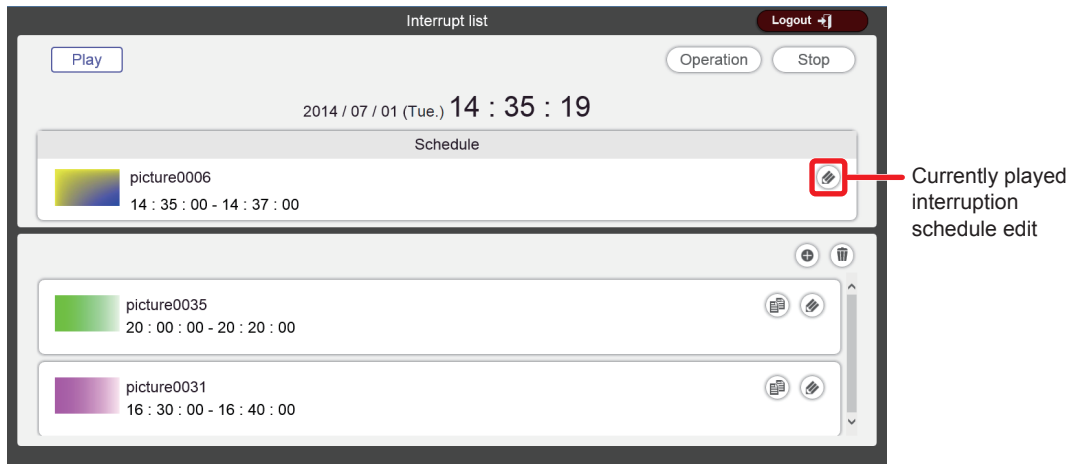

1) Click .

- The [Interrupt edit] screen is displayed.

2) Edit [Start], and [End] or [Duration].

3) Click the [Save] button.

- The edited interruption schedule is registered by overwrite.

Canceling the currently played interruption schedule

Stop the current interruption playback and terminate the interruption schedule. You can use this function when you set the wrong timing to start interruption playback or set the wrong content, or when interruption playback is no longer necessary in the middle of the interruption playback.

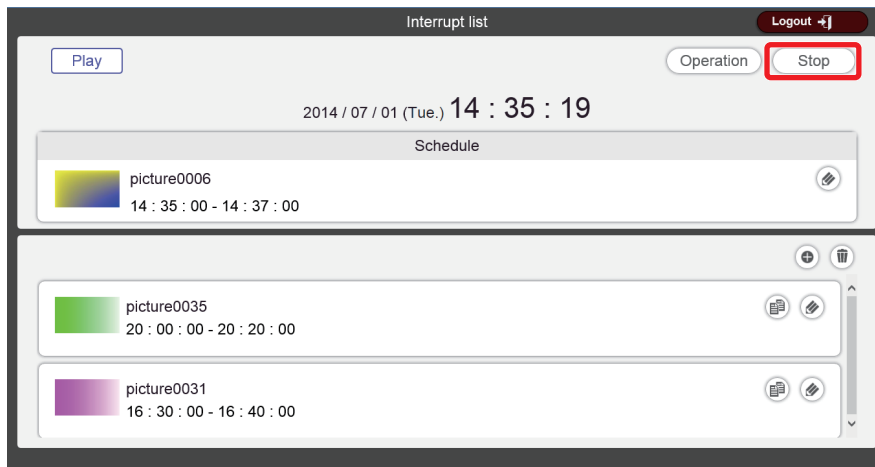

1) Click the [Stop] button.

- Interrupt the currently played interruption schedule and terminate the interruption playback.

Checking a schedule

Check the currently registered schedule.

■ Schedule confirmation screen

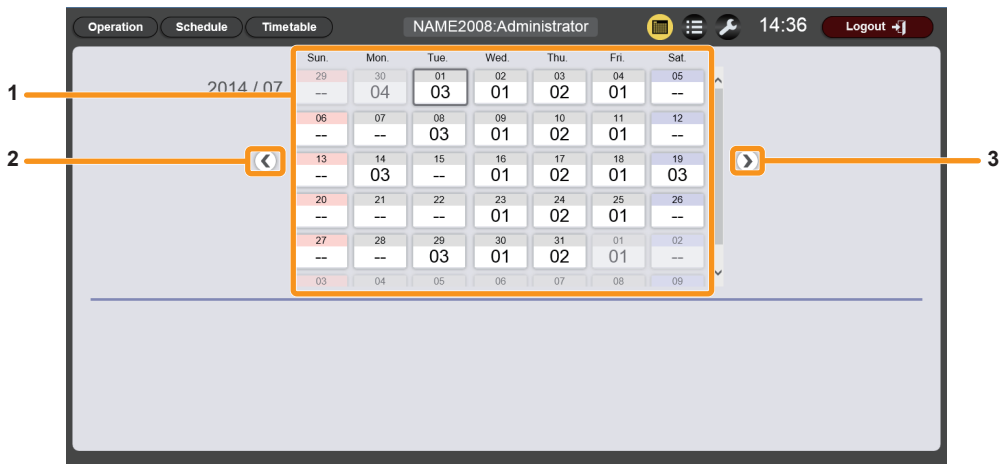

1 Calendar

Displays the ID of the assigned timetable for each date. Click an ID to display the timetable of the day.

2 Move to the previous month

Displays the calendar of the previous month.

3 Move to the next month

Displays the calendar of the next month.

■ Schedule confirmation screen (timetable update)

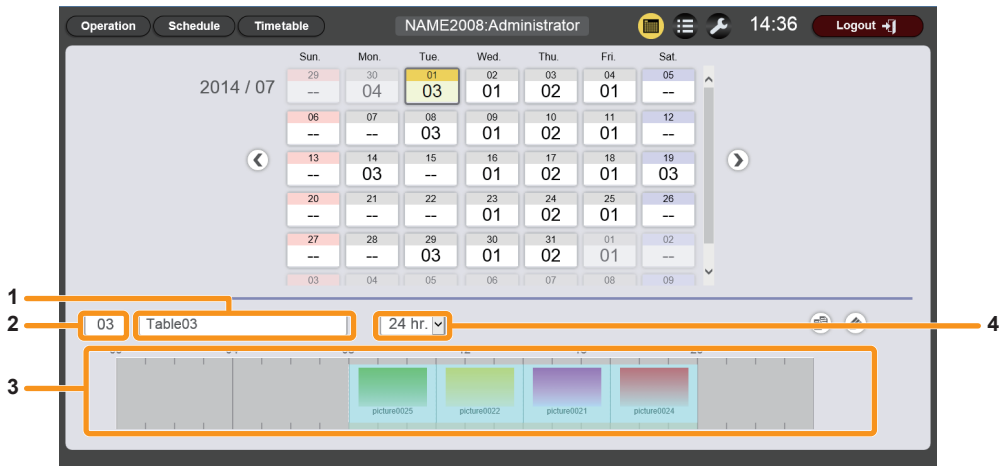

- 1 **Timetable name**
Displays the timetable name.
- 2 **Timetable ID**
Displays the timetable ID.
- 3 **Timetable**
Displays the content registered in the timetable of the selected day.
- 4 **Display scale**
Sets the display scale for "Timetable".

■ Procedure

- 1) **On the start screen, click [Schedule].**
 - The schedule screen is displayed.

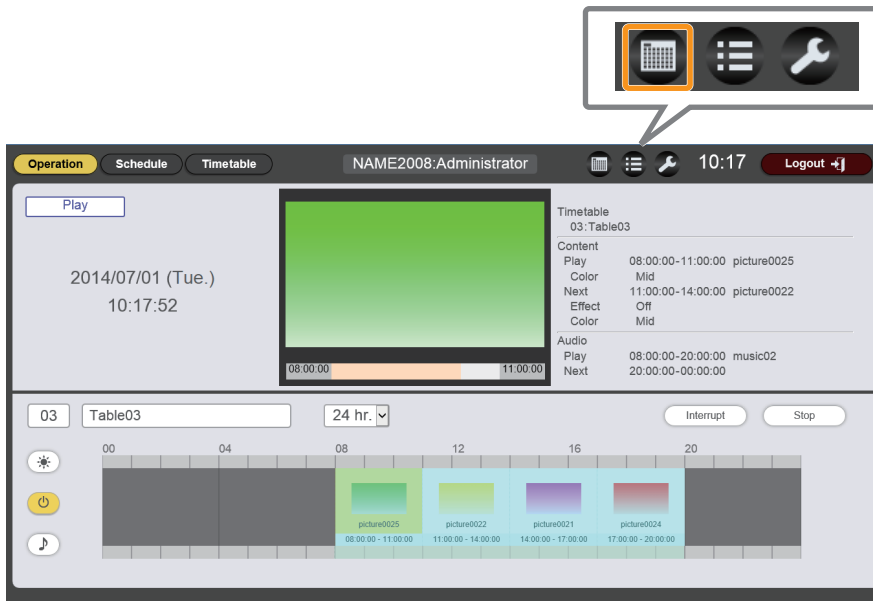

- 2) **Click [Schedule].**
 - The schedule confirmation screen is displayed.
- 3) **Click the day of which schedule you want to check on the calendar.**
 - The "Timetable" display is updated. Check the timetable set for the day.

Checking the playback history

Display the history of played contents for approximately one week.

1) On the start screen, click [Schedule].

- The schedule screen is displayed.

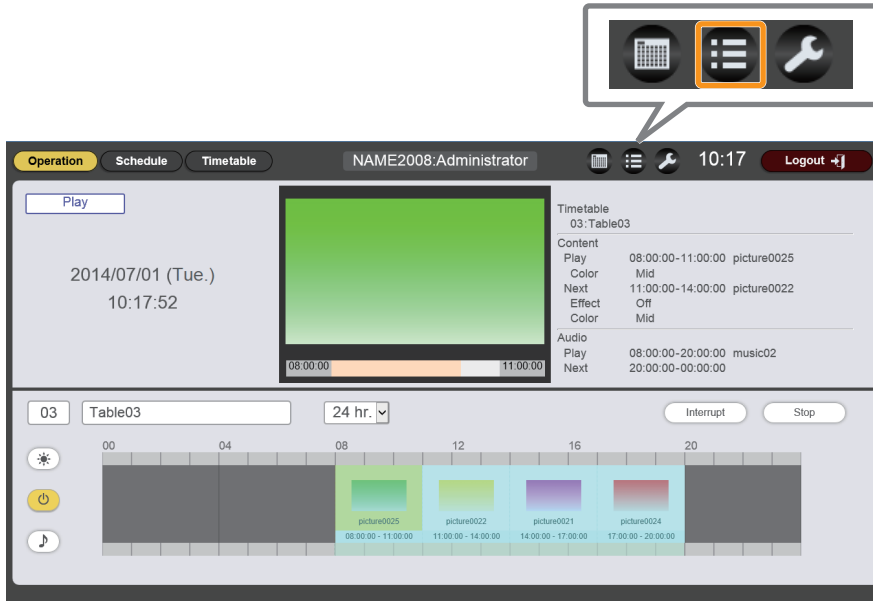

2) Click [History].

- The history screen is displayed. Check the content already played back.

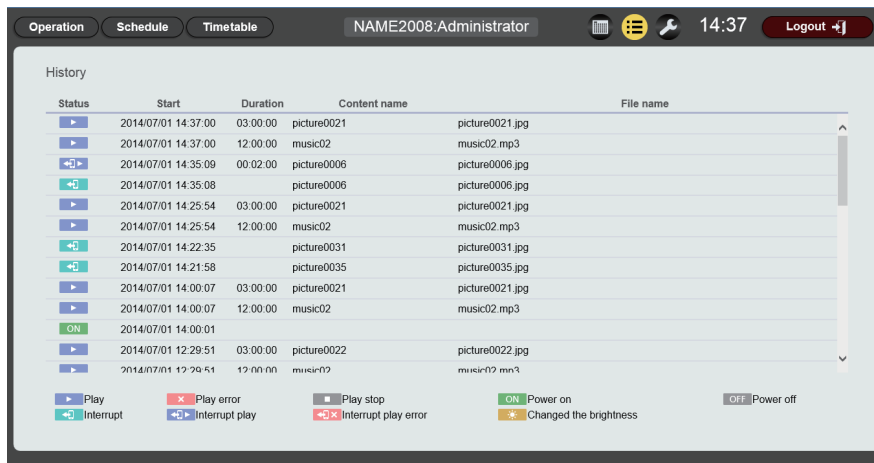

■ Display contents of the history

Icon	Details
	Played
	Playback failed
	Playback stopped
	Interruption occurred
	Interruption playback
	Interruption playback failed
	Brightness changed
	Power on
	Power off

Setting a schedule

Perform system setting, data management, and login information setting for the schedule.

1) On the start screen, click [Schedule].

- The schedule screen is displayed.



2) Click [Settings].

- The setting screen is displayed.

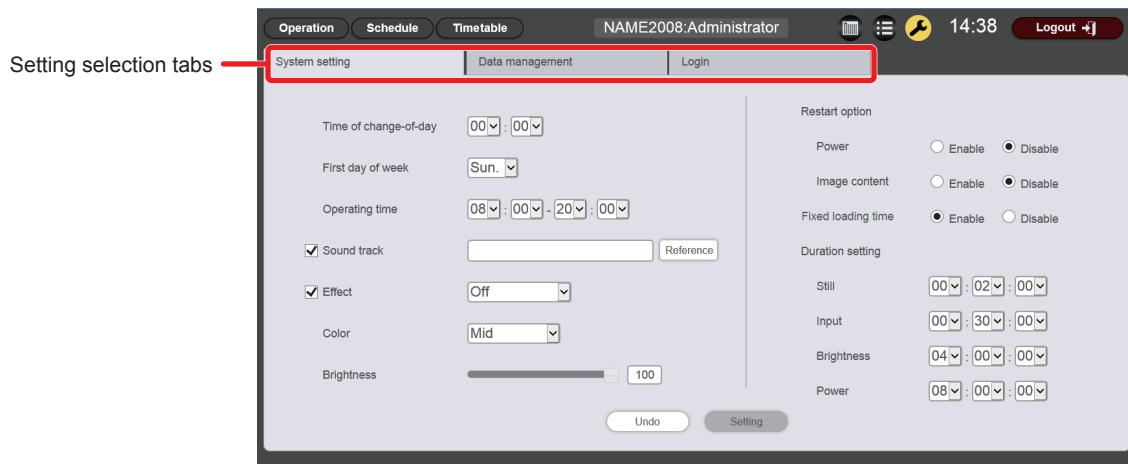

3) Select one of the setting selection tabs ([System setting]/[Data management]/[Login]).

- The page of the selected tab is displayed. Change the setting as necessary. For details, refer to the descriptions of the following items.
 - “Performing system settings” (⇒ page 177)
 - “Obtaining a backup of a schedule” (⇒ page 178)
 - “Uploading a schedule” (⇒ page 180)
 - “Changing login information” (⇒ page 181)

Performing system settings

Perform the system settings of schedule.

■ [System setting] page

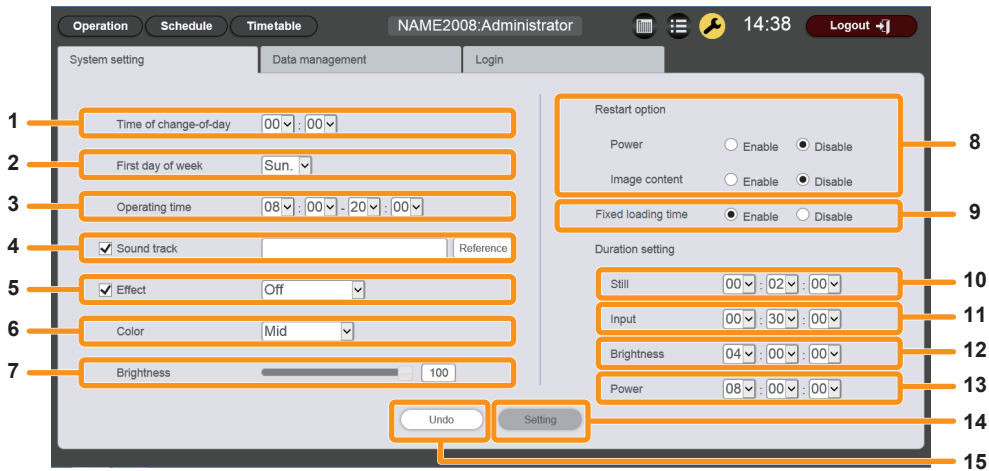

- 1 **[Time of change-of-day]**
Sets the time for the start of a day.
- 2 **[First day of week]**
Sets the day of the week for the start of a week in the schedule.
- 3 **[Operating time]**
Sets the time slot to start signage playback (schedule). It is used as the default power-on time of power supply content set when a new timetable is created.
- 4 **[Sound track]**
Sets the music content to be played as BGM during the time slot where no music content is registered in the timetable. Click the [Reference] button to select music content from the music content list. If the check box is not selected, BGM is disabled.
- 5 **[Effect]**
Sets the default image effect (special effect used when changing the playback screen) to be set when still image content is registered. For details of the setting items, refer to "[Effect]" (➔ page 197). If the check box is not selected, the image effect of the still image content registered in the timetable is disabled.
- 6 **[Color]**
Select the color setting to be reflected when playing image content. For details of the setting items, refer to "[Color]" (➔ page 198).
- 7 **[Brightness]**
Specifies the brightness to be reflected in the time slot where no brightness content is registered in the timetable.
- 8 **[Restart option]**
As a condition to resume the paused signage playback, sets enable/disable of [Power]/[Image content].
- 9 **[Fixed loading time]**
Select whether to fix the loading time after starting the scheduled movie content till displaying the image on the projection screen.
[Enable]:
Fixes the loading time after starting playback till displaying the image to three seconds.
[Disable]:
Displays the image as soon as the movie content has been loaded from the SD card after playback starts. Depending on the content, the loading time after starting playback till displaying the image will be less than three seconds.
- 10 **[Duration setting] - [Still]**
Sets the default playback time to be set when still image content is registered.
- 11 **[Duration setting] - [Input]**
Sets the default playback time which is set when external input content is registered.
- 12 **[Duration setting] - [Brightness]**
Sets the default playback time which is set when brightness content is registered.
- 13 **[Duration setting] - [Power]**
Sets the default playback time which is set when power supply content is registered.
- 14 **[Setting] button**
Click this to confirm the settings.
- 15 **[Undo] button**
Click this to undo the entered setting to the state before change.

■ Procedure

- 1) **Click the [System setting] tab.**
 - The [System setting] page is displayed.
- 2) **Perform various settings, and click the [Setting] button.**
 - Set contents are registered.

Note

- When [Power] and [Image content] in [Restart option] are set to [Enable] or [Disable], the following operations are applied.

[Power]	[Enable]	Signage playback (schedule) resumes when power off/on registered in the schedule is performed, or the power <ϕ/ > button on the remote control or power supply control by a command is performed, and then the input switches to signage.
	[Disable]	Signage playback does not resume even when power off/on registered in the schedule is performed, or the power <ϕ/ > button on the remote control or power control by a command is performed.
[Image content]	[Enable]	Signage playback (schedule) resumes at the playback start time of the image content (still image/movie/external input display content/playlist in the SD card) set in the schedule, and then the input switches to signage.
	[Disable]	Signage playback does not resume even at the start time of the image content (still image/movie/external input display content/playlist in the SD card) set in the schedule.

- When you set [Restart option] in the [System setting] page, the setting is reflected in the menu setting of the projector. Refer to “Setting the restart option” (➔ page 70) which explains the [SETUP] menu → [SIGNAGE].

Obtaining a backup of a schedule

Download a registered schedule into the client computer (only Windows computer/Mac are supported).

■ [Data management] page

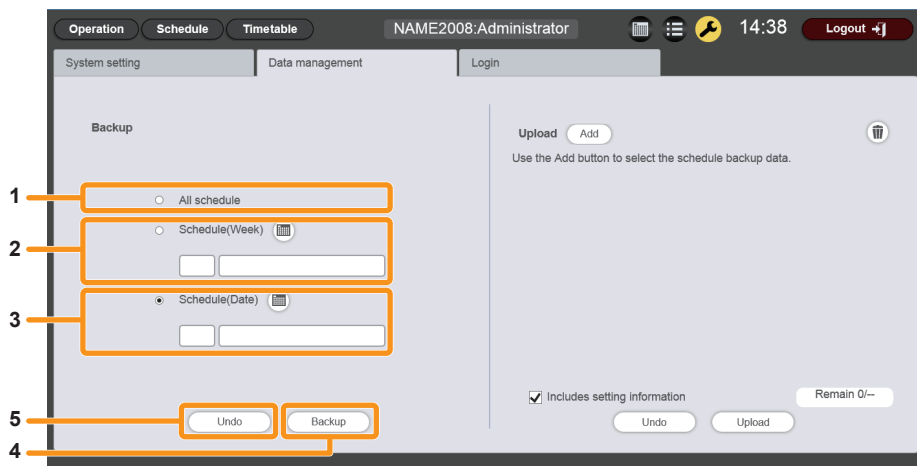

- [Backup] - [All schedule]**
Sets the backup target to be all schedules.
Select this radio button to include all the registered schedules in backup targets.
- [Backup] - [Schedule(Week)]**
Sets the backup target to be the schedule of day of the week.
When this radio button is selected, is enabled and a registered day of the week schedule can be selected.
- [Backup] - [Schedule(Date)]**
Sets the backup target to be the schedule of the specified date.
When this radio button is selected, is enabled and a registered schedule can be selected by specifying the date.
- [Backup] button**
Click this to save the selected backup target data into the client computer.
- [Undo] button**
Click this to undo the backup target setting to the state before displaying the [Data management] page.

■ [Backup file list] screen



1 Link to backup file

Displays a list of links to backup files.

2 Selected display

When the link to a backup file is clicked, [Already selected] is displayed.

Because this is displayed just by clicking a link without saving the relevant file, make sure to save all backup files.

■ Procedure

1) Click the [Data management] tab.

- The [Data management] page is displayed.

2) Select the method to select data to be the backup target using the radio buttons.

- Select the method from among [All schedule], [Schedule(Week)], and [Schedule(Date)].
- When [All schedule] is selected, proceed to Step 5).

3) Click .

- The backup target day of the week selection screen or the backup target date selection screen is displayed.

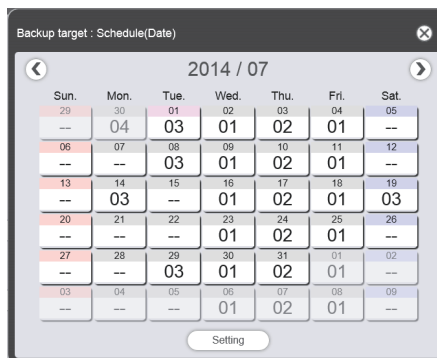
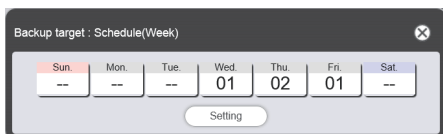

4) Select the date or day of the week in which the target schedule is registered, and click the [Setting] button.

- In the [Data management] page, the timetable ID and the timetable name are displayed.

5) Click the [Backup] button.

- The [Backup file list] screen is displayed.
- If the size of the backup target data is large, several backup files are created.

6) Click the link to the backup file, and save the file in any place.

- The screen to be displayed will differ depending on the web browser.

Note

- Backup data contains all information regarding the relevant schedule such as contents registered in the timetable and system setting information.
- Backup files are saved in tar format.
- Acquisition of backups of schedules are supported only in Windows computers or Mac.
- By uploading the obtained backup data to another projector equipped with the Content Manager, you can play back the same content in the same schedule.

Uploading a schedule

Upload a backed up schedule from the client computer (only Windows computer/Mac are supported) to the projector.

■ [Data management] page

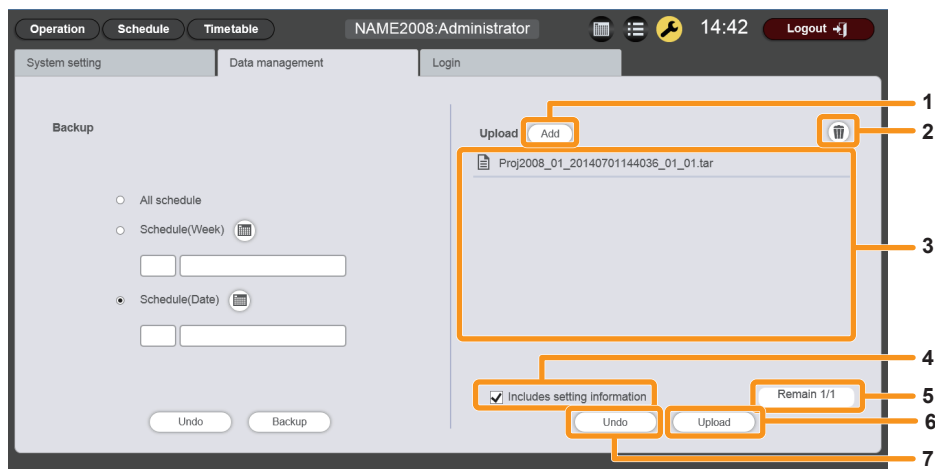

- 1 **Upload file [Add] button**
Adds upload target data.
Click this to display the file selection screen.
- 2 **Upload data deletion icon**
Click this to enter the deletion mode. Select data you want to cancel upload, and delete it.
- 3 **Upload data**
Displays upload target data in a list.
- 4 **[Upload] - [Includes setting information]**
If this check box is selected, the system setting information included in upload data is also uploaded.
- 5 **Upload data addition progress**
Displays the progress by comparing the number of saved data items when backup was obtained with the number of added upload target data items.
- 6 **[Upload] button**
Writes upload target data in the SD card of the projector.
- 7 **[Undo] button**
Clears upload target data.

■ Procedure

- 1) **Click the [Data management] tab.**
 - The [Data management] page is displayed.
- 2) **Click the upload file [Add] button.**
 - The file selection screen is displayed.
- 3) **Select a backup file to upload, and click the [Open] button.**
 - The file name is displayed in the upload data list.
 - Go back to Step 2) to continue to add another backup file, or go to Step 4) to cancel upload of a file, and then when you finish adding all backup files necessary to upload, proceed to Step 6).
- 4) **If there is a file you want to cancel upload, click .**
 - The mode changes to deletion mode.

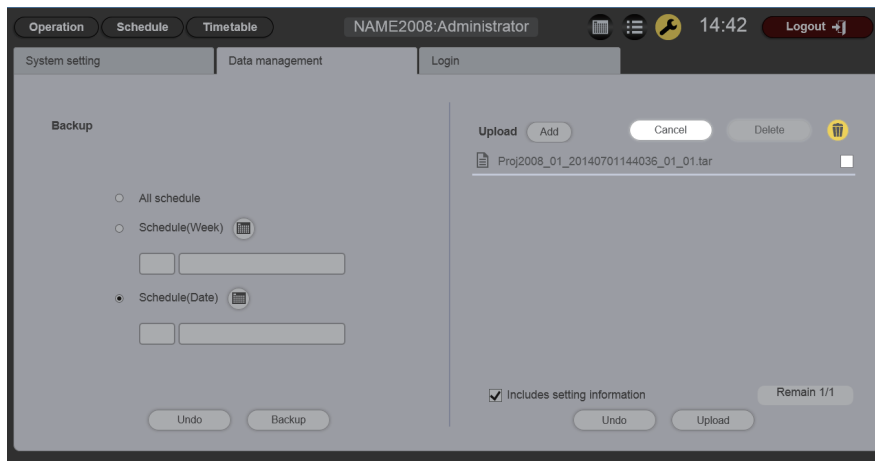

5) **Select a file you want to cancel upload, click [Delete].**

- You can select multiple files.

6) **Click the [Upload] button.**

- The upload target schedule is registered in the SD card.

Note

- When the upload destination SD card contains the same day of the week schedule, or the same date schedule, the schedule is overwritten with the uploaded schedule.
- Backup files are saved in tar format.
- If the size of the original backup data is large, several backup files may have been created to save the data. Make sure to add all the relevant files before upload.
- Upload of schedules is supported only in Windows computers or Mac.
- The timetable ID registered when a schedule has been uploaded may vary depending on the schedule registration situation of the upload destination.

Changing login information

Set the user name and password for logging in to the Content Manager for administrator rights/user rights respectively.

■ **[Login] page**

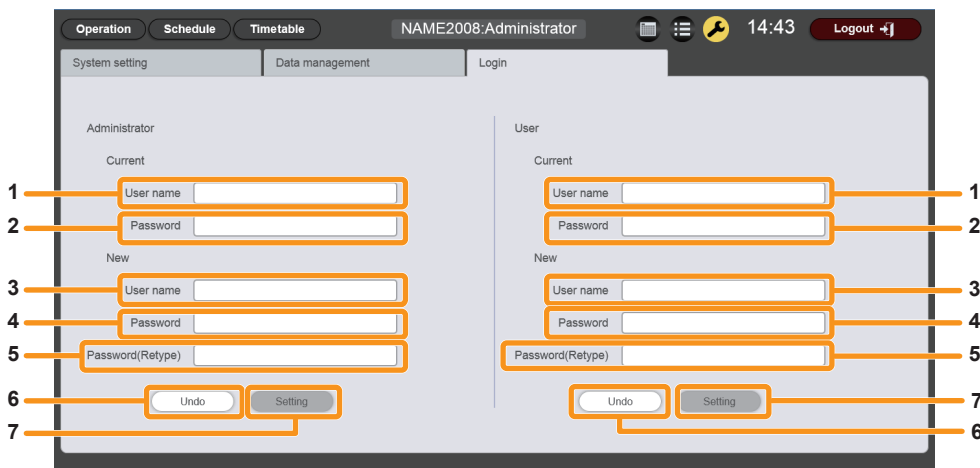

- 1 **[Current] - [User name]**
Enter the current user name. (Up to 8 alphanumeric characters in single byte)
- 2 **[Current] - [Password]**
Enter the current password. (Up to 16 alphanumeric characters in single byte)
- 3 **[New] - [User name]**
Enter the desired new user name. (Up to 8 alphanumeric characters in single byte)

- 4 **[New] - [Password]**
Enter the desired new password. (Up to 16 alphanumeric characters in single byte)
- 5 **[New] - [Password(Retype)]**
Enter the desired new password again.
- 6 **[Undo] button**
Click this to clear the entered information.
- 7 **[Setting] button**
Click this to confirm the settings.

■ **Procedure**

- 1) **Click the [Login] tab.**
 - The [Login] page is displayed.
- 2) **Enter the current user name and password.**
- 3) **Enter the desired new user name and password.**
- 4) **Enter the desired new password again.**
- 5) **Click the [Setting] button.**
 - Set contents are registered in the projector.

Playing back the schedule simultaneously in multiple projectors

By synchronizing the date and time of the projector with the NTP server, you can meet the playback timing of the schedule among multiple projectors. Use this function when you set up multiple projectors of this model in the same floor or other close location and play back the same schedule.

Please note that even when the date and time are adjusted, a time lag of maximum one second may occur in the schedule or the starting or ending timing of playback for each content registered in the schedule. Music content does not support simultaneous playback.

- 1) **Set [STANDBY MODE] to [NORMAL].**
 - For details on the [STANDBY MODE] setting, refer to “Setting [STANDBY MODE]” (➔ page 72).
- 2) **Set the schedule for simultaneous playback.**
 - “Setting schedules for simultaneous playback” (➔ page 182)
- 3) **Set the following items.**
 - “Duplicating schedules” (➔ page 182)
 - “Setting synchronization for the NTP server” (➔ page 184)
 - “Enabling [Fixed loading time]” (➔ page 185)
- 4) **Start playback of the schedule in each projector.**
 - “Starting playback of a schedule” (➔ page 166)

Note

- To synchronize with the NTP server and perform simultaneous playback, the network for the target projectors must be established. For details on establishing the network, refer to “Network connection” (➔ page 101).
To connect the projectors via wireless LAN, set the [NETWORK] menu → [WIRELESS LAN] to [USER1], [USER2], or [USER3]. If [M-DIRECT] or [S-DIRECT] is set, the projector cannot be synchronized with the NTP server.
- To connect the projectors via wireless LAN, access point is required.
- Approximately 5 minutes (up to 15 minutes depending on the condition of the NTP server) are required to complete the synchronization with the NTP server after the power is supplied to the projector and the projector enters in the standby mode. If the schedule is played back during this period, a time lag of more than one second may occur between the projectors in the starting or ending timing of content playback.
- To perform simultaneous playback, use the following movie file as a movie content. If you use the movie files other than the following, simultaneous playback function may not work properly.
 - Extension: mp4, Video codec: H.264/MPEG-4 AVC, Audio codec: AAC
 - Extension: mpg/mpeg, Video codec: MPEG-2, Audio codec: MPEG-1/2 Audio Layer-2
- When synchronizing with the NTP server and performing simultaneous playback, the following may occur.
 - If [STANDBY MODE] is set to an item other than [NORMAL], the image will disappear temporarily when synchronizing with the NTP server once after you have turned on the power or the power has been turned on.
 - Depending on the network environment such as unstable communication condition, access to the NTP server may become unavailable. In such a case, the image may disappear temporarily when you synchronize with the server again after the synchronization was interrupted.

Setting schedules for simultaneous playback

Set the schedule for simultaneous playback using any one of the Content Manager in multiple projectors of this model. Refer to “Procedure for setting the schedule” (➔ page 159) for how to set the schedule. Based on the schedule set in that section, the same schedule data will be duplicated in SD cards of other projectors for simultaneous playback.

Note

- Music content does not support simultaneous playback. If you play back the schedule containing music content simultaneously in multiple projectors, use audio output of any one of the projectors.

Duplicating schedules

To play back the same schedule simultaneously, the same schedule including contents must be registered in the SD card inserted in each projector. There are three ways to duplicate the schedule. Use any one to duplicate the schedule.

- “Duplicating data in SD card” (➔ page 183)
- “Downloading/uploading schedules using the Content Manager” (➔ page 183)
- “Acquiring and delivering schedules using “Multi Projector Monitoring & Control Software”” (➔ page 184)

Duplicating data in SD card

If you can eject the SD card where the source schedule has been registered, you can duplicate data in the SD card using the following procedure. Please note that the environment where data can be duplicated from the SD card to other SD cards is required.

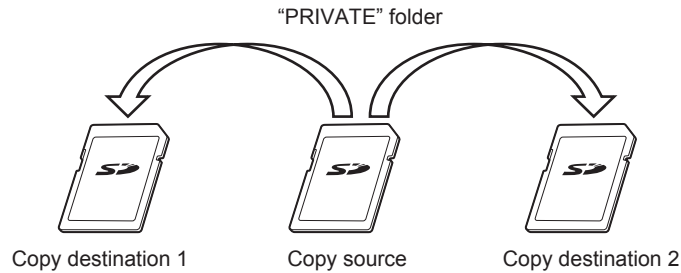

- 1) Eject the SD card where the source schedule has been registered from the projector.
- 2) Duplicate the source SD card data to the destination SD cards (required number of cards).
 - Duplicate the “PRIVATE” folder in the root (top-most directory) of the source SD card to the root in the destination SD card.
- 3) Insert the SD cards containing data duplicated in Step 2) into the SD card slot of each projector for simultaneous playback.

Downloading/uploading schedules using the Content Manager

By using the Content Manager, you can register the same schedules in other projectors while the SD card with the duplication source schedules is inserted in the SD card slot of the projector.

Operate the web browser on the client computer (only Windows computer/Mac supported).

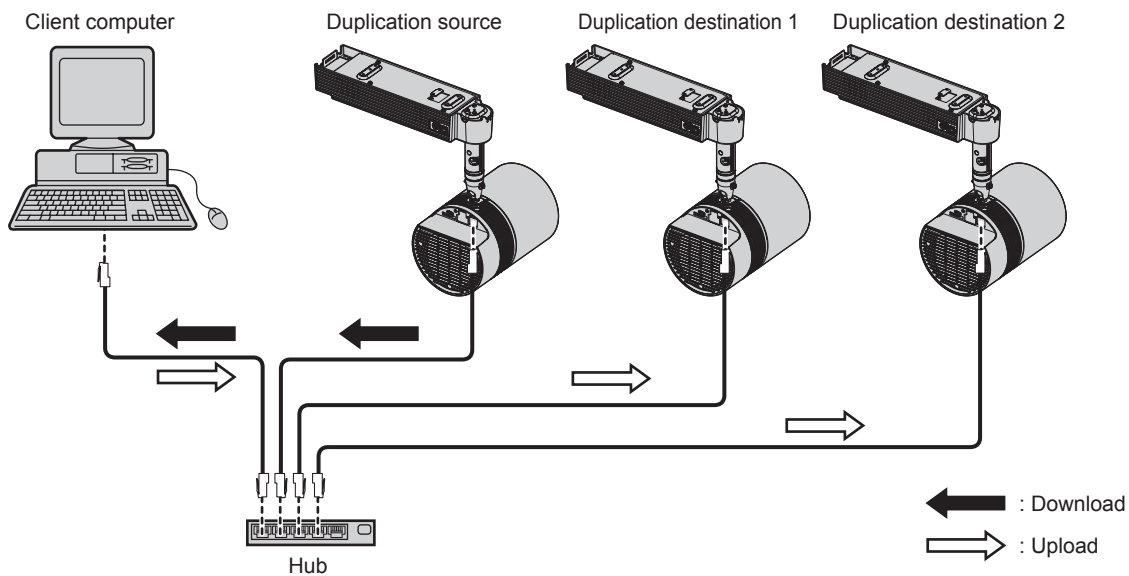

(Example) Illustration of connecting via wired LAN

- 1) Log in to the Content Manager of the duplication source projector from the web browser.
 - For details on the login procedure, refer to “Logging in to the Content Manager” (➡ page 129).
- 2) Download the registered schedules as backup data.
 - For the backup procedure, refer to “Obtaining a backup of a schedule” (➡ page 178).
- 3) Log out from the Content Manager of the duplication source projector.
 - For the logout procedure, refer to “Logging out from the Content Manager” (➡ page 131).
- 4) Log in to the Content Manager of the duplication destination projector from the web browser.
- 5) Upload the schedules downloaded in Step 2) to the duplication destination projector.
 - For the upload procedure, refer to “Uploading a schedule” (➡ page 180).

- Upload the backed up schedules to all projectors for simultaneous playback.

Acquiring and delivering schedules using “Multi Projector Monitoring & Control Software”

Using “Multi Projector Monitoring & Control Software”, you can deliver and register the same schedules in other projectors while the SD card with the duplication source schedules is inserted in the SD card slot of the projector. “Multi Projector Monitoring & Control Software” is included in the supplied CD-ROM.

1) Start up “Multi Projector Monitoring & Control Software”.

- If the target projector is not registered, follow “Projector Registration” in the Operating Instructions of “Multi Projector Monitoring & Control Software” to register the projector.

2) Acquire the signage schedule from the duplication source projector.

3) Deliver the signage schedule to the duplication destination projector or a group.

Note

- For the procedure of acquiring and delivering schedules, refer to “Acquiring and Delivering a Signage Schedule” in the Operating Instructions of “Multi Projector Monitoring & Control Software”.

Setting synchronization for the NTP server

To perform simultaneous playback of the same schedule in multiple projectors continuously, synchronize the projectors with the NTP server and adjust the date and time setting of target projectors.

The projector is equipped with the NTP server function. By using one of multiple projectors of this model as the NTP server function, the time of other projectors can be synchronized, under the environment where access to the external NTP server is not possible.

1) Start up the web browser on the computer.

2) Access the projector from the web browser.

- For the procedure of accessing the projector from the web browser, refer to “Accessing from the web browser” (➔ page 105).

3) On the [Adjust clock] page of the web control screen, select [Time Zone].

- The schedule is played back based on the local date and time set in the projector. Set the same time zone for the projectors performing simultaneous playback.

4) On the [Adjust clock] page of the web control screen, set [NTP SYNCHRONIZATION] to [ON].

5) Enter the IP address or server name of the NTP server in [NTP SERVER NAME] of the [Adjust clock] page.

- To use one of multiple projectors of this model as the NTP server, enter the IP address set for the projector.
- To enter the server name, the DNS server needs to be set up. For setting the DNS server, refer to “[Network config] page” (➔ page 112).
- For details on setting the NTP server, refer to “[Adjust clock] page” (➔ page 114).

6) Click the [Set date and time] button on the [Adjust clock] page to apply the setting.

- After a while, the projector is synchronized with the time of the NTP server.

Note

- To use the projector as the NTP server, set [NTP SYNCHRONIZATION] to [OFF], and then set the date and time.
- The settings of [Time Zone], [NTP SYNCHRONIZATION], [Date], and [Time] on the [Adjust clock] page can also be configured from the [SETUP] menu → [DATE AND TIME] (➔ page 74). The NTP server can be set only on the [Adjust clock] page of the web control screen.
- For details on a computer that can be used for setting the web control screen, refer to “Computer that can be used for setting” (➔ page 105).
- If you use the projector as the NTP server, approximately 15 minutes are required after configuring the synchronization setting of other projectors till completing synchronization. After configuring the synchronization setting, wait for more than 15 minutes before starting playback of the schedule.
- When the projector is used as the NTP server, approximately 15 minutes are required before completing synchronization if the time setting of the NTP server is changed. Keep this in mind when operating the simultaneous playback of the schedule.

Enabling [Fixed loading time]

Even when the time of the projectors for simultaneous playback is synchronized, the loading time after starting playback till the image is actually displayed on the projection screen will differ among the projectors, depending on the movie content registered in the schedule. If you play back the schedule containing a movie content, it is recommended to enable [Fixed loading time] and fix the loading time (three seconds) after starting playback till displaying the image.

Operate the web browser on the client computer (only Windows computer/Mac supported).

- 1) **Log in to the Content Manager of the projector for simultaneous playback from the web browser.**
 - For details on the login procedure, refer to “Logging in to the Content Manager” (➔ page 129).
- 2) **On the [System setting] page, set [Fixed loading time] to [Enable].**
 - For details on [Fixed loading time], refer to “Performing system settings” (➔ page 177).

Note

- If [Fixed loading time] is set to [Disable], the image will be displayed as soon as the movie content data has been loaded from the SD card after playback starts. Depending on the content, the loading time after starting playback till displaying the image will be less than three seconds.

[Slideshow]

Set and play a slideshow.

Slideshow screen

Click [Slideshow] on the start screen to display the slideshow screen.

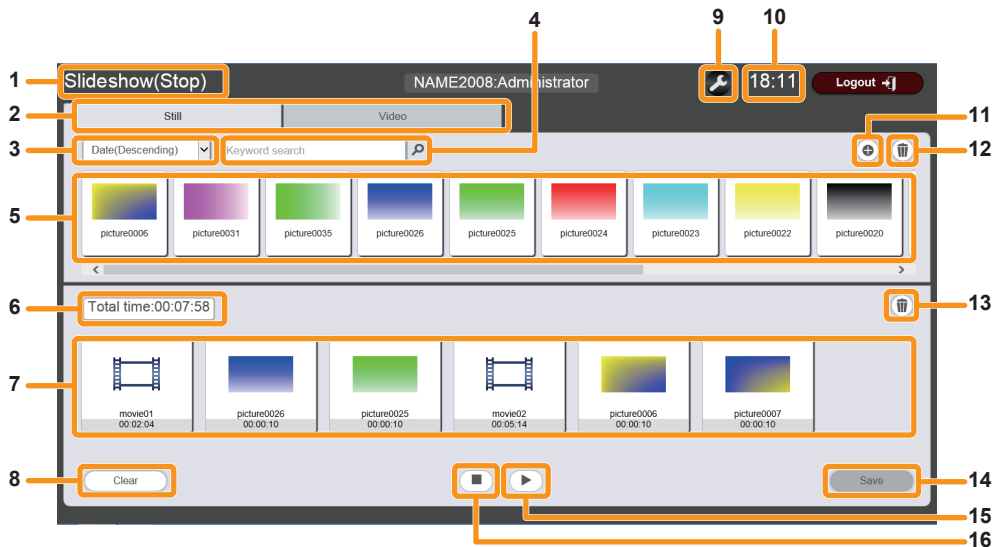

- | | |
|--|---|
| <p>1 Playback status
Displays the status of signage playback (slideshow).</p> <p>2 Content selection tab
Select the type of content (still image or movie) to register in a slideshow.</p> <p>3 Sort content
Select the display order of the “Content list”.
 [Date(Ascending)]/[Date(Descending)]:
 Displays contents in the order of registration date.
 [Content name(Ascending)]/[Content name(Descending)]:
 Displays contents in the name order.
 [File name(Ascending)]/[File name(Descending)]:
 Displays contents in the file name order.</p> <p>4 [Keyword search]
Enter string to be searched and click to search contents (still image or movie) saved in the “PRIVATE” folder in the SD card by content name and file name. The search result is displayed in the content list.</p> | <p>5 Content list
Displays contents (still image or movie) registered in the SD card.</p> <p>6 [Total time]
Displays the total time of the contents registered in a slideshow.</p> <p>7 Slideshow
Displays the contents registered in a slideshow.</p> <p>8 [Clear] button (only for administrator rights)
Click this to delete all contents registered in a slideshow.</p> <p>9 Settings icon (only for administrator rights)
Click this to display the slideshow setting screen. Make various settings of a slideshow. (“Setting a slideshow” ➔ page 190)</p> <p>10 Projector time
Displays the time of the connected projector.</p> <p>11 Content addition icon (only for administrator rights)
Adds and registers contents in the SD card. (“Registering content” ➔ page 187))</p> <p>12 Content deletion icon (only for administrator rights)
Deletes contents registered in the SD card. (“Deleting content” ➔ page 189))</p> |
|--|---|

13 Content in slideshow deletion icon (only for administrator rights)

Deletes contents registered in a slideshow. ("Deleting content from a slideshow" (➔ page 191))

14 [Save] button (only for administrator rights)

Click this to register the slideshow setting in the SD card.

15 Playback/Pause icon (only for administrator rights)

Click this to start playing a slideshow or to pause it.

16 Stop icon (only for administrator rights)

Click this to stop playing the slideshow.

Registering a slideshow setting

Register contents in a slideshow.

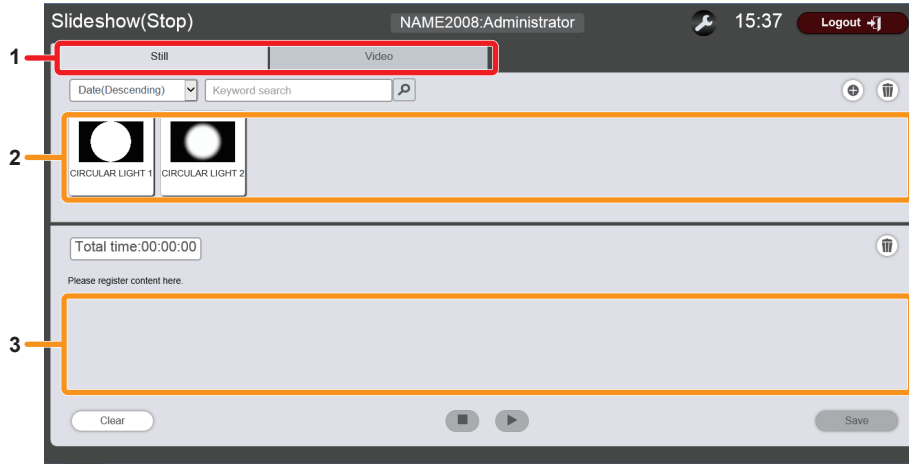

1 Content selection tab

2 Content list

3 Slideshow

1) Click the tab of the content to register in the slideshow from the "Content selection tab" ([Still] or [Video]).

- Clicking the tab changes the "Content list" display to still image or movie.

2) Register a content in the content list.

- To register still image/movie contents in the slideshow, register still image/movie files in the content list in advance. For details on registration procedure, refer to "Registering content" (➔ page 187).

3) Register contents in the slideshow.

- Drag and drop the content to be registered in the slideshow from the "Content list" into the "Slideshow".

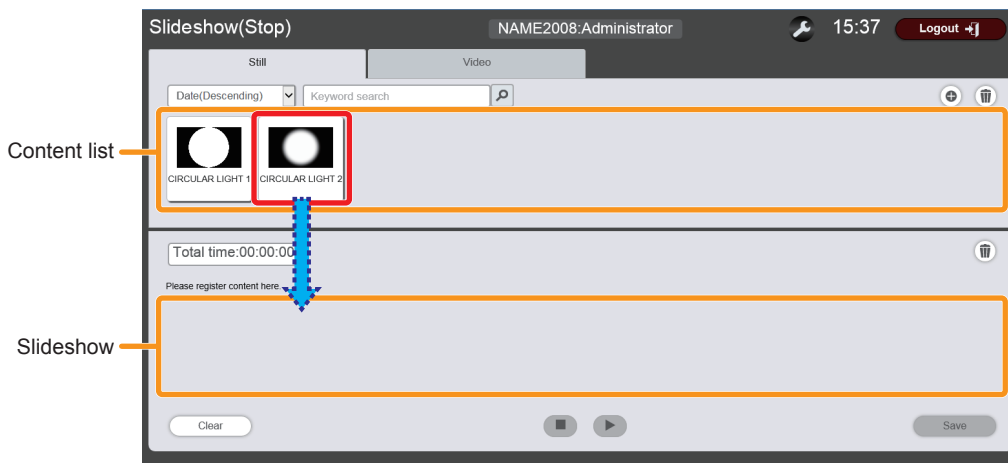

- You cannot register multiple contents in a batch. To continue to register another content, go back to Step 1) and perform the procedure.
- When registering contents in a slideshow, you cannot specify the position to insert the contents. After registering the contents in the "Slideshow", perform the procedure according to "Changing the order of contents" (➔ page 191).

4) Click the [Save] button.

- The slideshow setting is registered in the SD card.

Note

- Only one slideshow setting can be registered in one SD card.

- In a slideshow, you can register up to 100 contents (still image/movie files).
- You cannot register contents other than still image/movie.
- To add and register new contents to the “Content list”, refer to “Registering content” (➔ page 187).

Editing the content list

Register still image/movie contents to be used for the slideshow in the content list or delete them from the content list.

Refer to the descriptions of the following items.

- “Registering content” (➔ page 187)
- “Deleting content” (➔ page 189)

Registering content

Register still image/movie files in the SD card as contents from the client computer.

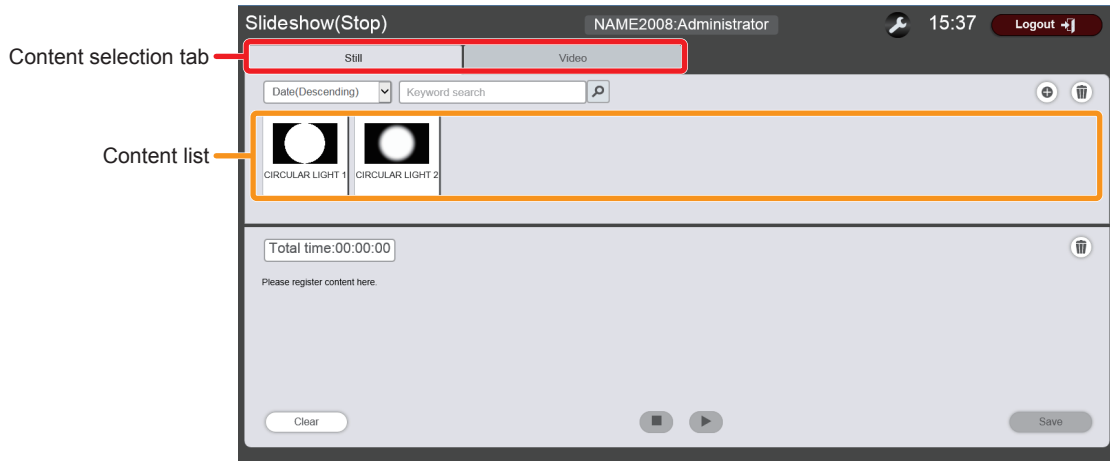

- 1) Click the tab of the content to register from the “Content selection tab” ([Still] or [Video]).
 - Clicking the tab changes the “Content list” display.



- 2) Click ⊕.
 - The [Add content] screen is displayed.

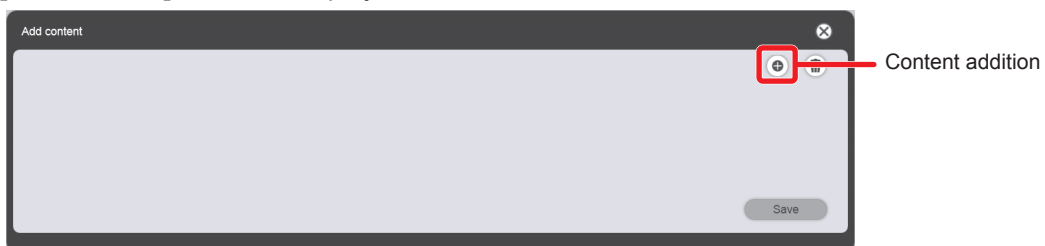

- 3) Click ⊕ on the [Add content] screen.
 - The file selection screen is displayed.

4) **Select the content to register (1 file at a time), and click the [Open] button.**

- The content name entry screen is displayed.

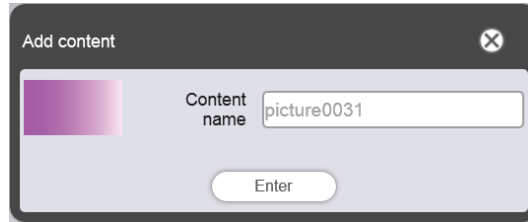

5) **Enter any [Content name], and click the [Enter] button.**

- For [Content name], up to 24 characters in single byte can be entered.
- Even when the content name is different from the file name, the file name itself is not changed.
- The content is registered in the [Add content] screen.

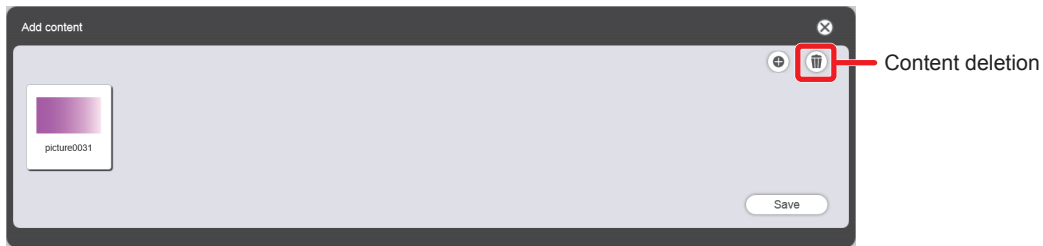

- To continue to add content, go back to Step 3), or to delete content from the [Add content] screen, go to Step 6), and to end adding content, proceed to Step 10).
- Up to 10 contents can be registered in the [Add content] screen.

6) **To cancel addition of content, click  on the [Add content] screen.**

- The mode changes to deletion mode.

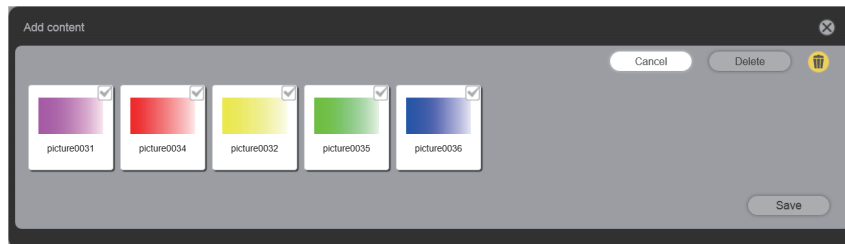

7) **Select the content for which you want to cancel addition.**

- You can select multiple contents.

8) **Click the [Delete] button.**

9) **When the confirmation screen is displayed, click the [OK] button.**

10) **When addition of contents to register is complete, click the [Save] button.**

- Added contents are registered in the SD card.

Note

- The maximum number of still image/movie files that the Content Manager can control is 500 each. However, it may not be possible to register 500 files depending on the capacity of the SD card.

Deleting content

Delete unnecessary content from the SD card.

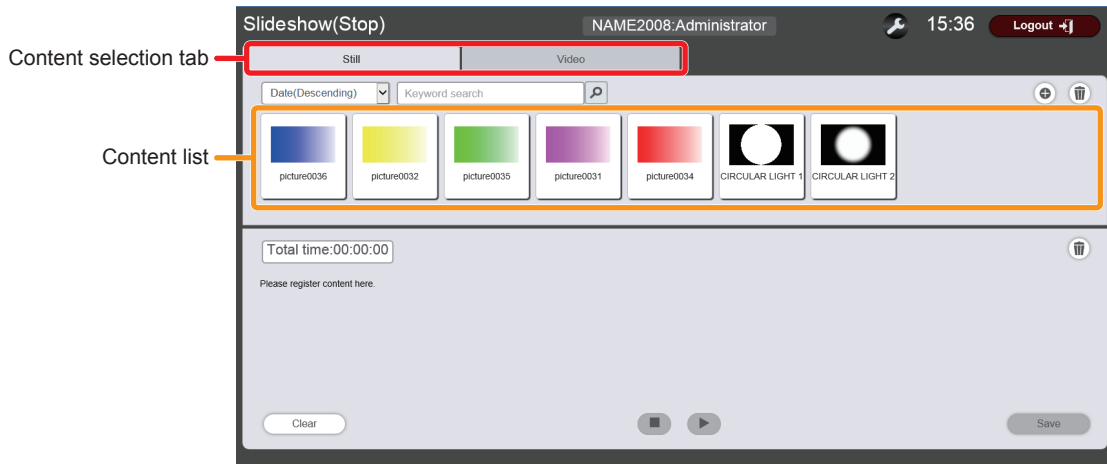

- 1) **Click the tab of the content to be deleted from the “Content selection tab” ([Still] or [Video]).**
 - Clicking the tab changes the “Content list” display.

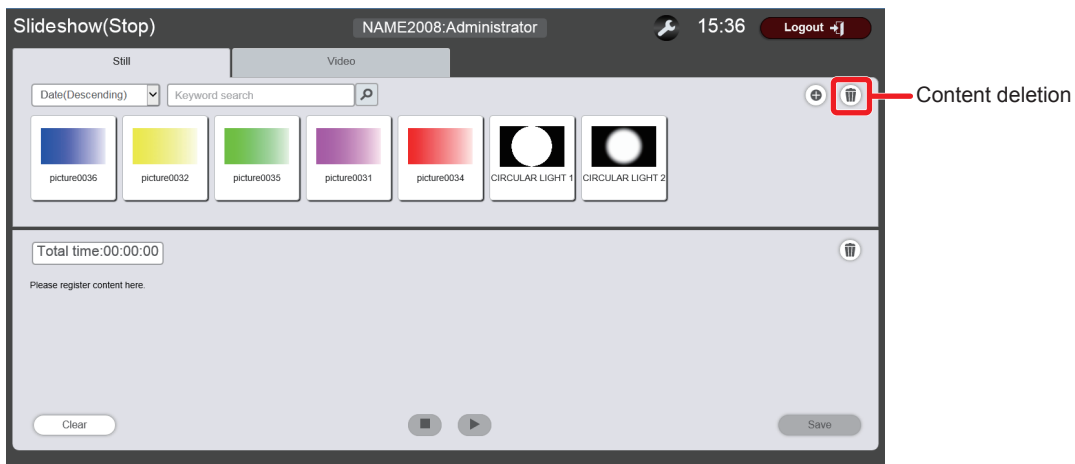

- 2) **Click .**
 - The mode changes to deletion mode.

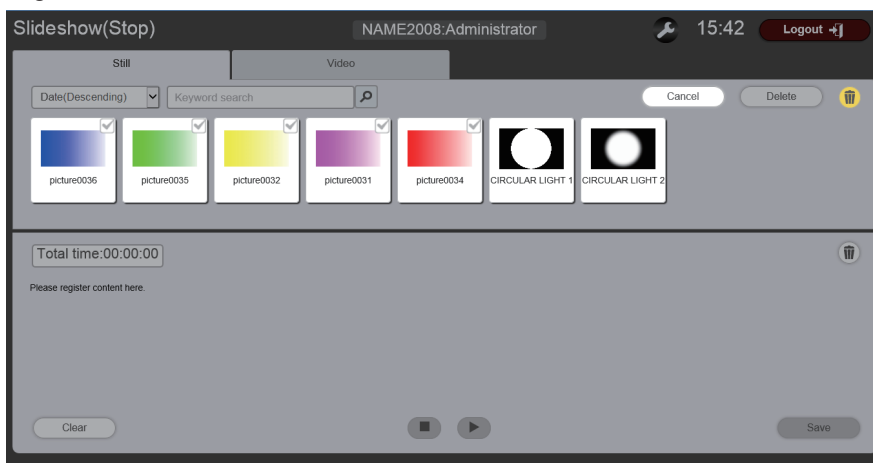

- 3) **Select the content to delete.**
 - You can select multiple contents.
- 4) **Click the [Delete] button.**
- 5) **When the confirmation screen is displayed, click the [OK] button.**
 - The selected content is deleted from the SD card.

Note

- If the content to be deleted is registered in a schedule or slideshow, the content cannot be deleted.
- [CIRCULAR LIGHT1] and [CIRCULAR LIGHT2] in still image content cannot be deleted.

Setting a slideshow

Make various settings of a slideshow.

■ **Slideshow screen**



■ **Slideshow setting screen**

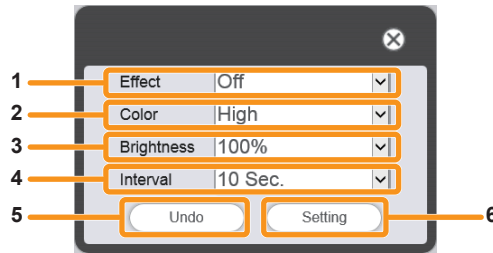

- | | |
|---|--|
| <p>1 [Effect]
Select the default image effect (special effect used when changing the playback screen) to be set when still image content is registered in a slideshow.
For details of the setting items, refer to “[Effect]” (➡ page 197).</p> <p>2 [Color]
Select the color setting to be reflected when playing a slideshow.
For details of the setting items, refer to “[Color]” (➡ page 198).</p> | <p>3 [Brightness]
Select the brightness to be reflected when playing a slideshow.</p> <p>4 [Interval]
Sets the default playback time which is set when still image content is registered in a slideshow.</p> <p>5 [Undo] button
Click this to undo the entered setting to the state before the setting screen was displayed.</p> <p>6 [Setting] button
Click this to confirm the settings.</p> |
|---|--|

■ **Procedure**

- 1) Click .
 - The slideshow setting screen is displayed.
- 2) Click the [Setting] button.
 - Set contents are registered.

Editing a slideshow setting

Refer to the descriptions of the following items.

- “Changing the order of contents” (➡ page 191)
- “Deleting content from a slideshow” (➡ page 191)
- “Changing the still image content setting” (➡ page 192)

Changing the order of contents

Change the playback sequence of contents registered in a slideshow.

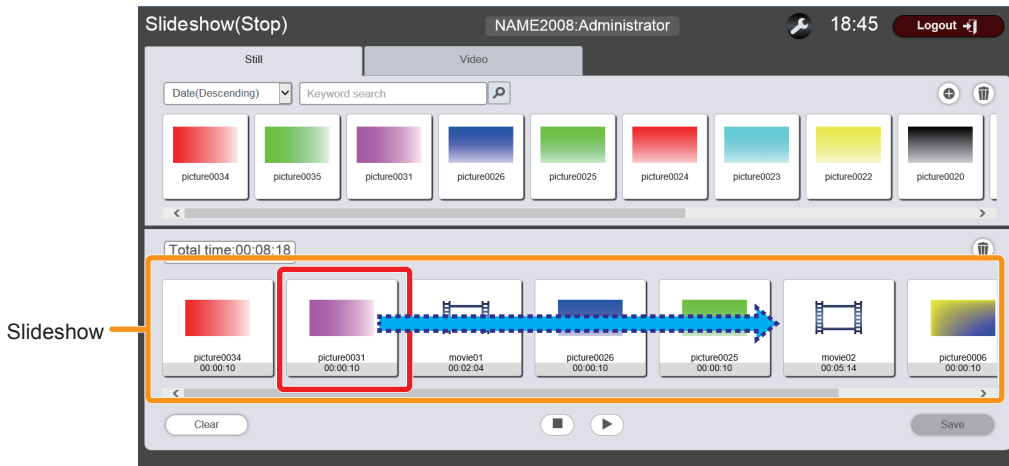

- 1) Move the content of which order you want to change using a drag-and-drop operation in the "Slideshow".

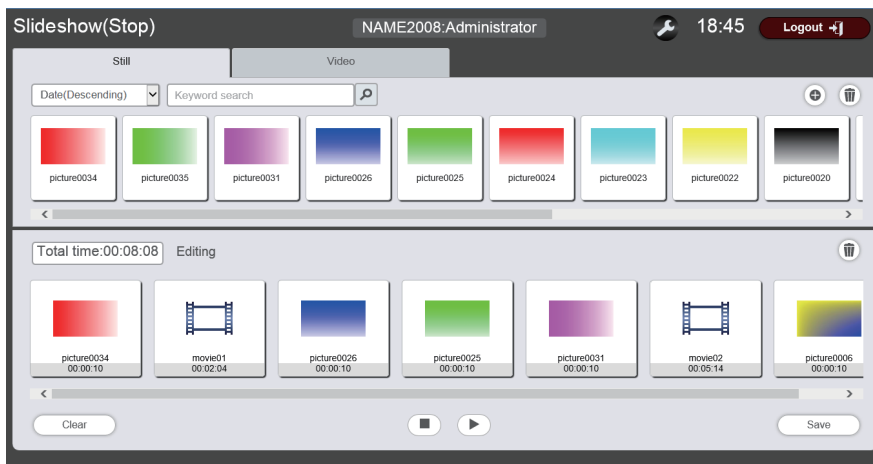

- 2) Click the [Save] button.
 - The edited slideshow setting is registered in the SD card.

Deleting content from a slideshow

Delete contents registered in a slideshow.

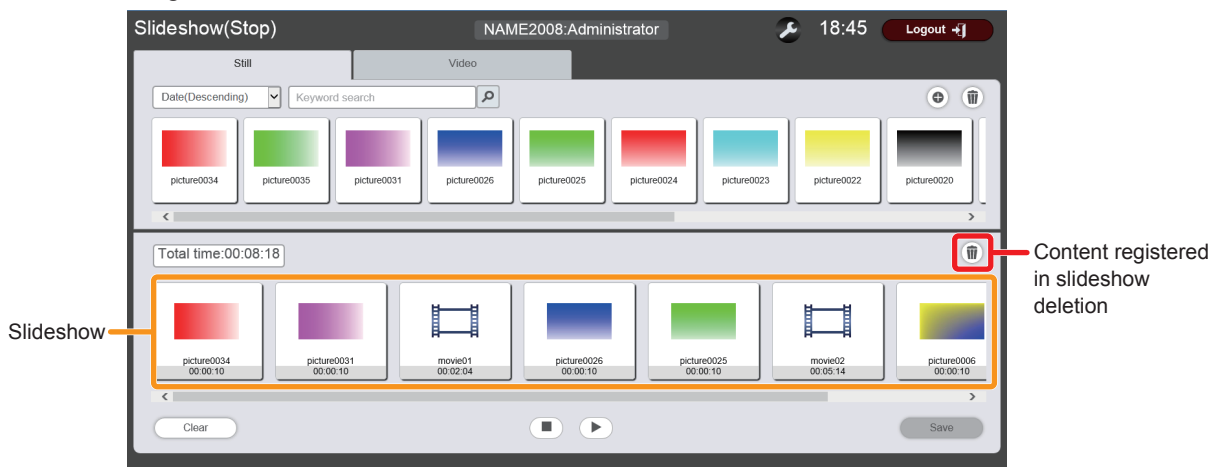

- 1) Click  in the “Slideshow”.
 - The mode changes to deletion mode.



- 2) Select the content to delete.
 - You can select multiple contents.
- 3) Click the [Delete] button.
- 4) When the confirmation screen is displayed, click the [OK] button.
- 5) Click the [Save] button.
 - The edited slideshow setting is registered in the SD card.

Changing the still image content setting

Change the setting of still image contents registered in a slideshow.

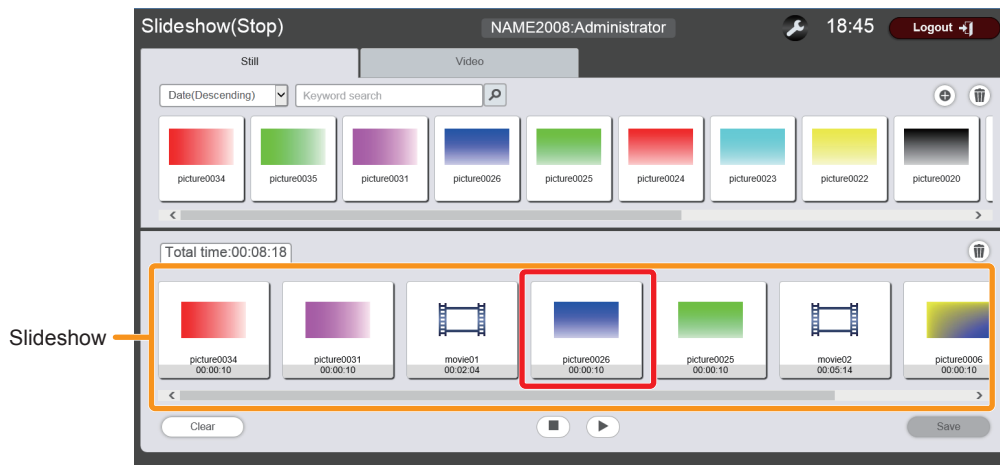

- 1) Click the still image content registered in the “Slideshow”.
 - The setting screen is displayed.

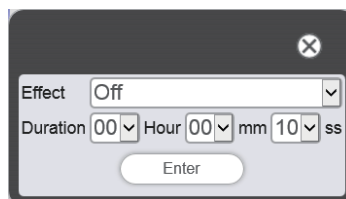

- 2) Change [Effect] and [Duration], and click the [Enter] button.
 - Change the image effect and playback time settings.
- 3) Click the [Save] button.
 - The edited slideshow setting is registered in the SD card.

Note

- You cannot change movie content settings. The playback time of movie content in a slideshow is the required playback time of the movie content.

Starting a slideshow

Start playing a slideshow.

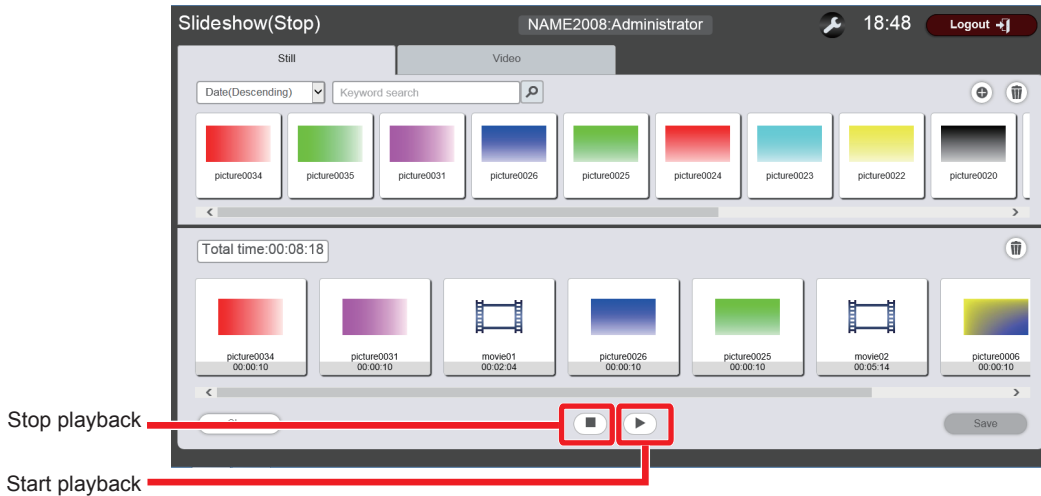

- 1) Click .
 - changes to .
 - To pause the playback of the slideshow, click .
 - To stop the playback of the slideshow, click .

Note

- When you pause playing still image content, the playback time of the paused content is reset when it is resumed and played from the beginning. In the case of movie content, the playback resumes from the paused part.

Registering a lighting pattern

Register lighting patterns to be used in the settings [SD1] to [SD10] of the [LIGHTING] menu → [PATTERN] (➡ page 60) of the projector, in the SD card as still image contents.

- Refer to “Cards that can be used with the projector” (➡ page 49) for SD cards that can be used with the projector.

1) **Save the still image files to be used as lighting patterns in any place in the client computer.**

- The file names corresponding to the respective settings [SD1] to [SD10] are as follows. Change the file names in advance.

[PATTERN]	Corresponding file name
[SD1]	SD1.bmp/SD1.jpg/SD1.jpeg
[SD2]	SD2.bmp/SD2.jpg/SD2.jpeg
...	...
[SD10]	SD10.bmp/SD10.jpg/SD10.jpeg

2) Log in to the Content Manager with administrator rights.

- The start screen is displayed.

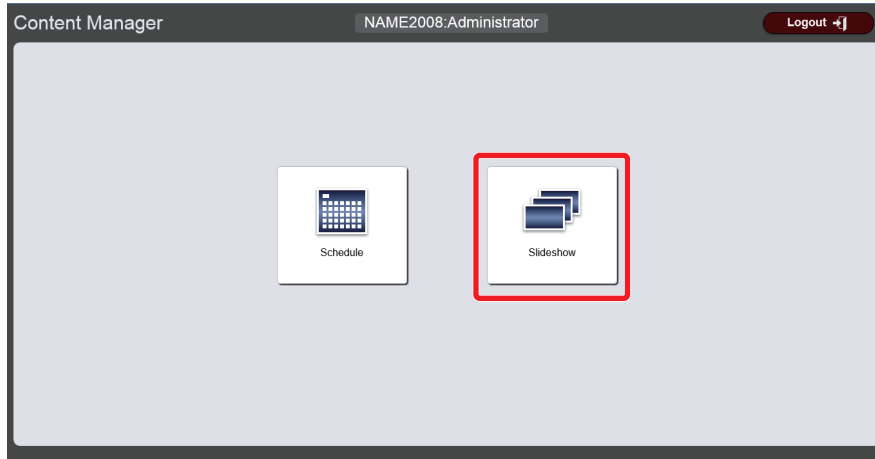

3) Click [Slideshow].

- The slideshow screen is displayed.

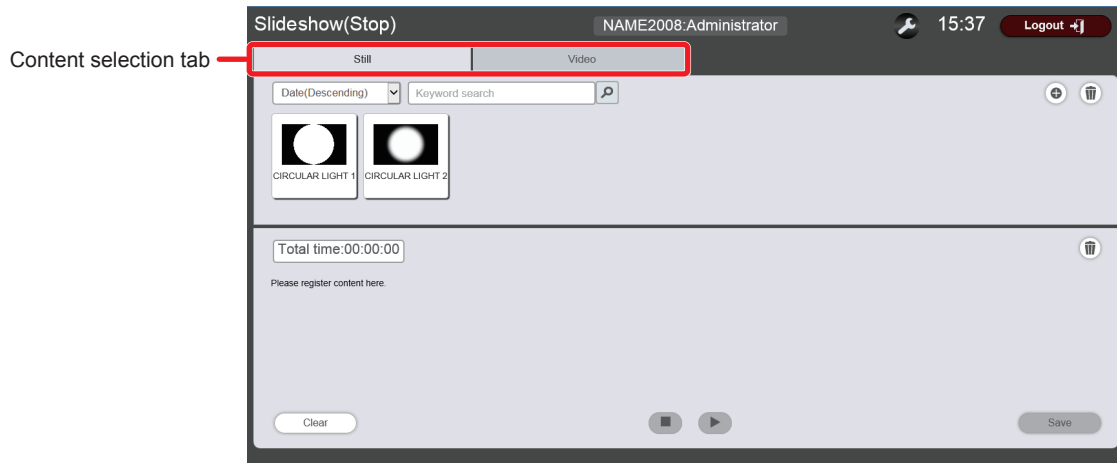

4) Click the [Still] tab among the “Content selection tab”.

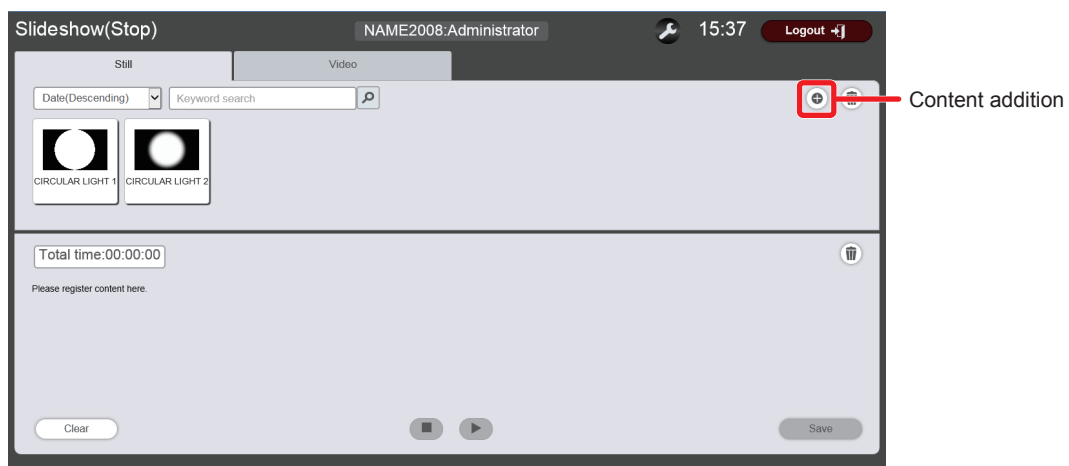

5) Click +.

- The [Add content] screen is displayed.

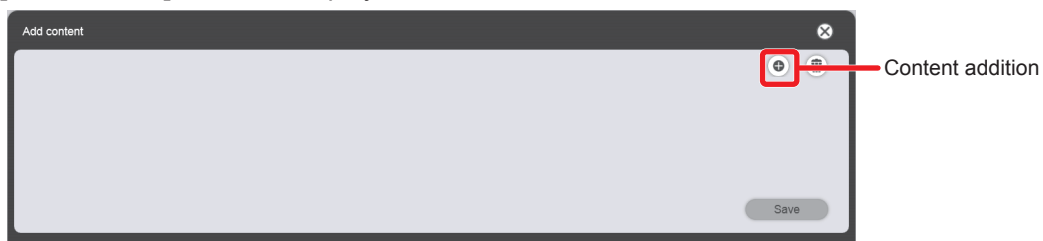

6) Click .

- The file selection screen is displayed.

7) Select the still image file to register (1 file at a time), and click the [Open] button.

- The content name entry screen is displayed.



8) Enter any [Content name], and click the [Enter] button.

- For [Content name], up to 24 characters in single byte can be entered.
- Even when the content name is different from the file name, the file name itself is not changed.
- The content is registered in the [Add content] screen.

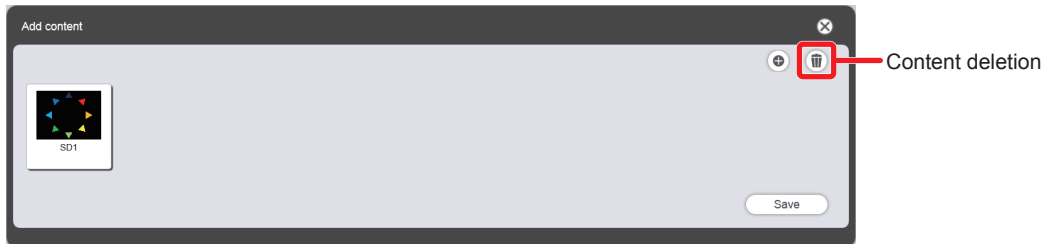

- To continue to add content, go back to Step 6), or to delete content from the [Add content] screen, go to Step 9), and to end adding content, proceed to Step 13).

9) To cancel addition of content, click  on the [Add content] screen.

- The mode changes to deletion mode.

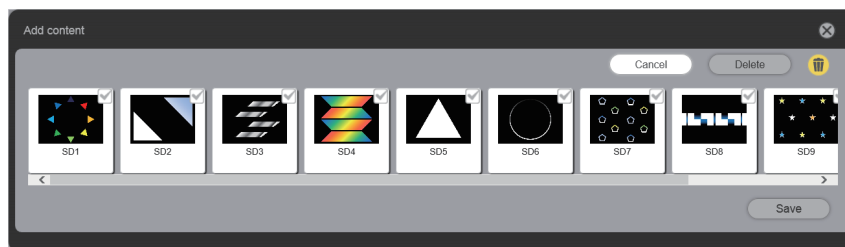

10) Select the content for which you want to cancel addition.

- You can select multiple contents.

11) Click the [Delete] button.

12) When the confirmation screen is displayed, click the [OK] button.

13) When addition of contents to register is complete, click the [Save] button.

- Added contents are registered in the SD card.

Note

- You can also register lighting patterns in the SD card as still image contents from the [Timetable] screen of [Schedule].
- To delete or change the registered lighting patterns, refer to “Deleting or changing registered patterns” (➔ page 196).

Deleting or changing registered patterns

Delete lighting patterns (still image contents) no longer required, or replace them with other patterns.

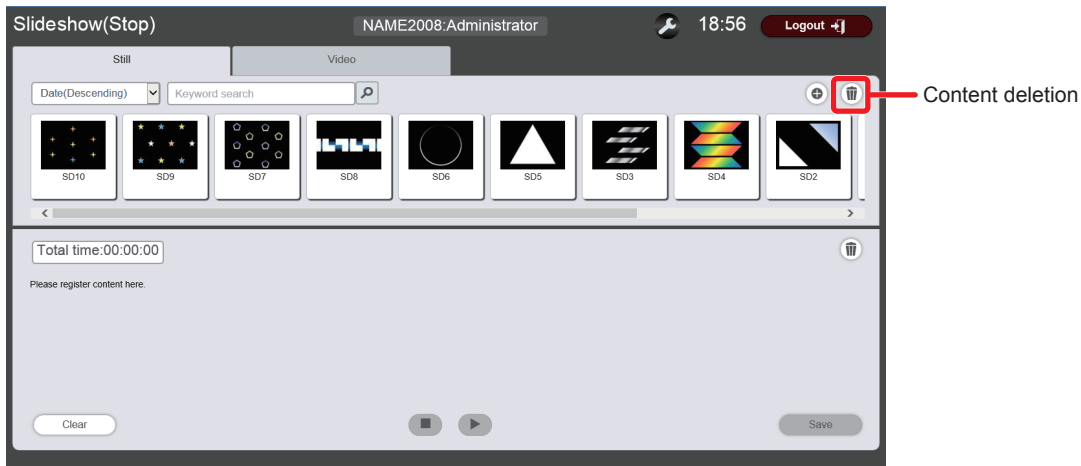

- 1) Click .
 - The mode changes to deletion mode.

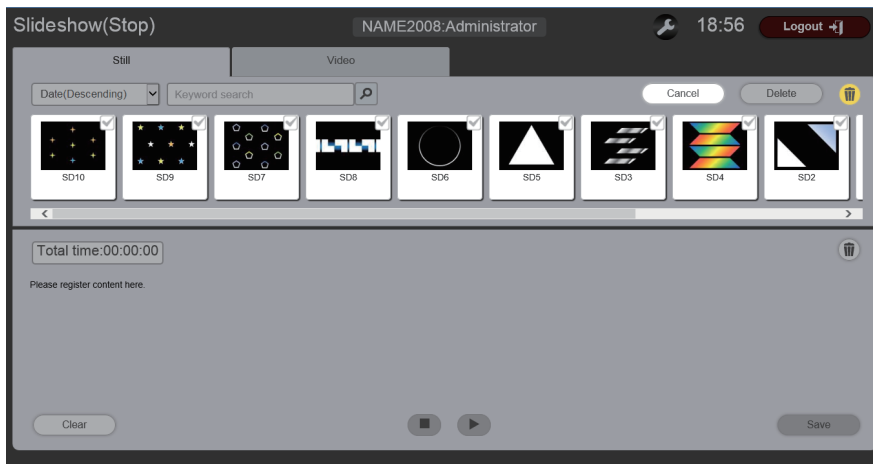

- 2) **Select the content you want to delete or replace.**
 - You can select multiple contents.
- 3) **Click the [Delete] button.**
- 4) **When the confirmation screen is displayed, click the [OK] button.**
 - The selected content is deleted from the SD card.
 - To replace it with another pattern, proceed to Step 5), or to just delete the pattern, proceed to Step 9).

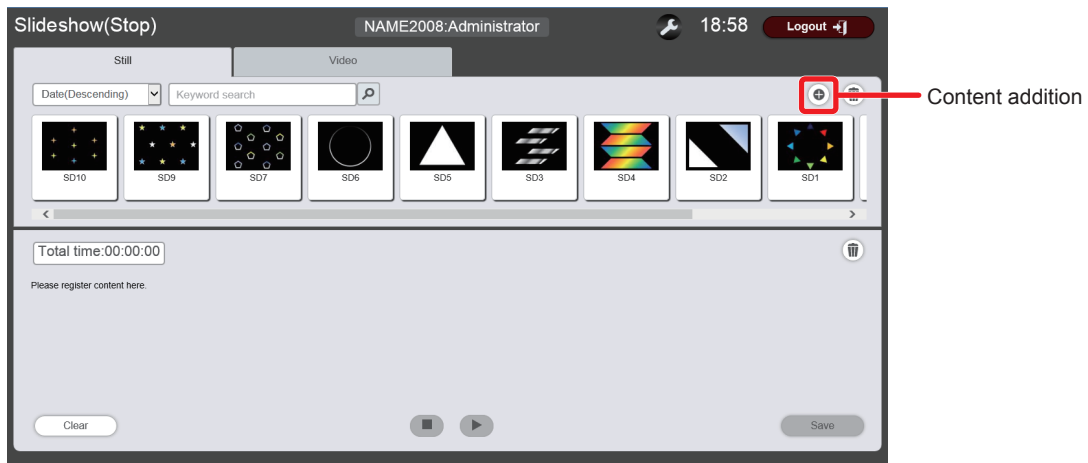

5) Click .

- The [Add content] screen is displayed.

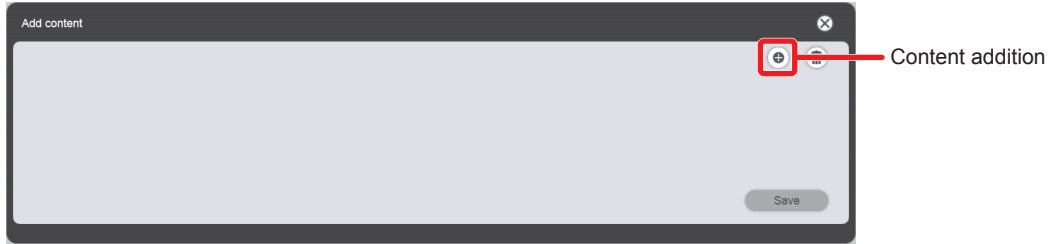

6) Click  on the [Add content] screen.

- The file selection screen is displayed.

7) Select the still image file of the pattern to be newly registered, and click the [Open] button.

- To replace it with another pattern, prepare a still image file having the same file name as the one deleted.
- The content name entry screen is displayed.



8) Enter any [Content name], and click the [Enter] button.

- The content is registered in the [Add content] screen.

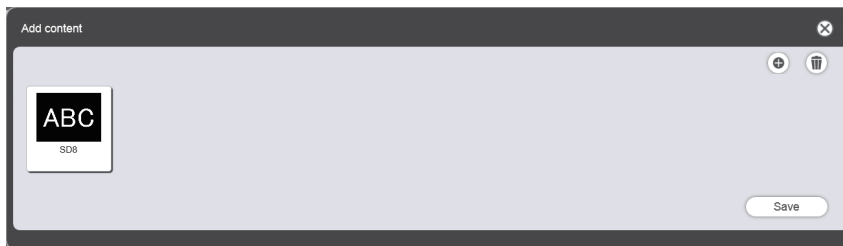

9) When addition of contents to register is complete, click the [Save] button.

- Added contents are registered in the SD card.

Note

- When the content to be deleted or replaced is registered in a schedule or slideshow, the content cannot be deleted.

[Effect]

The following table shows the special effects ([Effect]) which can be set to still image contents and used when changing the playback screen.

[Off]	Does not apply image effects.
[Random]	Applies image effects randomly.
[Wipe left]	Displays the image gradually from the left like wiping.
[Wipe right]	Displays the image gradually from the right like wiping.
[Wipe down]	Displays the image gradually from the top like wiping.
[Split]	Displays the image gradually from the center toward the left and right like wiping.
[Zoom out]	Displays the image gradually from the center towards the entire image.
[Fade]	Displays the entire image gradually.
[Blind]	Displays the image gradually like opening vertical blind.
[Checker wipe]	Displays the image gradually from the left to right in checkerboard patterns.
[Slide in]	Displays the next screen as if it slides in from the right to left.
[Slide out]	Displays the next screen by removing the current screen as if it slides out from the right to left.

Note

- The item name and the description for [Effect] indicate the operation when [PROJECTION METHOD] and [VERTICAL FLIP] is set so that the character in the projection can correctly be read.

[Color]

The following table shows the color settings to be reflected when playing image contents (still image/movie/ external input).

[High]	Makes the image bluish than the [Mid] setting.
[Mid]	Sets the color appropriate for the overall movie image.
[Low]	Makes the image reddish than the [Mid] setting.
[User P]	Reflects the [USER] setting*1 adjusted in the [PICTURE] menu → [COLOR TEMPERATURE].
[Super white]	Sets the brightness to maximum.
[Neutral]	Sets the color to neutral white.
[White]	Sets the color to white.
[Warm white]	Sets the color to warm white.
[Light]	Sets the color to light bulb color.
[Red]	Sets the color to red.
[Green]	Sets the color to green.
[Blue]	Sets the color to blue.
[Yellow]	Sets the color to yellow.
[Cyan]	Sets the color to cyan.
[Magenta]	Sets the color to magenta.
[User L1]	Reflects the [USER1] setting*2 adjusted in the [LIGHTING] menu → [COLOR SETTING].
[User L2]	Reflects the [USER2] setting*2 adjusted in the [LIGHTING] menu → [COLOR SETTING].
[User L3]	Reflects the [USER3] setting*2 adjusted in the [LIGHTING] menu → [COLOR SETTING].
[User L4]	Reflects the [USER4] setting*2 adjusted in the [LIGHTING] menu → [COLOR SETTING].
[User L5]	Reflects the [USER5] setting*2 adjusted in the [LIGHTING] menu → [COLOR SETTING].

*1 For the setting method, refer to “Adjusting desired white balance” (➡ page 65) which explains the [PICTURE] menu → [COLOR TEMPERATURE]. The setting adjusted after changing the input to Memory Viewer is reflected in still image/movie contents. In external input content, the setting adjusted after inputting still image signals in the HDMI input is reflected in the case of a still image (such as computer output), and the setting adjusted after inputting movie signals in the HDMI input is reflected in the case of a movie image (such as output of a blu-ray disc player). In order to reproduce the adjusted state of [USER], match the setting of the [PICTURE] menu → [PICTURE MODE] (➡ page 63) for signage input to [PICTURE MODE] of the input when the [USER] setting is adjusted.

*2 For the setting method, refer to “Setting a desired color” (➡ page 60) which explains the [LIGHTING] menu → [COLOR SETTING].

Chapter 6 Maintenance

This chapter describes troubleshooting and maintenance methods.

Light source/temperature indicators

When an indicator lights up

If a problem should occur inside the projector, the light source indicator <LIGHT>/temperature indicator <TEMP> will inform you by lighting or blinking. Check the status of the indicators and remedy the indicated problems as follows.

Attention

- Make sure to turn off the power before performing the procedure.
- Make sure to follow the procedure in “Turning off the projector” (➔ page 45) when switching off the projector.
- Check the status of the power supply with the power indicator <ON (G)/STANDBY (R)>. (➔ page 41)

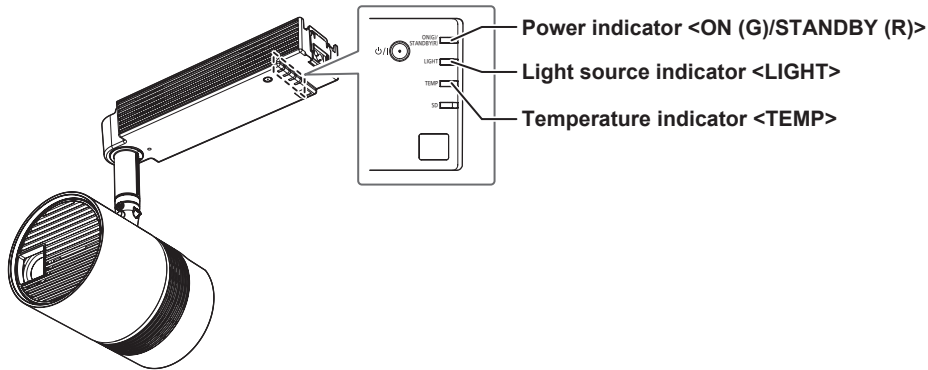

Light source indicator <LIGHT>

Indicator status	Lighting in red (projecting)	Blinking in red (2 times)	Blinking in red (3 times)
Status	The light source may not light properly.	The light source does not light or has suddenly turned off.	
Cause	—		
Solution	Turn off the power supply of the interior wiring or disconnect the plug of the power cord from the outlet, and then turn on the power again.		

Note

- If the light source indicator <LIGHT> is still lighting or blinking after taking above measures, ask your dealer for repair.

Temperature indicator <TEMP>

Indicator status	Lighting in red	Blinking in red (2 times)	Blinking in red (3 times)
Status	Internal temperature is high (warning).	Internal temperature is high (standby status).	The internal cooling fan is not running.
Cause	<ul style="list-style-type: none"> Is the air intake/exhaust port blocked? Is the room temperature high? Is [HIGH ALTITUDE MODE] set correctly? 		—
Solution	<ul style="list-style-type: none"> Remove any objects that are blocking the air intake/exhaust port. Install the projector in a location with the operating environment temperature between 0 °C (32 °F) and 40 °C (104 °F)*1. Make sure to set the [HIGH ALTITUDE MODE] to [HIGH1] when using the projector at altitudes between 1 000 m (3 281') and 2 000 m (6 562') above sea level, and set the [HIGH ALTITUDE MODE] (➔ page 71) to [HIGH2] when using the projector at altitude between 2 000 m (6 562') and 2 700 m (8 858'). Do not use the projector at high altitudes of 2 700 m (8 858') or higher above sea level. 		<ul style="list-style-type: none"> Turn off the power supply of the interior wiring or disconnect the plug of the power cord from the outlet, and then consult your dealer.

*1 The operating environment temperature should be between 0 °C (32 °F) and 35 °C (95 °F) when using the projector at elevations between 1 000 m (3 281') and 2 700 m (8 858') above sea level.

Note

- If the temperature indicator <TEMP> is still lighting or blinking after taking above measures, ask your dealer for repair.
- When using the projector at elevations lower than 1 000 m (3 281') above sea level, and the operating environment temperature becomes 35 °C (95 °F) or higher, the light output may be reduced to protect the projector. When using the projector at elevations between 1 000 m (3 281') and 2 700 m (8 858') above sea level, and the operating environment temperature becomes 30 °C (86 °F) or higher, the light output may be reduced to protect the projector.

Inspection and maintenance

Before maintaining the projector

Attention

- Make sure to turn off the power before maintaining the projector. (➔ pages 41, 45)
- When switching off the projector, make sure to follow the procedures in “Turning off the projector” (➔ page 45).

WARNING

Be sure to turn off the power of the track system before maintaining the projector.
Electric shocks can result.

Maintenance

Outer case

Wipe off dirt and dust with a soft, dry cloth.

- If the dirt is persistent, soak the cloth with water and wring it thoroughly before wiping. Dry off the projector with a dry cloth.
- Do not use benzene, thinner, or rubbing alcohol, other solvents, or household cleaners. Doing so may deteriorate the outer case.
- When using chemically treated dust cloths, follow the instructions written on its packaging.

Projection lens

Wipe off dirt and dust from the front surface of the lens with a soft clean cloth.

- Do not use a cloth that is fluffy, dusty, or soaked with oil/water.
- Since the lens is fragile, do not use excessive force when wiping the lens.

Attention

- The lens is made of glass. Hitting with a hard object or excessive force when wiping may scratch its surface. Handle with care.

Cleaning inside the projector

In certain environments, such as in dusty locations, dust accumulated around the intake and exhaust ports may degrade ventilation, cooling, and heat venting, and brightness may decrease as a result.

If brightness is noticeably reduced and the light source does not turn on, ask your dealer to clean inside the projector or replace the light source unit.

Inspection

Ask your dealer for inspection by an expert at least once every three years.

If the projector is used for prolonged periods without inspection, it may catch fire, cause an electric shock, or fall.

- For information about inspection costs, consult your dealer.

Attention

- Do not leave the product in place after use. Put it away immediately to prevent it falling in the event of an earthquake, etc.

Troubleshooting

Review the following points. For details, see the corresponding pages.

Problems	Points to be checked	Page
Power does not turn on.	<ul style="list-style-type: none"> Is the power supply of the interior wiring turned on? Is the plug of the power cord firmly inserted into the outlet? Is the outlet where the plug of the power cord connected supplying electricity? After executing [ALL USER DATA] in the [SETUP] menu → [INITIALIZE], is the power supply of the interior wiring turned back on or the plug of the power cord reconnected? Is the temperature indicator <TEMP> or the light source indicator <LIGHT> lighting or blinking? 	— — — 76 200
No image appears.	<ul style="list-style-type: none"> Are connections to external devices correctly performed? Is the input selection setting correct? Is the [BRIGHTNESS] adjustment setting at a minimum? Is the external device that is connected to the projector working properly? Is the AV mute function in use? 	38 51, 73 64 — 52
Image is fuzzy.	<ul style="list-style-type: none"> Is the lens focus set correctly? Is the projection distance appropriate? Is the lens dirty? 	48 35 22
Color is pale or grayish.	<ul style="list-style-type: none"> Are [COLOR] and [TINT] adjusted correctly? Is the external device connected to the projector adjusted correctly? 	64 38
Remote control does not respond.	<ul style="list-style-type: none"> Are the batteries depleted? Is the battery polarity (+, -) correct? Is there any obstruction between the remote control and the remote control signal receiver of the projector power supply unit? Is the remote control being used beyond its effective operation range? Are other forms of light, such as fluorescent light, affecting the projection? Is the ID number setting operation correct? 	— 28 25 25 25 52
Video from HDMI compatible device does not appear or it appears jumbled.	<ul style="list-style-type: none"> Is the HDMI cable connected securely? Turn the power of the projector and the external device off and on. Is a signal which is not compatible with the projector being input? 	38 — 215
No audio is coming from the HDMI compatible device.	<ul style="list-style-type: none"> Set audio of the external device to Linear PCM. 	—
Operation noise occurs during standby	<ul style="list-style-type: none"> When the [SETUP] menu → [ECO MANAGEMENT] → [STANDBY MODE] is set to [NORMAL], the internal cooling fan may operate even during standby. 	72

Attention

- If problems persist even after checking the preceding points, consult your dealer.

FAQ

Refer to the following when you have problems with the wireless LAN connection.

The connection with the wireless LAN is lost.

- Under certain reception conditions, the image may be disrupted. In such a case, try the following.
 - Move the device connected over the wireless LAN closer to the projector.
 - Install the projector away from devices that emit electromagnetic radiation, such as microwave ovens, gaming consoles. If it does not improve, refrain from using other devices that emit electromagnetic radiation.
 - The bandwidth of the wireless may not be sufficient when multiple wireless devices are connected to a single router. Turn off or refrain from using other devices.
 - Where possible, try not use in a location where excessive static electricity is generated.
- When the connection with wireless LAN is not possible, set the [NETWORK] menu → [WIRELESS LAN] (➔ page 78) to [DISABLE], and perform the wireless LAN connection again. The resume process of the wireless module will operate.

Also, when there is a problem with the Miracast connection, refer to the following.

Connection with the Miracast is not possible.

- Is the [NETWORK] menu → [WIRELESS LAN] (➔ page 78) set to [DISABLE]?
- Is the input of the projector set to [Miracast]?
- Check the settings of the Miracast compatible device. Refer to the operating instructions of the Miracast compatible device for the connection method with the Miracast.
- Is there any obstacle between the Miracast compatible device and the projector? Also, is the Miracast compatible device too far away from the projector? Remove the obstacle and bring the Miracast compatible device closer.
- The connection information may be present in the “Paired devices” column of the Miracast compatible device, but it is not possible to reconnect from that screen. Connect instead from the list of connectable devices.
- Depending on the status of the Miracast compatible device in use, it may not connect correctly.

The connection is suddenly lost and image is not updated.

- If a problem occurs, such as the Miracast standby screen not being displayed, normal sound not being output, or not being able to connect, perform the following to restore.
 - Set [STANDBY MODE] in the [SETUP] menu → [ECO MANAGEMENT] (➔ page 72) to [ECO], and turn off/on the projector. (If it is already set to [ECO], the changing operation of [STANDBY MODE] is not necessary.)
 - Turn off the power, and then turn on the power supply of the interior wiring again or reconnect the plug of the power cord to the outlet.
 - Turn the Miracast compatible device and the projector off and then on again.

Image of the Miracast is disrupted.

- Set the [NETWORK] menu → [WIRELESS LAN] (➔ page 78) to [S-DIRECT] or [M-DIRECT].
- The connection of the Miracast is using wireless, so the image may be disrupted depending on the radio environment. In such a case, try the following.
 - Bring the Miracast compatible device closer to the projector.
 - Install the projector away from devices that emit electromagnetic radiation, such as microwave ovens, gaming consoles. If it does not improve, refrain from using other devices that emit electromagnetic radiation.
 - The bandwidth of the wireless may not be sufficient when multiple wireless devices are connected to a single router. Turn off or refrain from using other devices.
- The image may be disrupted when there is a problem with the content itself, so check the content.
- The image of the Miracast may be disrupted because of type of Miracast compatible device in use. In this case the problem is the processing performance or wireless transmission performance of the Miracast compatible device, and not a malfunction of the projector.

The connection was lost when no operation was performed after connecting with the Miracast.

- The connection may be disconnected after specific time due to the type of Miracast compatible device in use. Check the power save setting, etc., of the device.
- This may be improved by updating the wireless driver or the firmware. Contact the support service of the manufacturer of the device in use.

Other

- Depending on the Miracast compatible device in use, a confirmation screen for reconnection with connection name of “from UNKNOWN” may be displayed. In this case, however, reconnection will not be possible, so select CANCEL.
- Depending on the Miracast compatible device in use, it may be required to remove the device during connecting. In such a case, delete the device following the instruction of the device.

Chapter 7 Appendix

This chapter describes specifications and after-sales service for the projector.

Technical information

Using the PJLink protocol

The projector supports PJLink Class 1. This means a computer can use the PJLink protocol to operate the projector or query its status.

Control commands

The following table lists the PJLink protocol commands that can be used to control the projector.

• x characters in tables are non-specific characters.

Command	Control details	Parameter / return string	Remark		
POWR	Power supply control	0	Standby		
		1	Power on		
POWR?	Power supply status query	0	Standby condition		
		1	Power on condition		
		2	Preparing for switching off the projector		
INPT	Input selection	31	HDMI		
		41	MEMORY VIEWER		
		42	SIGNAGE		
INPT?	Input selection query	51	Panasonic APPLICATION		
		52	Miracast		
		53	LIGHTING		
AVMT	AV mute control	30	AV mute function off		
AVMT?	AV mute function query	31	AV mute function on		
ERST?	Error status query	xxxxxx	1st byte	Indicates fan errors, and returns 0 - 2.	<ul style="list-style-type: none"> • 0 = No error is detected • 1 = Warning • 2 = Error
			2nd byte	Indicates light source errors, and returns 0 - 2.	
			3rd byte	Indicates temperature errors, and returns 0 - 2.	
			4th byte	Indicates cover open errors, and returns 0 or 2.	
			5th byte	Returns 0.	
			6th byte	Indicates other errors, and returns 0 - 2.	
LAMP?	Light source status query	ERR1	Undefined command		
NAME?	Projector name query	xxxxx	Returns the name set in [PROJECTOR NAME] of [NETWORK].		
INF1?	Manufacturer name query	Panasonic	Returns manufacturer name.		
INF2?	Model name query	JW130FBE/JW130FWE	Returns model name.		
INF0?	Other information queries	xxxxx	Returns information such as version number.		
CLSS?	Class information query	1	Returns class for PJLink.		

PJLink security authentication

The password used for PJLink is the same as that of the password set for web control.

When using the projector without security authentication, do not set a password for web control.

- For specifications related to PJLink, refer to the website of Japan Business Machine and Information System Industries Association.

URL <http://pjlink.jbmia.or.jp/english/>

Using Art-Net function

Since projector supports the Art-Net function, the projector settings can be performed via the Art-Net protocol on the DMX controller or using application software.

Channel definition

The following table lists the channel definitions used for controlling the projector with the Art-Net function.

Channel	Control details	Performance	Parameter	Remark
1	Light volume adjustment	100 %	0	Can be set in 256 steps between 100 % and 0 %.
		
		0 %	255	
2	Input/mode selection	No operation	0-7	—
		HDMI	8-15	
		Lighting	16-23	
		No operation	24-255	
6	Lens focus	Focus adjustment (-) fast	0-31	—
		Focus adjustment (-) moderate	32-63	
		Focus adjustment (-) slow	64-95	
		No operation	96-159	
		Focus adjustment (+) slow	160-191	
		Focus adjustment (+) moderate	192-223	
		Focus adjustment (+) fast	224-255	
7	Lens zoom	Zoom adjustment (-) fast	0-31	—
		Zoom adjustment (-) moderate	32-63	
		Zoom adjustment (-) slow	64-95	
		No operation	96-159	
		Zoom adjustment (+) slow	160-191	
		Zoom adjust (+) moderate	192-223	
		Zoom adjustment (+) fast	224-255	
8	Power supply control	Power standby	0-63	—
		No operation	64-191	
		Power on	192-255	
11	Lock	Operation not available	0-127	When "Operation not available" is set, operations of all channels become unacceptable.
		Operation available	128-255	

Note

- If the projector is operated with the remote control or by the control command while controlling the projector using the Art-Net function, the setting of the DMX controller and the computer application may be different from the projector status. In this case, set "Lock" of channel 11 to "Operation not available" and then set back to "Operation available" so that the controls of all channels are applied to the projector.

Control commands via LAN

When the projector is connected to a computer via a LAN, the computer can use control commands to operate the projector and query its status.

When web control administrator rights password is set (Protect mode)

Connecting

- 1) Obtain the IP address and port number (Initial set value = 1024) of the projector and request a connection to the projector.

- Both the IP address and the port number can be obtained from the menu screen of the projector.

IP address	Obtain from the main menu → [NETWORK] → [NETWORK STATUS]
Port number	Obtain from the main menu → [NETWORK] → [NETWORK CONTROL] → [COMMAND PORT]

- 2) Check the response from the projector.

	Data section	Blank	Mode	Blank	Random number section	Termination symbol
Command example	"NTCONTROL" (ASCII string)	' '	'1'	' '	"zzzzzzzz" (ASCII code hex number)	(CR) 0x0d
Data length	9 bytes	1 byte	1 byte	1 byte	8 bytes	1 byte

- Mode: 1 = Protect mode

- 3) Generate a 32-byte hash value from the following data using MD5 algorithm.

- "xxxxxx:yyyyy:zzzzzzzz"

xxxxxx	Administrator rights user name for the web control (default user name is "admin1")
yyyyy	Password of above administrator rights user (default password is "panasonic")
zzzzzzzz	8-byte random number obtained in Step 2)

Command transmission method

Transmit using the following command formats.

■ Transmitted data

	Header			Data section	Termination symbol
Command example	Hash value (Refer to "Connecting" above)	'0'	'0'	Control command (ASCII string)	(CR) 0x0d
Data length	32 bytes	1 byte	1 byte	Undefined length	1 byte

■ Received data

	Header		Data section	Termination symbol
Command example	'0'	'0'	Control command (ASCII string)	(CR) 0x0d
Data length	1 byte	1 byte	Undefined length	1 byte

■ Error response

	String	Details	Termination symbol
Message	"ERR1"	Undefined control command	(CR) 0x0d
	"ERR2"	Out of parameter range	
	"ERR3"	Busy state or no-acceptable period	
	"ERR4"	Timeout or no-acceptable period	
	"ERR5"	Wrong data length	
	"ERRA"	Password mismatch	
Data length	4 bytes	—	1 byte

When web control administrator rights password is not set (Non-protect mode)

Connecting

1) Obtain the IP address and port number (Initial set value = 1024) of the projector and request a connection to the projector.

- Both the IP address and the port number can be obtained from the menu screen of the projector.

IP address	Obtain from the main menu → [NETWORK] → [NETWORK STATUS]
Port number	Obtain from the main menu → [NETWORK] → [NETWORK CONTROL] → [COMMAND PORT]

2) Check the response from the projector.

	Data section	Blank	Mode	Termination symbol
Command example	"NTCONTROL" (ASCII string)	' '	'0' 0x30	(CR) 0x0d
Data length	9 bytes	1 byte	1 byte	1 byte

- Mode: 0 = Non-protect mode

Command transmission method

Transmit using the following command formats.

■ Transmitted data

	Header		Data section	Termination symbol
Command example	'0' 0x30	'0' 0x30	Control command (ASCII string)	(CR) 0x0d
Data length	1 byte	1 byte	Undefined length	1 byte

■ Received data

	Header		Data section	Termination symbol
Command example	'0' 0x30	'0' 0x30	Control command (ASCII string)	(CR) 0x0d
Data length	1 byte	1 byte	Undefined length	1 byte

■ Error response

	String	Details	Termination symbol
Message	"ERR1"	Undefined control command	(CR) 0x0d
	"ERR2"	Out of parameter range	
	"ERR3"	Busy state or no-acceptable period	
	"ERR4"	Timeout or no-acceptable period	
	"ERR5"	Wrong data length	
	"ERRA"	Password mismatch	
Data length	4 bytes	—	1 byte

Control command

The following table lists the commands that can be used to control the projector using a computer.

■ Projector control command/query command

Command	Details	Parameter/response string	Remark (parameter)
PON	Power on	—	To check if the power is on, use the "Power supply status query" command.
POF	Power standby	—	
QPW	Power supply status query	000 001	STANDBY status Power on condition
IIS	Input/mode selection	HD1 MV1 MC1 PA1 SI1 LI1	HDMI MEMORY VIEWER Miracast Panasonic APPLICATION SIGNAGE LIGHTING
OLP	Light source power setting	0	NORMAL
QLP	Light source power setting query	1	ECO
QST	Runtime query	00000 - 99999	In hours
OSH	AV mute	0	AV mute function off
QSH	AV mute function query	1	AV mute function on
AUU	Volume up	—	—
AUD	Volume down	—	—

Glossary of network terms

Term	Description
Access point	This is a signal station for relaying signals between the wireless LAN and the computer. A computer connected to the access point can communicate via the network connected to the access point.
AES	Abbreviation for Advanced Encryption Standard. The next-generation encryption method of US government standardized by the National Institute of Standards and Technology (NIST). AES: Advanced Encryption System
Default gateway	This is equipment used to connect to a network using a different network standard from the network in use. It allows the connection between the networks by adjusting for the differences in the communication protocols. The data is sent to the host set in the default gateway when the gateway is not set in the IP address of the destination.
DHCP	Abbreviation for Dynamic Host Configuration Protocol. A protocol to automatically assign an IP address to the connected device. An IP address is automatically assigned to the device connected if a device with the DHCP server function is within the LAN.
EAP	Abbreviation for PPP Extensible Authentication Protocol. An authentication protocol expanding the PPP used during the user authentication by remote access. MD5, TLS, and S/Key are supported as the authentication method. This is the protocol supported by the wireless LAN authentication standard IEEE802.1X, and there are formats such as EAP-TLS/EAP-TTLS/EAPLEAP/EAP-PEAP/EAP-MD5.
EAP-FAST	Abbreviation for EAP-Flexible Authentication via Secure Tunneling. One of the wireless authentication methods supporting the IEEE802.1X. It enhances security by tunneling of the authentication process using a secret key encryption method not requiring a digital authentication, and mutually authenticating the tunnel. Proprietary method of Cisco Systems Inc.
EAP-TTLS	Abbreviation for EAP-Tunneled Transport Layer Security. One of the wireless authentication methods supporting the IEEE802.1X. An authentication server electronic certificate, client will perform mutual authentication by an ID/password. Authentication process will be tunneled. Developed by the Funk Software of US.
GTC (EAP-GTC)	Abbreviation for EAP-Generic Token Card. One of the wireless authentication methods supporting the IEEE802.1X. Authentication is performed using the ID password. A security token is used as the password.
IP address	IP (Internet Protocol) is a protocol to transmit data, and the IP address is the destination (address) when transmitting data on a network. The same IP address cannot be used within the same LAN.
LAN	Abbreviation for Local Area Network. This is a network with a relatively small range such as inside a company.
MAC address	An ID number unique to each network adapter. A unique number is assigned to network adapters throughout the world, and data is sent and received between the adapters based on this. This ID number is a combination of the unique number for the manufacturer managed and assigned by IEEE and the number assigned by each manufacturer to their adapter.
MD5 (EAP-MD5)	Abbreviation for EAP-Message digest algorithm 5. One of the wireless authentication methods supporting the IEEE802.1X. Authentication is performed using the ID password. Password is sent encrypted with the challenge & response format.
MS-CHAPv2 (EAP-MS-CHAPv2)	Abbreviation for EAP-Microsoft Challenge Handshake Authentication Protocol v2. One of the wireless authentication methods supporting the IEEE802.1X. Mutual authentication is performed using one way encryption password.
Open System/open	One of the wireless authentication methods using public key encryption.
PEAP	Abbreviation for EAP-Protected EAP. One of the wireless authentication methods supporting the IEEE802.1X. An authentication server electronic certificate, client will perform mutual authentication by an ID/ password.
RADIUS server	RADIUS is an abbreviation of Remote Access Dial In User authentication Service, and it is a protocol used for authentication in a network such as wireless LAN. The authentication server supporting that protocol is called RADIUS server. It is not required to register the user information individually to each device even when there are multiple network devices by using the RADIUS server, allowing the integrated management of many network devices and users.
Shared Key/share	One of the wireless authentication methods using the secret key encryption, and it is a method to authenticate using the encryption key set in the WEP. This is the encryption method using same key for both encryption and decryption, and it is also called as "shared key encryption" or "common key encryption".
SSID	Abbreviation for Service Set ID. With the wireless LAN, it is necessary to set the identification code called as SSID to differentiate if it is the access point to communicate. It may be displayed as "ESSID" or "Network name" in the wireless LAN adapter depending on the manufacturer.
Subnet mask	The network may manage the large network by dividing it to multiple smaller network called as subnet. In such case, the value to delimit the IP address is called as subnet mask.
TKIP	Abbreviation for Temporal Key Integrity Protocol. This is an encryption protocol with enhanced security protection than the WEP by changing the encryption key every specified time.
WEP	Abbreviation for Wired Equivalent Privacy. This is the method to encrypt the data to communicate. By creating an encryption key and only notifying it to the person to communicate, the communication data will not be decrypted by a third party.

Chapter 7 Appendix — Glossary of network terms

Term	Description
WPA-EAP WPA2-EAP	A standard of encryption method for wireless LAN. This is an encryption method for corporation, and encryption is performed using an external server.
WPA-PSK WPA2-PSK	A standard of encryption method for wireless LAN. This is advanced security than the WEP, and it has functions such as user authentication function and TKIP (encryption protocol) that will automatically change the encryption key every specified time. Also, this authentication method does not need an authentication server.

Specifications

The specifications of the projector are as follows.

Model No.		PT-JW130FBE/PT-JW130FWE
Power supply		100 V - 240 V ~ (100 V - 240 V alternating current), 50 Hz/60 Hz
Power consumption		125 W (1.4 A - 0.6 A) In standby mode (when [STANDBY MODE] is set to [ECO]): 0.5 W ^{*1} In standby mode (when [STANDBY MODE] is set to [NETWORK]): 6 W ^{*2} In standby mode (when [STANDBY MODE] is set to [NORMAL]): 11 W
DLP chip	Size	11.4 mm (0.45") (aspect ratio 16:10)
	Display system	1-unit DLP chip, DLP type
	Number of pixels	1 039 680 pixels (WXGA comparable)
Lens	Electric zoom	1.5 to 3.3:1
	Electric focus	F = 2.0 to 2.7 f = 15.2 mm to 32.7 mm
Light source		Laser diode
Light output ^{*3}		1 000 lm (ANSI)
Contrast ratio ^{*3}		1 000:1
Projected image size		0.76 m (30") to 5.08 m (200")
Screen aspect ratio		16:10
Projection method		[FRONT]/[REAR] (On/off of vertical flip can be set with [VERTICAL FLIP])
Card slot		SD card slot ^{*4} x 1 (supports SDHC memory card)
Outer case		Molded plastic
Outer color		PT-JW130FBE: Black, PT-JW130FWE: White
Weight		3.3 kg (7.3 lbs.)
Noise level ^{*3}	When installing on the ceiling	When [LIGHT POWER] is set to [NORMAL]: 36 dB When [LIGHT POWER] is set to [ECO]: 30 dB
	When standing on the floor	When [LIGHT POWER] is set to [NORMAL]: 37 dB When [LIGHT POWER] is set to [ECO]: 32 dB
Operating environment	Temperature ^{*5}	0 °C (32 °F) to 40 °C (104 °F)
	Humidity	10 % to 80 % (no condensation)
Remote control	Power supply	DC 3 V (AAA/R03 or AAA/LR03 battery x 2)
	Operating range	Within approx. 7 m (22'11") (when operated directly in front of signal receiver)
	Weight	63 g (2.2 ozs.) (including batteries)
	Dimensions	Width: 44 mm (1-23/32"), Height: 105 mm (4-1/8"), Depth: 20.5 mm (13/16")

*1 When the [SETUP] menu → [ECO MANAGEMENT] → [STANDBY MODE] is set to [ECO], the network function (both wireless LAN and wired LAN) cannot be used in standby mode.

*2 When the [SETUP] menu → [ECO MANAGEMENT] → [STANDBY MODE] is set to [NETWORK], the network function while in standby mode is restricted to the projector operations via wired LAN using the Wake on LAN function.

*3 Measurement, measuring conditions and method of notation all comply with ISO21118 international standards.

*4 Operations of the Panasonic SD memory card up to capacity of 2 GB and Panasonic SDHC memory card up to capacity of 32 GB are confirmed.

*5 The operating environment temperature should be between 0 °C (32 °F) and 35 °C (95 °F) when using the projector at elevations between 1 000 m (3 281') and 2 700 m (8 858') above sea level.

When using the projector at elevations lower than 1 000 m (3 281') above sea level, and the operating environment temperature becomes 35 °C (95 °F) or higher, the light output may be reduced to protect the projector. When using the projector at elevations between 1 000 m (3 281') and 2 700 m (8 858') above sea level, and the operating environment temperature becomes 30 °C (86 °F) or higher, the light output may be reduced to protect the projector.

■ Applicable scanning frequency/terminal/wireless LAN

Model No.		PT-JW130FBE/PT-JW130FWE
Applicable scanning frequency*1	HDMI signal	525p (480p), 625p (576p), 750 (720)/60p, 750 (720)/50p, 1125 (1080)/60p, 1125 (1080)/50p
		VGA60, SVGA56, SVGA60, XGA60, SXGA60, 1280 x 720/50, 1280 x 720/60, 1280 x 768/50, 1280 x 768/60, 1280 x 800/50, 1280 x 800/60, 1600 x 900/50, 1600 x 900/60
Terminal	<HDMI IN> terminal	1 set, HDMI 19 pins, HDCP compatible Audio signal: Linear PCM (Sampling frequency: 48 kHz/44.1 kHz/32 kHz)
	<AUDIO OUT> terminal	1 set, M3 stereo mini jack (monitor output, stereo compatible) 0 V [rms] to 2.0 V [rms] (variable), output impedance 2.2 kΩ or less
	<LAN> terminal	1 set, RJ-45, for network connection, PLink compatible, 10Base-T/100Base-TX
	<DC OUT> terminal	USB connector (type A) x 1, for power supply (DC 5 V, maximum 900 mA)
Wireless LAN	Compliance standards	IEEE802.11b/g/n, IEEE802.11a/n (wireless LAN standard protocol)
	Used wireless channel	Passive scanning: 2.412 GHz - 2.472 GHz 5.180 GHz - 5.825 GHz
	Communication distance	Approx. 30 m (98'5") (depends on the usage environment)

*1 Refer to "List of compatible signals" (➡ page 215) for details of the types of video signals that can be used with the projector.

Note

- The model numbers of accessories, etc. are subject to change without prior notice.

Dimensions

Unit: mm

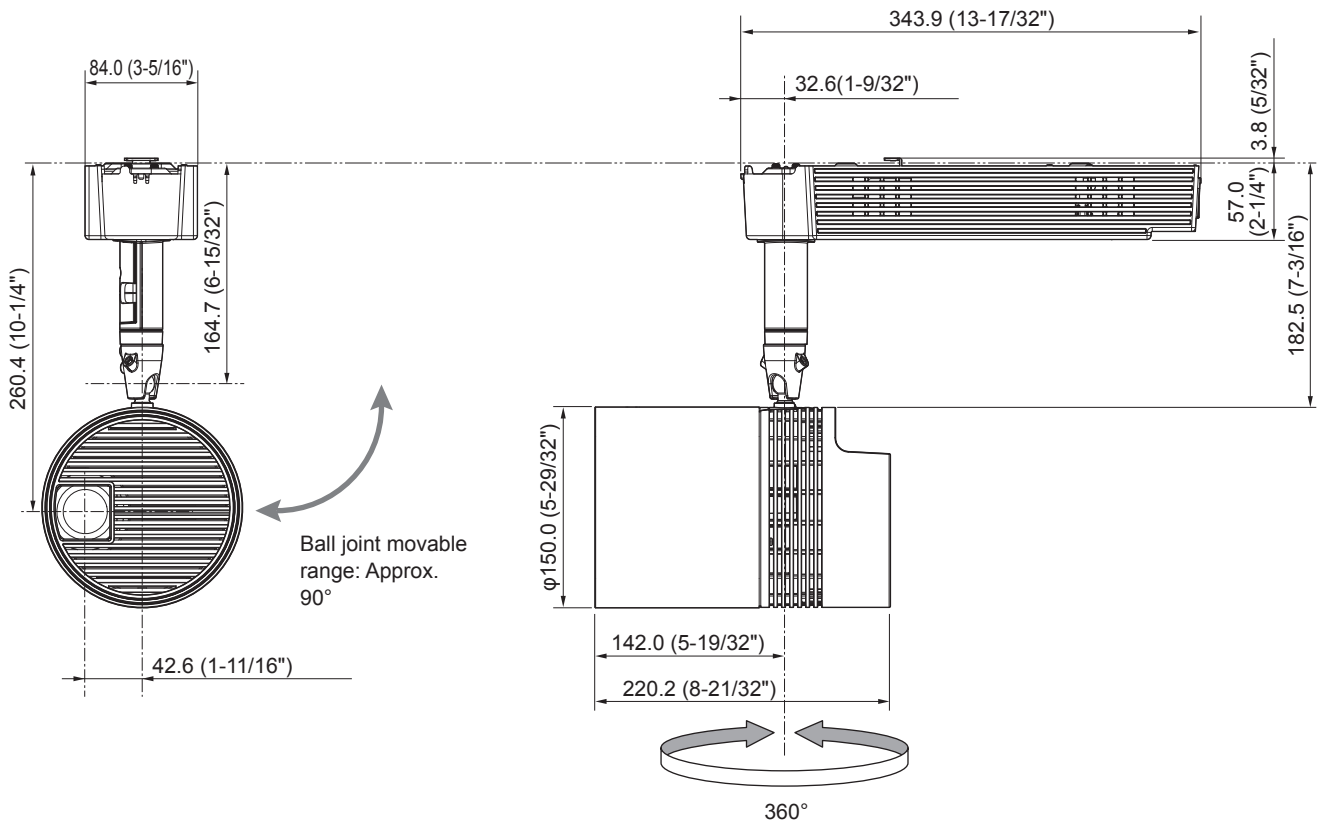

* Actual dimensions may differ depending on the product.

List of compatible signals

The following table specifies the HDMI input video signal that the projector can project.

Mode	Resolution (Dots)	Scanning freq.		Dot clock freq. (MHz)	Plug and play*1
		Horizontal (kHz)	Vertical (Hz)		
525p (480p)	720 x 480	31.5	59.9	27.0	✓
625p (576p)	720 x 576	31.3	50.0	27.0	✓
750 (720)/60p	1 280 x 720	45.0	60.0	74.3	✓
750 (720)/50p	1 280 x 720	37.5	50.0	74.3	✓
1125 (1080)/60p	1 920 x 1 080	67.5	60.0	148.5	✓
1125 (1080)/50p	1 920 x 1 080	56.3	50.0	148.5	✓
VGA	640 x 480	31.5	59.9	25.2	✓
SVGA	800 x 600	35.2	56.3	36.0	✓
	800 x 600	37.9	60.3	40.0	✓
XGA	1 024 x 768	48.4	60.0	65.0	✓
SXGA	1 280 x 1 024	64.0	60.0	108.0	✓
1280 x 720	1 280 x 720	37.1	49.8	60.5	—
	1 280 x 720	44.8	59.9	74.5	—
1280 x 768	1 280 x 768	39.6	49.9	65.3	—
	1 280 x 768	47.8	59.9	79.5	—
1280 x 800	1 280 x 800	41.3	50.0	68.0	—
	1 280 x 800	49.7	59.8	83.5	✓
1600 x 900	1 600 x 900	46.4	49.9	96.5	—
	1 600 x 900	56.0	59.9	118.3	—

*1 Signals with a ✓ in the Plug and play columns are signals described in EDID (extended display identification data) of the projector. A signal, which has no ✓ in the Plug and play columns but has an entry in the Format column, can be input. For signals without a ✓ in the Plug and play columns, there are instances when resolution cannot be selected on the computer even though the projector supports them.

Note

- The picture quality may degrade due to image process depending on the input signal.

Index

- A**
- [Access error log] 109
 - Accessing from the web browser 105
 - Accessories 23
 - [Adjust clock] 114
 - Adjusting the volume 52
 - [Advanced control] 111
 - Air exhaust port 26
 - Air intake port 26
 - [Art-Net] 83
 - Art-Net 207
 - [ASPECT] 68
 - Audio compression codec 93, 127
 - Audio format 93, 127
 - <AUDIO OUT> terminal 26
 - [AUDIO SETTING] 73
 - [Authentication set up] 118
 - [AV MUTE] 88
 - <AV MUTE> button 25, 52
 - AV mute function 52
- B**
- [Basic control] 110
 - [BRIGHTNESS] 64
- C**
- Cautions on use 21
 - Cautions when installing 17
 - [Color] 198
 - [COLOR] 64
 - [COLOR SETTING] 60
 - [COLOR TEMPERATURE] 64
 - Connecting via wireless LAN 102
 - Connection 38
 - Content list 145
 - Content Manager 127
 - [CONTRAST] 63
 - Control commands via LAN 207
 - [CORNER CORRECTION] 69
 - [Crestron Connected(TM)] 123
- D**
- [DATE AND TIME] 74
 - <DEFAULT> button 25, 56
 - Dimensions 214
 - [DIMMER] 62, 65
 - Display language 58, 89
 - [DISPLAY OPTION] 58, 87
 - Disposal 22
- E**
- [ECO MANAGEMENT] 71
 - [Effect] 197
 - [E-mail error log] 109
 - [E-mail set up] 116
 - <ENTER> button 25
 - Error information 108
 - Extension 93, 127
- F**
- FAQ 204
 - <FOCUS> button 25, 48
- G**
- Glossary of network terms 211
- H**
- <HDMI> button 25, 51
 - [HDMI IN] 87
 - [HIGH ALTITUDE MODE] 71
- I**
- <ID ALL> button 25, 52
 - <ID SET> button 25, 52
 - [INITIALIZE] 76
 - Initial setting 42
 - [INITIAL STARTUP] 72
 - Inspection 202
 - Installation 31
 - Interruption playback 167
- K**
- [KEYSTONE] 69
- L**
- [LIGHTING] 57, 60
 - [Lighting control] 111
 - Lighting mode 47
 - Lighting pattern 193
- <LIGHTING/PROJECTOR> button 25, 51
 - Light source indicator 200
 - List of compatible signals 215
 - [LIVE MODE CUT IN] 81
 - [LOAD ALL USER DATA] 75
- M**
- Main menu 56
 - Maintenance 202
 - [M-DIRECT] 78
 - [MEMORY VIEWER] 57, 66
 - <MEMORY VIEWER> button 25, 51
 - Memory Viewer function 93
 - <MENU> button 25
 - Menu item 57
 - <Miracast> button 25, 51
 - Miracast function 126
 - [MULTI-LIVE] 82
- N**
- Navigating through the menu 55
 - [NETWORK] 58, 77
 - [Network config] 112
 - [NETWORK CONTROL] 81
 - [NETWORK ID] 83
 - [Network status] 109
 - [NETWORK STATUS] 83
 - Number (<1> - <6>) buttons 25
- O**
- [ON-SCREEN DISPLAY] 87
 - On-screen menu 55
- P**
- <Panasonic APP> button 25, 51
 - [Panasonic APPLICATION] 81
 - [PASSWORD] 82
 - [PASSWORD CHANGE] 82
 - [PATTERN] 60
 - [PICTURE] 57, 63
 - [PICTURE MODE] 63
 - [Ping test] 115
 - PJLink protocol 206
 - Playback history 174
 - Playlist 149
 - [Port set up] 118
 - Power button
 - Projector body 26
 - Remote control 25
 - Power indicator 41
 - Precautions for use 17
 - Projecting 47
 - [PROJECTION METHOD] 31, 68
 - [PROJECTOR ID] 68
 - Projector mode 47
 - [PROJECTOR NAME] 77
- R**
- Read this first! 4
 - Remote control 25
 - Remote control operations 51
 - Resetting to the factory default 56
 - <RETURN> button 25
- S**
- [SAVE ALL USER DATA] 75
 - [Schedule] 131
 - Security 20
 - [SECURITY] 58, 90
 - [SECURITY PASSWORD] 90
 - [SECURITY PASSWORD CHANGE] 90
 - [SERVICE PASSWORD] 76
 - Setting the remote control ID numbers 52
 - Setting up 36
 - [SETUP] 58, 68
 - [SIGNAGE] 70
 - <SIGNAGE> button 25, 51
 - Signage setting 128
 - [Slideshow] 185
 - Specifications 213
 - [STARTUP INPUT SELECT] 73
 - [STATUS] 74
 - Switching the input 51
- T**
- Temperature indicator 201
 - [TEST PATTERN] 59, 91
 - Timetable 133
 - [TINT] 64
- Troubleshooting 203
- Turning off the projector 45
 - Turning on the projector 42
- V**
- [VERTICAL FLIP] 68
 - Video compression codec 93, 127
 - Video format 93, 127
 - <VOL+>/<VOL-> button 25, 52
- W**
- [WIRED LAN] 77
 - [WIRELESS LAN] 78
- Z**
- <ZOOM> button 25, 48

Information for Users on Collection and Disposal of Old Equipment and used Batteries



These symbols on the products, packaging, and/or accompanying documents mean that used electrical and electronic products and batteries should not be mixed with general household waste. For proper treatment, recovery and recycling of old products and used batteries, please take them to applicable collection points, in accordance with your national legislation and the Directives 2002/96/EC and 2006/66/EC.

By disposing of these products and batteries correctly, you will help to save valuable resources and prevent any potential negative effects on human health and the environment which could otherwise arise from inappropriate waste handling.



For more information about collection and recycling of old products and batteries, please contact your local municipality, your waste disposal service or the point of sale where you purchased the items.

Penalties may be applicable for incorrect disposal of this waste, in accordance with national legislation.



For business users in the European Union

If you wish to discard electrical and electronic equipment, please contact your dealer or supplier for further information.

Information on Disposal in other Countries outside the European Union

These symbols are only valid in the European Union. If you wish to discard these items, please contact your local authorities or dealer and ask for the correct method of disposal.

Note for the battery symbol (bottom two symbol examples):

This symbol might be used in combination with a chemical symbol. In this case it complies with the requirement set by the Directive for the chemical involved.

Panasonic Corporation

Web Site : <http://panasonic.net/avc/projector/>

© Panasonic Corporation 2015

M0215NN1076 -YI