

# Panasonic

BUSINESS

# AK-UC4000

4K Studio Camera

A High End System Camera  
Setting a New Standard in  
4K/HD HDR Acquisition



12GSDI

TICO

MoIP

# A 4K studio camera with high video quality. Compatible with a 2/3 lens mount and contains a newly developed large 4.4K sensor.

This camera offers the high video quality that is only possible with a large sensor, along with a wide range of 4K acquisition with the latest functions such as HDR (HLG), BT.2020 and high-speed shooting\*<sup>1</sup>. The camera keeps up with diversifying systems with features such as 12G-SDI, TICO\*<sup>2</sup>, over SDI (4K over 3G-SDI) output and MoIP\*<sup>3</sup>, making it suitable not only for studio production but for a wide range of operations such as sports and events. With high video quality and a system that can be adapted to various situations, this camera provides the level of high-end production that is needed in the 4K age.

\*1: When in HD Hi-Speed mode. \*2: A codec developed by intoPIX. Stands for "Tiny Codec". \*3: Supported via optional accessory (additional fee).

## High Resolution

This camera has a newly developed large 4.4K sensor. Beyond 4K sampling is used to achieve an ultra-high-definition resolution of 2000 TV lines.

## 12G-SDI / TICO

UHD 12G-SDI\* output (x2) and TICO over SDI output (x1) included as a standard feature.

\* Quad-Link 3G-SDI output is also available.

## High Speed

Supports high-speed\* 2x, 3x or 4x output in HD mode at 1080p, 1080i and 720p simultaneously with standard (1x) output.

\* When in HD Hi-Speed mode.



AK-UC4000



AK-UCU600



AK-HRP1005 AK-HRP1000



### 4K Studio Camera

**AK-UC4000GJ**  
(Tajimi connector model)

**AK-UC4000GSJ**  
(LEMO connector model)

\* Lens and viewfinder are optional.

#### Large 4.4K sensor

With a newly developed 4.4K sensor, it realizes ultra-high-definition resolution, high sensitivity, low noise and a wide dynamic range.



#### B4 mount

The 2/3 lens can be used without an external adapter, and the internal lens is specially designed for large sensors, ensuring high video quality. This new acquisition method maximizes the effectiveness of incident light.

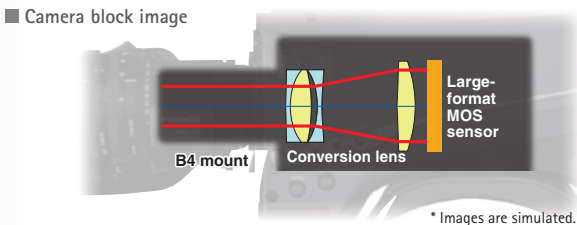

#### 2000-TV line resolution

Beyond 4K sampling achieves a resolution of 2000 TV lines in the horizontal and vertical directions for a richly detailed picture of a wide range of subjects in a variety of settings.

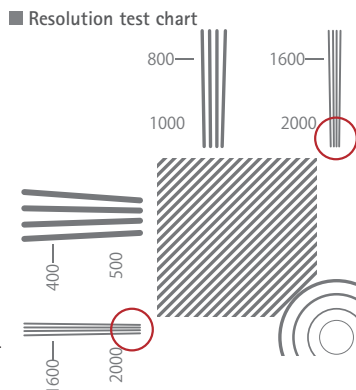

\* Images are simulated.

#### Supports 3 levels of high-speed output\* in HD mode

High-speed capture at 1080p, 1080i and 720p is available for sports and other active settings. This feature achieves a richly detailed picture even for fast-moving subjects. 2x, 3x or 4x output can be selected for compatibility with various slow-motion servers.

\* When in HD Hi-Speed mode.



\* Images are simulated.

#### Future proof infrastructure in AK-UCU600 (CCU)

This camera supports the uncompressed 12G-SDI output that is needed in the 4K age and enables 4K video to be transferred with one cable. Light compression technology called TICO\*1 is also used, enabling 4K video to be sent by 3G-SDI without losing video quality, so that the current HD infrastructure can be used in 4K systems. Also compatible with V-Log Gamma output\*2. Furthermore, the IP/12G/3G Interface Kit AK-NP600G (optional accessory) can be equipped for SMPTE ST2110 support\*3.

\*1: A codec developed by intoPIX. Stands for "Tiny Codec".  
\*2: Use requires the latest software version update. For more details, please see "Service and Support/PASS" on the following website (<https://pro-av.panasonic.net/en/>).  
\*3: See page 5 for details.

#### Rear of AK-UCU600 camera control unit (CCU)

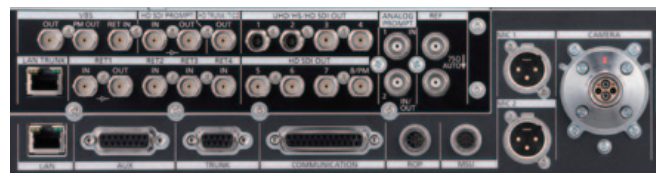

# AK-UC4000 Key Features

## High-quality video and excellent operability

With the AK-UCU600 Camera Control Unit (CCU), uncompressed long-distance transmission of 4K/HD video signals via optical fiber is supported. The AK-HRP1000GJ/1005GJ Remote Operation Panels (ROP) are equipped with a color LCD display that provides excellent visibility and functions for quick response. This system achieves high-quality video and excellent operability. In cases where power is supplied by the CCU, it is possible to transmit at a long distance of up to approx. 2,000 m between the camera and the CCU. The distance can be extended up to 10,000 m\*1 by providing a local power supply at the camera head and using general-purpose single mode optical fiber. Between the CCU and the ROP, in addition to a dedicated serial line, IP connection via LAN cable is also supported.

## High sensitivity and low noise

The AK-UC4000 is equipped with a newly developed large-format 4.4K MOS sensor. Two shooting modes can be selected. In High Sense Mode, it is possible to obtain an S/N ratio of 62 dB\*2 or higher while also achieving F10 high sensitivity. The result is low-noise and high-image-quality video.

## Skew reduction realized through high-speed scans

This camera's normal and low skew reading speeds are around 1/2 and 1/3 of those on a standard camera (1/60 of a second) respectively. The skewing characteristic of MOS sensors has been reduced by reading out the MOS sensor signal at high speed.

■ Skew reduction images



\* Images are simulated.

## Chromatic Aberration Compensation (CAC)

This exclusive technology utilizes communication between the lens and camera to deploy for a sophisticated algorithm that will automatically compensate for the registration error caused by lens chromatic aberration, and minimize the circumjacent blur.\*3

■ Images showing CAC (Chromatic Aberration Compensation) function effect



\* Images are simulated.

## HDR (High Dynamic Range) support



This mode provides rich gradation to render contrast, color and shadow in dark image areas that could not previously be reproduced due to blackout, thus resulting in more realistic image quality. It supports a variable HDR by adjusting the high dynamic range. In addition, it is possible to configure a system supporting simultaneous HDR/SDR in order to handle production environments with both. SDR image can be adjusted over exposed by offset gain and knee function adjusts bright image as well as HDR.

■ HDR adjustment function

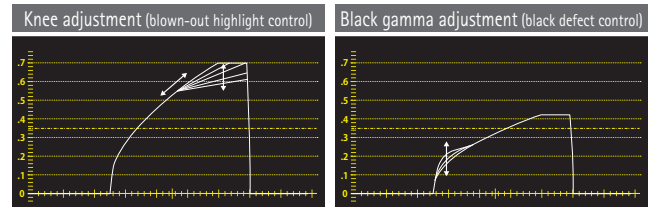

## ITU-R BT.2020

This camera is compatible with BT.2020, a color space that can recreate almost every color in the natural world, enabling a wider range of color expression.

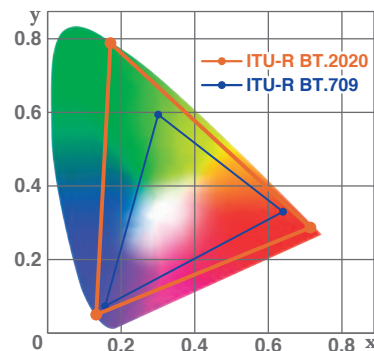

## Shockless gain

It is possible to smoothly transition the image changes that occur when gain is changed. In addition, with the 0.1 dB step master gain adjustment function, you can fine tune the adjustments to match the scene being shot.

\*1: Adverse conditions, additional patching and longer runs will require repeater devices.

\*2: During HD output

\*3: For software supporting Chromatic Aberration Compensation (CAC) file, please download from "Download/Software Download" on Panasonic website (<https://pro-av.panasonic.net/en/>)

## Diverse color correction functions

In addition to EBU and NTSC preset color matrix, camera users can save two custom specified linear matrix tables, and additionally tune the saturation and hue individual colors with 12-pole color correction system. Specific skin tones can also be adjusted in addition to the primary secondary and tertiary colors in the 12-pole system.

## Skin Tone Detail Correction

Tone down wrinkles and blemishes in on air personalities to beautifully shoot natural skin tones. While designed to soften skin tones the skin tone detail feature can be applied to any hue phase so it could likewise be used to soften areas of other colors (such as green grass). The skin tone detail feature can define three independent skin tone ranges to manage different light levels or different people on camera. Skin-tone-get feature finds a specific color in frame to simplify the set up process.

### Images showing Skin Tone Detail Correction effect

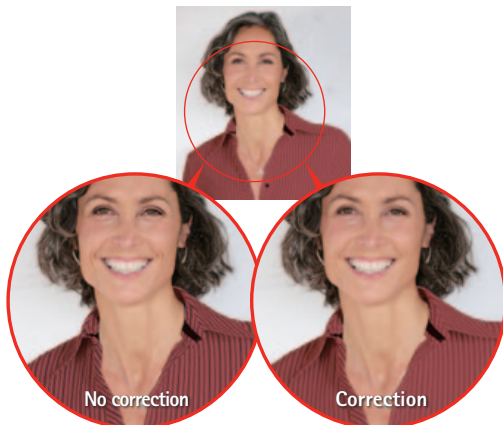

\* Images are simulated.

## Servo control ND / CC filters

The cameras are equipped with filters for a variety of shooting environments. [ND filters] CAP, Through, 1/4, 1/16, 1/64 [CC filters] Cross, 3200 K, 4300 K, 6300 K, Diffusion

## Focus assist functions

Quick and accurate focusing is supported with focus assist functions such as Focus Bar (indicates focus level), Focus-in-Red (uses color to indicate areas in focus), MAG (magnifies central portion), and Square (shows focus status of screen as a whole). Lenses with auto focus and focus assist capabilities are also supported\*1. The Remote Operation Panel (ROP) can also be used to focus and zoom while using the digital lens.

### Focus assist function examples

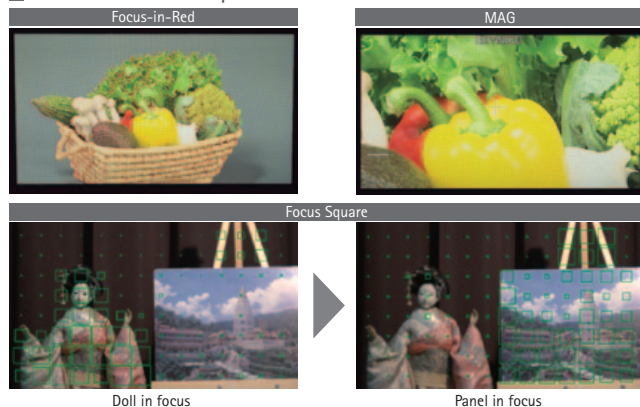

## Camera standalone output formats

For camera head output (HD-SDI 1/HD-SDI 2), it is possible to select 1080p, 1080i, and 720p.

## Extensive video and data transmission (TRUNK) functions

Since video and data can be transmitted between the camera and a Camera Control Unit (CCU) using optical fiber cable alone, system expansion to match operation conditions is possible.

- HD-SDI (CCU→camera) two lines, VBS (CCU→camera) two lines: Can be used for monitoring with prompter, fixed return or camera (studio floor monitor), etc.
- HD-SDI (camera→CCU) one line: This line can be used to transmit an additional video signal of a handheld or remote camera to the studio. Since the camera video input is equipped with a frame synchronizer, asynchronous video signals can also be used.
- LAN (1000BaseT) one line: To be used to control external devices and remote cameras by IP protocol. Transmission of streaming video is also supported.
- DATA (RS422A or RS232C) two lines: Can be used to transfer lens and pedestal position data in a virtual system.

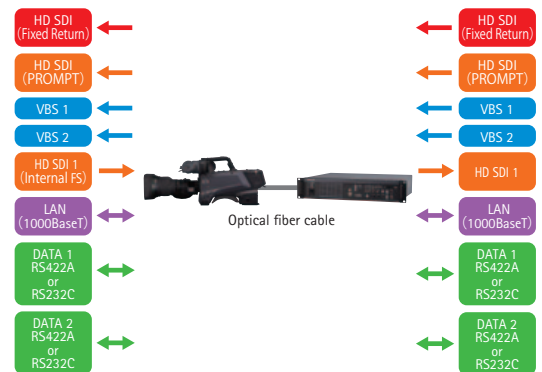

## Detailed settings and functions optimized for operability

- Color temperature display and adjustment function (2000 K to 15000 K variable).
- Transmission of up to 10,000 m possible using single fiber.\*2
- It is possible to save camera settings, such as video adjustments, on an SD memory card. Firmware version upgrades are also supported.
- A lens file function to save flare and shading values.
- Support for IP streaming and IP control.
- The NewTek Software "NewTek AutoLink for Panasonic PTZ"\*3, which is available on the Internet, allows Panasonic professional cameras equipped with IP streaming to be automatically detected from NewTek TriCaster® and IP series Video Mix Engine on the network, enabling direct use of IP streaming from the cameras with these NewTek products.
- DC12 V 2.5 A and 1.0 A output as a standard feature. This can be used as a power source for large lenses, prompters, and sub-monitors.
- There are four user buttons (enabling function selection) on the camera head and four on the viewfinder. They support rapid shooting by the camera operator.

## Intercom connection

With two independent intercom lines, in addition to Intercom 1 and Intercom 2 switching, an Intercom 1 and 2 mix mode has been added and can be selected to observe the situation. With the Intercom front/rear switch and front volume, it is possible to adjust the intercom audio level even when the camera is being used from the shoulder.

### Intercom Operation Panel



\*1: For the compatible lenses, please contact the manufacturer.

\*2: Adverse conditions, additional patching and longer runs will require repeater devices.

\*3: For more details, please visit the following website([https://pro-av.panasonic.net/en/products/newtek\\_autolink/](https://pro-av.panasonic.net/en/products/newtek_autolink/)).

## AK-UCU600PJ/UCU600EJ AK-UCU600PSJ/UCU600ESJ Camera Control Unit (CCU)

AK-UCU600PJ/AK-UCU600EJ (Tajimi connector model)  
AK-UCU600PSJ/AK-UCU600ESJ (LEMO connector model)

The CCU supports not only UHD and HD simultaneous output, but also enables high-speed output\*1 up to 240p in HD mode to be performed simultaneously with standard (1x) output, while still having a compact size.



### Rear View

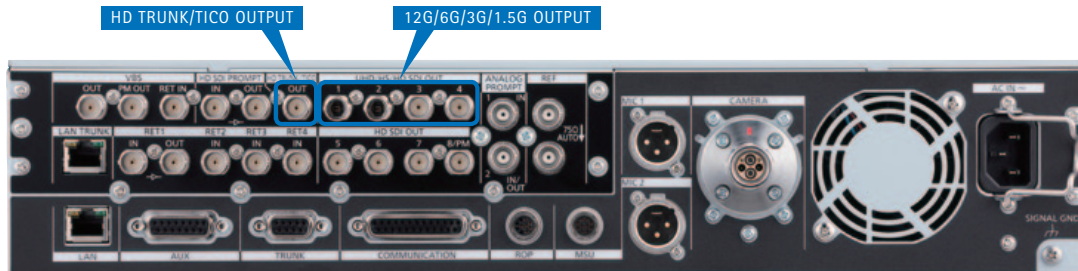

- Contains a dual UHD 12G-SDI system, and supports 3G-SDI Quad Link with quadrant or two-sample interleave.
- Optical fiber transmission of uncompressed video signals over a distance of approx. 2,000 m between camera and CCU\*2.
- The compact, lightweight unit measures 2U in height and is rack-mountable.

#### Supported formats

UHD	3840x2160/59.94p, 50p, 29.97p, 25p, 23.98p, 29.97PsF, 25PsF, 23.98PsF, 23.98PsF & over59.94i
HD	1080/59.94p, 50p, 59.94i, 50i, 23.98p over 59.94i, 29.97PsF, 25PsF, 23.98PsF, 23.98PsF & over59.94i, 720/59.94p, 50p
HD High Speed*1	1080/59.94p-240fps, 180fps, 120fps, 1080/50p-200fps, 150fps, 100fps, 1080/59.94i-240fps, 180fps, 120fps, 1080/50i-200fps, 150fps, 100fps, 720/59.94p-240fps, 180fps, 120fps, 720/50p-200fps, 150fps, 100fps

- Supports IP streaming (100 Base-T).
- SD memory card can be used for saving user files and updating firmware versions.
- Dual uncompressed 12G-SDI output.
- Supports TICO\*3 over SDI (4K over 3G-SDI) output (4K signal can be transferred by a conventional 3G-SDI cable).
- Supports 1080p/i and 720p. In addition to standard output, high-speed output\*1 at 2x, 3x or 4x can be selected according to the specifications of the server.
- Supports HDR/SDR simultaneous output and HDR BT.2020/BT.709 simultaneous output.
- 12G-SDI output and TICO\*3 over SDI (4K over 3G-SDI) output are compatible with the AK-UC3000.

\*1: When in HD Hi-Speed mode.

\*2: When power is supplied from CCU.

\*3: A codec developed by intoPIX. Stands for "Tiny Codec".

### AK-UCU600 optional accessory

## AK-NP600G IP/12G/3G Interface Kit

Optional IP kit for installation on the rear terminal of the AK-UCU600

- SMPTE ST2110 standard compliant
- Supported formats: 1080/59.94p, 50p, 59.94i, 50i, 720/59.94p, 50p
- The following input/output is supported:  
CAMERA Output, RET Input, HD TRUNK Output, HD PROMPTER IN, AUDIO Output, INTERCOM, PGM Input, ST2059 (PTP), TALLY

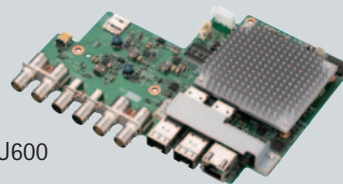

\*SFP+ Transceiver needs to be purchased separately.  
operation-verified SFP Module  
Finisar Corporation  
SFP+ Transceiver/FTLX1475D3BTL

### The AK-NP600G installed on the rear terminal of the AK-UCU600

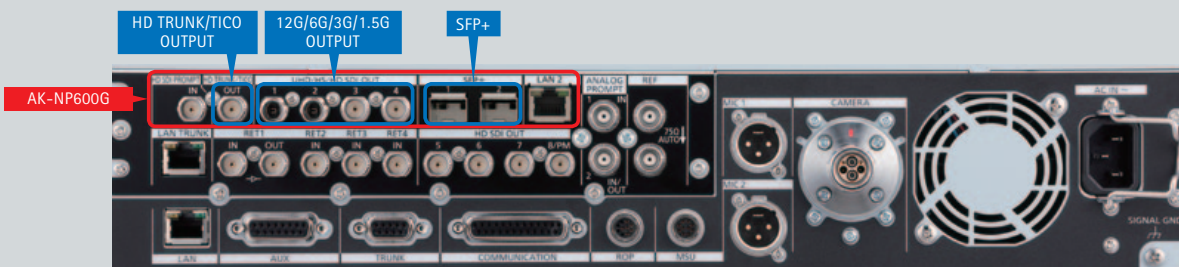

- \* 12G two outputs, 3Gx4 one output or TICO one output in UHD mode. HD (3G/1.5G) four outputs and SFP+ (ST2110) two outputs are supported in HD mode.
- \* AK-NP600G (IP/12G/3G Interface Kit) does not support analog VBS input/output signals (OUT/PM OUT/RET IN).
- \* AK-UC4000 (4K Studio Camera) and AK-UCU600 (Camera Control Unit) firmware upgrades are required to install AK-NP600G (IP/12G/3G Interface Kit).  
See Service and Support/PASS on the Panasonic website for details (<https://pro-av.panasonic.net/en/>).
- \* Consult with your Panasonic dealer about AK-NP600G (IP/12G/3G Interface Kit) installation.

# AK-HRP1000GJ\*<sup>1</sup> AK-HRP1005GJ\*<sup>1</sup>

## Remote Operation Panel (ROP)

- Two models: 1/4 rack size (AK-HRP1000GJ) and 1/5 rack size (AK-HRP1005GJ).
- LCD panels with enhanced visibility.  
AK-HRP1000GJ: 8.9 cm (3.5 inches) (VGA)  
AK-HRP1005GJ: 8.1 cm (3.2 inches) (VGA)
- Camera serial control and IP control (RJ45 LAN cable) are possible.
- Supports PoE\*<sup>2</sup>, which can supply power via LAN cable (CAT5e or faster).
- Functions for studio camera scene file registration and retrieval.
- Equipped with SD memory card slot for saving user files, scene file and updating firmware versions.
- Camera control is enabled via direct connection to the 4K Studio Camera.

\*1: Use requires the latest software version update. For more details, please see "Service and Support/PASS" on the following website(<https://pro-av.panasonic.net/en/>).

\*2: Abbreviation of Power over Ethernet.

Expand operation scope with two size options: a full operation panel and a simplified panel. These compact operation panels also support PoE\*<sup>2</sup> and IP control.



AK-HRP1000GJ



AK-HRP1005GJ

### Rear View

AK-HRP1000GJ



AK-HRP1005GJ



# AK-HVF100GJ

## 22.9 cm (9 inches) LCD Color Viewfinder

Equipped with newly designed tilt mechanism and extensive functions such as focus assist and external video input.

- High-resolution 22.9 cm (9 inches) color LCD panel displays full HD 1920 x 1080 pixel
- Focus assist functions (Focus-in-Red, Focus Bar\*<sup>1</sup>)
- Detail depends on zoom ratio\*<sup>1</sup>
- External HD-SDI (3G-SDI) input
- External DC input (+12 V DC)
- Four assignable function buttons
- Contrast, brightness, and peaking are adjustable
- Pan, tilt, and lift structure used

\*1: When connected to AK-UC4000.



### Rear View

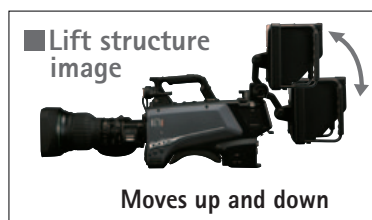

# AK-MSU1000GJ\*<sup>1</sup>

## Master Setup Unit (MSU)

Controls up to 99 CCU units via IP

- IP and serial connections supported.  
IP connection: Up to 99 units  
Serial connection: Up to six units
- 17.8 cm (7 inches) Touch Panel LCD
- Video monitoring function
- HD-SDI Input (Monitoring) (1080i)
- Power:DC12 V(DC10 V - DC16 V) or PoE+\*<sup>2</sup> (via PoE+ Hub)

\*1: Use requires the latest software version update. For more details, please see "Service and Support/PASS" on the following website(<https://pro-av.panasonic.net/en/>).

\*2: Abbreviation of Power over Ethernet.



### Rear View



# AK-HBU500GJ

## Build-up Unit

Enables use of large studio-use lens.

- Smooth camera mounting/removal possible
- Precise optical axis (horizontal/vertical) adjustment structure
- Rear control panel equivalent to that of a large camera
- DC OUT 12V 7.5 A (XLR4-pin)/DC OUT 1.5 A (4-pin)



### Side View

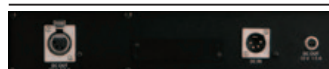

### Rear control panel



\* It may require to replace lens mount parts at using a specific 4K lens. Please contact your dealer for more details.

## Other accessories



**AJ-CVF50G**  
38.1 mm (1.5 inches) HD EVF



**AJ-HVF21KG**  
50.8 mm (2 inches) HD EVF  
59.94 Hz/50 Hz Switchable  
Not available in some areas.



**AG-CVF15G**  
87.6 mm (3.45 inches) Color HD EVF  
Open two ways for LCD monitor viewing



**AK-HVF75G** NEW  
17.8 cm (7 inches) LCD Color  
Viewfinder



**AK-HVF70G**  
17.8 cm (7 inches) LCD Color  
Viewfinder

\*Limited Stock



**AJ-MC700P**  
Microphone Kit (monaural)



**AW-PS551**  
AC Adaptor

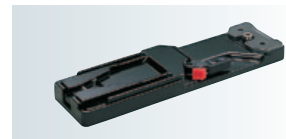

**SHAN-TM700**  
Tripod Adaptor

**AJ-C10050G**  
Remote Control Cable  
(50 m / 164 feet)

## System Configuration

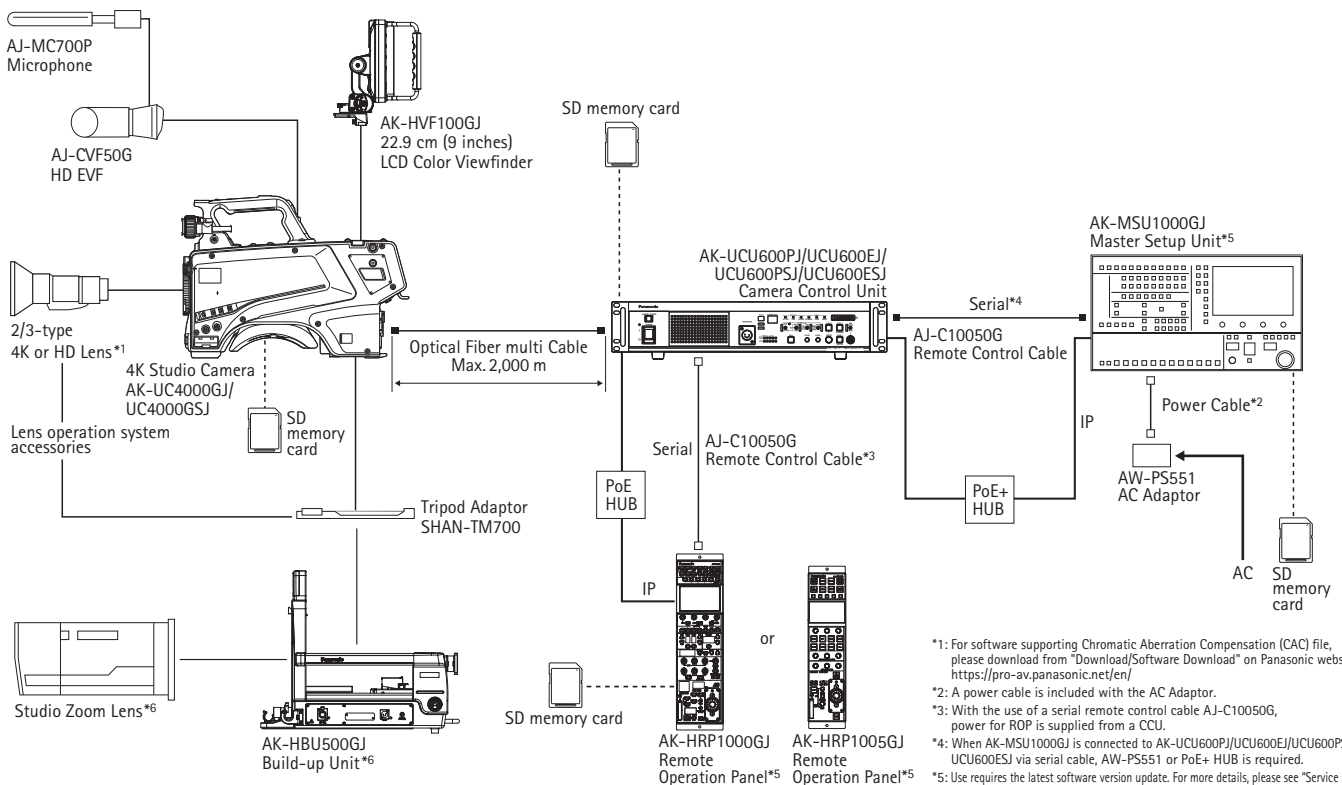

\*1: For software supporting Chromatic Aberration Compensation (CAC) file, please download from "Download/Software Download" on Panasonic website: <https://pro-av.panasonic.net/en/>

\*2: A power cable is included with the AC Adaptor.

\*3: With the use of a serial remote control cable AJ-C10050G, power for ROP is supplied from a CCU.

\*4: When AK-MSU1000GJ is connected to AK-UCU600PJ/UCU600EJ/UCU600PSJ/UCU600ESJ via serial cable, AW-PS551 or PoE+ HUB is required.

\*5: Use requires the latest software version update. For more details, please see "Service and Support/PASS" on the following website (<https://pro-av.panasonic.net/en/>).

\*6: It may require to replace lens mount parts at using a specific 4K lens. Please contact your dealer for more details.



## AK-UC4000GJ/UC4000GSJ

Power Supply	DC 12 V (when using an external power supply) AC 240 V, 50 Hz/60 Hz (when connecting to an AK-UCU600PJ/ AK-UCU600EJ/AK-UCU600PSJ/AK-UCU600ESJ)
Power Consumption	119 W (maximum for the camera only, when connecting to an external 12 V) 360 W (when connecting to an AK- UCU600PJ/AK-UCU600EJ/AK-UCU600PSJ/AK-UCU600ESJ)
Operating Temperature	-10 °C to 45 °C (14 °F to 113 °F) (Preheating required under a temperature 0 °C (32 °F) or below)
Storage Temperature	-20 °C to 60 °C (-4 °F to 140 °F)
Operating Humidity	85% or less (relative humidity)
Weight	Approx. 4.5 kg (9.90 lb) (body only)
Dimensions (W x H x D)	Body only 151 mm x 267 mm x 371.5 mm (5-31/32 inches x 10-17/32 inches x 14-21/32 inches) (excluding protrusions)
Pickup Device	11.14 million pixels, MOS x 1
Optical Filter	CC: 3200 K, 4300 K, 6300 K, Cross, Diffusion ND: CAP, Clear, 1/4, 1/16, 1/64
Lens mount	2/3-type bayonet
Sensitivity	Two shooting modes [HIGH SENS]: F10 (59.94 Hz)/F11 (50 Hz) [NORMAL]: F6 (59.94 Hz)/F7 (50 Hz) 2000 lx, 3200 K, when white reflectivity is 89.9%
Horizontal Resolution	4K: 2000 TV lines or above (center) AK-UCU600PJ/AK-UCU600EJ/AK-UCU600PSJ/ AK-UCU600ESJ output HD: 1000 TV lines or above (center)
S/N	62 dB or above
Horizontal Modulation	50% or above (27.5 MHz)
Gain switching	[NORMAL]: -6, -3, 0, 3, 6, 9, 12, 15, 18, 21, 24, 27, 30, 33, 36 [HIGH SENS]: -6, -3, 0, 3, 6, 9, 12, 15, 18, 21, 24, 27, 30, 33, 36
Shutter speed	<ul style="list-style-type: none"> <li>•[59.94i]/[59.94p] mode: 1/100, 1/120, 1/125, 1/250, 1/500, 1/1000, 1/1500, 1/2000</li> <li>•[29.97p] mode: 1/48, 1/50, 1/60, 1/96, 1/100, 1/120, 1/125, 1/250, 1/500, 1/1000, 1/1500, 1/2000</li> <li>•[23.98p] mode: 1/48, 1/50, 1/60, 1/96, 1/100, 1/120, 1/125, 1/250, 1/500, 1/1000, 1/1500, 1/2000</li> <li>•[50i]/[50p] mode: 1/60, 1/100, 1/125, 1/250, 1/500, 1/1000, 1/1500, 1/2000</li> <li>•[25p] mode: 1/48, 1/50, 1/60, 1/96, 1/100, 1/125, 1/250, 1/500, 1/1000, 1/1500, 1/2000</li> </ul>
<HD-SDI1> terminal	BNC x 1 3G/1.5G-SDI: 0.8 V [p-p], 75 Ω
<HD-SDI2> terminal	BNC x 1 3G/1.5G-SDI: 0.8 V [p-p], 75 Ω
<AUX> terminal	BNC x 1 Functions as <HD TRUNK> terminal/<PROMPTER2> terminal by switching the setting in the menu <HD TRUNK>: 1.5G-SDI: 0.8 V [p-p], 75 Ω <PROMPTER2>: VBS signal 1 V [p-p], 75 Ω
<G/L IN/PROMPTER OUT> terminal	BNC x 1 <G/L IN>: Tri-level SYNC or BB (black burst) <PROMPTER OUT>: VBS signal 1 V [p-p], 75 Ω Functions as <G/L IN> when standalone, and as <PROMPTER OUT> when connecting to an AK-UCU600PJ/AK-UCU600EJ/AK-UCU600PSJ/ AK-UCU600ESJ
<MIC 1> terminal	XLR x 1, 3-pin (female) <LINE>/<MIC>/<+48 V> switchable For <MIC>, <FRONT>/<REAR> switchable <LINE>: 0 dBu, +4 dBu menu selection available <MIC>: -60 dBu, -40 dBu, or -20 dBu menu can be selected
<MIC 2> terminal	XLR x 1, 3-pin (female) <LINE>/<MIC>/<-48V> switchable <LINE>: 0 dBu, +4 dBu menu selection available <MIC>: -60 dBu, -40 dBu, or -20 dBu menu can be selected
<MIC> terminal (front)	XLR x 1, 3-pin (female) Switchable with <MIC 1> terminal
<INTERCOM1> terminal	XLR x 1, 5-pin (female)
<INTERCOM2> terminal	XLR x 1, 5-pin (female)
<EARPHONE> terminal	Stereo mini jack x 1
<OPT FIBER> terminal	Optical composite connector x 1, Tajimi/LEMO
<LENS> terminal	12-pin x 1
<VF> terminal	20-pin x 1

<VF> terminal (rear)	29-pin x 1
<DC IN> terminal	XLR x 1, 4-pin, DC 12 V
<DC OUT 12 V 1 A> terminal	4-pin x 1
<RET CTRL> terminal	6-pin x 1
<EXT I/O> terminal	20-pin x 1, DC 12 V 0.5 A
<REMOTE> terminal	10-pin x 1
<TRUNK> terminal	12-pin x 1
<DC OUT> terminal	2-pin x 1, DC 12 V 2.5 A
<LAN> terminal	RJ-45 x 1
<USB2.0> terminal (host)	Type A connector, DC 5 V 0.5 A
Build-up terminal	20-pin x 1

## AK-UCU600PJ/UCU600EJ/UCU600PSJ/UCU600ESJ

Power Supply	AK-UCU600PJ/AK-UCU600PSJ: 100 V - 120 V AC, 50 Hz/60 Hz AK-UCU600EJ/AK-UCU600ESJ: 100 V - 240 V AC, 50 Hz/60 Hz
Power Consumption	500 W (Without camera connected: 90 W)
Capacity for Supplying Power to a Camera	240 V AC (tolerance: 5%), 1.46 A, 50 Hz/60 Hz
Operating Temperature	0 °C to 40 °C (32 °F to 104 °F)
Humidity	10% to 90% (no condensation)
Weight	Approx. 8.9 kg (19.6 lb)
Dimensions (W x H x D)	424 mm x 88 mm x 401 mm (16-5/8 inches x 3-7/16 inches x 15-13/16 inches) (excluding protrusions)
Video Output	3G/HD-SDI: 5 lines (embedded audio is supported only for HD signals) 12G/6G/3G/HD-SDI: 2 lines HD-SDI: 1 line (shared with picture monitor output*) Analog composite: 2 lines (1 line shared with picture monitor output*)
* For details on output formats, see "Supported formats" on page 5.	
HD TRUNK/TICO Output	HD-SDI: 1 line (HD TRUNK output) 3G/HD-SDI: 1 line (TICO output)
Return Input	3G-HD/HD/SD-SDI: 4 lines (RET1 input has active-through output) Analog composite: 1 line
Prompter Input	HD-SDI: 1 line (with active-through output) Analog composite: 2 lines (through output of 1 and input of 2 share the connector*) It is not terminated when the unit is turned OFF. No through output.
Reference Input	BB (black burst) / tri-level*: 1 line (automatic termination, connect to upper connector; BB signal and tri-level signal automatically recognized, with loop-through output)
Microphone Output	0 dBm/600 Ω, 2 lines (XLR, 3-pin, male)
Communication	Intercom input/output (ENG / PROD, 0 dBm, 600 Ω (4 W) / 1 V [p-p], 200 Ω (RTS), 4 W / RTS / CLRCOM) : 2 lines*1 PGM input (0 dBm/600 Ω) : 2 lines Tally input (red, green, yellow) : 1 input each
AUX	WFM control 6-bit (open collector output, terminal shared with camera microphone gain setting*) Camera microphone gain setting input 5-bit (photo-coupler input, terminal shared with WFM control*) Down-conversion system setting input 2-bit (photo-coupler input)
TRUNK	RS-422 / RS-232C 2 lines*1
FRONT ROP	RS-422 1 line, 16 V DC output (only one of this and REAR ROP can be selected at one time via the menu or the [ROP FRONT/ REAR] selection switch on the front panel)
REAR ROP	RS-422 1 line, 16 V DC output (only one of this and FRONT ROP can be selected at one time via the menu or the [ROP FRONT/REAR] selection switch on the front panel)
MSU	RS-422 1 line, GPI for control
LAN TRUNK	LAN connection with camera side via an optical cable*3 1 line, 100BASE-TX, 100BASE-T
LAN	Personal computer connection for distribution via the Web*3 1 line, 10BASE-T, 100BASE-TX (use a crossover cable when connecting directly with a personal computer)

\*1: Depending on the setting, only one of them can be selected at one time.

\*2: The BB (black burst) signal and tri-level sync signal of the reference input are recognized automatically.

\*3: IP video cannot be transmitted when [CCU MODE] is set to [2160/23.98p], [2160/23.98PsF], [1080/23.98p], or [1080/23.98PsF].

# Specifications

As of August, 2019

## AK-NP600G

Dimensions (W x H x D)	Approx. 175.5 mm x 28.8 mm x 138.5 mm (6-29/32 inches x 1-1/8 inches x 5-7/16 inches)	
Weight	Approx. 284 g (0.63 lbs) (including radiator fins)	
Operating Temperature	0 °C to 40 °C (32 °F to 104 °F)	
Humidity	10% to 90% (no condensation)	
Input/Output Section	<UHD/HS/HD SDI OUT1> terminal	BNC x 1, 12G/6G/3G/1.5G HD SDI: 0.8 V [p-p], 75 Ω
	<UHD/HS/HD SDI OUT2> terminal	BNC x 1, 12G/6G/3G/1.5G HD SDI: 0.8 V [p-p], 75 Ω
	<UHD/HS/HD SDI OUT3> terminal	BNC x 1, 3G/1.5G HD SDI: 0.8 V [p-p], 75 Ω
	<UHD/HS/HD SDI OUT4> terminal	BNC x 1, 3G/1.5G HD SDI: 0.8 V [p-p], 75 Ω
	<HD TRUNK/TICO OUT> terminal	BNC x 1, 1.5G HD SDI when HD TRUNK, 3G/1.5G HD SDI when TICO: 0.8 V [p-p], 75 Ω
	<HD SDI PROMPT IN> terminal	BNC x 1, 1.5G HD SDI: 0.8 V [p-p], 75 Ω
	<SFP+ 1> slot	SFP+ x 1, 10GBASE-LR
<SFP+ 2> slot	SFP+ x 1, 10GBASE-LR	
<LAN2> terminal	RJ-45 x 1	
Bundled Items	Pillar (M3 x H20) x 1, Options rear panel x 1, Power cable x 1, Heat-transfer sheet x 1, Gaskets x 2	

## AK-HRP1000GJ/HRP1005GJ

	AK-HRP1000GJ	AK-HRP1005GJ
Power Supply	12 V DC (Power supply from camera: 10 V - 16 V DC) 42 V - 57 V DC (PoE power supply)	
Power Consumption	0.51 A (Power supply from camera: 10 V - 16 V DC) 0.15 A (PoE power supply)	0.44 A (Power supply from camera: 10 V - 16 V DC) 0.11 A (PoE power supply)
Operating Temperature	0 °C to 40 °C (32 °F to 104 °F)	
Humidity	90% or less	
Storage Temperature	-20 °C to 60 °C (-4 °F to 140 °F)	
Weight	Approx. 1.7 kg (3.75 lb)	Approx. 1.5 kg (3.31 lb)
Dimensions (W x H x D)	102 mm x 385 mm x 113 mm (4 inches x 15-3/16 inches x 4-7/16 inches)	82 mm x 355 mm x 124.4 mm (3-1/4 inches x 14 inches x 4-7/8 inches)
Camera/CCU Control	Control signals (camera, CCU control) Power supply 16 V DC (when CCU is connected)*1, 12 V DC (when camera is connected)*	
Maximum Cable Length	When camera connected: 20 m (65.7 ft) When CCU is connected: 50 m (164 ft)	

## AK-MSU1000GJ

Power Supply	12 V DC (DC input range: 10 V - 16 V DC) 42 V - 57 V DC (PoE+ power supply)
Power Consumption	1.6 A (Power supply: 12 V DC) 0.6 A (PoE+ power supply)
Operating Temperature	0 °C to 40 °C (32 °F to 104 °F)
Humidity	90% or less
Storage Temperature	-20 °C to 60 °C (-4 °F to 140 °F)
Weight	Approx. 4.0 kg (8.82 lb)
Dimensions (W x H x D)	482 mm x 222 mm x 81.5 mm (18-31/32 inches x 8-3/4 inches x 3-7/32 inches) (including mounting brackets and dial heights)
Adjustment Functions	Scene file, ND filter, CC filter, Color temperature (COLOR TEMP), Master gain (MASTER GAIN), Shutter (SHUTTER), Master pedestal (MPED), Iris (IRIS), Camera selection
CCU Control	RS422 or IP
Maximum Cable Length	When CCU is connected: 50 m (164 ft)

## AK-HVF100GJ

Power Supply	DC 12 V (supplied from camera or XLR)
Power Consumption	18 W
Operating Temperature	0 °C to 45 °C (32 °F to 113 °F)
Operating Humidity	10% - 85% (no condensation)
Storage Temperature	-20 °C to 60 °C (-4 °F to 140 °F)
Weight	Approx. 2.6 kg (5.73 lbs.) (not including hood) / Approx. 3.0 kg (6.61 lbs.) (including hood)

Dimensions (W x H x D)	340 mm x 234 mm x 193 mm (13-13/32 inches x 9-7/32 inches x 7-5/8 inches) (not including hood) 340 mm x 234 mm x 231 mm (13-13/32 inches x 9-7/32 inches x 9-1/8 inches) (including hood)
Display Panel	22.9 cm (9.0 inches)
Number of Pixels	1920 x 1080 (FHD)
Display Color	Approx. 16.77 million colors
Operation	<POWER> switch, <MENU> button, <SELECT> dial button, <F1>/<F2>/<F3>/<F4> buttons, <BRIGHT> knob, <CONTRAST> knob, <PEAKING> knob, <INPUT> switch
Connector	Camera I/F connector (D-sub 29 pins x 1) SDI IN connector (BNC x 1) DC IN connector (XLR 4 pins x 1)
Supported Signal Format	CAM: 1080/59.94i, 1080/50i SDI: 1080/59.94p, 1080/50p, 1080/59.94i, 1080/50i, 720/59.94p, 720/50p

## AK-HBU500GJ

Power Supply	12 V DC (when external power is supplied) 240 V AC 50 Hz/60 Hz (when CCU is connected)
Power Consumption	70 W (when external power is supplied) 165 W (when CCU is connected)
Operating Temperature	-10 °C to 45 °C (14 °F to 113 °F)
Operating Humidity Range	85% or less (relative humidity)
Storage Temperature	-20 °C to 60 °C (-4 °F to 140 °F)
Weight	Approx. 12.8 kg (28.22 lb) (unit only)
Dimensions (W x H x D)	300 mm x 417 mm x 510 mm (16-7/16 inches x 20-1/16 inches x 11-13/16 inches)
Camera Number Display	1 to 15 (depending on system settings)
LENS I/F Connector	36-pin x 1
CAMERA I/F Connector	20-pin x 1
[DC IN] Connector	XLR x 1, 4-pin, 12 V DC
[DC OUT 12 V 1.5 A] Connector	4-pin x 1
[DC OUT 12 V 7.5 A] Connector	XLR x 1, 4-pin

\*1: Can be provided from CCU

## AK-UC4000GJ/UC4000GSJ Rear View



# Dimensions

As of August, 2019

Unit: mm(inches)

## AK-UC4000GJ/UC4000GSJ

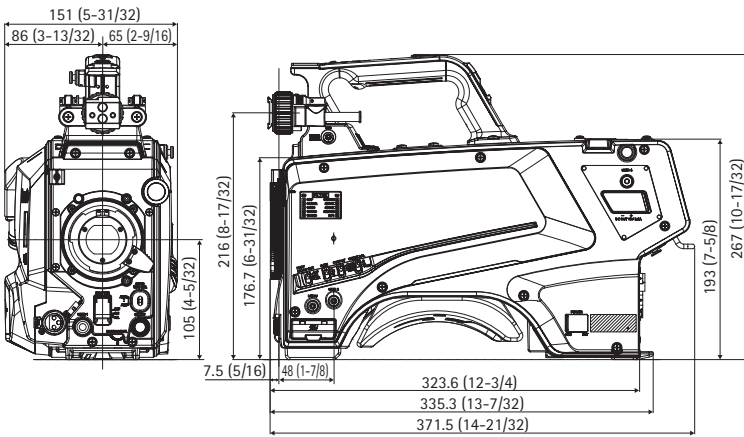

## AK-UCU600PJ/UCU600EJ/UCU600PSJ/UCU600ESJ

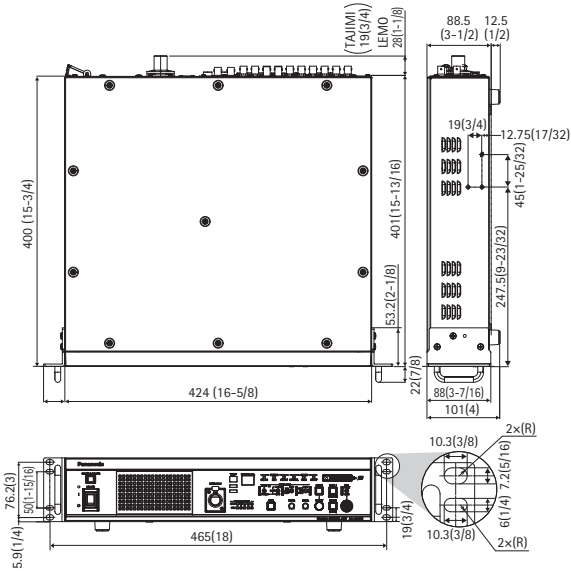

\* Dimensions are for LEMO connector model.

## AK-HRP1000GJ

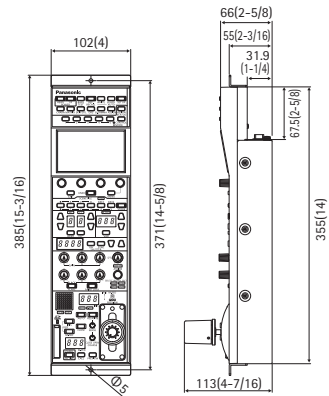

## AK-HRP1005GJ

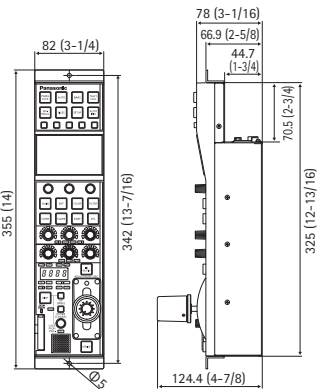

## AK-MSU1000GJ

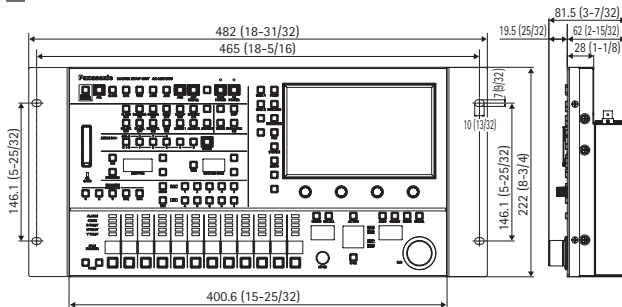

## AK-HBU500GJ

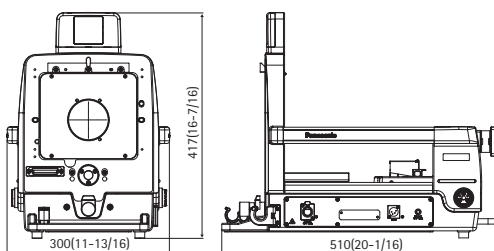

## AK-HVF100GJ

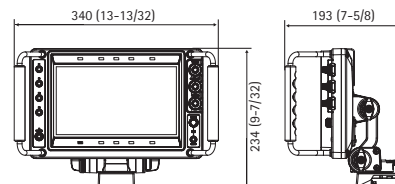

\* "Facebook" is a registered trademark of Facebook, Inc.  
\* Specifications are subject to change without notice.

# Panasonic®

Panasonic Corporation  
Connected Solutions Company

2-15 Matsuba-cho, Kadoma, Osaka 571-8503 Japan



Factories of AVC Networks Company have received ISO14001:2004-the Environmental Management System certification. (Except for 3rd party's peripherals.)



For more information, please visit Panasonic web site  
<https://pro-av.panasonic.net/en/qr/>



**Broadcast and Professional AV Website**



**Contact Information**



**Facebook**



**Mobile App**