



3 Door Sandwich/Salad Prep Table ♦ NP3R-SW



Standard Features

- ♦ Stainless steel series 430 exterior
- ♦ Stainless steel series 304 interior
- ♦ Stucco aluminum back panel
- ♦ Self closing hinged doors with 90 degree stay open feature
- ♦ Bottom mounted compressor
- ♦ Optional 3-inch legs
- ♦ LED digital temperature display
- ♦ PVC coated adjustable wire shelves
- ♦ Compartment barrier prevents food spillage down to storage area
- ♦ Lift off compartment door hinges for easy cleaning
- ♦ Pans and cutting boards are included
- ♦ 3/4" thick cutting board included
- ♦ Self contained system, simple installation
- ♦ Heavy-duty caster wheels

Technical Specifications

Product Classification	Refrigerator
Climate Class	N
Number of Doors / Lids	3 Doors / 1 Lid
External Cabinet Material	430 Stainless Steel
Internal Cabinet Material	304 Stainless Steel
Type of Refrigeration Agent	R-290
Type of Temperature Control	Digital
Temperature Range °C	0°C to 5°C
Temperature Range °F	32°F to 41°F
Voltage / Frequency	115V / 60Hz
Amp	8.9
Compressor HP	1/2+ HP
Type of Insulation	2.5-Inch Polyurethane Foam
Door Handle	Full Length

Certified Safety Standard

- ♦ ETL Listed
- ♦ ETL Sanitation Listed



Warranty Information

- ♦ 5 Years Compressor
- ♦ 3 Year Parts & Labor





3 Door Sandwich/Salad Prep Table ♦ NP3R-SW

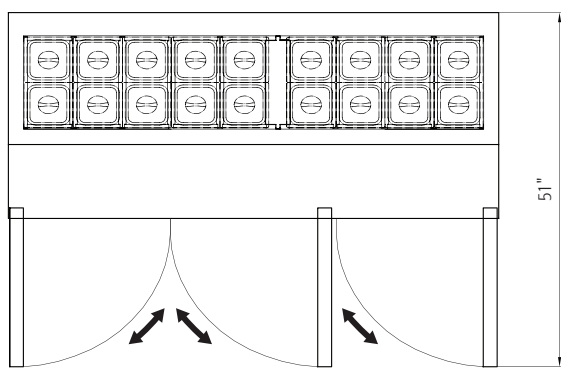

Top View

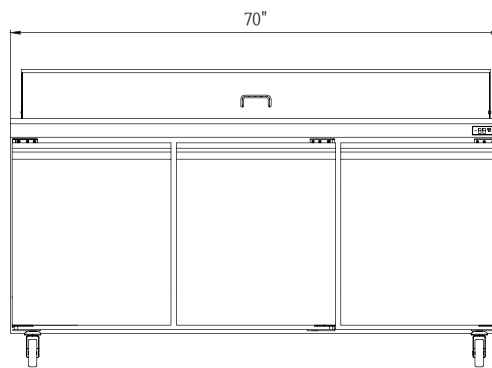

Front View

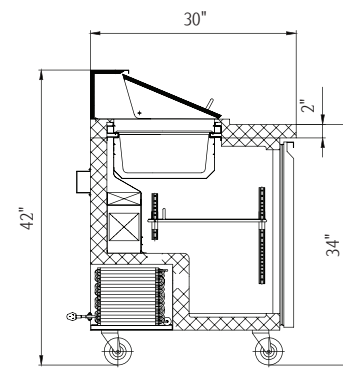

Side Section



Plug Type: (NEMA) 5-15P

Capacity

Gross Capacity 15.5 cu. ft.

Dimensions

Internal Cabinet Width	66 in
Internal Cabinet Depth	24 in
Internal Cabinet Height	24 in
External Width	70 in
External Depth	30 in
External Height	42 in
Shipping Dimensions (W x D x H)	75 x 35 x 46 in

Weight

Gross Weight 490 lbs.

Accessories

Frost Free	Yes
Adjustable Shelves	3
Fixed Shelves	No
Internal Light	No
Internal Light Switch	No
External Light Switch	No
Self Closing Door / Lid	Yes
Door Holder for Loading	Yes
Door / Lid Lock	No
Reversible (Left) Door	No
Adjustable Feet	Optional
Adjustable Thermostat	Yes
Pans	(18) 1/6"