

newline ***rs***⁺

User Manual

V2.0

Contents

- About This Document.....5**
- Safety Instruction.....6**
- 1 Overview.....9**
 - 1.1 Introduction9
 - 1.2 Parts9
 - 1.3 Ports12
 - 1.4 Remote Control.....16
- 2 Installation Guide18**
 - 2.1 Safety Precautions18
 - 2.2 Installation Precautions19
 - 2.3 Installation20
 - 2.4 Installing the Internal PC (Optional).....21
 - 2.5 Installing Newline Assistant23
- 3 Getting Started.....24**
 - 3.1 Power On24
 - 3.2 Power Off.....25
 - 3.3 Calibration25
- 4 Operating the Touch Screen28**
 - 4.1 Start Screen.....28
 - 4.2 Home29
 - 4.3 System Settings.....33
 - 4.3.1 Network Settings33
 - 4.3.2 Language and Input Settings.....34
 - 4.3.3 Storage.....36
 - 4.3.4 Applications37
 - 4.3.5 Whiteboard37
 - 4.3.6 Smart Eye Protection37
 - 4.3.7 Date and Time Settings38
 - 4.3.8 Power Settings40
 - 4.3.9 Tool Bar Settings41

4.3.10 Input/Output Settings.....	42
4.3.11 Display & Theme Settings.....	43
4.3.12 Security Settings.....	43
4.3.13 System.....	44
4.4 Windows.....	44
4.5 Screen Sharing.....	45
4.6 Whiteboard.....	45
4.6.1 Whiteboard Functions.....	48
4.6.2 Page Management.....	57
4.6.3 Object Detection.....	59
4.7 Browser.....	61
4.8 File Management.....	61
4.8.1 File Viewer Page.....	61
4.8.2 File Preview.....	62
4.8.3 File Search.....	62
4.8.4 File Filtering.....	63
4.8.5 New Folder.....	64
4.8.6 File Operation.....	64
4.8.7 File Name.....	64
4.9 Gadget.....	65
4.10 Add Shortcut.....	66
4.10.1 Add Shortcuts to Home Page.....	66
4.10.2 Add Quick Start Windows Programs in Smart System.....	68
4.11 Preview window.....	71
4.12 Automatically Power Off.....	71
5 Quick Setting Menu.....	72
6 Serial Port Control.....	74
7 FAQs & Troubleshooting.....	79
8 Specifications.....	82
9 More Information.....	85

Welcome to the world of Newline

Thank you for choosing the RS series Interactive Touch Screen. Please use this document to get the most out of your screen.

This device complies with part 15 of the FCC Rules. Operation is subject to the following two conditions: (1) This device may not cause harmful interference, and (2) this device must accept any interference received, including interference that may cause undesired operation.

NOTE 1: This equipment has been tested and found to comply with the limits for a Class B digital device, pursuant to part 15 of the FCC Rules. These limits are designed to provide reasonable protection against harmful interference in a residential installation. This equipment generates, uses, and can radiate radio frequency energy and, if not installed and used in accordance with the instructions, may cause harmful interference to radio communications. However, there is no guarantee that interference will not occur in a particular installation. If this equipment does cause harmful interference to radio or television reception, which can be determined by turning the equipment off and on, the user is encouraged to try to correct the interference by one or more of the following measures:

- Reorient or relocate the receiving antenna.
- Increase the separation between the equipment and receiver.
- Connect the equipment into an outlet on a circuit different from that to which the receiver is connected.
- Consult the dealer or an experienced radio/TV technician for help.

NOTE 2: Any changes or modifications to this unit not expressly approved by the party responsible for compliance could void the user's authority to operate the equipment.

The symbol of the crossed out wheeled bin indicates this product should not be placed in municipal waste. Instead, dispose of waste equipment by taking it to a designated collection point for electrical and electronic equipment recycling.



Energy Star Compliance.**Signage Displays with Plug-in Module.**

As an ENERGY STAR Partner, Newline Interactive Inc., has followed the EPA's enhanced Product qualification and certification process to ensure that the products marked with the ENERGY STAR logo are ENERGY STAR qualified per the applicable ENERGY STAR guidelines for energy efficiency. The logo appears on the pen tray near front connections on all ENERGY STAR qualified Signage Displays.

The ENERGY STAR program for Signage Displays was created by EPA to promote energy efficiency and reduce air pollution through more energy-efficient equipment in offices, classrooms and factories. One way that a product achieve this goal is by using a power management feature to reduce power consumption when the product is not in use.

For TT-6519RS and TT-7519RS, sleep mode can be initiated in a couple different ways. Users can take the action of pressing the power button on the panel for 3 seconds, or a remote command can be sent via RS232. The panel will also go into sleep mode without user action after 3 hours of inactivity.

TT-6519RS and TT-7519RS can exit sleep mode by the user pressing the power button, or by the proximity sensors detecting a user's presence, or through a remote command via RS232. In the event of a proximity detection, the panel will transition from sleep mode to another low power mode, STAND BY.

In the event that brightness settings or power mode settings are changed by the user, energy consumption of the panel may increase beyond the limits required for ENERGY STAR certification.

Additional information on the ENERGY STAR program and its environmental benefits are available on the EPA ENERGY STAR Power Management website at <http://www.energystar.gov/powermanagement>.

Additional information on the ENERGY STAR program and its environment benefits are available on the EPA ENERGY STAR website at <http://www.energystar.gov>





For production, above information will need to be available for the Energy Star V8 build from 27th January 2020.

Manufacturer-reported maximum luminance LMax Reported is 370cd/m2.

About This Document





This document describes multiple functions, instructions, and notes about the product.





Symbols are used in this document to indicate operations that need particular attention. The symbols are defined as follows:





 NOTE	Provides additional information to supplement operation in the main text.
 TIP	Provides tips for operation.
 CAUTION	Indicates a potentially hazardous situation that, if not avoided, could result in equipment damage, data loss, performance deterioration, or unanticipated results.
 WARNING	Indicates a hazard with risk that, if not avoided, could result in death or injury.



Safety Instruction

For your safety, please read the following instruction before you use the product. Serious injury or property damage may be caused by improper operations. Do not try to repair the product on your own.

 WARNING	
	<p>Disconnect the product from the power supply immediately if major failures occur. Major failures include the following:</p> <ul style="list-style-type: none"> • If smoke, a peculiar smell or an abnormal sound is discharged from the product. • No image or sound is displayed, or the image error occurs. <p>In the preceding scenarios, do not continue to use the product. Disconnect power supply immediately and contact professional staff for troubleshooting.</p>
	<p>Do not drop any liquids, metal, or anything combustible onto the product.</p> <ul style="list-style-type: none"> • If any liquids or metal are dropped onto or into the product, power off the product and disconnect the power supply. Then contact professional staff for solutions. • Pay attention to children when they are close to the product. <p>Put the product on a stable surface. An unstable surface includes, and is not limited to, an inclined plane, a shaky stand, desk or platform, that might cause the product to turnover and be damaged.</p>
	<p>Do not open the panel or change the product on your own. High voltage components are installed in the product. When you open the panel, high voltage, electric shock, or other dangerous situations may occur. If inspection, adjustment, or maintenance is required, contact the local distributor for help.</p>
	<p>Use the provided power supply.</p> <ul style="list-style-type: none"> • To prevent the product from being damaged, do not use any types of power cables other than the one provided with the product. • Use a three-wire socket and ensure that it is properly grounded. • Pull out the power plug from the socket if the product is not used for a long period. <p>Clean the power plug regularly.</p> <ul style="list-style-type: none"> • Fire or electric shock may be caused if the product is powered on while you are cleaning. • Pull out the power plug before cleaning it with a dried cloth. <p>Power output port is 5V/2A. The voltage/current of the rear power output port is 5V/2A (maximum). Purchase the power code/AC adapter according to customer needs. The port can be used for the Newline X10D Android box. Please do not connect any products with different power requirement. Otherwise, it may cause damage to products or fire.</p>

 WARNING	
	<p>Do not put items on the top of the product.</p> <ul style="list-style-type: none"> • Do not put items, such as a container for liquid (a vase, flowerpot, cosmetics, or liquid medicine) on the top of the product. • If any water or liquid is spilled on the product, the product may short circuit and cause fire or electric shock. • Do not walk on or hang any items on the product.
	<p>Do not install the product in an improper place.</p> <ul style="list-style-type: none"> • Do not install the product in humid places, such as the bathroom, the shower room, near windows, or outdoor environments that experience rain, snow, or other harsh weather. Avoid installation near hot spring vapor. The preceding environments may cause faults in the product or electric shock under extreme conditions. • Do not put an exposed fire source, such as a lit candle, on the product.
	<p>Pull out the power supply during thunderstorms.</p> <ul style="list-style-type: none"> • Do not touch the product during a lighting storm, you may experience an electric shock. • Install or place components that supply high enough voltage to cause personal injury out of the reach of children.
	<p>Do not touch the power cable with wet hands.</p>

 CAUTION	
	<p>Do not install the product in high temperature environments.</p> <ul style="list-style-type: none"> • Do not install the product near a heat source, such as a radiator, a heat reservoir, a stove, or other heating products. • Do not expose the product to direct sunlight, which may cause high temperatures and subsequent faults in the product.
	<p>When transporting the product:</p> <ul style="list-style-type: none"> • Pack the product for transport or maintenance by using the cartons and cushioning material provided with the product. • Move the product vertically during transport. The screen or other components are easily broken if the product is moved in an improper way. • Before you move the product, disconnect all external connections and separate all topple preventing products. Move the product carefully to prevent it from being hit or squeezed, especially the screen, which may cause injury if broken.
	<p>Do not cover or block up any vents on the product.</p> <ul style="list-style-type: none"> • Any overheated components may cause fire, damage the product, and shorten the service life. • Do not lay the product down in a way where the venting surface will be covered.

 CAUTION	
	<ul style="list-style-type: none"> • Do not install the product on carpet or cloth. • Do not use a cloth, such as table cloth, to cover the product.
	<p>Keep the product away from the radio.</p> <p>The product complies with the international EMI standard to prevent radio interference. However, interference may still exist and cause noise in the radio. If noise occurs in the radio, try the following solutions.</p> <ul style="list-style-type: none"> • Adjust the direction of the radio antenna to avoid the interference from the product. • Keep the radio away from the product.
	<p>If the screen glass is broken or falls off:</p> <ul style="list-style-type: none"> • Keep all personnel 10 feet away from the screen to ensure safety. • Do not perform any installation or disassembly while the screen glass is broken or has fallen off.
	<p>Use the battery correctly.</p> <ul style="list-style-type: none"> • Galvanic corrosion, electric leakage, and even fire may be caused by improper battery usage. • It is recommended to use the designated type of battery and install the battery by the correct electrodes (positive and negative). • Do not install and use a new battery with a used one. • Take out the battery if the remote control is not used for a long period. • Do not expose the battery to overheated environments, such as sunlight or heat sources. • Dispose of the used battery based on your local regulations.
	<p>Do not damage the power cable.</p> <ul style="list-style-type: none"> • Do not damage, change, twist, bend, or forcibly drag the power cable. • Do not put weights (such as the product itself) on the power cable. • Do not forcibly drag the cable when you pull out the power plug. If the power cable is damaged, please contact the local distributor to repair or replace it. • The power cable in the accessory box is for this product only. Do not use it on other products.
	<p>Additional advice:</p> <ul style="list-style-type: none"> • Use the product in an environment with comfortable lighting. It is harmful to your eyes to watch in a too bright or too dark environment. • Relax your eyes watching for a period of time. • Keep sufficient distance from the product to protect your eyes and prevent eyestrain. • Adjust the volume to an appropriate level, especially at night. • Use amplifier equipment as the audio input source with caution. If you must use amplifier equipment, the input power should not exceed the maximum of speaker power. Otherwise, the speaker can become overpowered and damaged.
	<p>About USB port.</p> <p>Front USB ports and rear USB 3.0/USB 2.0 ports switch connections based on signal sources. If the current signal source is reading the data from an external product connecting to the port, please switch the signal source after the data reading is complete. Otherwise, the data or product may be damaged.</p>

1 Overview

1.1 Introduction

Take collaboration to the next level with the RS interactive display.

Increase productivity and collaboration across the board with a display that uses advanced touch technology.

Each product can be customized to fit your needs. The non-proprietary nature lets you use the software you prefer, take notes on local files, wirelessly cast to the screen from smaller devices, run your favorite apps, and view multimedia files, all while making your experience better than before.

The newline's 4K Ultra High-Definition LED screen also provides a fluid writing experience. Annotate over anything on the screen, whether in the embedded whiteboard or while using any other device. IntelliTouch automatically identifies pen thickness and color, saving you time.

1.2 Parts

- Front View

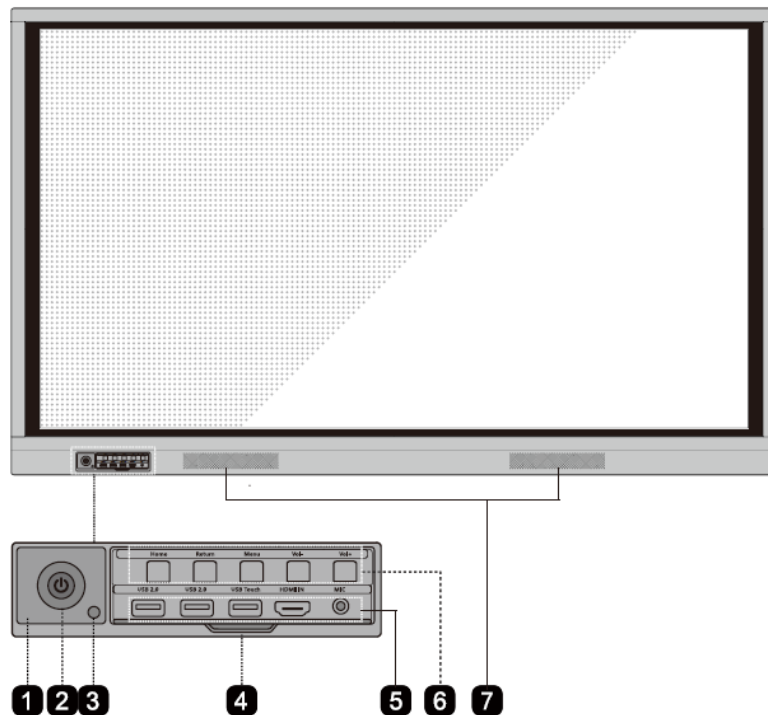

- Rear View

65 inch:

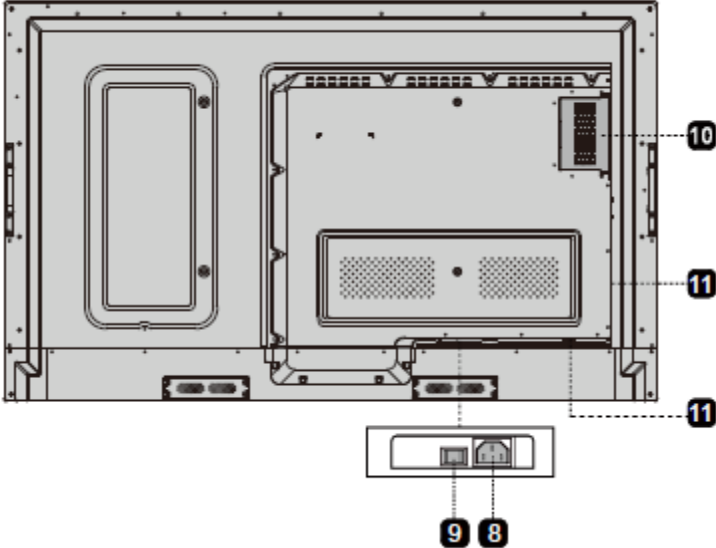

75 inch/86 inch:

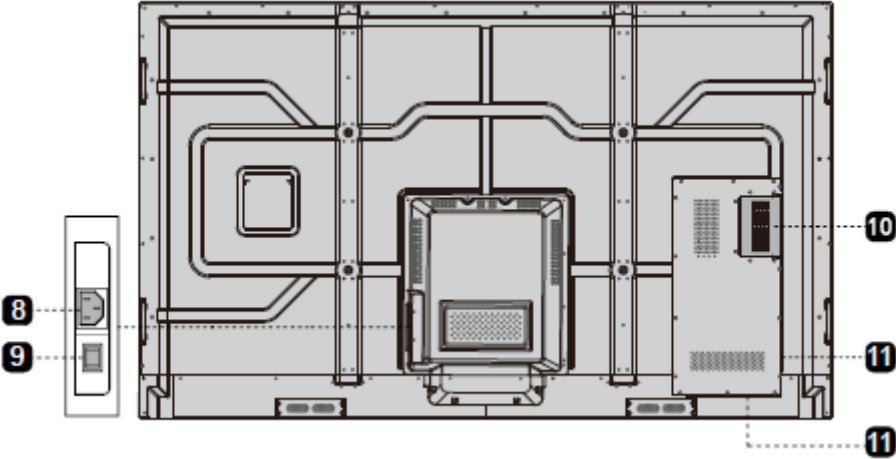

1	Remote Control Receiver	7	Speakers
2	Power On/Off	8	Power Supply Plug
3	Light Sensor	9	Power Switch
4	Front Plate Cover	10	Internal PC Port (OPS)
5	Front Ports	11	Rear Ports
6	Front Buttons		

1.3 Ports

Front Ports



CAUTION

Front USB ports and rear USB 3.0/USB 2.0 ports switch connections based on signal sources. If the current signal source is reading the data from an external product connecting to the port, please switch the signal source after the data reading is complete. Otherwise, the data or product may be damaged.

For USB consumption, USB 2.0 provides up to 500ma whereas USB 3.0 provides up to 900ma. Kindly please make sure your USB flash drive which inserts to the display port is FAT32 format .

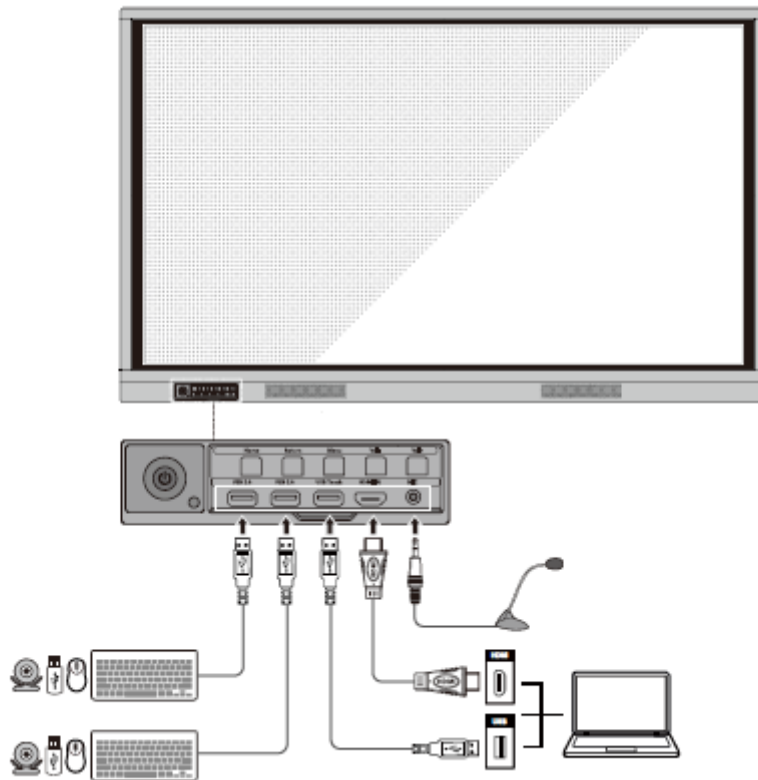

Rear Ports



WARNING

The voltage/current of the rear power output port is 5V/2A (maximum). Purchase the power code/AC adapter according to customer needs. The port can be used for the Newline X10D Android box. Please do not connect any products with different power requirement. Otherwise it may cause the damage to products or fire.

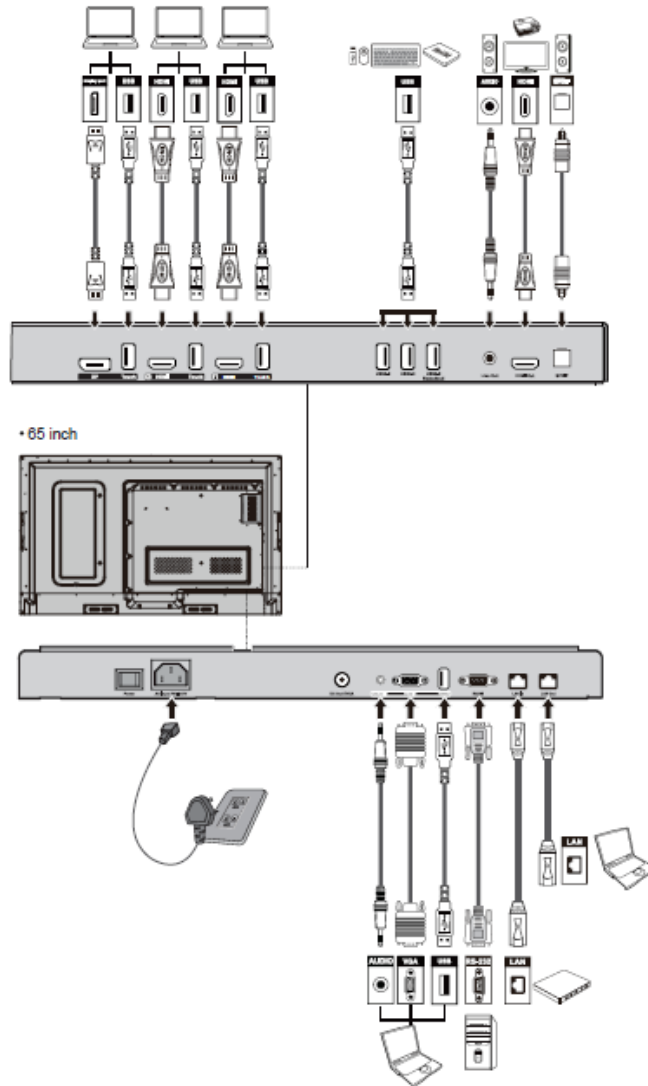

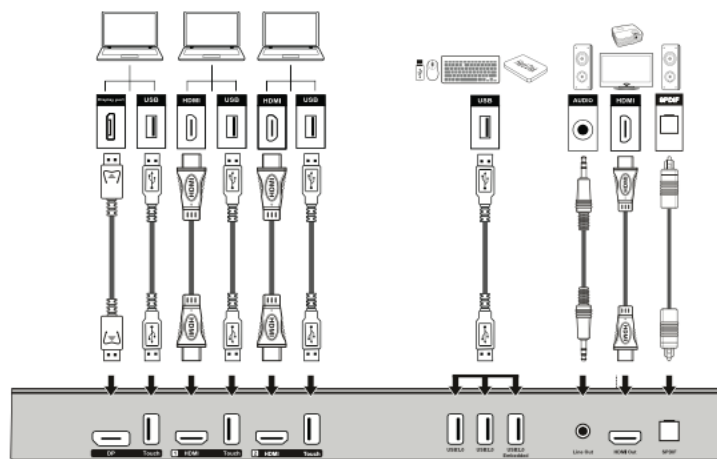

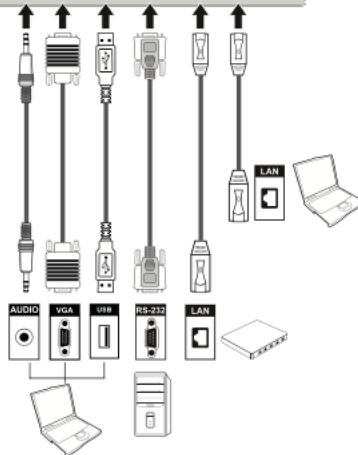
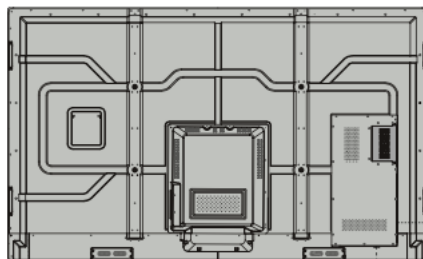

• 75 inch / 86 inch

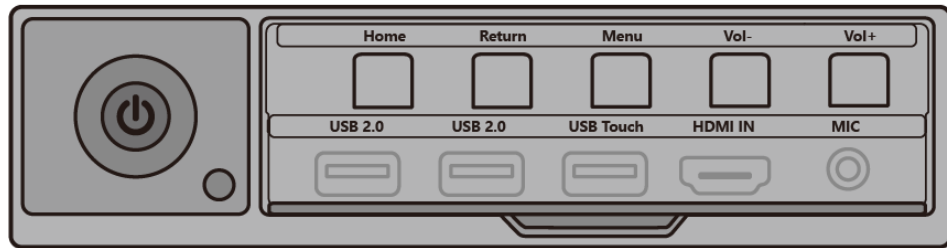

Front Buttons



Buttons	Operations	Functions
	Short press	Power on/off <ul style="list-style-type: none"> • Steady red color: Display is in shut down mode • Steady white color: Display is on and working
Home	Short press	Go to the home page
Return	Short press	Return to the last menu/Exit
Menu	Short press	Open the Settings menu
	Long Press for More than 2 Seconds	Lock the screen
Vol-	Short press	Decrease the sound volume
	Long press for more than 1 second	Continuously decrease the sound volume
Vol+	Short press	Increase the sound volume
	Long press for more than 1 second	Continuously increase the sound volume

1.4 Remote Control









Carefully read the following instructions before using the remote control to avoid possible faults:

- Do not drop or damage the remote control.
- Do not spill water or other liquids on the remote control.
- Do not place the remote control on a wet object.
- Do not place the remote control directly under sunlight or near a heat source.

Buttons	Operations
	Power On/Off
	Mute/Unmute Audio
0-9	Enter number
	Go to the Home Page
	Return to Previous/Exit
	Up/Down/Left/Right
	Confirm/OK
	Enter Whiteboard Mode
	Take a Screenshot
	Enable Sound Only Mode
	Freeze the Current Screen, Click Again to Exit Freeze Function
	Adjust the Sound Volume
	Adjust the Brightness
	Enter the Source Selection Page
	View Currently Running Applications
	Open the File Manager



Buttons	Operations
	View all Pre-installed Applications
PC	Switch Source to Internal PC
DP	Switch Source to Display Port
HDMI FRONT	Switch Source to HDMI Front
HDMI 1	Switch Source to HDMI 1
HDMI 2	Switch Source to HDMI 2
VGA	Switch Source to VGA
	Autocorrection Screen Display (For VGA Signal Source)
	Open the Browser Application
	Toggle Display Backlight Mode
	Start/Exit the Screen Lock Function
	<ul style="list-style-type: none"> • Open the Menu (Short Press) • Screen Lock (Long Press for More than 2 Second)
	Open the System Settings

2 Installation Guide

2.1 Safety Precautions

Installation Environment



Installation Direction

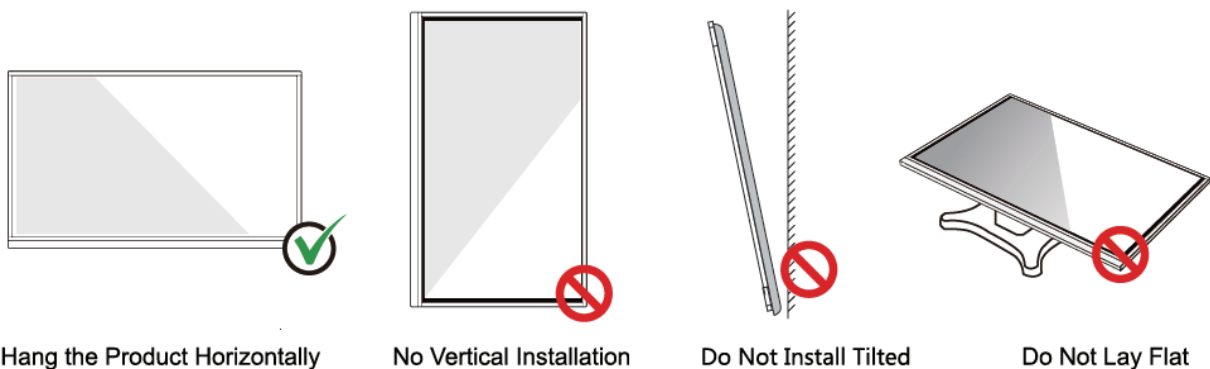

2.2 Installation Precautions

Weight Loading

Weight of the product: 161lb/ 72 kg (86 inch), 123lb/56 kg (75 inch), 97lb/ 44kg (65 inch)

- When using a mobile stand, ensure that the weight of the product is less than the loading capacity of the mobile stand.
- When using the wall-mount bracket, ensure that the wall can support the weight of the product. We recommend that the wall surface be reinforced and have a loading capacity 4 times of the weight of the product. Consult a professional installer for wall-mount installation.

NOTE

The company does not undertake relevant legal responsibility for any problems caused by improper operation if the third party mobile stand, or wall-mount bracket is beyond the scope of the product.

- Do not install the product where it might be hit by an opening or closing door.

Vertical installation

When installing, try to keep the product vertical. An excessive tilt angle may cause the screen glass to falloff or the product to collapse.

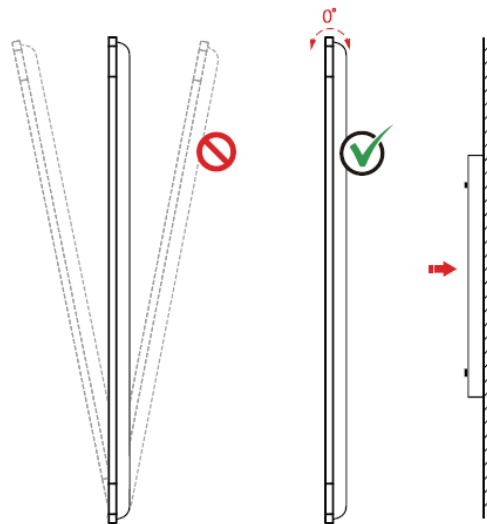

NOTE

For any problem, please contact our support desk. Our company is not responsible for any damage or losses incurred by users if the users fails to follow the instructions.

Ventilation

Ensure adequate ventilation and/or an air conditioned environment. We recommend keeping certain distances from the side of the product to the wall or panels. Ventilation requirements are shown in following figure:

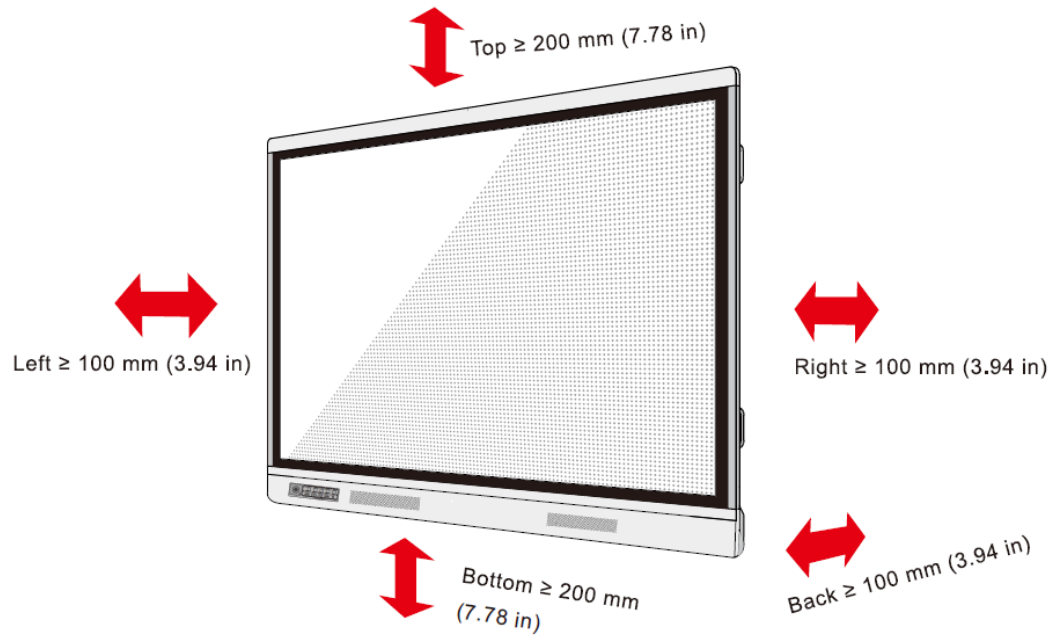

2.3 Installation

The dimensions of the four bracket mounting holes on the back panel are VESA MIS-F compliant (86 inch or 75 inch: 800 x 400 mm/31.50 x 15.75 in; 65 inch: 600 x 400 mm/23.62 x 15.75 in). Use metric M8 screws with a length of 10 mm to 15 mm (0.40 to 0.59 in) to secure the touchscreen to the mounting system. Dimensions of the mounting holes on the back panel are shown on the following figure:

NOTE

Consult a professional installer to install the display product.

This apparatus is intended to be supported by a GS Listed wall-mount bracket.

86 inch/75 inch:

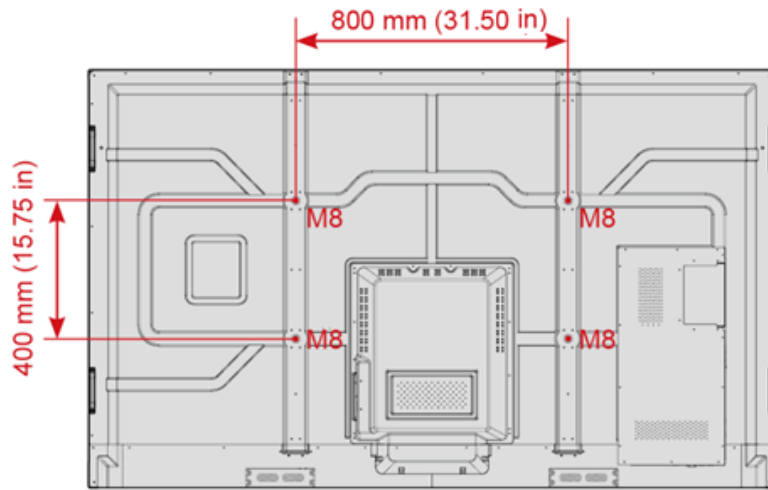

65 inch:

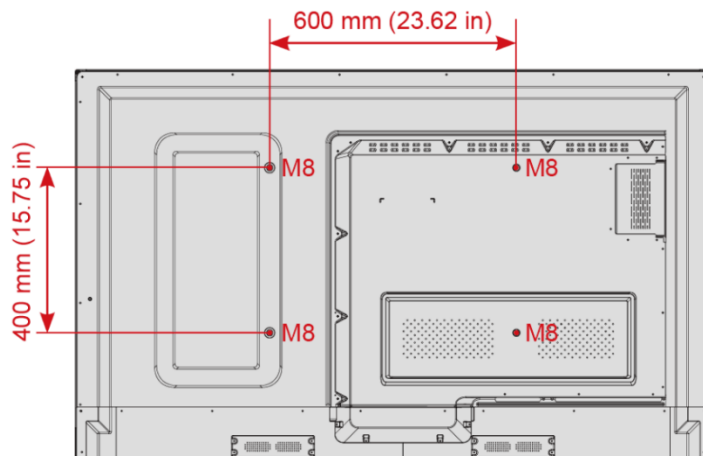

2.4 Installing the Internal PC (Optional)



The internal PC does not support hot plugging. Therefore, you must insert or remove the internal PC when the display is powered off. Otherwise, the display or internal PC may be damaged.

You will need to purchase the internal PC separately. Perform the following steps to install the internal PC:

Step 1 Unscrew the M3 screws by hand to remove the internal PC shielding cover.

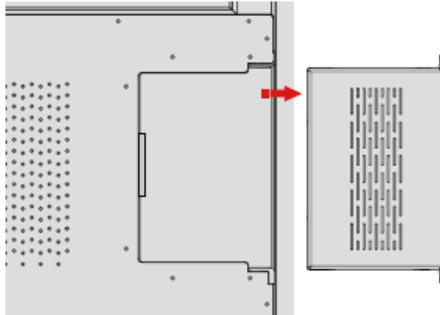

Step 2 Push the internal PC into the port at the rear of the screen from right to left.

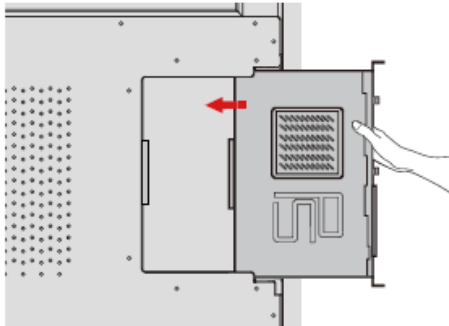

Step 3 Secure the internal PC to the display by using the M3 screws.

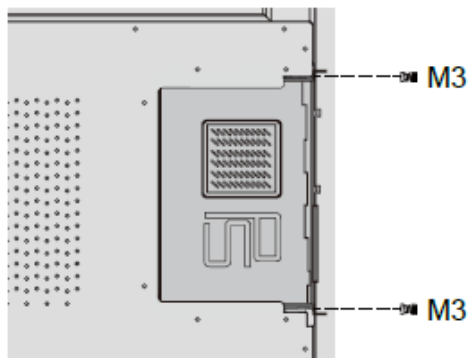

Step 4 Ensure the installation is correct before turning the power on again.

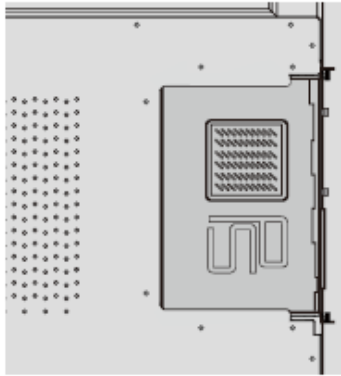

2.5 Installing Newline Assistant

Introduction

The Newline Assistant is the tool used as a bridge between the embedded operating system and the Internal PC (OPS). It helps add Windows software shortcuts to the Home Page, as well as to protect USB data when switching between sources.

Therefore we strongly recommend users install the Newline Assistant after installing the internal PC.

Installation

- Step 1** Install the Internal PC correctly.
- Step 2** On the **Home** Page, click **Windows**. It will switch the signal source to the Internal Windows system.
- Step 3** Visit our website at www.newline-interactive.com and choose **Products** > RS series > **Download** to download the Newline Assistant installation package.
- Step 4** Install the Newline Assistant as instructed.

3 Getting Started

3.1 Power On

Step 1 Plug the power supply into the power outlet fully and plug the power connector into the side of the product. Ensure the power supply is in the range of 100V to 240V with frequency at 50 Hz/60 Hz \pm 5%. The power current must be grounded.

 **NOTE**

The power outlet should be installed near the equipment and should be easily accessible.

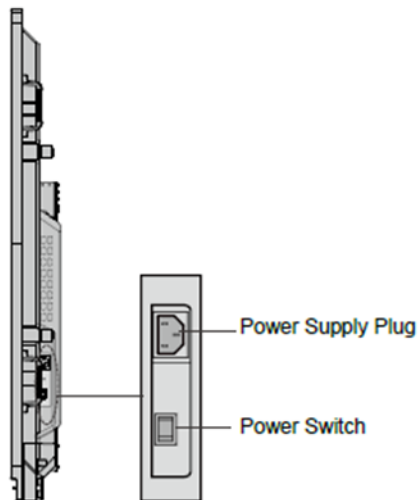

Step 2 Flip the power switch located on the side of the product to “On”.

• 75inch/86inch



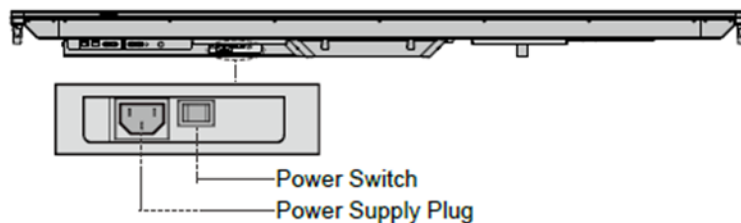



• 65inch



Step 3 Press the power button  on the front control panel or  on the remote control.

3.2 Power Off

Step 1 Press the power button  on the front panel or the power button  on the remote control.

Step 2 Press the power button  on the front panel or the power button  on the remote control again, the power indicator will turn to red.

Step 3 If you are not going to use the product for an extended period of time, we recommend you switch the power switch to “Off”.

 **NOTE**

- If an internal PC is equipped, the internal PC and the screen are powered off simultaneously when you power off the display.
- Do not forcibly disconnect the power supply of the screen when the internal PC is on.

3.3 Calibration

If the cursor position has a big deviation from the actual touch point, calibration is used to eliminate the deviation. Calibration is required in the following scenarios:

- The internal PC is used.
- A computer is connected through the HDMI or Display Port interface.

 **NOTE**

Interface operation on the embedded operating system does not need positioning. External products with Microsoft Windows 7 or later versions will require positioning.

If the positioning is not correct, perform the following operations to calibrate again. The following takes Windows 10 as an example:

Step 1 Ensure that the HDMI or DP interface and external products are connected properly.

Step 2 Select the corresponding Windows signal from the signal source menu. The Windows page will be displayed.

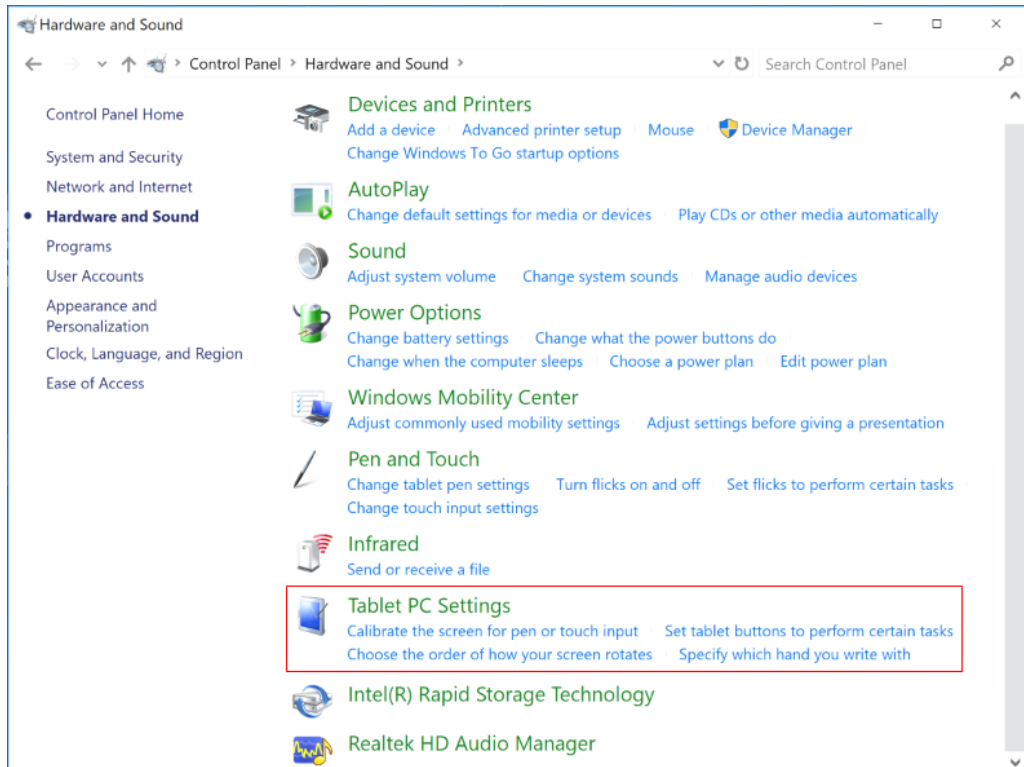

Step 3 Select **Tablet PC Settings** on the **Control Panel** page.

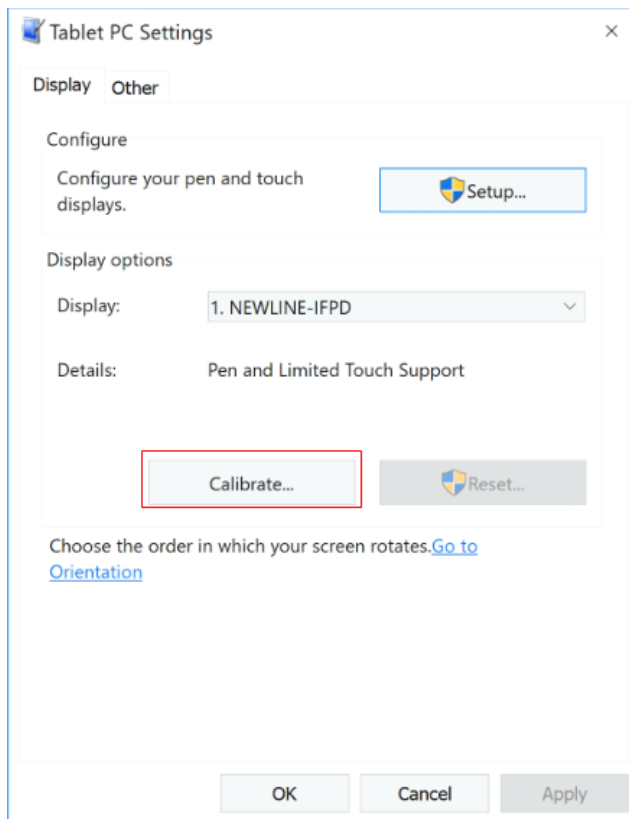

Step 4 Select  in the Tablet PC Settings window.



Step 5 Select **Touch input** from the option and start calibration.

Step 6 Use your finger or a pencil to click and hold the center of the flickering crosshair . Do not release until  moves to the next positioning point. Complete the calibration process as instructed.

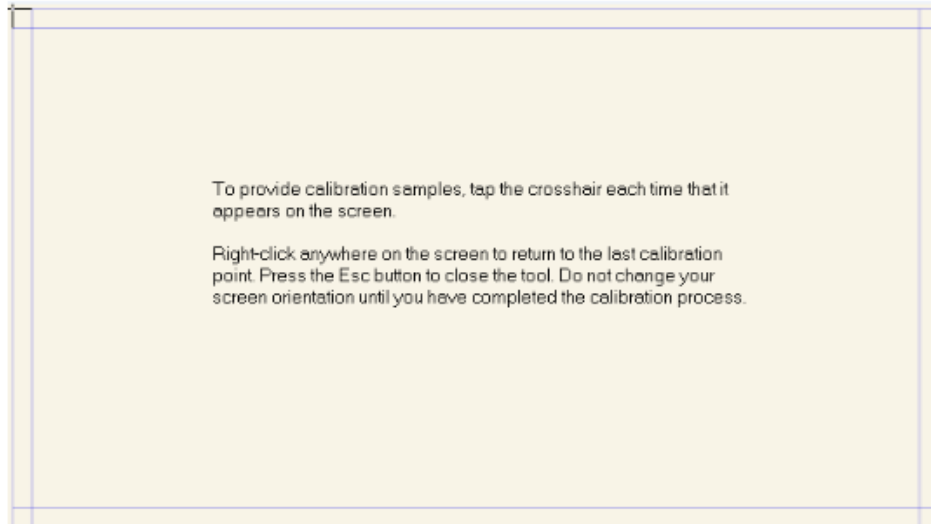

Step 7 After the calibration is complete, the **Digitizer Calibration Tool** dialog box will be displayed. Click **Yes** to save calibration data.

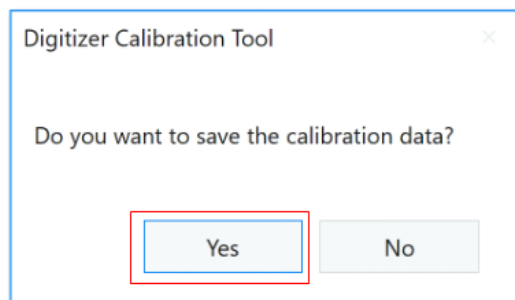

 **TIP**

- To ensure writing accuracy, use the pencil or stylus included with the product for proper positioning.
- Positioning errors may cause failure of touch functions of the display. In that case, please perform calibration again.

Step 8 The **Tablet PC Settings** dialog box will be displayed again. Click **OK**. The calibration will be complete.

4 Operating the Touch Screen

4.1 Start Screen

When the product is turned on, the product will show the Start Screen page, as shown in the following figure:

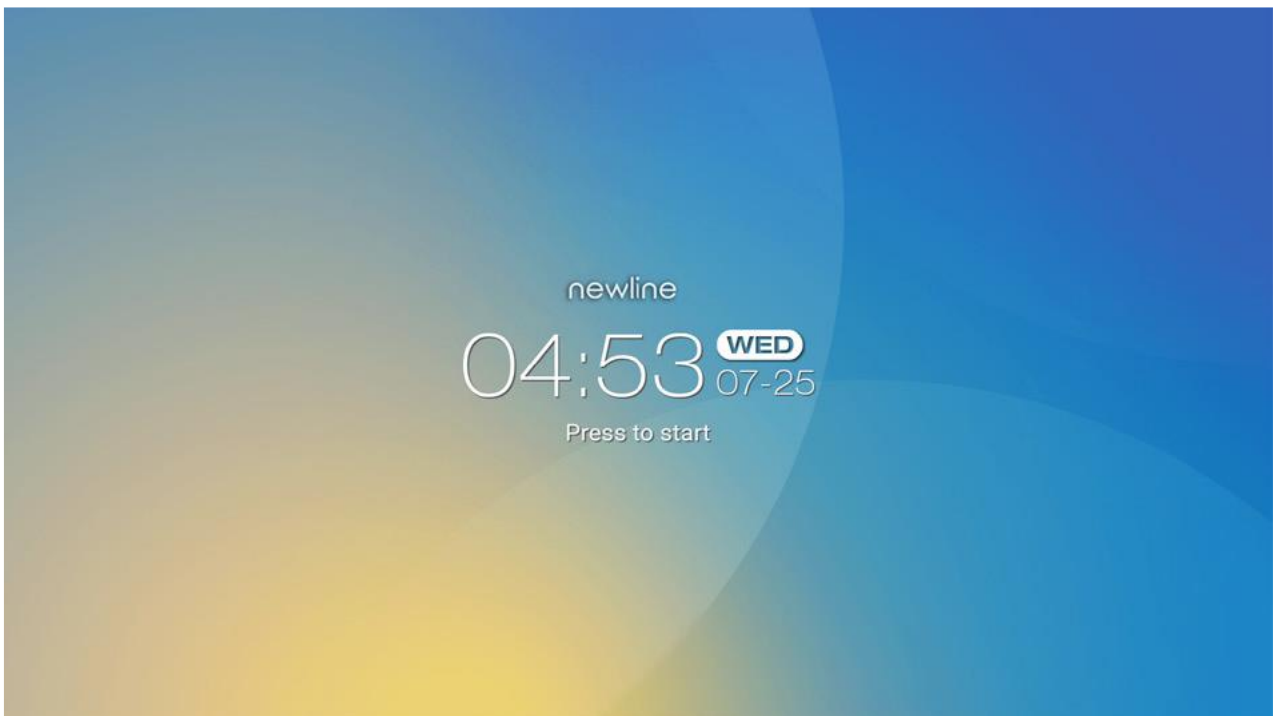

4.2 Home

Touch anywhere on the Start Screen to start a meeting, and the product will go to the **Home** page, as shown in the following figure:

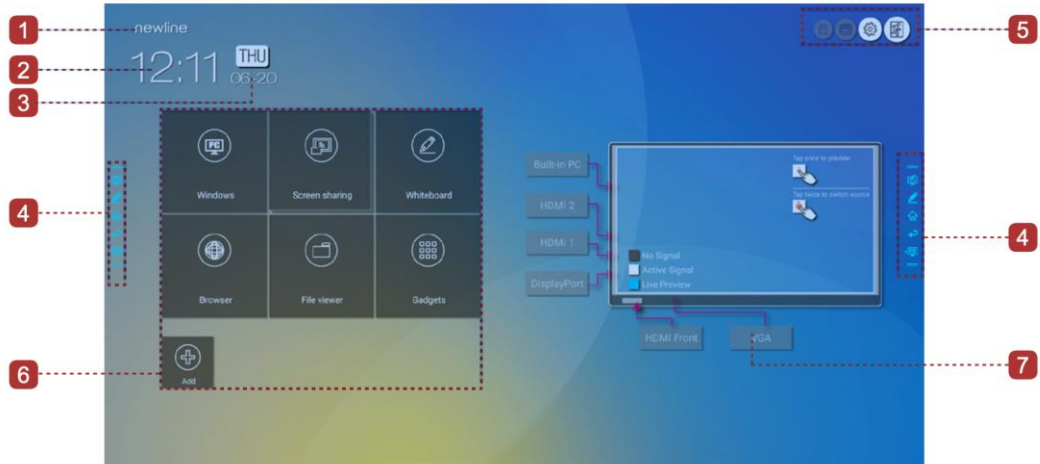

1 Logo (Shortcut to Settings)

2 Clock (Shortcut to Clock)

3 Date and Week

4 Side Toolbar

5 Status Bar and Settings

6 Main Icon

7 Preview Window for Signal Source

Shortcut for Display & Theme Settings

Click the  icon on the **Home** Page to enter the **Display & Theme** setting page to set the logo image and wallpaper. The logo and wallpaper can be obtained locally or from a device connected via the USB port, as shown in the following figure:

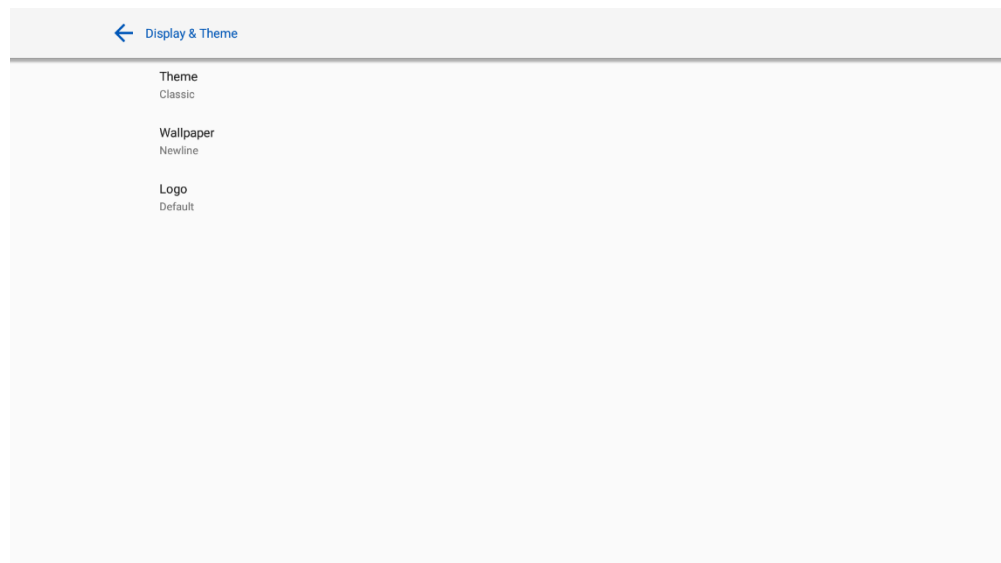

Shortcut for Clock

Click the time icon on the **Home** page to start the clock application. Using the icons on the top left, you may switch from clock mode to alarm mode, or to timer and stopwatch mode. In the clock mode, you may click  to add other time zones as shown in the following figure:

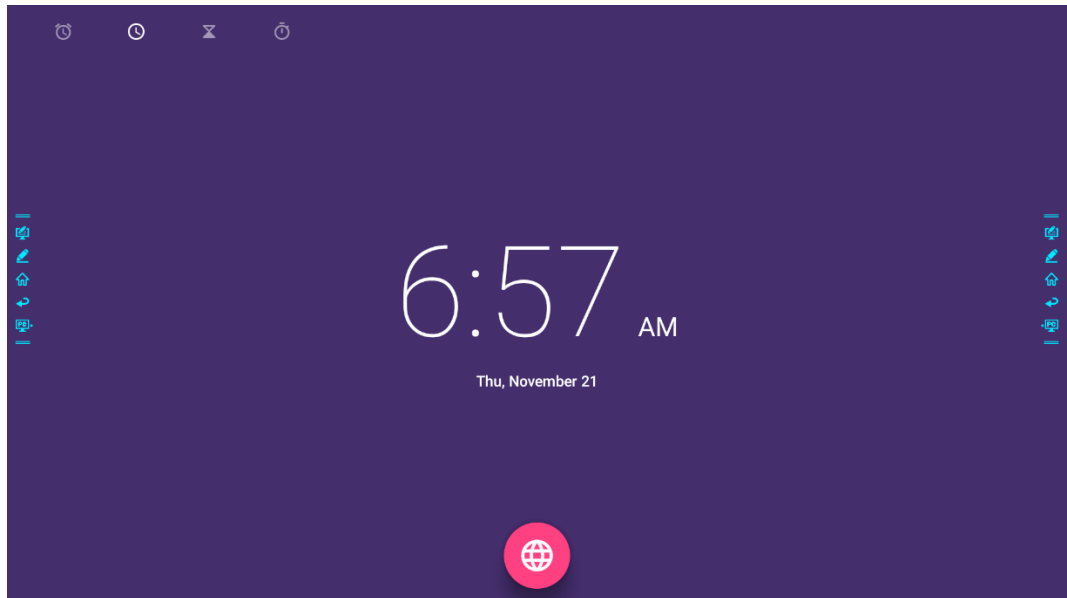





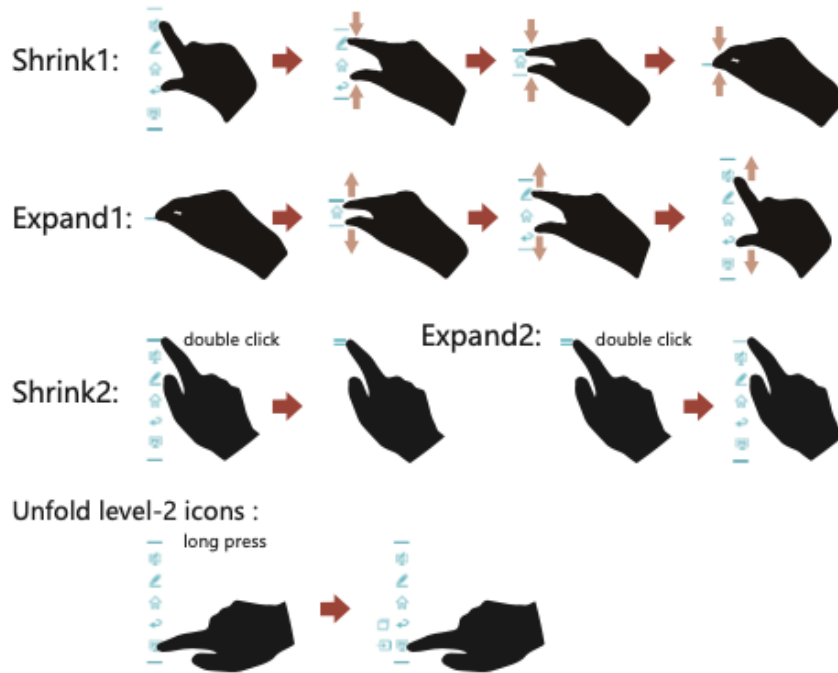

Side Toolbar

The Annotation Mode, Whiteboard, Home, Return, and Windows icons are displayed by default in the toolbar on both sides of the screen. You may hide one or both side toolbars in the Settings or move it up and down on the screen, shrink or expand by using touch gestures. You may double-tap the “=” to expand or shrink the toolbar. Long press the customized icon to unfold level-2 icons.







The functions of the side toolbar are as follows:

Icon	Functions
	Enter annotation mode, and click again to stop annotation and take a screenshot.
	Access discussion mode.
	Go to Home page.
	Return to the previous menu/Exit an app
	Go to the internal PC source.
	Manage currently running applications. Slide up/down the currently running application or click “×” at the upper right corner to close the application.





Icon	Functions
	Go to your favorite source. You can set favorite source in the “ Tool bar ” submenu in the system settings.





Status Bar and Settings

The upper right corner of the home page displays three working status icons (including USB drive(s), Ethernet, and Wi-Fi, system setting shortcut and return to the start screen page).

Icon	Functions
	If a USB flash drive is connected to the USB port, this icon will appear.
	If the product is connected to Ethernet, this icon will appear.
	If the product is connected to a wireless network, this icon will appear.
	Access the system setting page.
	Return to the Start Screen page.



Main Icon

Icon	Functions
	Switch to the internal PC source.
	Click “Screen Sharing” to enable the wireless screen sharing function. Note: By default, the “ Screen sharing ” icon is displayed after startup. When you click “ Add ” or “ Gadget ” icon, “ Screen sharing ” switches to the “ Connection ” icon.
	Click Connection to switch to the connected sources, including in the internal PC, HDMI 1, HDMI 2, Display Port, HDMI Front and VGA.
	Discussion takes you to the whiteboard function and screen annotation functions.

Icon	Functions
	Click to enter a quick-access browser.
	Open the File Manager to explore internal and external files on the display.
	Gadget displays all pre-installed applications, including Gallery, Browser, Music, Calculator, E-mail, File Viewer, Keyboard, Office Viewer and Newline Cast etc. Click the icon of an application to run the application.
	Click Add to customize the Home page. You can add up to 5 shortcuts to your favorite software, gadgets, or connections. (See more detail in “Add Shortcuts to Home Page”)

4.3 System Settings

Enter the System Settings page using one of the following methods:

- Click  on the **Home** page.
- Press  on the remote control.
- In the **Quick Settings Menu**, click the  icon.

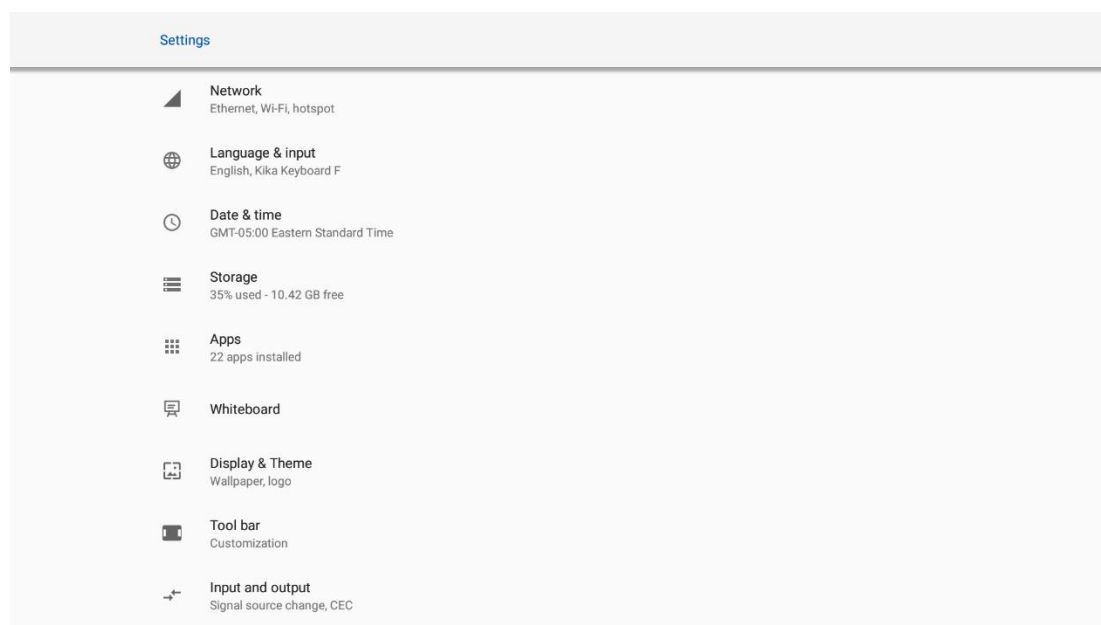

4.3.1 Network Settings

Enter the **Network** submenu to set a LAN, Ethernet, Hotspot&tethering, Proxy, enable Wi-Fi function.

- **Wi-Fi:** Click the corresponding button to enable the Wi-Fi function. Press again to see the available Wi-Fi list.
- **Ethernet:** Click to open ethernet settings.
- **Hotspot&tethering:** Click to set up Wi-Fi hotspot.
- **Wake on LAN:** turn on/off LAN.
- **Proxy:** The settings of the proxy server.

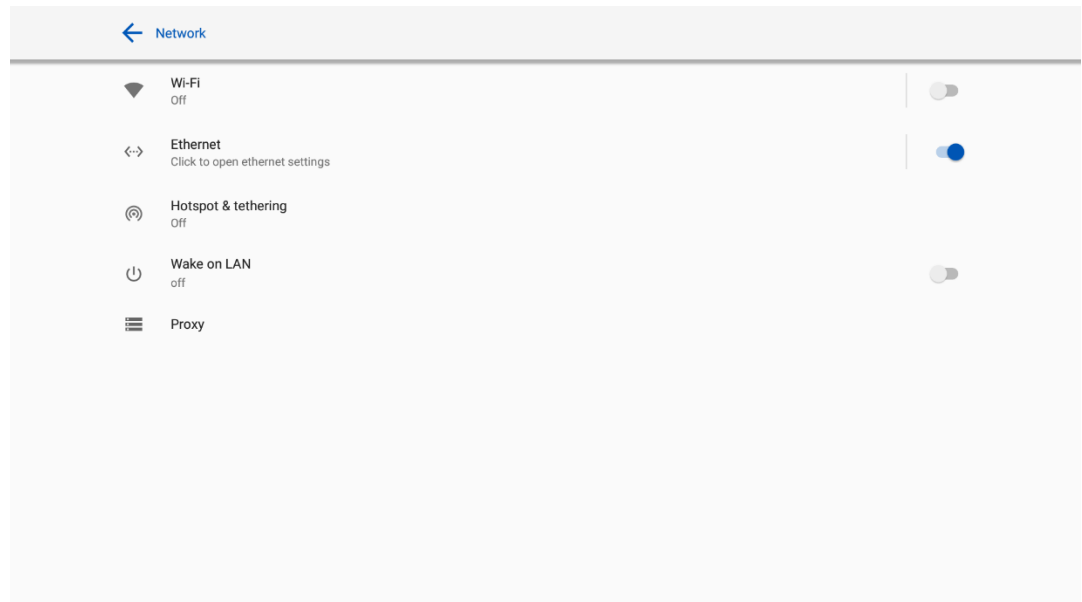

4.3.2 Language and Input Settings

Enter the **Language & Input** submenu to set the language and keyboard settings.

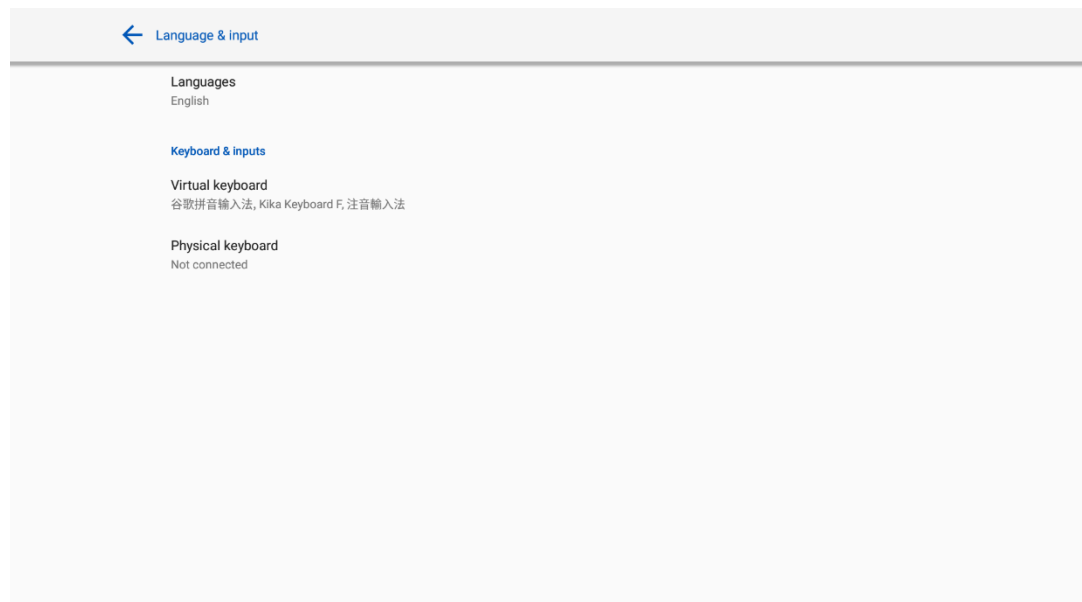

Settings

The default input method of the system is **Kika Keyboard F**, and the Physical keyboard must be enabled. If you want to switch to another language, switch the keyboard input method via **Manage keyboards** methods, in addition to switching the language.

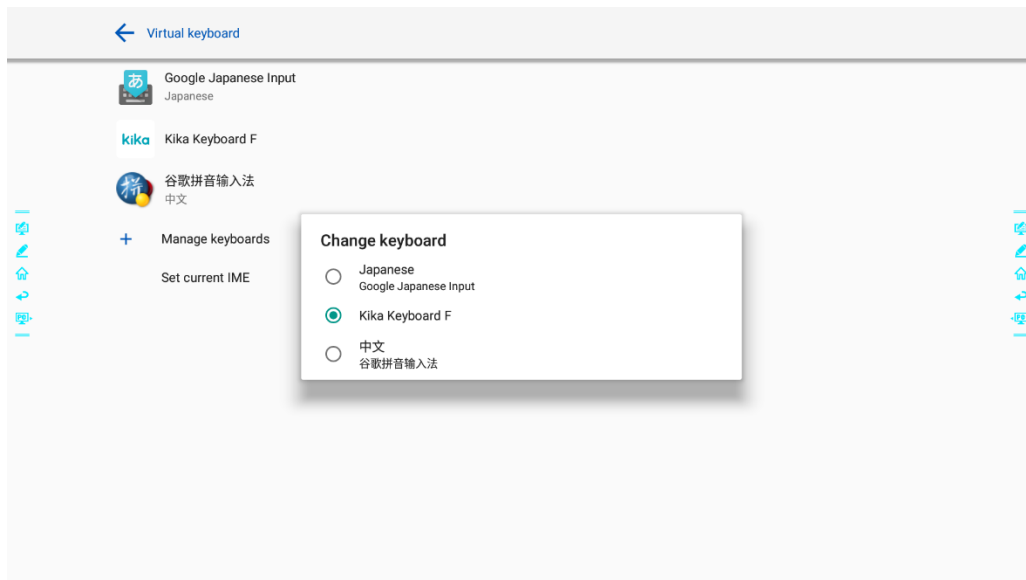

00

Setting a Language

Click **Languages** on the **Language & Input** interface. In the **Languages** dialog box that is displayed, select your preferred language.



Adding an Input Method

Click **Manage keyboards** on the **Virtual Keyboard** interface. On the **Manage keyboards** page, select the input methods you would like to use (multiple choices can be selected).

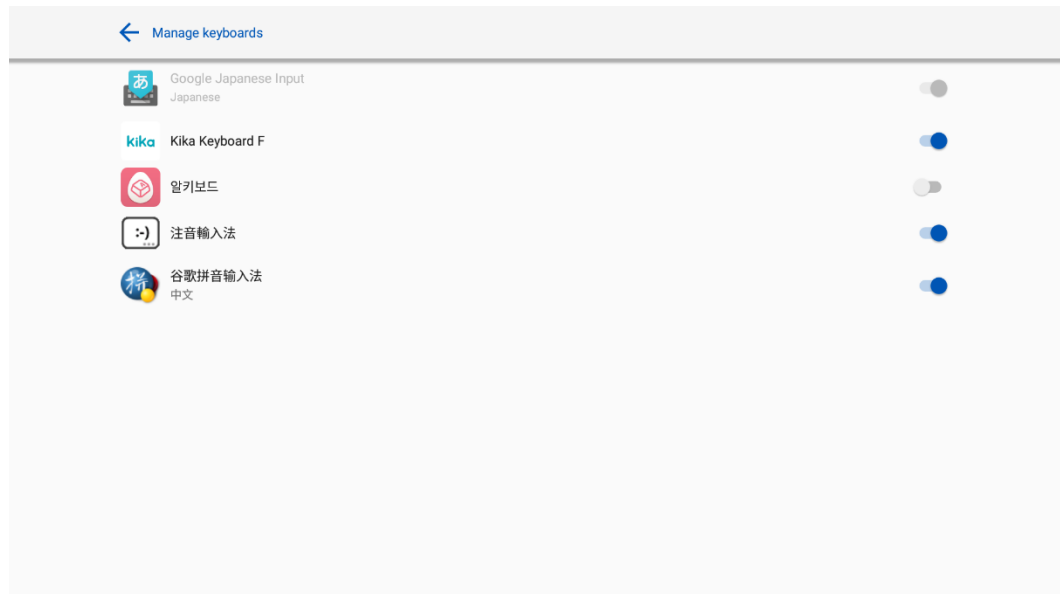

4.3.3 Storage

Enter the **Storage** submenu to view space distribution of the internal storage.

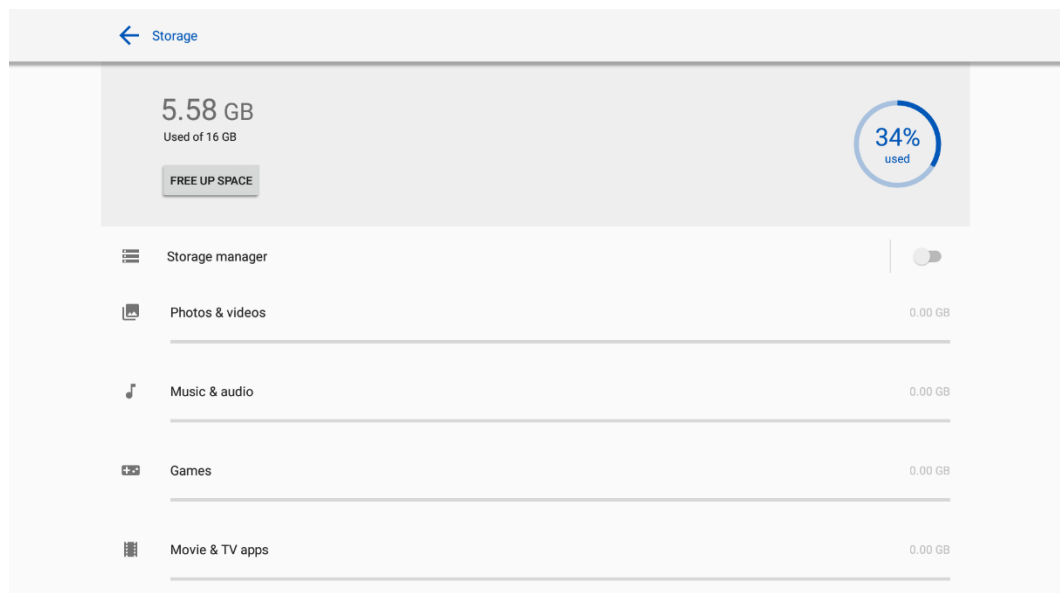

4.3.4 Applications

Enter the **Apps** submenu to view all downloaded applications by type, running applications, and a summary of all applications.

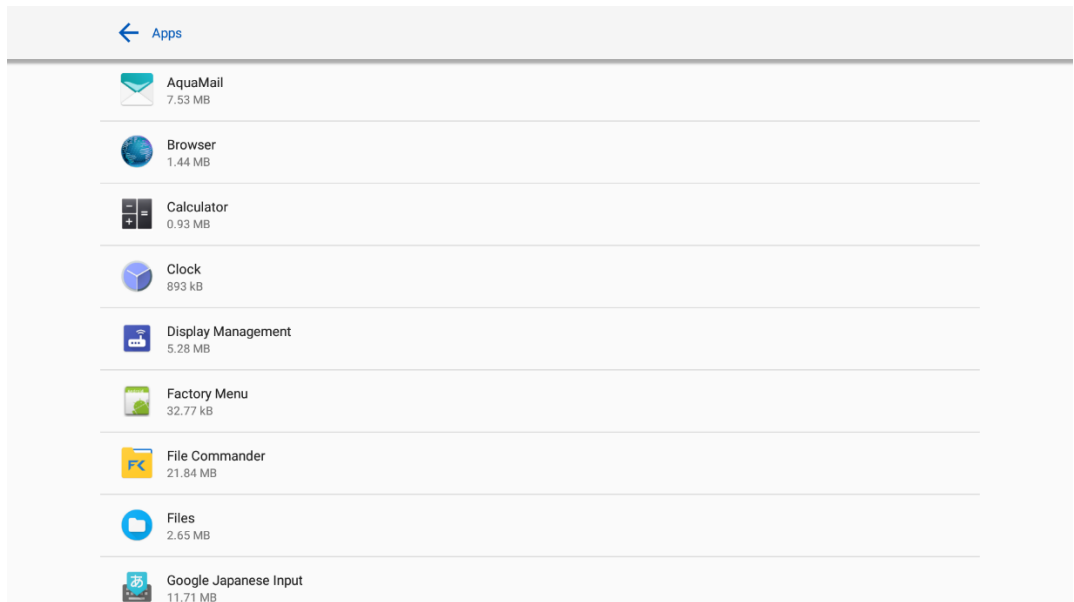

4.3.5 Whiteboard

Enter the **Whiteboard** submenu to set the version of whiteboard.

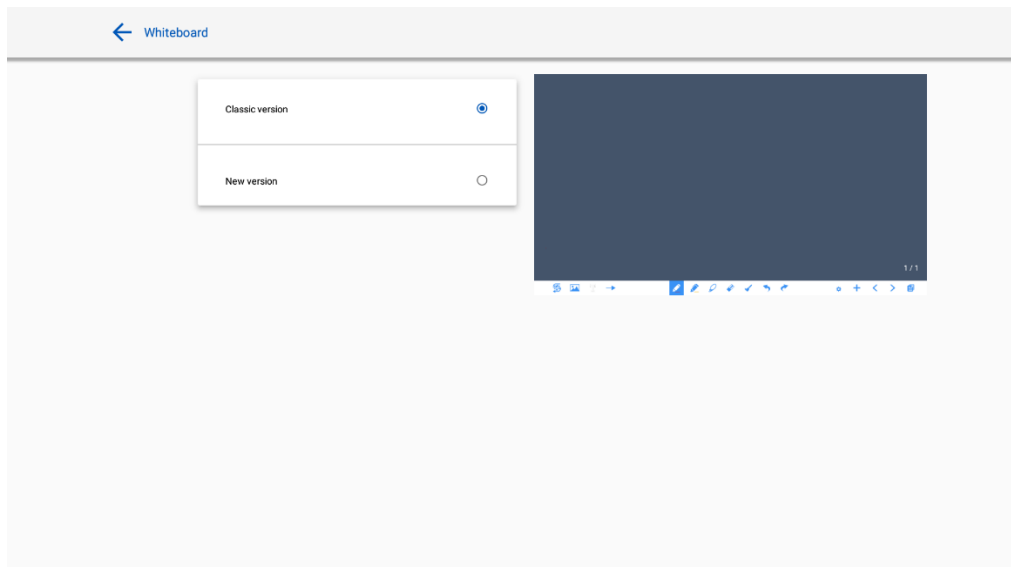

4.3.6 Smart Eye Protection

Enter the **Smart eye protection** submenu to set **Eye protection writing mode**, **Eye protection brightness control mode** and the **Bluelight filter**. If only the Bluelight filter setting is on, the filter level can be set.

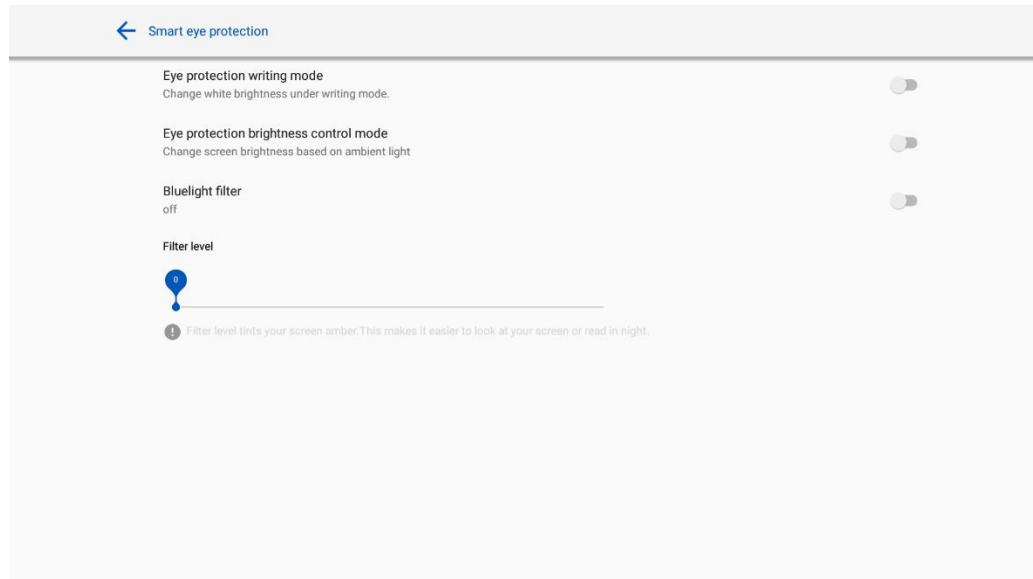

4.3.7 Date and Time Settings

Enter the **Date & Time** setting submenu to set the date and time. Before setting the date and time, users should click **Select time zone** to set everything to the local time zone.

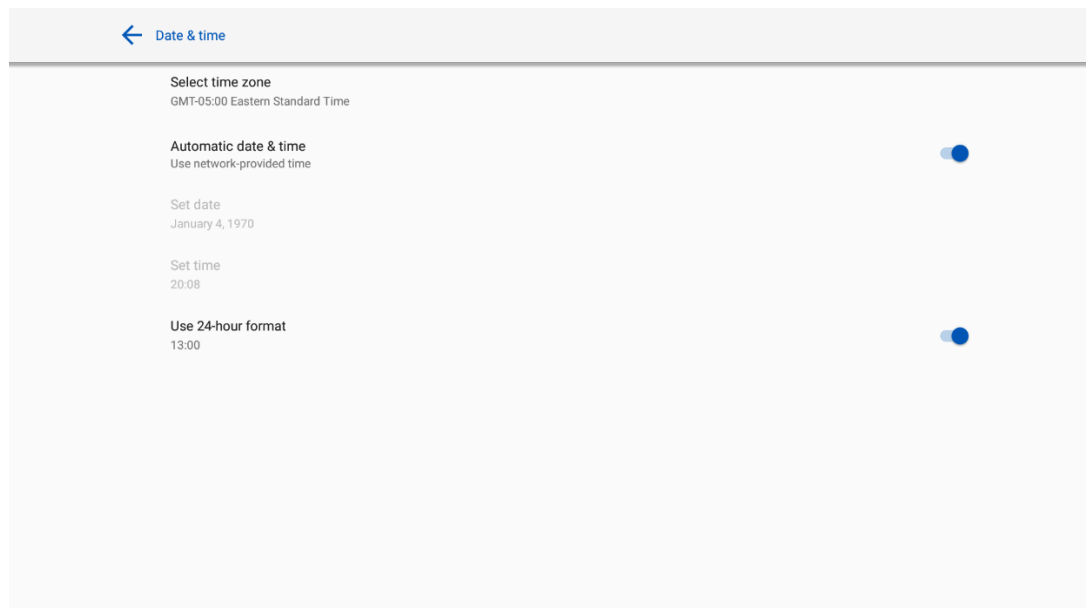

Date Settings

You can automatically obtain the date .

- To automatically obtain the date, select **Automatic date & time**.

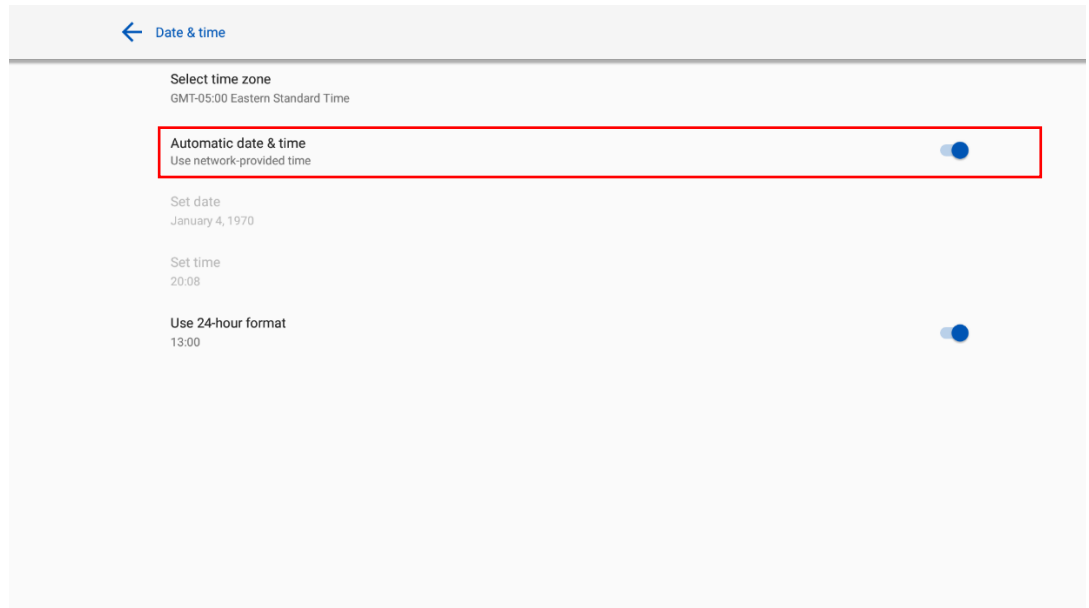

Time Settings

You can automatically obtain the time.

- To automatically obtain the current time, select **Automatic date & time**.

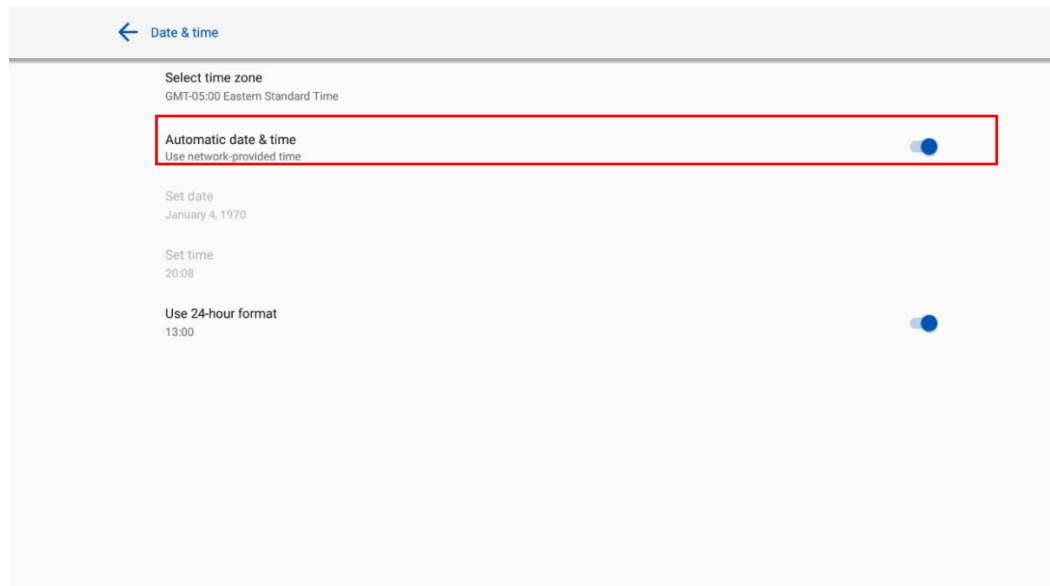

- To customize time and time format, set them in **Set time** and select **Use 24-hour format**.

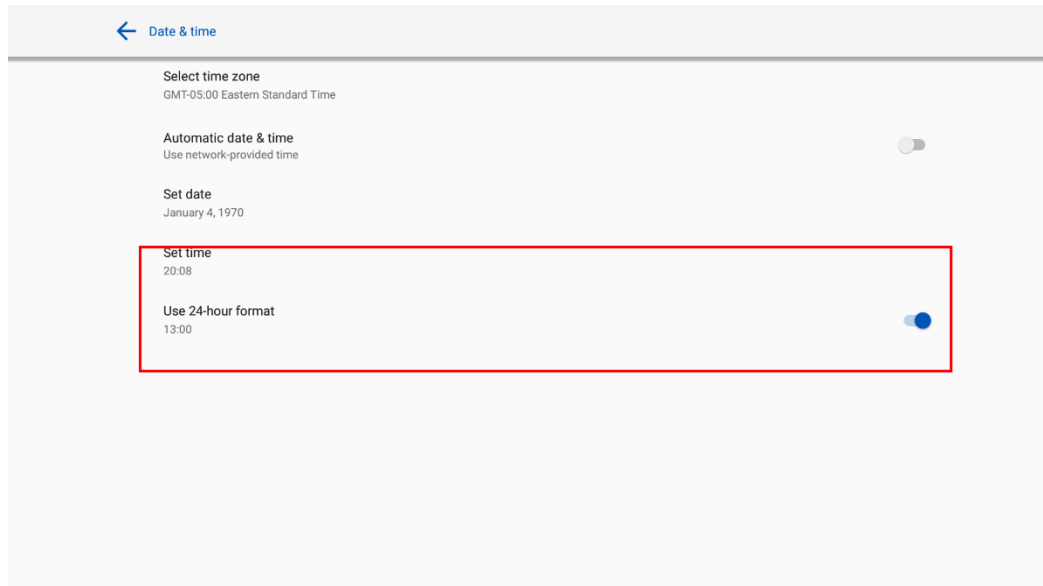

4.3.8 Power Settings

Enter the **Power** setting submenu to set an automatic power on/off time and the time for the system to enter energy saving mode.

- To set the automatic power on time, select **Auto power on**, and the time you want the display to turn on in **Power on time**, as shown in the following figure:

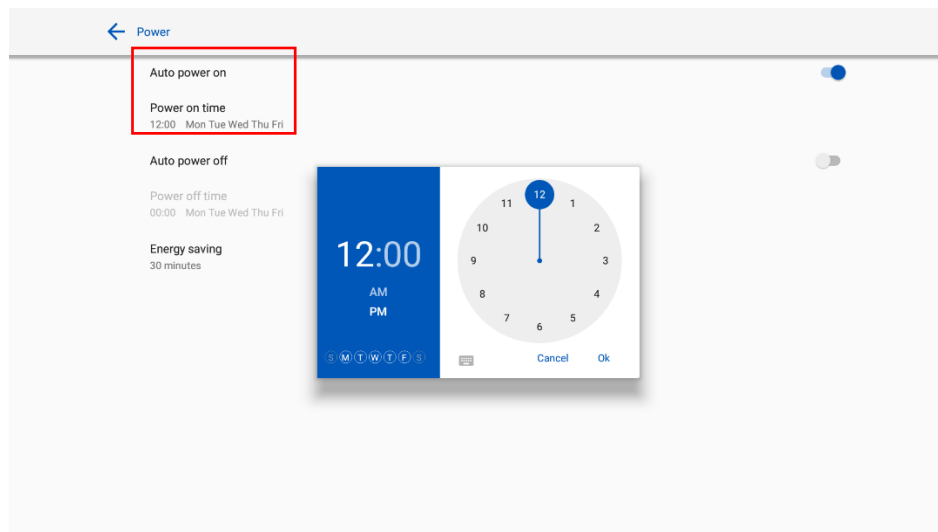

- To set the automatic power off time, select **Auto power off**, and set the time you would like the display to turn off in **Power off time**, as shown in the following figure:

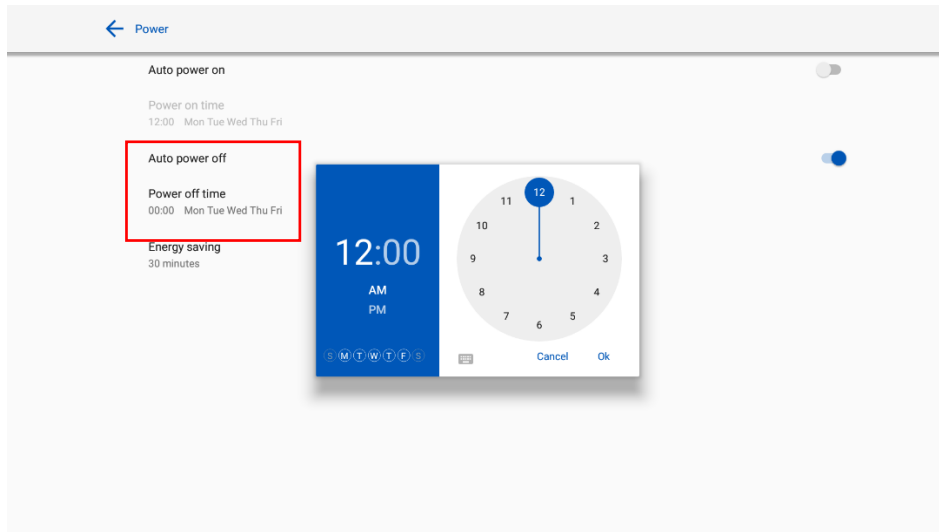

- To set the energy saving time, click **Energy saving**. In the dialog box that is displayed, set a duration after which the screen enters the lock mode if the screen is left un-operated. After the screen is locked, if the user does not operate the screen within 120s, the screen enters the shut down mode. The duration can be set to **30 mins**, **60 mins**, **90 mins**, or **Never**. You can also customize this duration and the range is 3 minutes to 480 minutes.



NOTE

NEVER indicates that the automatic shut down mode function is not enabled.

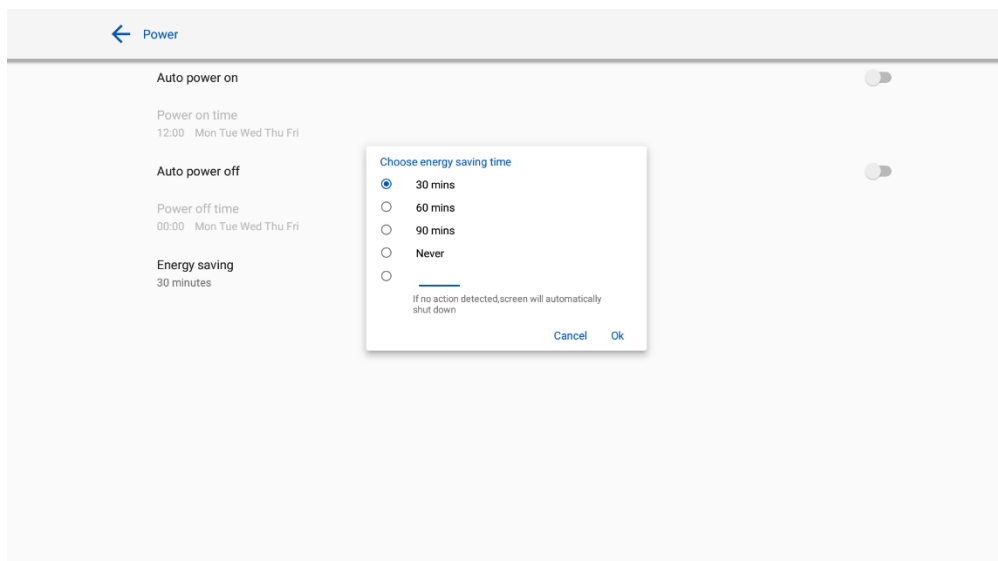

4.3.9 Tool Bar Settings

Enter the **Tool bar** submenu to set whether to display the side tool bar and icons.

- Left: Click to turn on/off the left tool bar.
- Right: Click to turn on/off the right tool bar.
- Customized icon: Click the icon under **Customized icon** to display the last shortcut key on both toolbars. If you define the shortcut key as **Connection**, you can set a signal source to enter after this shortcut key is clicked in **Favorite Connection**.

- **Quick settings:** Click to turn on/off the quick settings function.

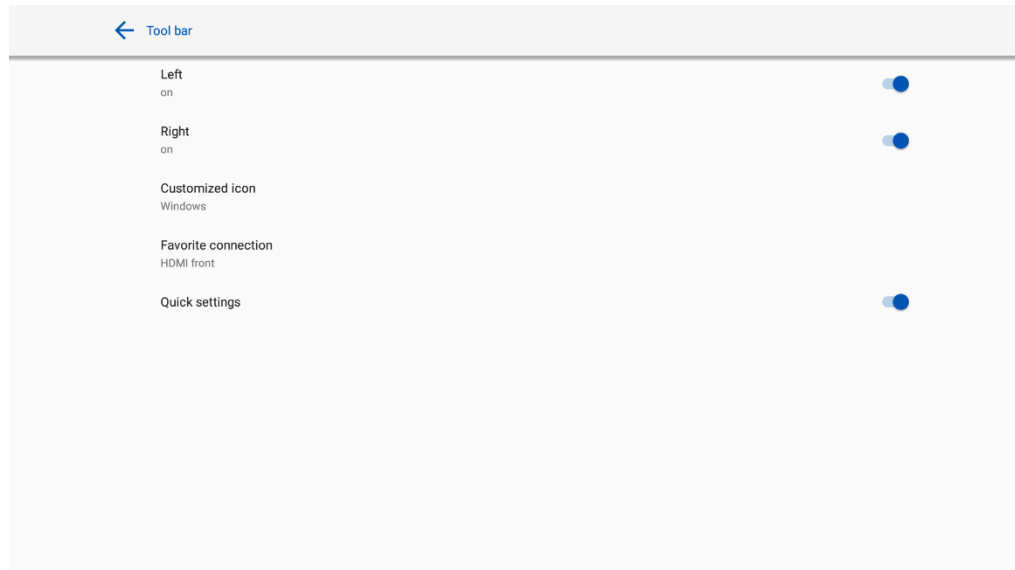

4.3.10 Input/Output Settings

Enter the **Input and output** setting submenu to set the starting source, new input source, and resolution of image output through the HDMI port etc..

- **New input source:** After the **New input source** function is enabled, the system can automatically switch to the screen of the newly connected signal source.
- **CEC auto power on:**
When this function is enabled: When the HDMI port of the machine is connected to a CEC device (such as a DVD), and both the CEC device and the machine are turned off, if the CEC device is turned on, the machine automatically turns on after receiving command from the CEC.
- **CEC auto power off:**
When this function is enabled: When the HDMI port of the machine is connected to a CEC device, and both the CEC device and the machine are turned on, if the machine is turned off, the CEC device automatically turns off after receiving the command; if the CEC device is turned off, the machine automatically turns off after receiving the command.
- **Starting source:** Set the signal source entered after power on.
- **Choose HDMI rear 1/2, DP EDID:** Set the EDID version (1.4/2.0) for HDMI rear 1/2, DP port.

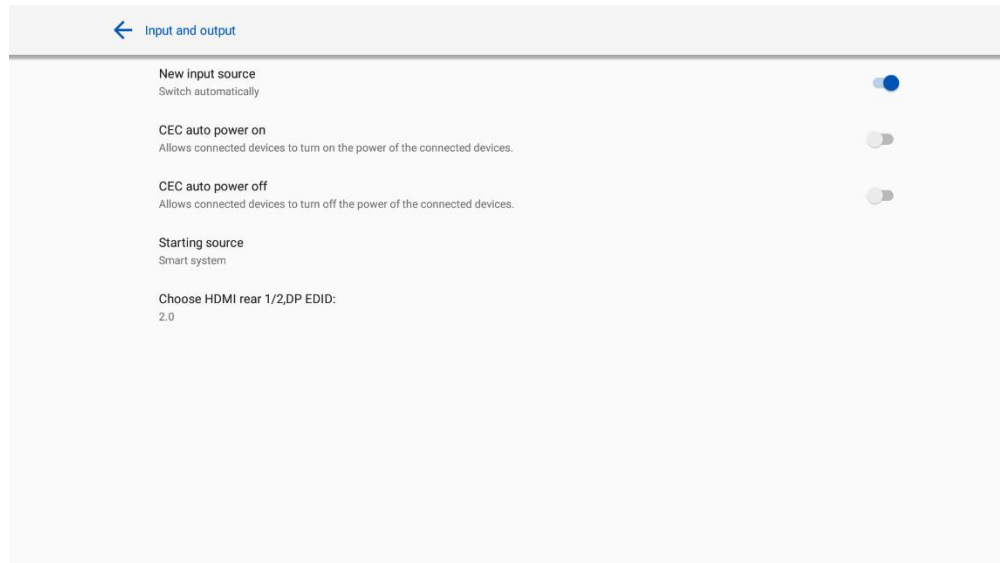

4.3.11 Display & Theme Settings

Enter the **Display & Theme** setting submenu to set the system theme, wallpaper, Home logo and lock screen logo.

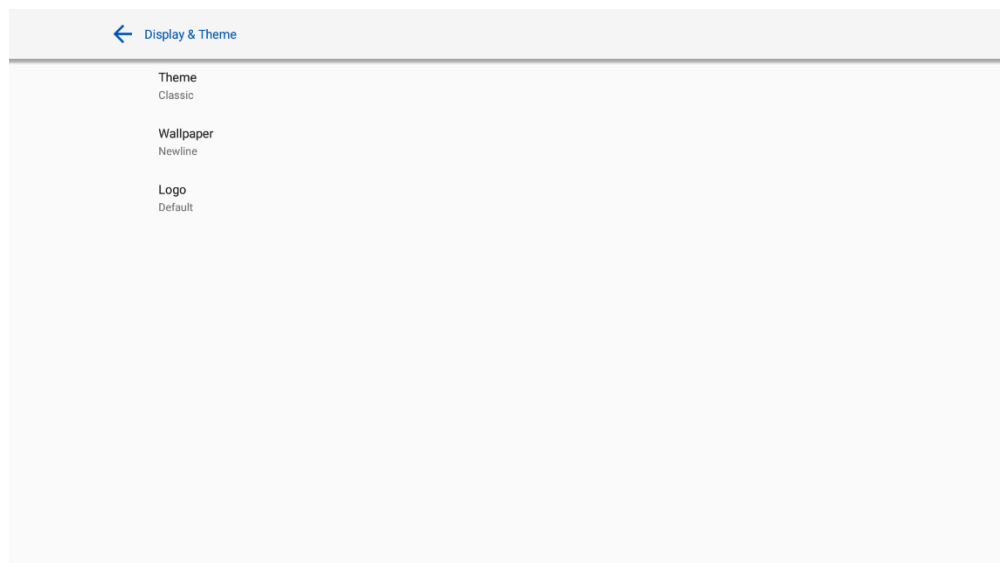

4.3.12 Security Settings

Enter the **Security** setting submenu to set Passkey lock, Whiteboard/Screenshot data clearance, Encryption & credentials, USB lock functions.

Passkey lock: Click to set whether you need enter the password or modified password when going from the Start page to the Home page. The password must be at least 4 digit numbers. English letters are not allowed.

Whiteboard/Screenshot data clearance: Click to set the regular clearance of discussion data.

Encryption & credentials: Click to view the information about encryption & credentials.

USB lock: Click to turn on/off the USB lock function.



4.3.13 System

Enter the **System** submenu to upgrade the system, perform a factory data reset, network settings reset, app preferences reset, view firmware information, embedded operating system version information or the display's serial number.

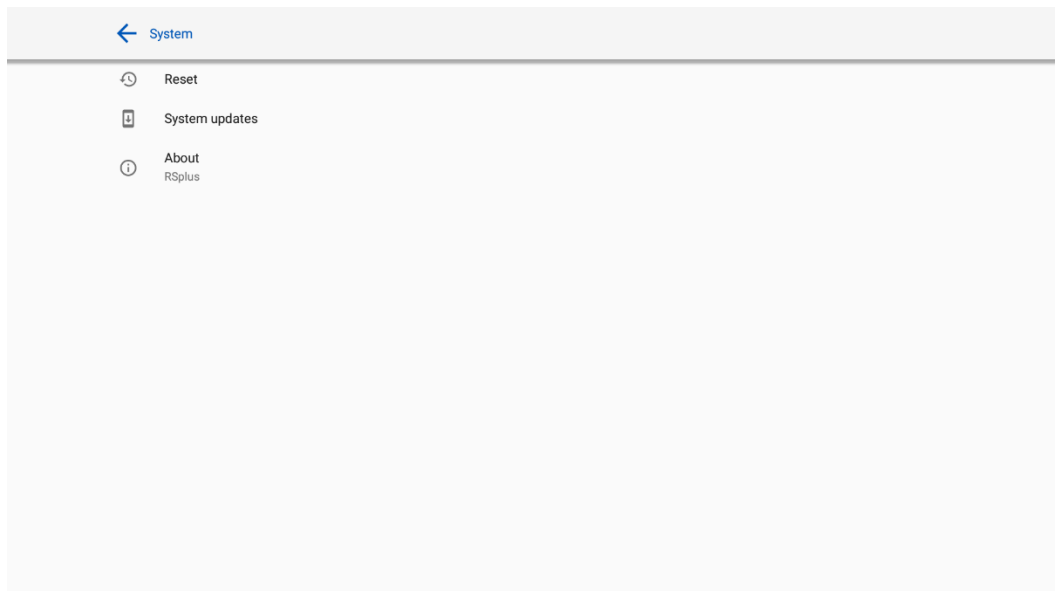

4.4 Windows

On the Home Page, click Windows to enter the Internal PC source, as shown in the following figure. If the display is not equipped with an Internal PC, "No Signal" is displayed.



4.5 Screen Sharing

Multiple devices can be cast wirelessly to the display through several casting modes (Airplay, Google Cast...). To cast: click Screen Sharing on the Home Page to enter Newline Cast. On screen directions will appear for you to follow in order to wirelessly cast to the display, as shown in the following figure:

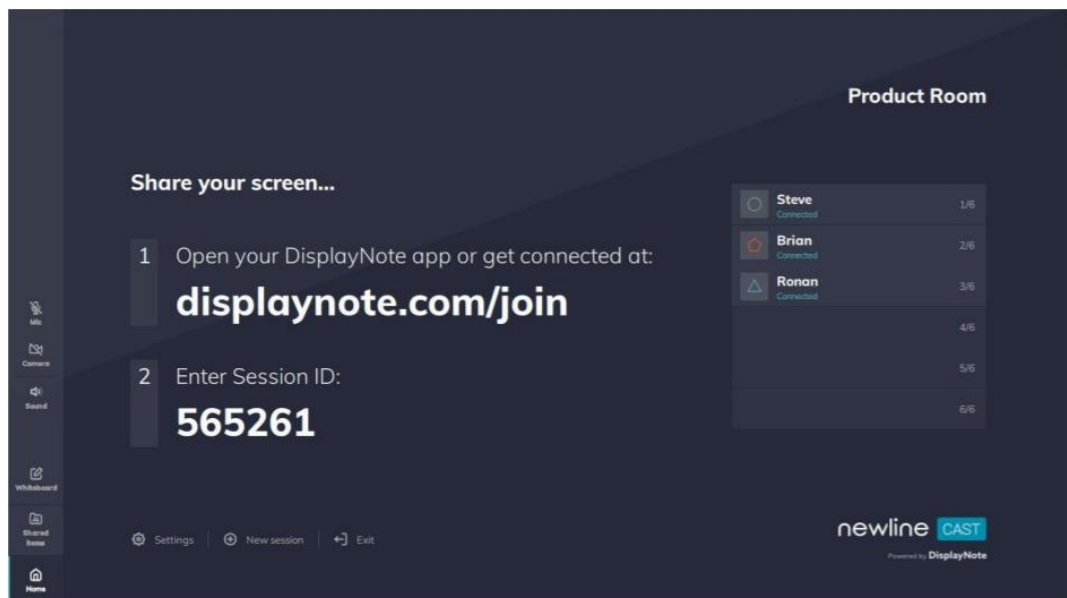

4.6 Whiteborad



The whiteboard has the following functions:

- **Discussion and screen annotation**
On the whiteboard page, you can select pen type, width, and color to write or annotate on the screen. You can also erase selected content or clear all content on the screen.
- **Page navigation**
Preview or delete pages.

Whiteboard Mode

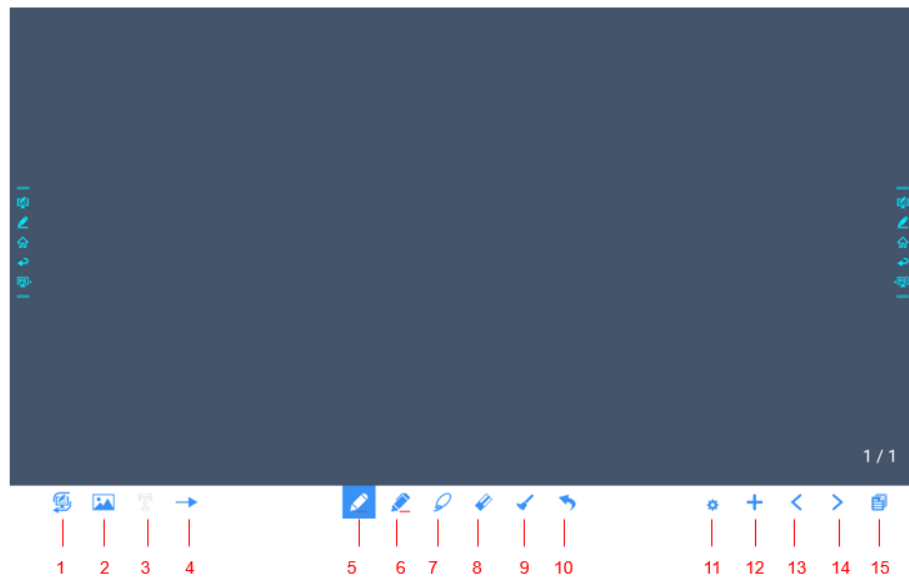
- Click **Discussion** in the main toolbar or click  on either side toolbar to enter the embedded whiteboard mode, as shown in the following figure:



- Click  on the side toolbar or click  in discussion mode to enter annotation mode. In annotation mode, a transparent layer lays over the screen, letting you write over whatever is on the screen until you exit annotation mode.

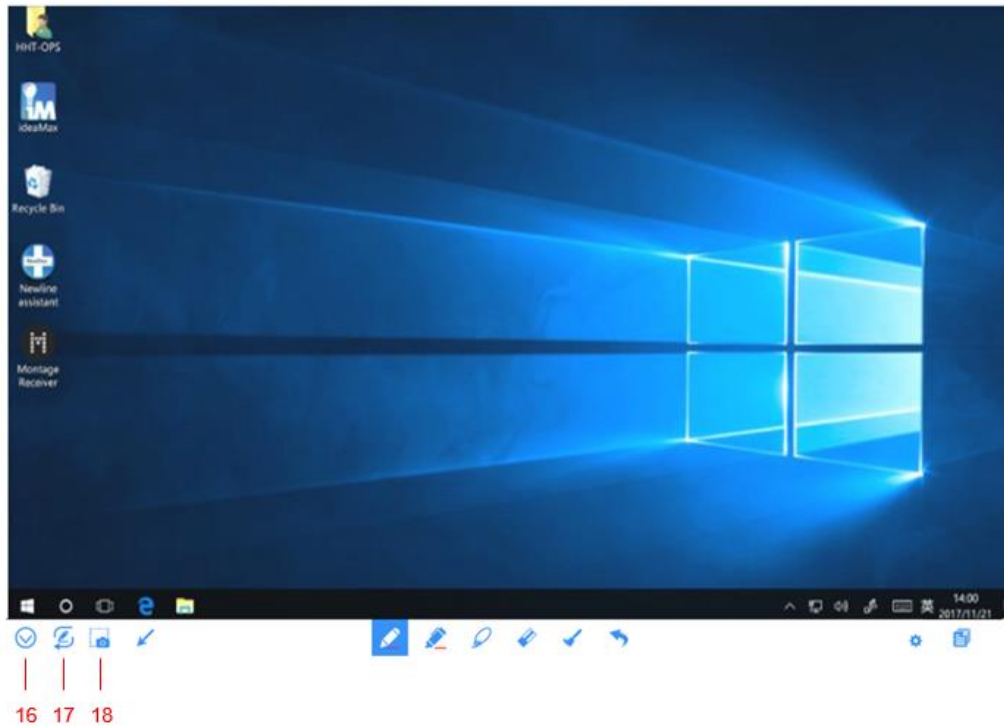

SN	Icon Name	Icon Function
1	Mode Switch	Click the icon to enter annotation mode. (See more detail in whiteboard mode section)
2	Import	Click the icon to insert picture.
3	Insert Text	Click and show the text window(Color/ Size) and the keyboard, then type in the text. Click and hold the icon for two seconds to set the default text setting.
4	Insert Auto Sharp	Click the icon to insert shape.
5	Pen	Click to use the pen function, and the icon turns into blue. Click and hold the icon for two seconds to set the size and color.
6	Highlighter	Click to use the highlighter function, and the icon will turn blue. Click and hold the icon for two seconds to set the highlighter size or color.
7	Select	Click it and user could choose the data on the page to move/ zoom in/ zoom out, and the icon turns into blue.
8	Eraser	Click to select the eraser function and the icon will turn blue. Click and hold the icon for two seconds to set the size of eraser.
9	Clear	Clear all data on this page.
10	Undo	Back to the previous step.

SN	Icon Name	Icon Function
11	Object recognition switch	Slide the turn on or off the object recognition function.
12	New Page	Click to add a new page. Click and hold for two seconds to set the color and the pattern of the new page.
13	Previous Page	Click to back to the previous page.
14	Next Page	Click to go to the next page.
15	Navigation	Click to show the page thumbnails.
16	Hide Smart Bar	Click to hide or show the smart bar.
17	Mode Switch	Click the icon to enter discussion mode.
18	Screenshot	Click to take a screenshot, and save the data in the display's internal storage.

4.6.1 Whiteboard Functions

New Page and Settings

- Create a new page

In discussion mode, click  to create a new page. Up to 20 pages can be created. See the following figure:

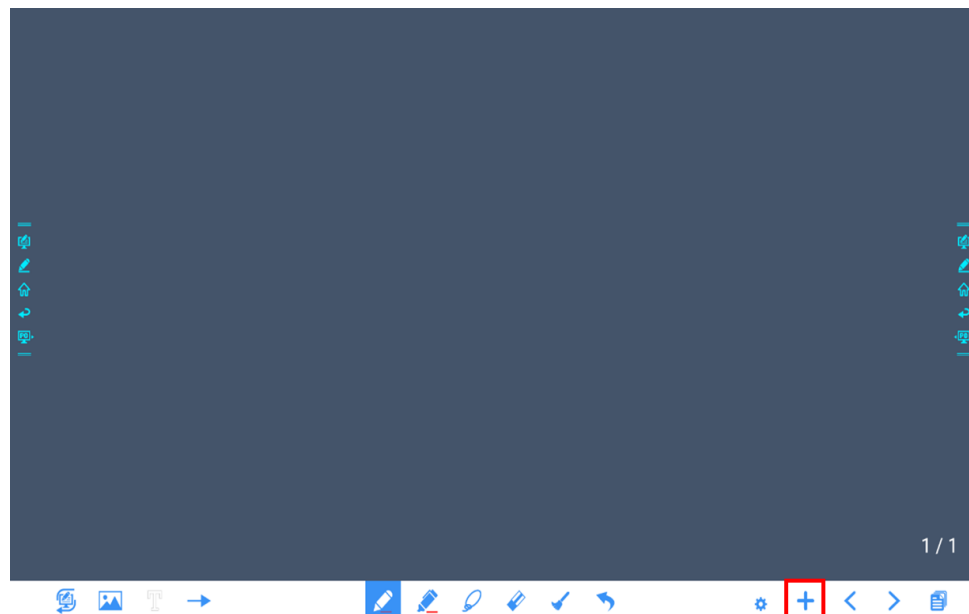

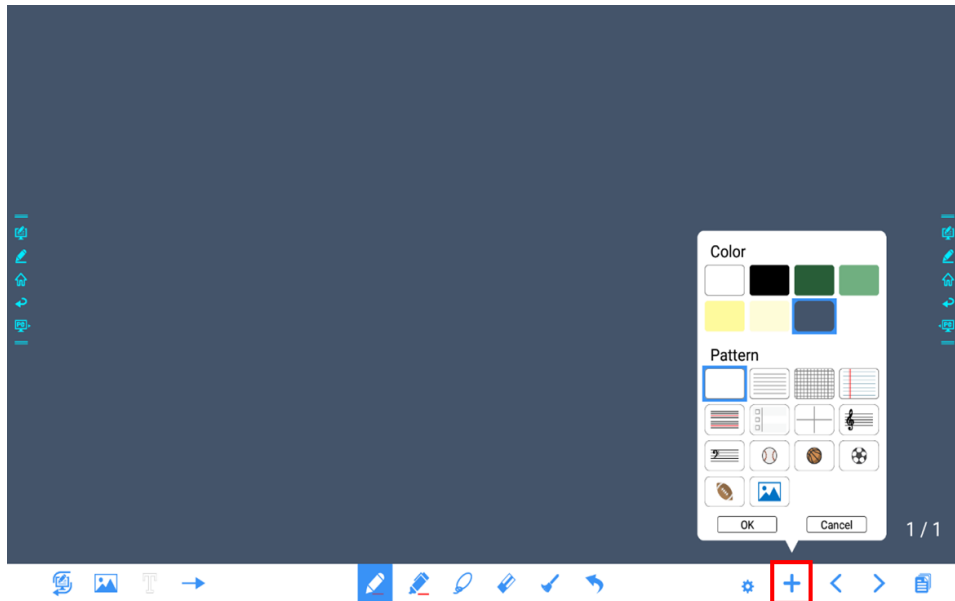

- Page settings

Click and hold **+** for two seconds to set the color and the pattern of the new page, as shown in the figure below.



Mode Switch

Click  and  in the lower left corner of the discussion mode to switch between whiteboard modes.

- Annotation mode
The background is transparent and the real-time image of the current signal source will be displayed. You can comment on presentation content such as Office documents and pictures as shown in the following figure:

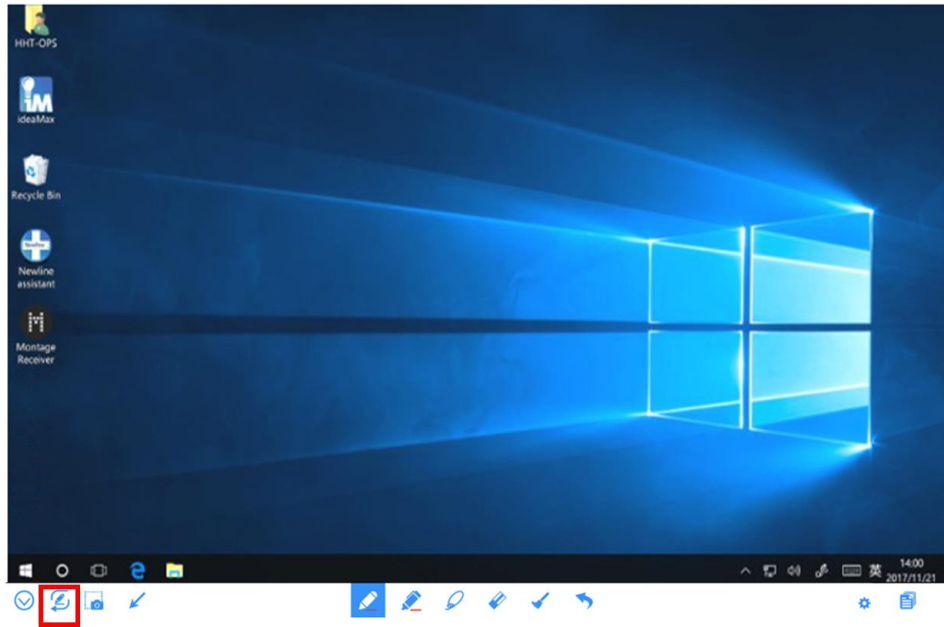

- Discussion mode
The background is a single color, as shown in the following figure. You can write content on the page as you wanted.

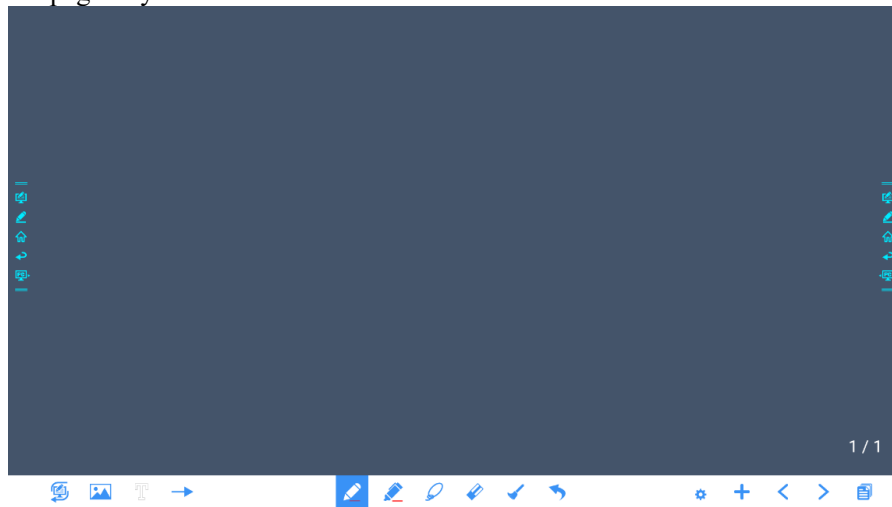

Import

On the Whiteboard, Click  to import data from file management, you can import the pictures/ whiteboard data (PNG)/ screenshots (PNG) from system files, USB, network.

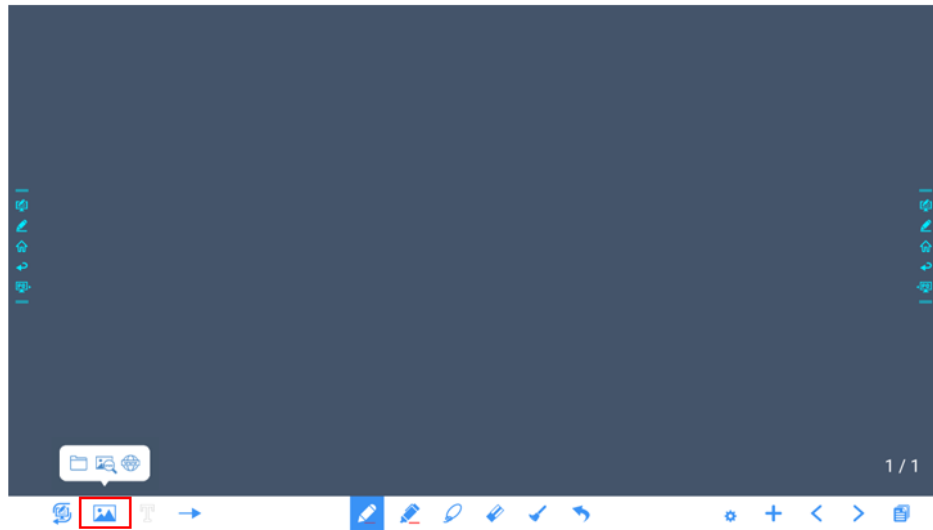

Insert Text

On the Whiteboard, Click  to insert text, and show the keyboard. Click and hold the icon for two seconds to set the default text setting.

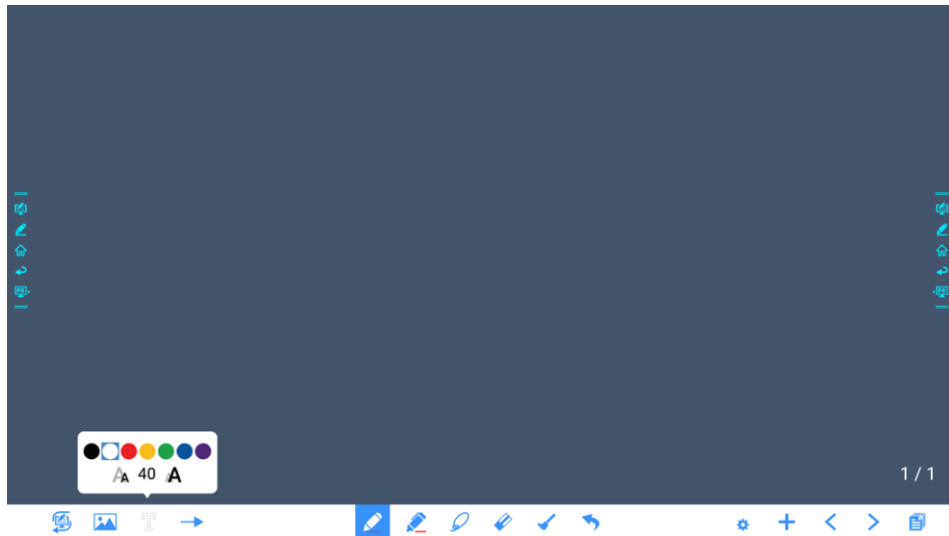

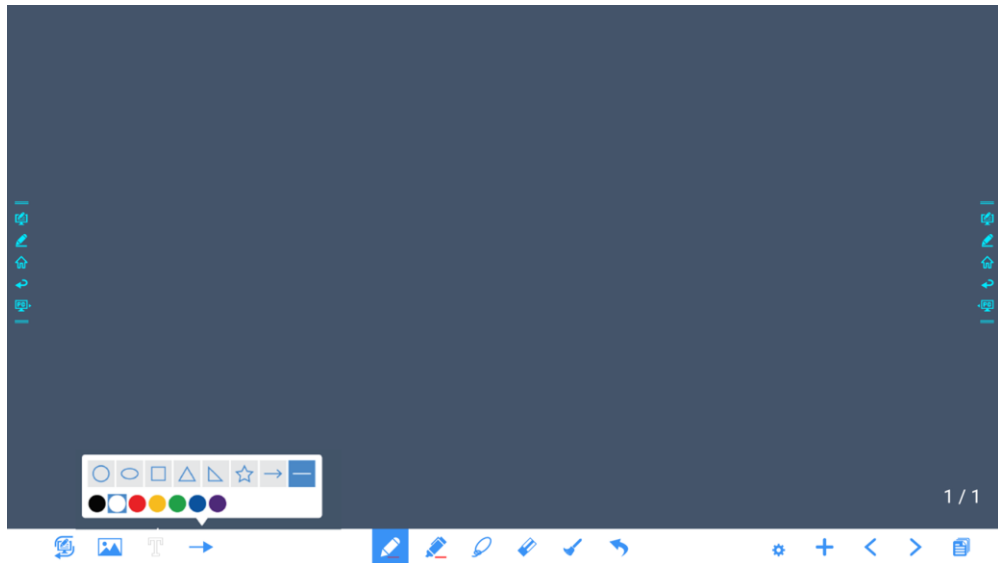

Insert Auto Shape

On the Whiteboard, Click  to insert the auto shape. Click and hold the icon for two seconds to set the shapes and color.





Pen Type

On the Whiteboard, two types of pens are supported: Pen and highlighter.

- Pen  : used to write.
- Highlighter  : used to highlight. Characters covered by comments are still visible.

Line Size and Color

On the Whiteboard, click and hold  or  for two seconds to set the size and color. You can select the line size and color for writing, as shown in the following figure:

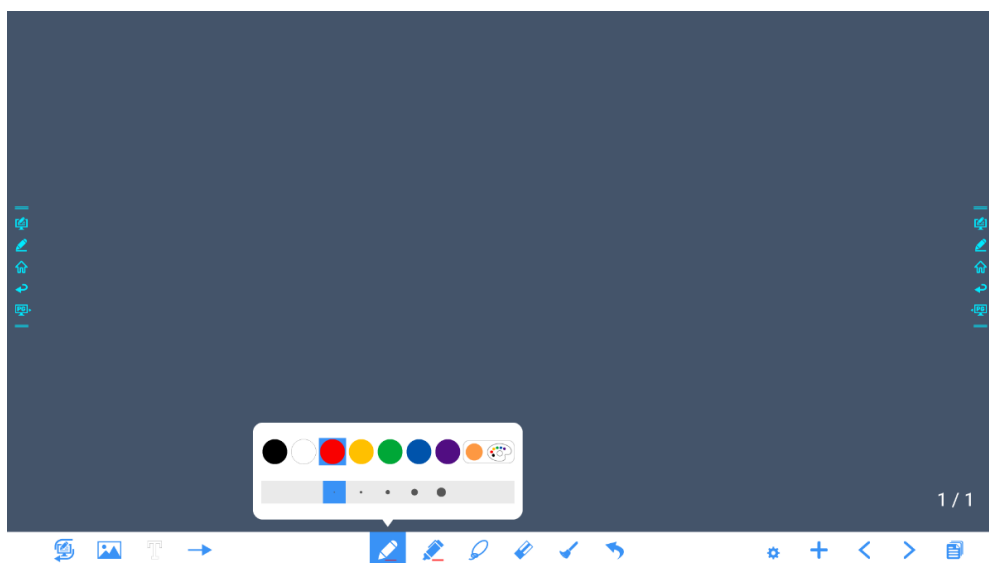



Select

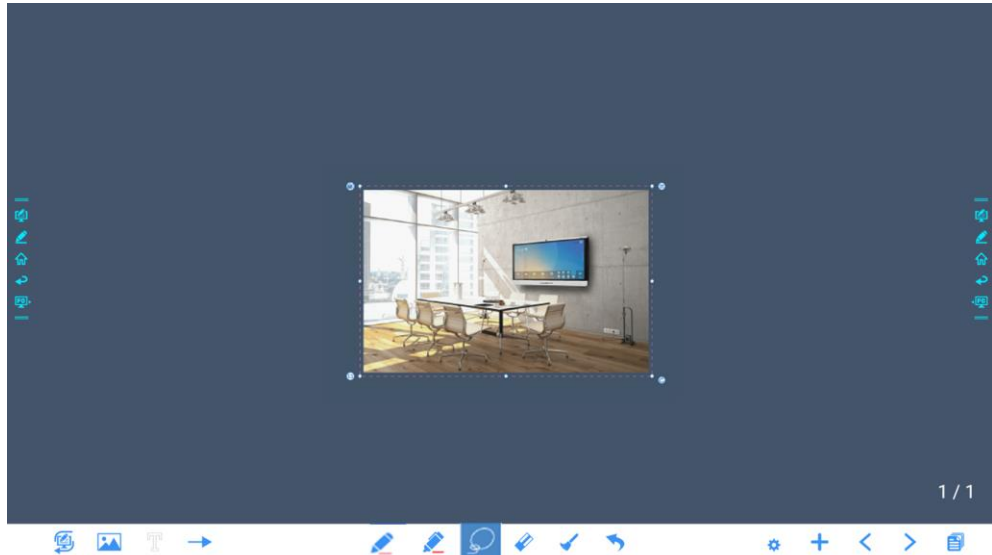



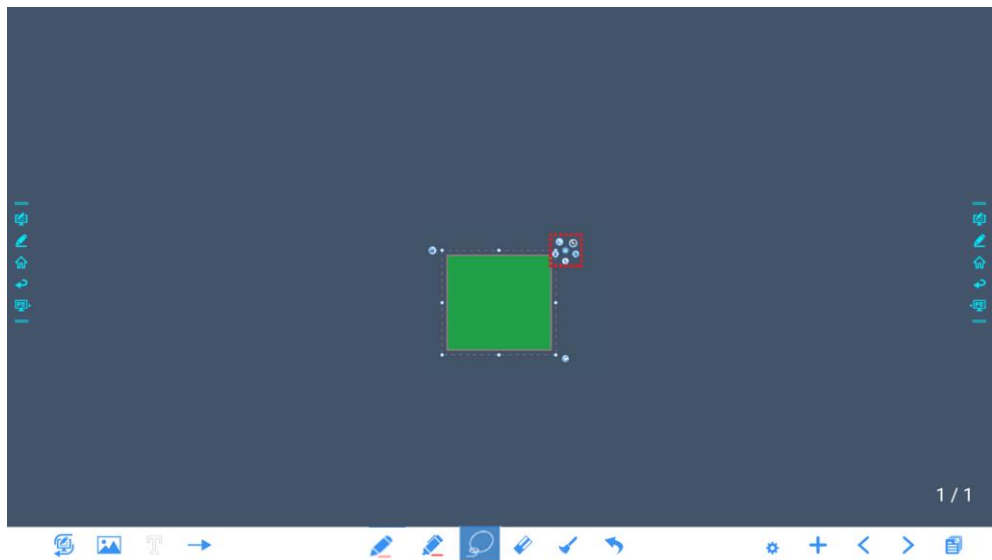

On the Whiteboard, Click  and user could choose the data on the page to move/ zoom in/ zoom out/ rotate by two fingers, and the icon turns into white.



Click  to expand the toolbar, users can copy or delete or cut the data or change the data color, such as the following figure:



Icon	Functions
	Click this icon to Crop the image.
	Long press this icon to Rotate the selected items

	Click this icon to Post the selected items.
	Click this icon to Change color for the selected items.
	Paste (long press the screen around two seconds and the icon will appear only after one item copied or cut)
	Click this icon to Push to bottom layer.
	Click this icon to Delete the items.
	Click this icon to cut the items.
	Click this icon to copy the items.

Eraser

Two methods are available to erase written errors or content as follows:

- Fist/hand back erasing: corresponding erase shape is a round with diameter 100pt.

- Spot erasing: Click  to clear errors or unnecessary content.



Clear All

On the Whiteboard page, click  to show the pop-up windows to clear all content on the current page, as shown in the following figure:

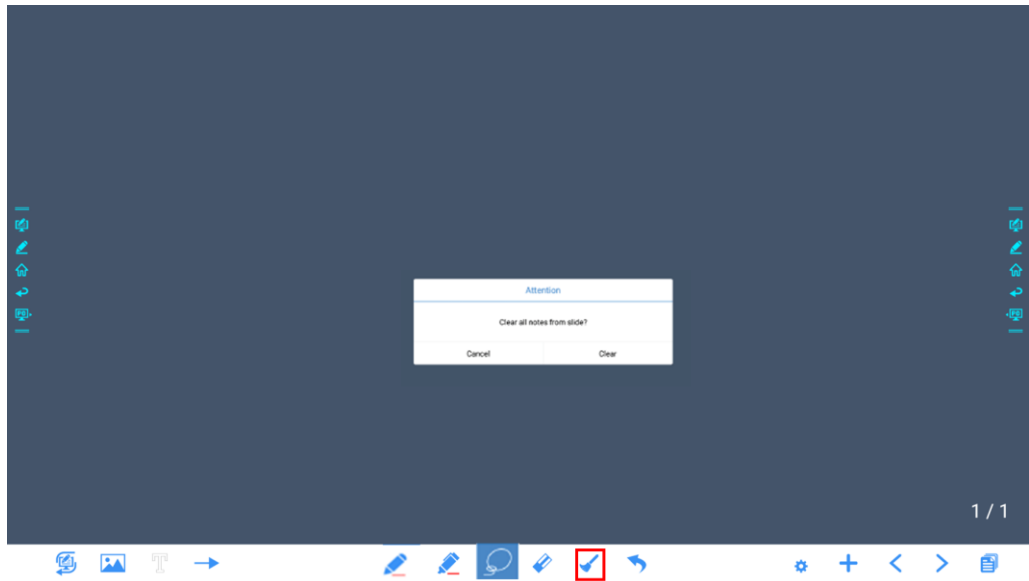

Object recognition switch

Press the setting  icon, it will pop up a switch and let user to change the object recognition setting, slide to left to open the object recognition function, slide to right to turn it off.



Screenshot

In annotation mode, click  to save the current slide as a picture. Up to 50 screenshots can be created. as shown in following figure:

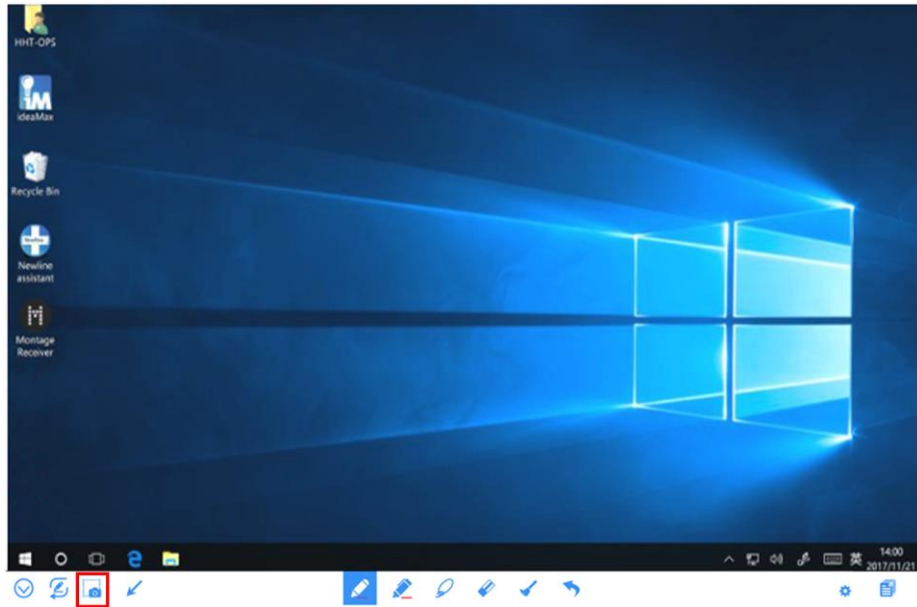

Pictures saved through screenshots can be viewed and obtained using the following methods:

- Screenshots are saved on the **Navigation** page, as shown in the following figure:

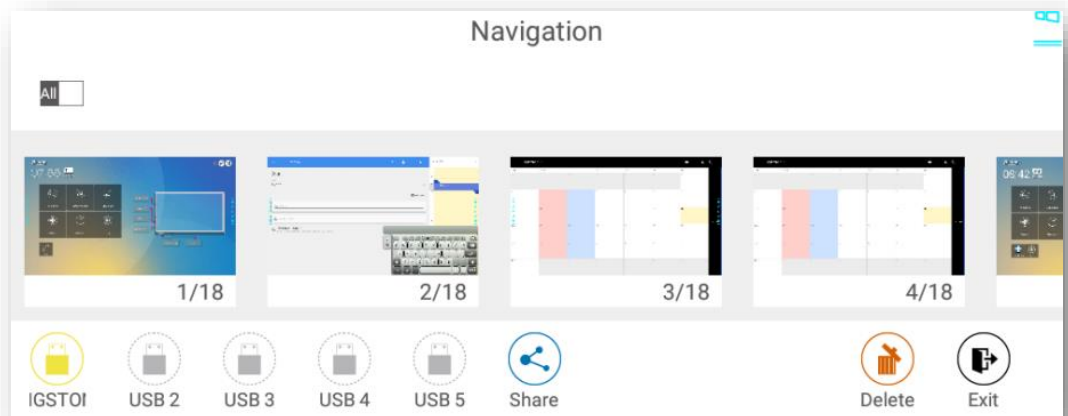

- Click  on the home page and choose **Internal storage > Pictures > Screenshots > image** to view or share screenshots.

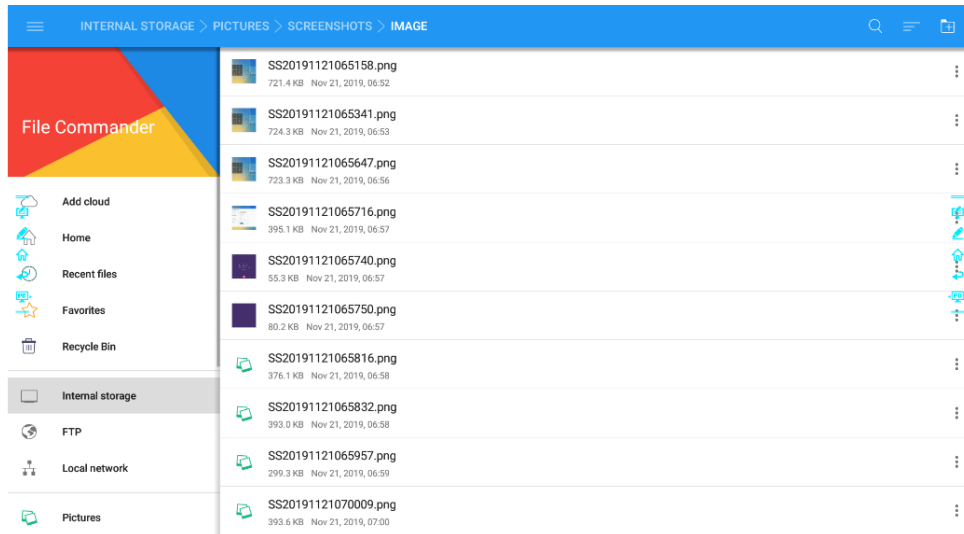

4.6.2 Page Management

You can preview, select, share, save, and delete any created writing page.

Page Preview

Click  on the lower right corner in the discussion mode. All pages will be displayed. Click one page to switch to that page for more operations, as shown in the following figure:



NOTE

Only 8 pages are displayed at once. You can slide right or left using one finger to see more.

Page Select Or Delete Page

On the **Navigation** page, you can select or delete writing pages according to requirements, as shown in the following figure.

- Click  to select all pages.
- Click  to share selected pages.
- Click  to delete selected pages.
- Click  to exit **Navigation**.

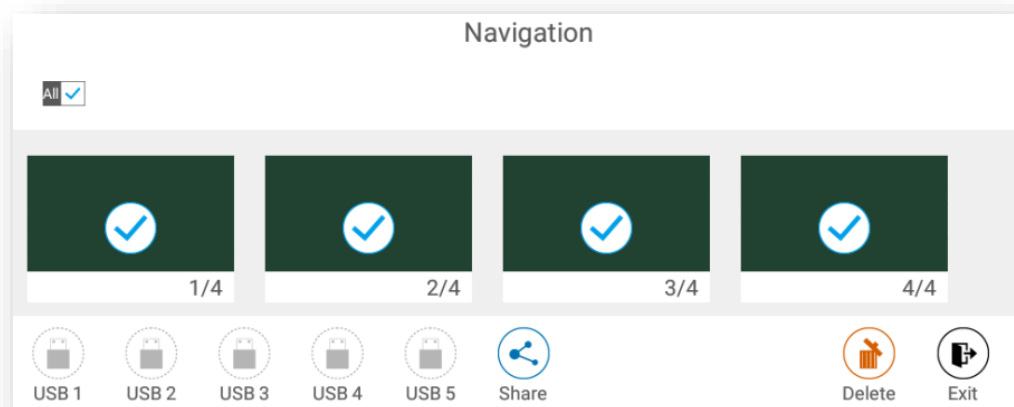

Save Page

On the Navigation page, when no external USB drives are connected, the USB icons will be gray. When an external USB drive is connected, the USB icons will turn yellow. Click the yellow USB icons and the selected whiteboard file can be saved in the folder of "Meeting + year month day hour minute second" under the root directory of the storage device.

NOTE

- Do not eject USB flash drive before completing the saving process.
- If the USB flash drive is larger than 16GB or the file format is not FAT32, the data will not be saved properly.
- If the screen is showing external source, USB port may be used by the source and USB drive may not appear in the list. In that case, please use the Android USB port on the back of the unit or change the source to the embedded operating system.

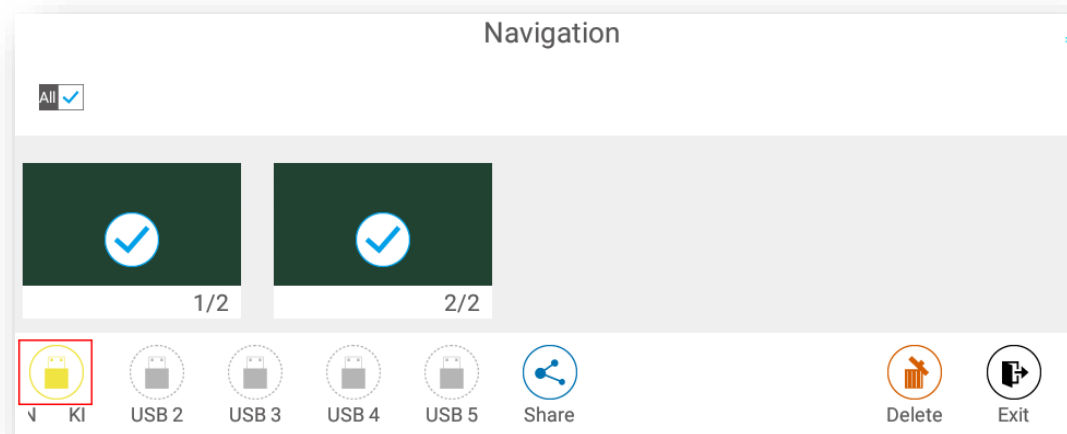

Page share

Click the  button on the Navigation page, click File Commander to save to local storage or to the cloud, or click AquaMail to share current the meeting files by email. Before sending by email, confirm that an email account is successfully set up in Settings.

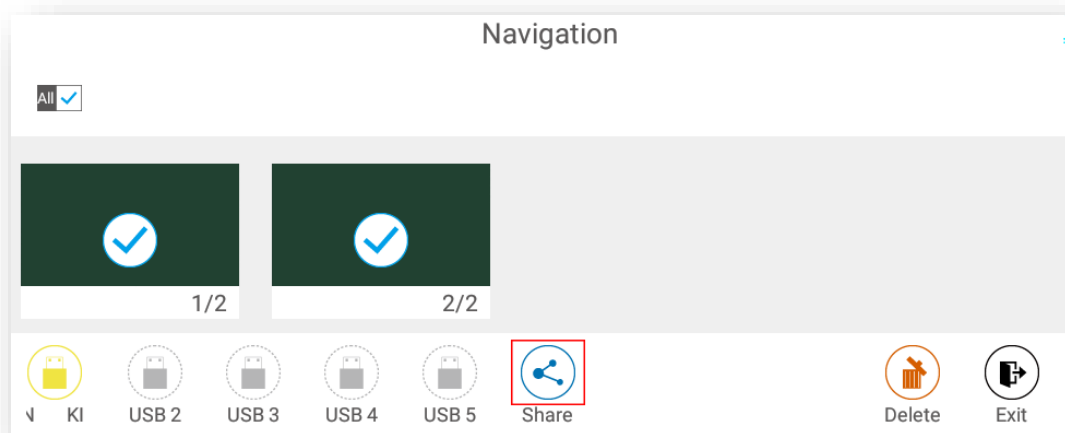

4.6.3 Object Detection

This product supports object recognition and produces different effects according to the diameter and size of the input objects.

- Fist/palm: identified as an eraser (100 pt).
- Fine Pen (3mm): suggested to use while writing.
- Thick Pen (≥ 8 mm)/ finger: suggested to use when you want to highlight.

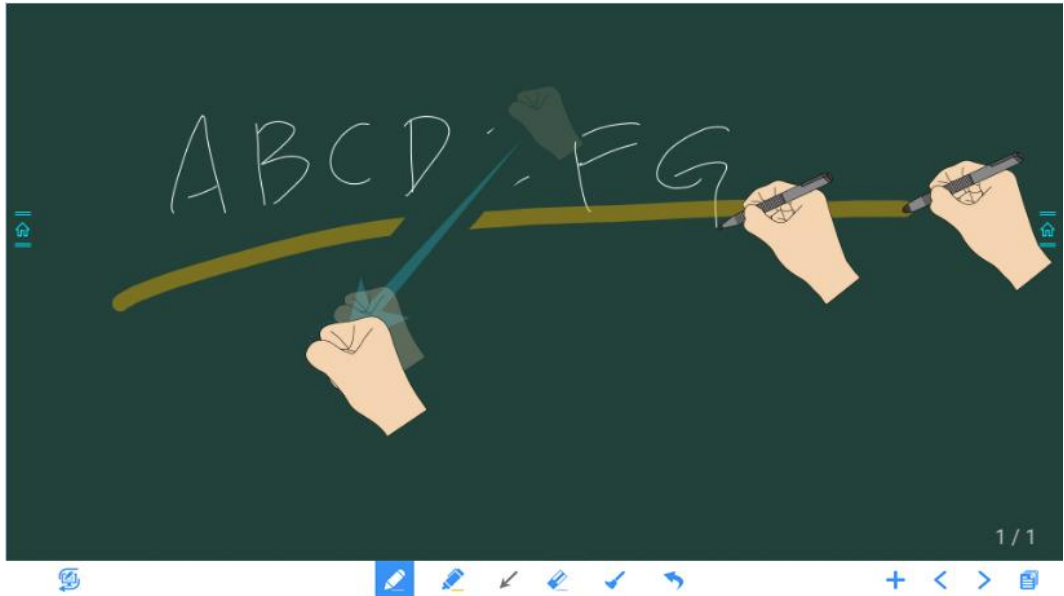

NOTE

If the diameter or size of the input object is larger than 3mm or smaller than 8mm, there is a risk of identification failure. Keep the object vertical while writing.

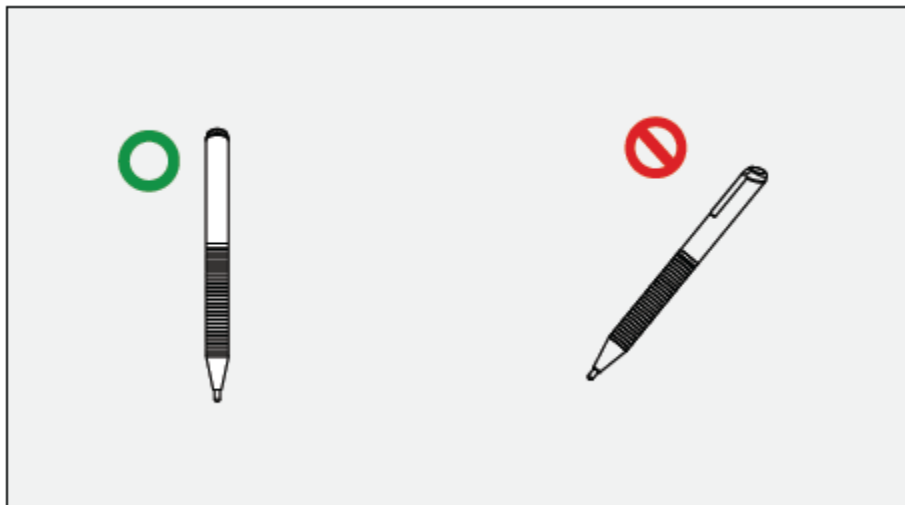

Object recognition: The system automatically remembers the settings selected for a fine pen and a thick pen. Users can use a fine pen (stylus or thick pen (finger) to utilize select functions (including pen color and thickness). After that, the system remembers this information until users change them manually.

- Fist/palm: keep the eraser (100 pt) function.
- Fine pen (3mm): before users manually change, the system remembers the previous selected attributes (including pen color and thickness).
- Thick pen (≥ 8 mm): before users manually change, the system remembers the previous selected attributes (including pen color and thickness).

4.7 Browser

On the **Home** page, click **Browser** to view web page, as shown in the following figure:



4.8 File Management

The product supports connection to USB flash memory. In File Viewer application, you can preview all files in the internal storage and storage devices connected via USB ports and select, copy, paste, delete and search for files.

4.8.1 File Viewer Page

On the **Home** page, click **File Viewer**, as shown in the following figure:



4.8.2 File Preview

Using the File Viewer application, you can click the submenu on the left side to preview what files are on internal storage, external storage devices connected via the USB ports, cloud stored files, FTP uploaded files, and local network files, as shown in the following figure.

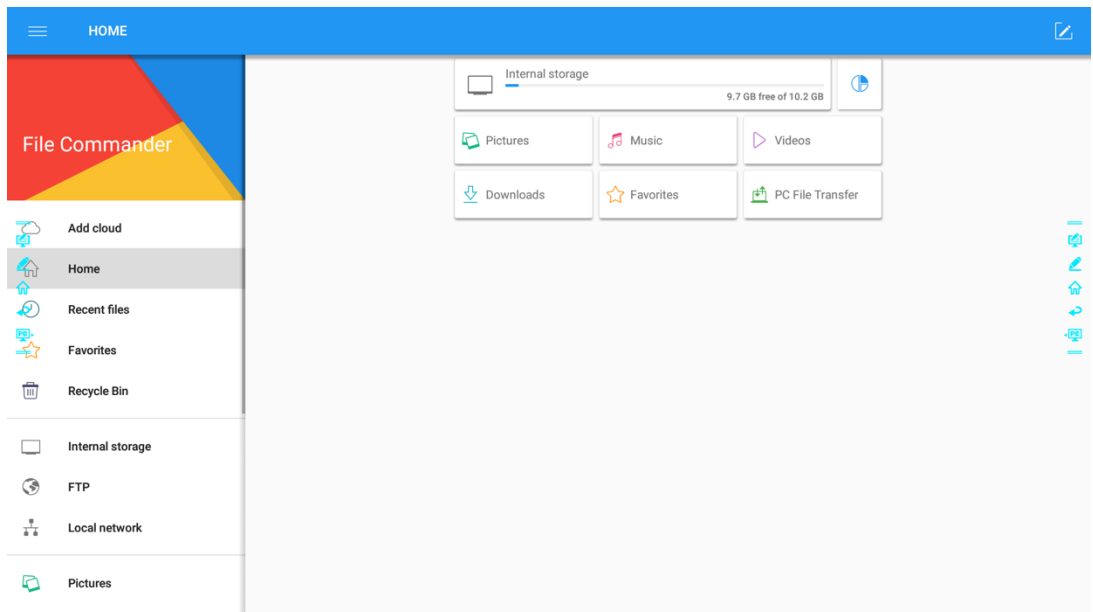



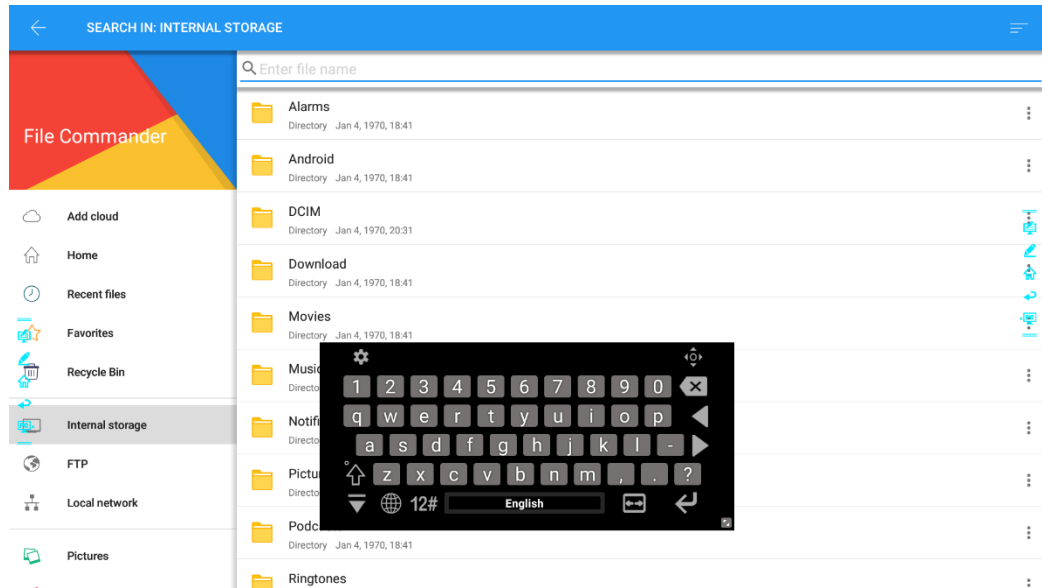

4.8.3 File Search

Enter the **File Viewer** application and click . In the dialog box that pops up, enter the keywords in the search box. The system will display a list of files that match the searched for keywords.



4.8.4 File Filtering

You can click the menu on the left side to display files by type, for example, whether the files is a document, a picture, music, a video, archived or was downloaded.

- The system supports two view modes: list and thumbnail. You can click  on the top right corner to switch  or  view modes
- Click  to display files based on name, type, size, and modification. You can also click  to filter files by whether they are pictures, music or video files.

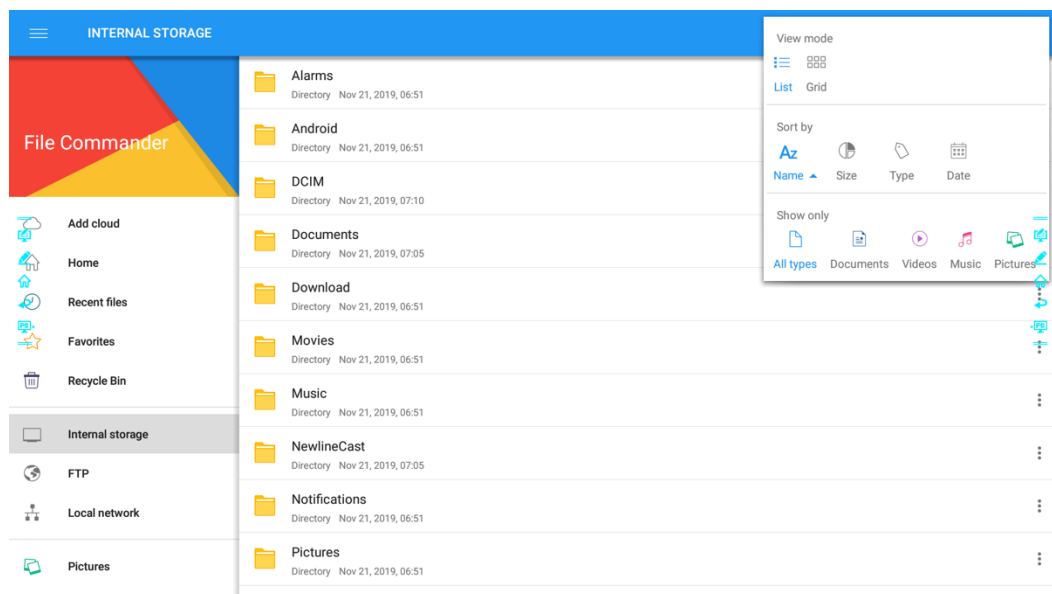

4.8.5 New Folder

Enter the **File Viewer** application, and click  to create folder. as shown in the following figure.

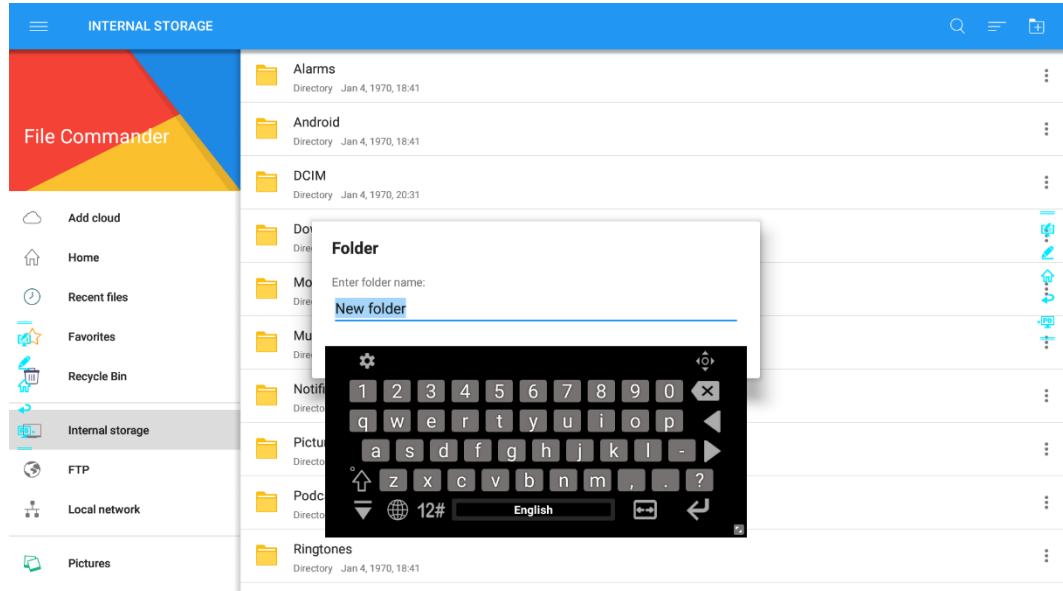

4.8.6 File Operation

Enter the File Viewer application. You can create folders according to requirements, select files by long pressing, and set wallpaper/copy/paste/delete. For details on other operation, click  in the upper right corner for more operation.

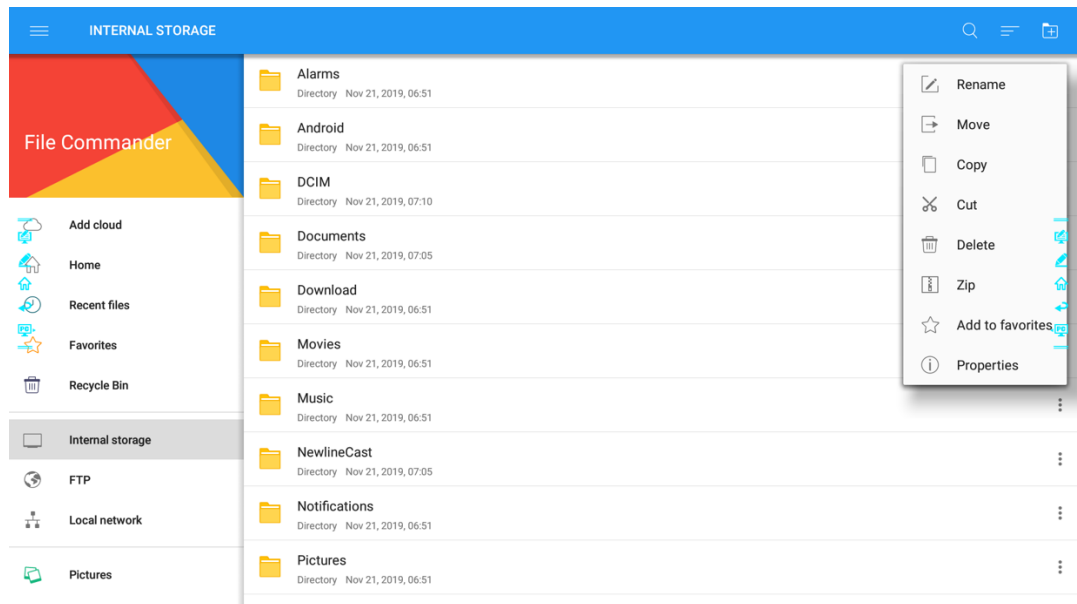

4.8.7 File Name

Under the "Internal storage > Pictures > Screenshots > image" folder in the File Manager, all pictures of this meeting are saved. Screenshots include annotation page screenshots, remote control

screenshots and pages in the discussion mode. Depending on the screenshots mode, picture naming is different. Picture files are named in the following of prefix + creation file.

Prefix name rule: WB (discussion mode page), AN (annotation page screenshot), and SS (remote control screenshot).

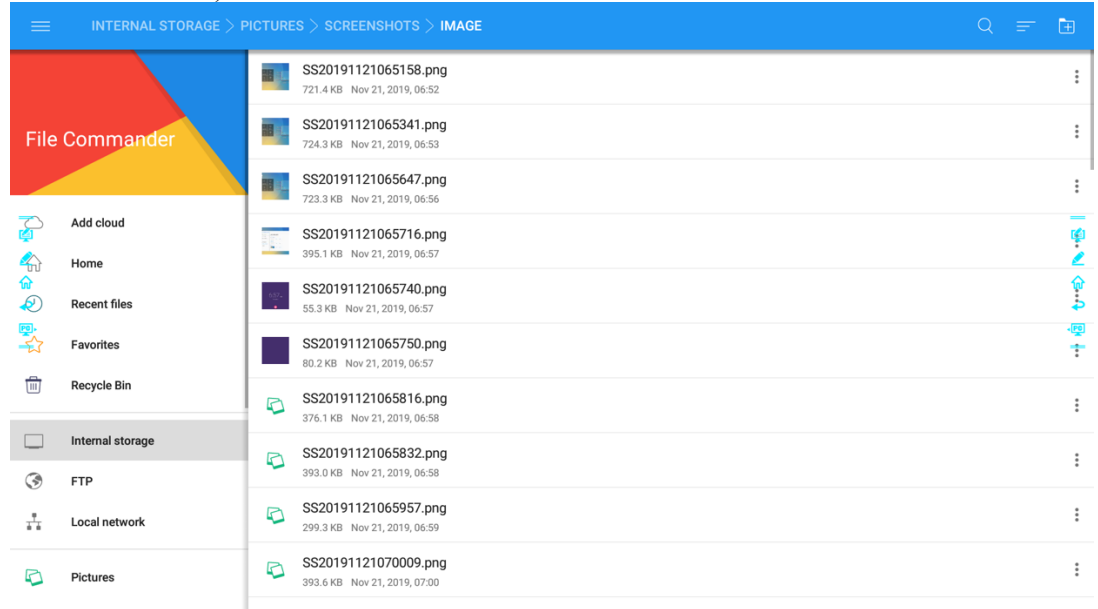





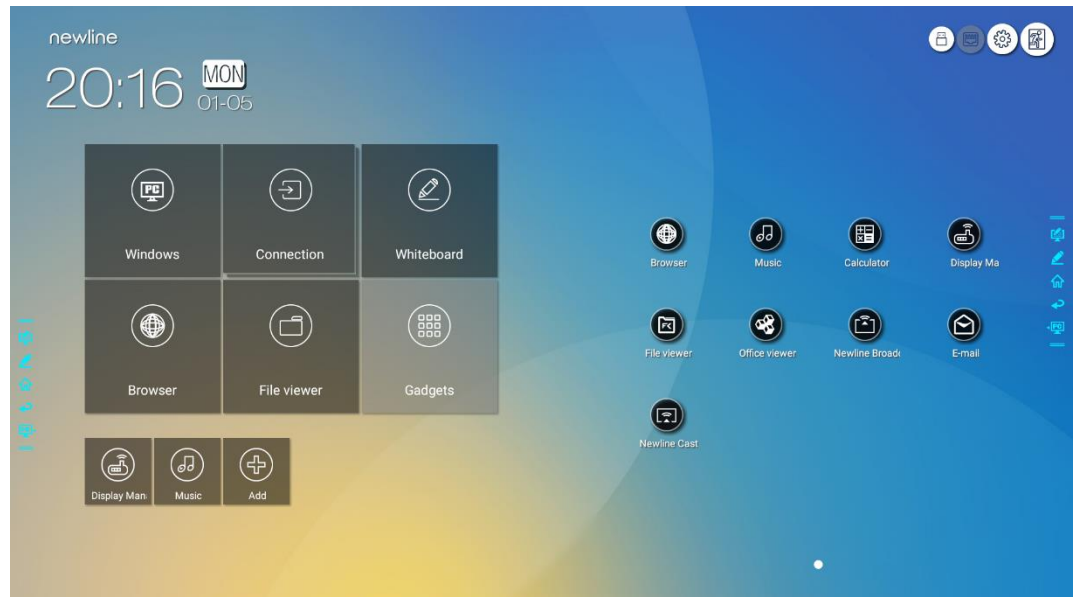



4.9 Gadget

On the Home page, click Gadget. On the page that is displayed, all applications can be viewed. The following figure shows applications that the system is delivered with.



Name	Icon	Functions
Browser		Click this icon to enter the browser application.

Name	Icon	Functions
Music		Click this icon to enter the music application.
Calendar		Click this icon to enter the calculator application.
Display management		Click this icon to enter the Display management application.
File viewer		Click this icon to open the File Manager and you can explore all internal and external files on the screen.
Office viewer		Click this icon to enter the Office viewer application. In this application, you can view office files, including excel, word, power point, and PDF files.
Newline Broadcast		Click this icon to enter the Newline Broadcast application.
E-mail		Click this icon to enter the email application and send files. Before sending files, you need to add an email account.
Newline Cast		Click this icon to enter the Newline Cast application.



4.10 Add Shortcut

4.10.1 Add Shortcuts to Home Page

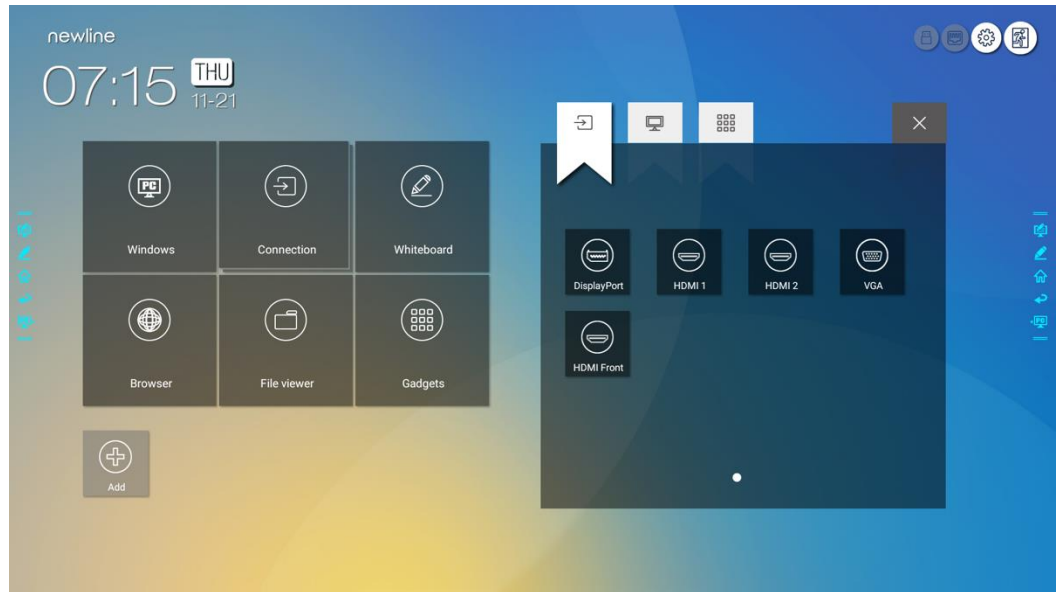
Step 1 On **Home** page, click the  icon in the lower right corner. The interface for adding shortcuts will be displayed.



Step 2 Click the icons on top to switch the list between external signal sources, Windows software shortcuts and pre-installed gadgets.

- Click  to view signal sources in **Connection**.
- Click  to view the Windows software shortcuts that the Newline Assistant uploads to the embedded operating system. For details, see “Add Quick Start Windows Programs in Smart System”.

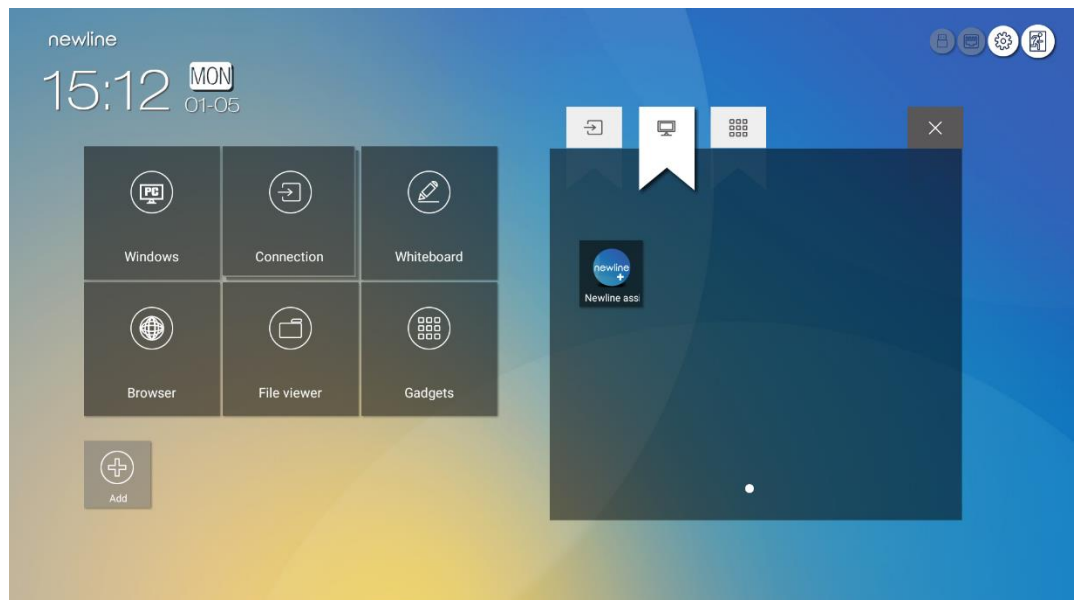

- Click  to view all Gadget applications.

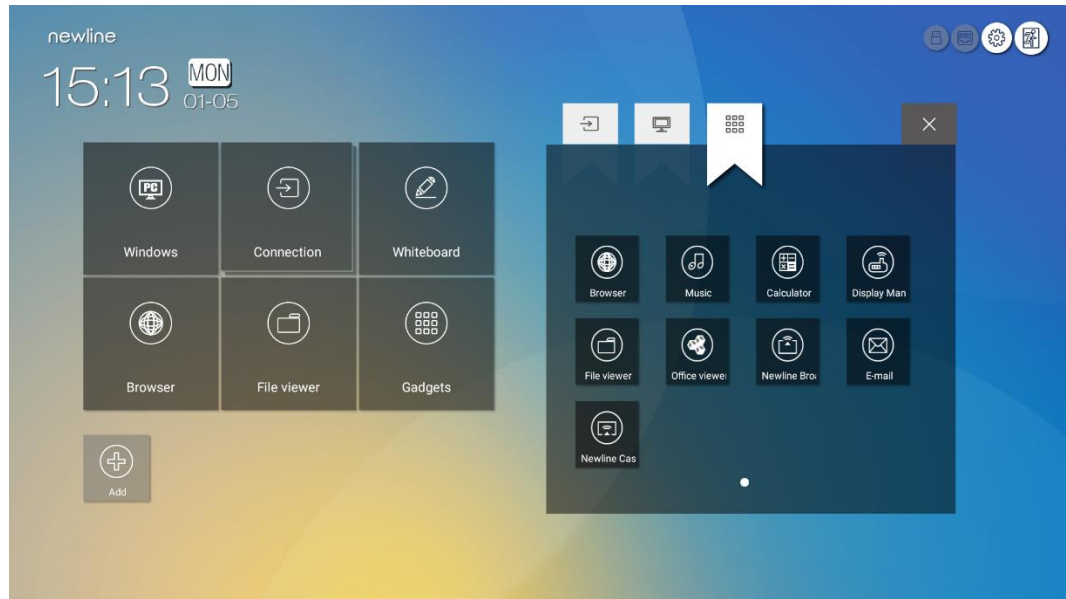

Step 3 Add or delete applications on the tab.

- In the list, click the icon to add it as a shortcut on the Home page. A check icon will appear at the upper right corner of the shortcut icons. Up to 5 shortcuts can be added.
- Tap the icon with the check mark again. The check icon will disappear and the shortcut will be removed from the **Home** page.

Step 4 At the **Home** page, click the shortcut icon and you can start the program/application or change to the external signal source.



4.10.2 Add Quick Start Windows Programs in Smart System

Step 1 In Windows, run the **Newline Assistant** program and drag the software icons or folder shortcut icons that you want to add from the desktop or menu to the **Newline Assistant** window. The applications added or deleted through the Windows system will be automatically updated to the embedded operating system until the upload progress reaches 100%. If there is an application not updated, click  in the upper right corner to manually update all icons in the Newline assistant window to the smart system.

 **TIP**

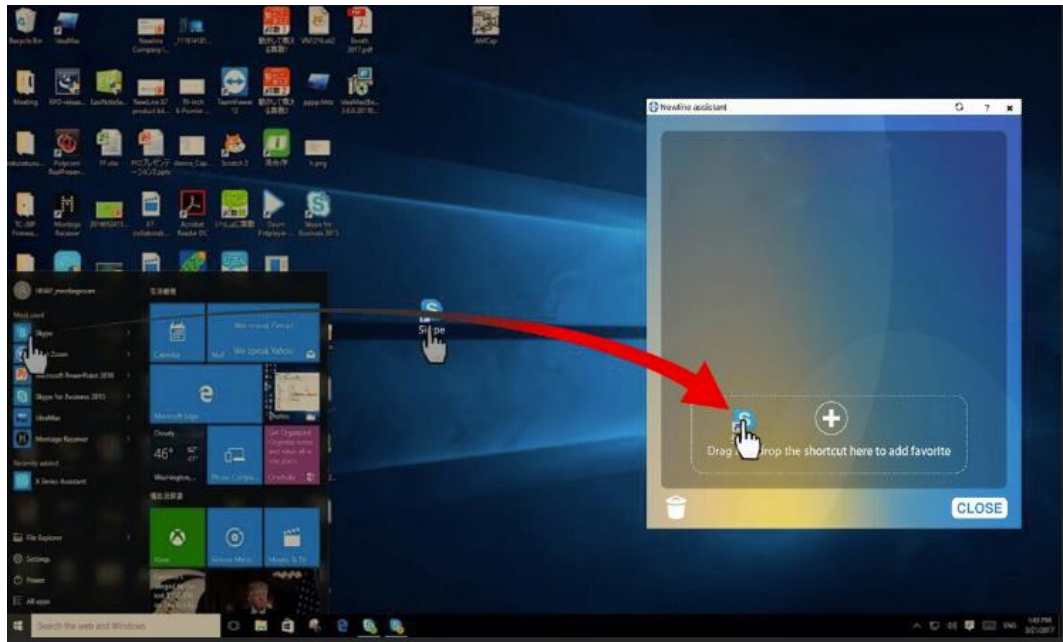
Only folders and .exe files are supported.



Step 2 Click  to return to the **Home** page. Click the  icon and go to the shortcut settings. The page for adding application programs will be displayed.



Step 3 At the shortcut setting page, click  icon to view all the Windows software shortcuts added by the Newline Assistant in Step 1.

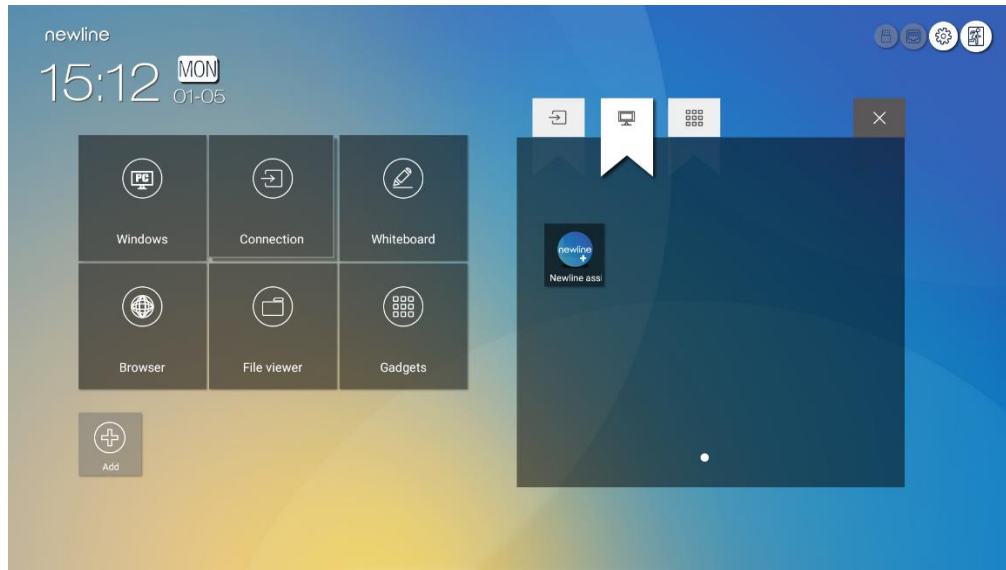

 **NOTE**

By default, the Newline Assistant application is added on the  tab.

Step 4 Tap the icon and add the shortcut at the Home page. Tap again and remove it.

Step 5 Return to **Home** page. Click the icon of an added Windows application to start the software.

4.11 Preview window

On the **Home** page, signal source preview window including internal PC, HDMI Front, HDMI Rear (1 to 2), Display Port, and VGA.

An icon without an active signal source connected will be gray, an icon with an active signal source connected will be white, and the icon of the signal source currently being previewed will be blue. After you choose a white icon, the content of the signal source can be displayed in the window for a real-time preview, the icon color will change from white to blue, and the name of the preview window for the signal source will change to match with the signal source being previewed.



4.12 Automatically Power Off











If the screen is left unoperated for a specified duration, it will be locked to guarantee your privacy. Choose Settings> Power ON/OFF Setting to set the duration. For details on the setting method, see "Power ON/OFF Setting".

After the screen is locked, if it is operated again within 120 seconds, the screen is unlocked. Otherwise, the screen enters the power off mode.

5 Quick Setting Menu

Using two fingers to swipe up from the bottom of the screen, the Quick Settings menu will appear, as shown in the following figure.



Icon	Functions
	Drag the slider to adjust the brightness.
	Drag the slider to adjust the volume.
	Click the icon to return to Home page.
	Click the icon to enter the settings page.
	Click the icon to turn on/off the Smart system Wi-Fi.
	Click the icon to mute/unmute.
	Click the icon to turn on/off the beep sound.
	Click the icon to enable sound only mode. In sound only mode, the screen LCD displays and LED backlight turns off, other functions are in normal operating condition.
	Click the icon to turn on/off the left toolbar.
	Click the icon to turn on/off the right toolbar.
	Click the icon to turn on/off the screen freeze function.

6 Serial Port Control



Connect RS-232 port to the PC or controlling product. Enable RS-232 serial port connection and complete the following configuration.

Port: COM1 (Set according to PC or controlling product's port number)			
Baud rate	19200	Odd/even check	None
Data bits	8	Stop bit	1





The following tables list controlling codes, querying codes and return codes.





Function	Controlling codes	Return codes
Power on	7F 08 99 A2 B3 C4 02 FF 01 00 CF	7F 09 99 A2 B3 C4 02 FF 01 00 01 CF
Power off	7F 08 99 A2 B3 C4 02 FF 01 01 CF	7F 09 99 A2 B3 C4 02 FF 01 01 01 CF
Mute/Unmute	7F 08 99 A2 B3 C4 02 FF 01 02 CF	7F 09 99 A2 B3 C4 02 FF 01 02 01 CF
Signal source	7F 08 99 A2 B3 C4 02 FF 01 06 CF	7F 09 99 A2 B3 C4 02 FF 01 06 01 CF
Enable whiteboard	7F 08 99 A2 B3 C4 02 FF 01 07 CF	7F 09 99 A2 B3 C4 02 FF 01 07 01 CF
Display status	7F 08 99 A2 B3 C4 02 FF 01 09 CF	7F 09 99 A2 B3 C4 02 FF 01 09 01 CF
HDMI front	7F 08 99 A2 B3 C4 02 FF 01 0A CF	7F 09 99 A2 B3 C4 02 FF 01 0A 01 CF
HDMI rear 1	7F 08 99 A2 B3 C4 02 FF 01 52 CF	7F 09 99 A2 B3 C4 02 FF 01 52 01 CF
HDMI rear 2	7F 08 99 A2 B3 C4 02 FF 01 53 CF	7F 09 99 A2 B3 C4 02 FF 01 53 01 CF

Function	Controlling codes	Return codes
VGA	7F 08 99 A2 B3 C4 02 FF 01 54 CF	7F 09 99 A2 B3 C4 02 FF 01 54 01 CF
Internal PC	7F 08 99 A2 B3 C4 02 FF 01 38 CF	7F 09 99 A2 B3 C4 02 FF 01 38 01 CF
DP	7F 08 99 A2 B3 C4 02 FF 01 56 CF	7F 09 99 A2 B3 C4 02 FF 01 56 01 CF
Page up	7F 08 99 A2 B3 C4 02 FF 01 13 CF	7F 09 99 A2 B3 C4 02 FF 01 13 01 CF
Page down	7F 08 99 A2 B3 C4 02 FF 01 14 CF	7F 09 99 A2 B3 C4 02 FF 01 14 01 CF
VOL -	7F 08 99 A2 B3 C4 02 FF 01 17 CF	7F 09 99 A2 B3 C4 02 FF 01 17 01 CF
VOL +	7F 08 99 A2 B3 C4 02 FF 01 18 CF	7F 09 99 A2 B3 C4 02 FF 01 18 01 CF
Menu	7F 08 99 A2 B3 C4 02 FF 01 1B CF	7F 09 99 A2 B3 C4 02 FF 01 1B 01 CF
Home page	7F 08 99 A2 B3 C4 02 FF 01 1C CF	7F 09 99 A2 B3 C4 02 FF 01 1C 01 CF
Return (exit)	7F 08 99 A2 B3 C4 02 FF 01 1D CF	7F 09 99 A2 B3 C4 02 FF 01 1D 01 CF
OK	7F 08 99 A2 B3 C4 02 FF 01 2B CF	7F 09 99 A2 B3 C4 02 FF 01 2B 01 CF
←	7F 08 99 A2 B3 C4 02 FF 01 2C CF	7F 09 99 A2 B3 C4 02 FF 01 2C 01 CF
→	7F 08 99 A2 B3 C4 02 FF 01 2D CF	7F 09 99 A2 B3 C4 02 FF 01 2D 01 CF
↑	7F 08 99 A2 B3 C4 02 FF 01 2E CF	7F 09 99 A2 B3 C4 02 FF 01 2E 01 CF
↓	7F 08 99 A2 B3 C4 02 FF 01 2F CF	7F 09 99 A2 B3 C4 02 FF 01 2F 01 CF
Set volume	7F 08 99 A2 B3 C4 02 FF 05 XX CF  NOTE XX indicates the volume value (0 to 100), corresponding to hexadecimals 00 to 64.	7F 09 99 A2 B3 C4 02 FF 05 XX 01 CF
Query the firmware version number	7F 08 99 A2 B3 C4 02 FF 01 3D CF	7F 09 99 A2 B3 C4 02 FF 01 3D 01 CF

Function	Controlling codes	Return codes
Set display mode	7F 08 99 A2 B3 C4 02 FF 06 XX CF  NOTE XX indicates the mode. 00 and 01 indicate standard and ECO modes respectively.	7F 09 99 A2 B3 C4 02 FF 06 XX 01 CF
Enable the comment function	7F 08 99 A2 B3 C4 02 FF 01 40 CF	7F 09 99 A2 B3 C4 02 FF 01 40 01 CF
Increase backlight brightness	7F 08 99 A2 B3 C4 02 FF 01 47 CF	7F 09 99 A2 B3 C4 02 FF 01 47 01 CF
Decrease backlight brightness	7F 08 99 A2 B3 C4 02 FF 01 48 CF	7F 09 99 A2 B3 C4 02 FF 01 48 01 CF
Set the value of backlight brightness	7F 08 99 A2 B3 C4 02 FF 09 XX CF  NOTE XX indicates the value of backlight brightness (0 - 100), corresponding to the hexadecimal number system (00 - 64).	7F 09 99 A2 B3 C4 02 FF 09 XX 01 CF
Switch backlight	7F 08 99 A2 B3 C4 02 FF 01 15 CF	7F 09 99 A2 B3 C4 02 FF 01 15 XX CF  NOTE <ul style="list-style-type: none"> • XX = 01 indicates the backlight is on. • XX = 00 indicates the backlight is off.
Switch to screen lock	7F 08 99 A2 B3 C4 02 FF 01 57 CF	7F 09 99 A2 B3 C4 02 FF 01 57 01 CF
Screenshot	7F 08 99 A2 B3 C4 02 FF 01 1F CF	7F 09 99 A2 B3 C4 02 FF 01 1F 01 CF
Settings	7F 08 99 A2 B3 C4 02 FF 01 20 CF	7F 09 99 A2 B3 C4 02 FF 01 20 01 CF

Function	Controlling codes	Return codes
Power supply	7F 08 99 A2 B3 C4 02 FF 01 37 CF	7F 09 99 A2 B3 C4 02 FF 01 37 XX CF  NOTE XX indicates the power on/off state. <ul style="list-style-type: none"> • XX = 01: power on state • XX = 00: power off state

Function	Querying codes	Return codes
Speaker	7F 08 99 A2 B3 C4 02 FF 01 82 CF	7F 08 99 A2 B3 C4 02 FF 01 82 XX CF  NOTE <ul style="list-style-type: none"> • 01: mute • 00: non-mute
Current signal source	7F 08 99 A2 B3 C4 02 FF 01 50 CF	7F 09 99 A2 B3 C4 02 FF 01 50 XX CF  NOTE <ul style="list-style-type: none"> • Smart system = 30 • PC = 17 • DP = 20 • HDMI rear 1 = 1F • HDMI Rear 2 = 1E • VGA = 00 • HDMI Front = 19
Speaker volume	7F 08 99 A2 B3 C4 02 FF 01 33 CF	7F 09 99 A2 B3 C4 02 FF 01 33 XX CF  NOTE <i>XX indicates current volume value (XX is a hexadecimal value, range: 00~64). For example, XX = 20 indicates current volume value is 32 (decimal value), XX = 00 indicates mute state.</i>
D.Mode	7F 08 99 A2 B3 C4 02 FF 01 35 CF	7F 09 99 A2 B3 C4 02 FF 01 35 XX CF  NOTE <i>XX indicates the mode.</i> <ul style="list-style-type: none"> 00- standard, 01- ECO mode, 02- Auto

Function	Querying codes	Return codes
Backlight brightness	7F 08 99 A2 B3 C4 02 FF 01 49 CF	7F 09 99 A2 B3 C4 02 FF 01 49 XX CF  NOTE XX indicates the value of backlight brightness (0 - 100), corresponding to the hexadecimal number system (00 - 64).
Backlight status	7F 08 99 A2 B3 C4 02 FF 01 81 CF	7F 08 99 A2 B3 C4 02 FF 01 81 XX CF  NOTE <ul style="list-style-type: none"> • XX = 00 indicates the backlight is on. • XX = 01 indicates the backlight is off.
Screen lock status	7F 08 99 A2 B3 C4 02 FF 01 84 CF	7F 08 99 A2 B3 C4 02 FF 01 84 XX CF  NOTE <ul style="list-style-type: none"> • XX = 01 indicates screen lock status . • XX = 00 indicates exit screen lock status.
Whiteboard state	7F 08 99 A2 B3 C4 02 FF 01 83 CF	7F 08 99 A2 B3 C4 02 FF 01 83 XX CF  NOTE <ul style="list-style-type: none"> • XX = 01 indicates the whiteboard state. • XX = 00 indicates non-whiteboard state.
Return to system state of the previous options	7F 08 99 A2 B3 C4 02 FF 0A 00 CF	7F 08 99 A2 B3 C4 02 FF 0A 00 AB CD EF GH IJ KL MN OP QR ST UV CF  NOTE <ul style="list-style-type: none"> • AB: Power supply • CD: Speaker • EF: Current signal source • GH: Speaker volume • IJ: D.Mode • OP: Backlight brightness • QR: Backlight state • ST: Whiteboard state • UV: Screen lock state

7 FAQs & Troubleshooting

Symptom	Troubleshooting Methods
The screen cannot be powered on or the power indicator light is off.	Check whether the power supply is connected.
	Check whether the power supply plug is properly connected.
	Check whether the power outlet has electricity.
	Check whether the rocker switch is enabled.
	Press the reset switch and start the system again.
The remote control is not causing a response.	Replace the batteries.
	Check whether the polarity direction of the batteries is correct.
	Align the remote control with the IR receiver window. For details, see section "Remote Control".
The image is normal but there is no sound.	Increase volume on both the screen and the Windows system.
	Check whether the screen and the Windows system are muted.
	If an external computer is connected, check whether the connection cables are normal.
The system is automatically powered on/off when no operation is being performed.	Disable the automatic power-on/off function. For details, see section "Power ON/OFF Setting".
	Check whether the screen entered shut down mode due to no operation for an extended period of time.
	Check whether the input power supply is stable.
The colors of images are abnormal.	Check whether the HDMI cable is properly connected or has any quality issue.

Symptom	Troubleshooting Methods
The touch function is abnormal or the positioning is inaccurate.	Restart the screen.
	In the Windows system, recalibrate the screen. For details, see section "Calibration".
The touch function is unavailable when the external signal source channel is being used.	Switch between different external signal sources.
	Ensure that the USB touch cable is connected to the proper port. For details, see section "Ports".
	Remove and insert the USB touch cable again.
There is no sound when the HDMI in channel is used.	Remove and insert the HDMI cable again.
No image is displayed when the HDMI out channel is used.	Generally, this issue is caused by the compatibility of the external display product. Replace the external display product and test again.
	The HDMI cable is too long or has a poor quality. Replace the HDMI cable delivered with the product.
The touch function on the front panel is ineffective.	Touch the button using your full fingertip.
	Check whether the finger is wet or has other liquids on it.
	Restart the screen.
The USB flash drive cannot be identified.	Check whether the USB flash drive is inserted into the correct USB port. For details, see section "Ports."
The conference records cannot be saved on the USB flash drive, and the system prompts "The target storage product has no write permissions."	Format the USB flash drive to the FAT32 format.
The internal PC has no signal.	Check whether the internal PC is properly inserted in the slot.
	Check whether the internal PC is in shut down mode.
	Press the power button on the internal PC (for details, see the instructions of the internal PC), and manually start up the internal PC.
In the embedded operating system or Windows system, no wireless network can be found or the wireless network signal is weak.	Check whether the Wi-Fi antenna is properly installed on the embedded operating system. For details, see section "Ports".
	Check whether the Wi-Fi antenna is properly installed for the internal PC.

Symptom	Troubleshooting Methods
The keyboard is not correctly displayed.	Confirm that the hardware keyboard is enabled.
When you connect a handheld microphone to a port on the front panel, the distance from user to microphone should be no less than 1 meter, otherwise the sound may distort.	The front panel doesn't support handheld microphone, and needs to use the fixed microphone. To make sure of the sound quality, the distance from user to microphone should be no less than 1 meter.
When the touch screen connects to CEC facilities and powers down, touch screen will stay in shut down mode after power restart. CEC facilities can't recall the touch screen.	Please use the remote control to start and turn off the touch screen. Then you can use the CEC facilities to recall it.

8 Specifications

Model	TT-6519RS/TT-6518RS+	TT-7519RS/TT-7518RS+	TT-8619RS/TT-8618RS+
Display			
Backlight	LED		
Display Area	56.24 x 31.63 in 1432 x 807mm	64.97 in x 36.55 in 1652 x 930mm	74.69 in x 42.05 in 1893 x 1069mm
Active Screen Size	65 inch	75 inch	86 inch
Display Ratio	16:9		
Resolution	3840 x 2160 Pixel		
Display Colors	8 bit+FRC, 1.07 billion colors	8 bit+FRC, 1.07 billion colors	10 bit, 1.07 billion colors
Brightness	≥ 370 cd/m ²		
Contrast	4000:1	4000:1	1200:1
Response Time	≤ 8 ms		
Life Time	30000 h (Min.)		
Speaker			
Speaker Position	Forward		
Max. Power Output	2 x 15 W		
Microphone			
Type	3.5 mm interface		
Electrical			
Power Consumption	Maximum ≤ 250 W Standby Mode ≤ 0.5 W	Maximum ≤ 400 W Standby Mode ≤ 0.5 W	Maximum ≤ 450 W Standby Mode ≤ 0.5 W
Working Voltage	AC 100 V – 240 V, 50 Hz / 60 Hz		

Model	TT-6519RS/TT-6518RS+	TT-7519RS/TT-7518RS+	TT-8619RS/TT-8618RS+
Touch			
Touch Surface	Anti-glare tempered glass		
Transparency	88%		
Surface Hardness	7H		
HID support	YES		
Touch Points	10 Points in Smart system 20 Points in Windows		
Writing Tools	Eraser, Stylus or Finger		
Scan Speed	10ms	10 ms	10 ms
Positioning Accuracy	Center area 1.0 – 1.5 mm / Edge area 1.2 – 2.0 mm		
Communication Interface	USB-A		
Transportation/Storage			
Storage Temperature/ Humidity	-15°C~55°C/20~90%RH(Non coagulation)		
Working Temperature/ Humidity	0°C-40°C/20~80%RH(Non coagulation)		
Mounting (optional)	Wall-mounted/Floor Stand		
Outline Dimension	60.87 x 37.1 x 3.74 in 1546 x 944 x 96 mm	69.69 x 42.17 x 4.29 in 1770 x 1071 x 109 mm	79.49 x 47.72 x 4.29 in 2019 x 1212 x 109 mm
Packing Dimension	67.91 x 42.72 x 11.02 in 1670 x 1056 x 221 mm	75.59 x 46.85 x 10.83 in 1894 x 1193 x 247 mm	84.84 x 51.97 x 12.21 in 2170 x 1345 x 275mm
Net Weight	approx. 44kg	approx. 56kg	approx. 72kg
Gross Weight	57±2kg	71±2kg	90±2kg
Ports			
Front Interface Inputs	HDMI In x 1, USB (Touch) x 1, USB (Public) x 2, Microphone In x 1		
Rear Interface Inputs	HDMI In x 2, DP x 1, USB (Touch) x 4, HDMI Out x 1, Line Out x 1, DC Out (5V, 2A), SPDIF out x 1, USB 2.0 (Public) x 1, USB 2.0 (Embedded) x 1, RS-232 x 1, USB 3.0 (Public) x 1, Audio In x 1, VGA x 1, LAN In x 1, LAN Out x 1, OPS Slots (4K@60Hz)		

Model	TT-6519RS/TT-6518RS+	TT-7519RS/TT-7518RS+	TT-8619RS/TT-8618RS+
Other functions			
Intelligent thermos protector	Yes		
Smart System			
Chips	ARMv8 A73*2+A53*2 (A53 : 1.05-1.3GHz; A73 : 1.15-1.5GHz)		
RAM	3GBytes		
Flash	16GB build in + 32GB TF card		
Multimedia File Formats	Supports all major types of multi-media files		
Pre-installed applications	On Screen Annotation, Discussion Board, Gallery, Browser, Music, E-mail, File viewer, Keyboard, Office Viewer, Newline Cast, Newline Broadcast, Display Management		

9 More Information

For More Information

Please visit our website (www.newline-interactive.com) for detailed instruction manual.

Contact Us for Support

Please email us at support@newline-interactive.com.

Our company is devoted to product innovation and technology enhancement. Therefore, we may change product specification and information without notice. Product pictures in the manual are for reference only, please refer to actual products.