

Installation and Maintenance manual

LED Module

[Models for indoor use]

LED-FC009i

LED-FC012i

LED-FC015i

MODELS: LED-FC009i, LED-FC012i, LED-FC015i

Table of Contents

Important Information	English-1
Contents.....	English-5
Related Items for Installation	English-6
Parts Name	English-7
Installation Example	English-9
1. Installation location.....	9
2. Handle	10
3. Installation with brackets.....	11
4. Installation with a wall-mount frame	14
5. Wiring.....	30
6. Installing the pixel card	35
Screen Configuration	English-37
Image Setting	English-46
Cleaning	English-48
Maintenance.....	English-49
Troubleshooting	English-54
1. Display problems	54
2. State monitoring using the software.....	55
Specifications	English-60
Diagram	English-61



Important Information

Safety Precautions and Maintenance



FOR OPTIMUM PERFORMANCE, PLEASE NOTE
THE FOLLOWING WHEN SETTING UP AND
USING THE LED DISPLAY SYSTEM:

About the Symbols

To ensure safe and proper use of the product, this manual uses a number of symbols to prevent injury to you and others as well as damage to property. The symbols and their meanings are described below. Be sure to understand them thoroughly before reading this manual.















 WARNING	Failing to heed this symbol and handling the product incorrectly could result in accidents leading to major injury or death.
 CAUTION	Failing to heed this symbol and handling the product incorrectly could result in personal injury or damage to surrounding property.

Examples of symbols









	⚠ Indicates a warning or caution. This symbol indicates you should be careful of electric shocks.
	⊘ Indicates a prohibited action. This symbol indicates something that must be prohibited.
	● Indicates a mandatory action. This symbol indicates that the power cord should be unplugged from the power outlet.

- Be sure to read the following before using the product to use it correctly and safely.

WARNING

-  Do not apply vibrations or shocks to the product.
-  Do not install the product to unstable locations or locations subject to vibrations.
-  Always ask a technician to perform the installation.
-  Do not connect the cables with wet hands. Otherwise, it may cause an injury or an electrical shock.
-  Do not repair or modify the product yourself. Otherwise, it may cause an injury, a fire or an electrical shock.
-  In case of thunder, do not touch the power cord. Otherwise, it may cause an electrical shock.
-  Connect the product to the correct voltage. If the product is connected to a voltage other than the specified voltage, it may lead to a fire or an electrical shock.
-  In case of a malfunction (nothing is displayed on the screen, etc.) or if smoke, abnormal heat, or a strange sound or odor is generated, turn the power off and immediately ask a technician or your retailer for repair.
-  Install the product so that the vents are not obstructed.
-  Make sure there are enough people available to ensure safety (at least two people) when installing or moving the product. Otherwise, it may lead to an injury.
-  Be sure to ground the product. If the product is not grounded, there is a risk of electrical shock in case a malfunction occurs.
-  In case foreign matter has entered into the product, immediately disconnect the power supply and stop using the product.
-  After the installation, if a problem such as loose screws occurs, immediately ask a technician or your retailer for repair.
-  Do not put objects into the product. Otherwise, it may cause a fire or an electrical shock.
-  In case the product is in contact with water or another liquid, immediately disconnect the power supply and stop using the product. If you continue using the product in that state, it may lead to a malfunction, a fire, or an electrical shock.

CAUTION

-  When connecting the power cord to the product's AC IN terminal, make sure the connector is fully and firmly inserted.
-  Do not damage the power cord. Do not put heavy objects on it, place it near heaters, pull it with excessive strength, or apply a strong force on it while it is bent. A damaged power cord may cause a fire or an electrical shock.
-  Do not install the product in narrow places where heat tends to build up.
-  Do not use the product in an environment with low heat dissipation. Otherwise, it may cause a malfunction.
-  The RJ-45 port of the product is for use with the product only. Do not connect it to a network. Connecting this port to a network that may receive over-voltage current may cause damage to the product or an electrical shock.
-  Do not use the product in a vehicle or another means of transportation.
-  Do not place the product under direct sunlight or near heaters.
-  This product is designed to be used indoors. Do not use it outdoors. Otherwise, it may cause a malfunction.

Do not use or store the product in the following places.

- 
 - Near heaters
 - Places with lots of humidity or dust, or places subject to oily smoke
 - Places where water or oil may splash
 - Places with lots of corrosive gases, such as near hot springs
 - Places where the product may freeze
 - Do not place the product on its side, face down, or upside down.
 - Places with lots of vibrations

 If you will not be using the product for a long time, disconnect it from the power distributor for safety purposes.

 Disconnect the power supply when performing the maintenance.

 Install the product in accordance with the local laws and regulations.

 Use ESD gloves when handling Pixel cards to prevent static electricity from the human body and contamination due to finger oils, perspiration salts, flaking skin, and/or other forms of human excretory secretions. The LED modules and their electrical components are sensitive to biological agents and exposure to such risks degradation of materials and performance. Eliminate any static electricity from your body before touching the Pixel cards by touching an aluminum sash, a door knob, or some other metal object.

This product can only be serviced in the country where it was purchased.

Recommended Use & Maintenance

About the LED lamps



The surface of the pixel card is vulnerable to shocks, so do not press or hit the surface.



LED lamps are sensitive to static electricity and surge voltage, which may damage their components and decrease their reliability.

Take measures against static electricity during the installation. Do not touch the LED display areas.

The LED lamps may absorb and hold moisture during the LED module installation or if not used for a long time. Therefore, in such cases, the brightness must be increased gradually during a break-in period before setting the normal brightness.



If the LED lamps are lit with 100% brightness while moisture is retained, the temperature will rise very quickly and the water inside the lamps will evaporate and expand. This will cause the encapsulating resin to expand, which may lead to separation of the boundary surface inside the LED lamps. This separation can cause the LED lamps not to light up properly.

Lamp break-in

Configure the brightness settings as shown below with a video displayed on the LED module.

After a break-in period of approximately 3 hours, the LED module can be used under normal conditions.

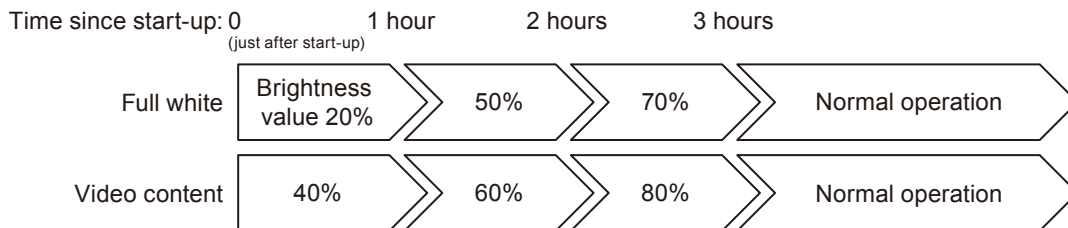

Pixel card surface cleaning

The surface of the pixel card is easily scratched, so handle it with care so as not to push or rub it with a hard object. Be careful not to stain the surface of the pixel card with your fingers. If the surface of the pixel card becomes dirty, wipe it gently with a dry cloth. Also, use a clean cloth and avoid using the same cloth repeatedly.

Contents

The supplied parts are as follows.

In case one of these parts is missing or damaged, contact the retailer.

CAUTION

Depending on the system you ordered, there is a cabinet without the upper connector.

[Cabinet]

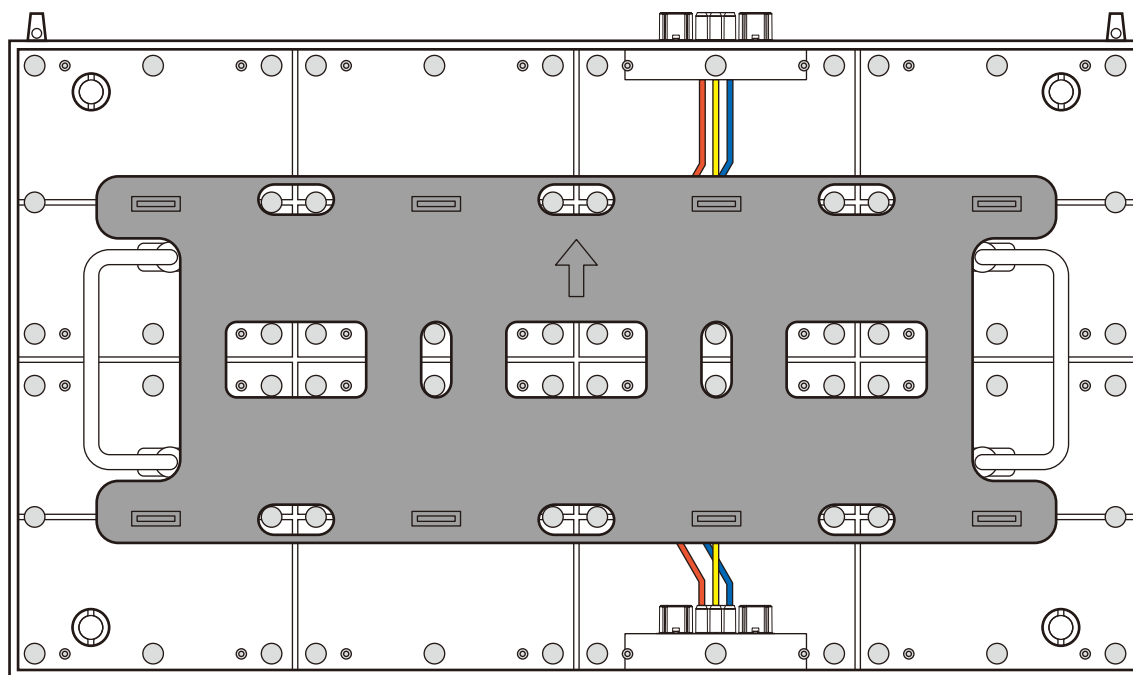

[Pixel card]

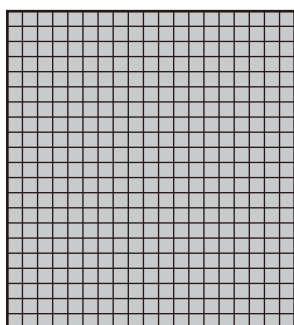

8 cards per cabinet

Related Items for Installation

The items required when installing the system are shown below.
Contact your retailer for more details.

[Power cord]

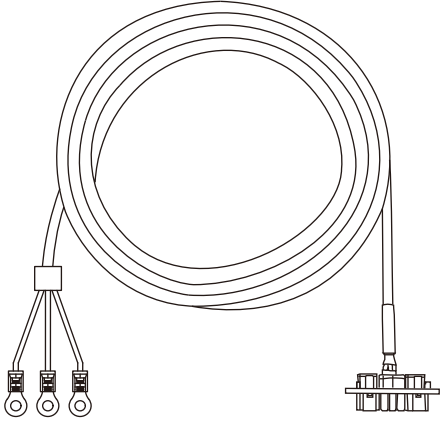

To connect the LED module to the power distributor

[LAN cable]



To connect two LED modules together
(120 mm for vertical connection, 1000 mm for horizontal connection)

[Cabinet alignment bracket]

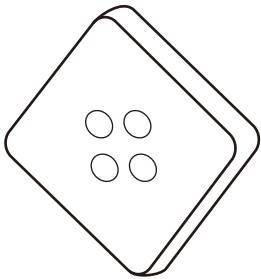

[Connection screw for LED modules]



[USB drive]

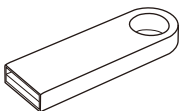

Contains the data, the user's manual (this document), and
the control software for the product you have purchased.

Parts Name

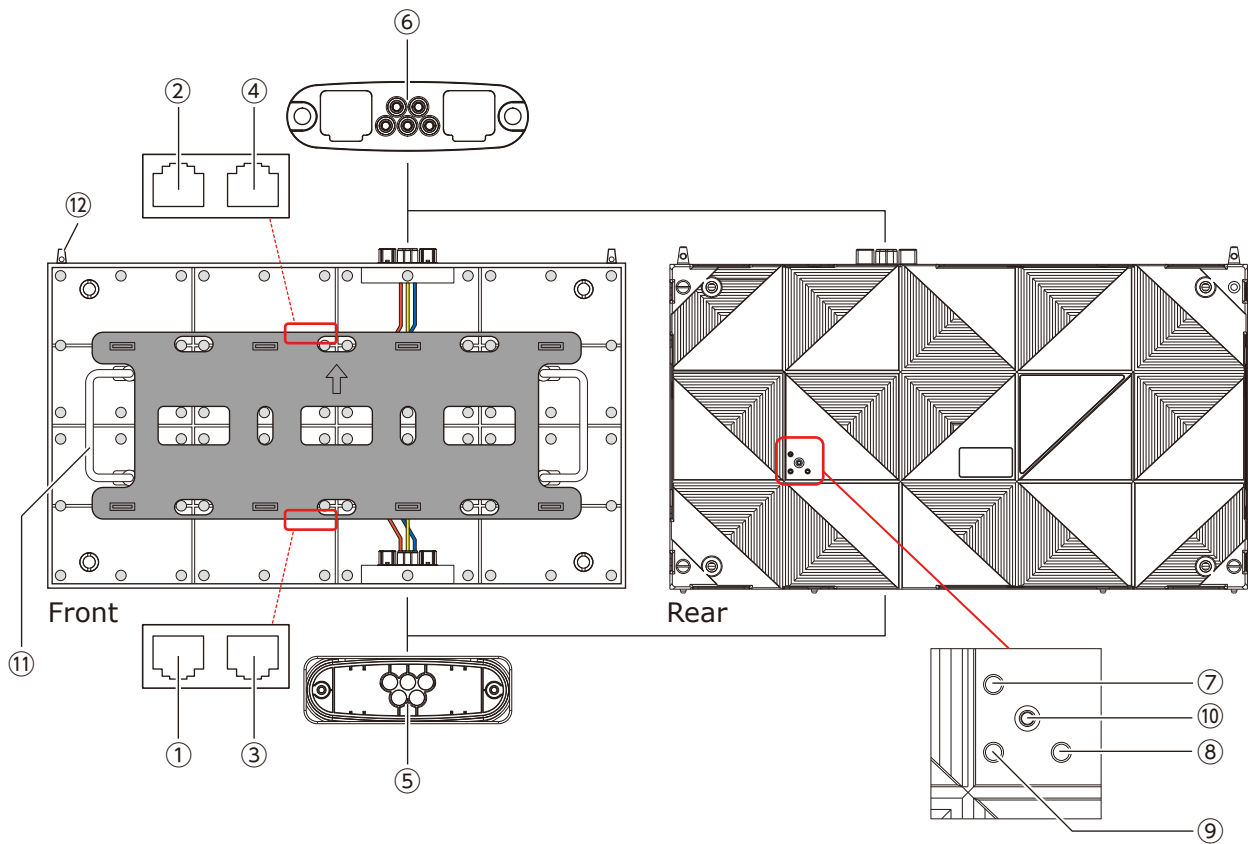

Name	Description
Interface connectors	Input and output connectors for the signal and AC power.
①② Signal input/output	To input the signal from the LED controller or the previous LED module. When a signal is input into ①, the signal is output from ②. When a signal is input into ②, the signal is output from ①.
③④ Signal input/output	Not functioning with this product.
⑤⑥ Power input (output)	When AC power is input into ⑤, AC power is output from ⑥. When AC power is input into ⑥, AC power is output from ⑤. Do not input AC power into both ⑤ and ⑥.
⑦ Status lamp (red)	Flashes when a signal is being input.
⑧ Status lamp (blue)	Not functioning with this device.
⑨ Status lamp (green)	Lights up when power is being input.
⑩ Test button	Used to display the test patterns. The displayed pattern changes each time the test button is pressed. The signal from the LED controller must be interrupted to display a test pattern.
⑪ Handle	Use the handles when carrying and installing the cabinet.
⑫ Guide pin	Used to align the cabinets when installing them on top of each other.

There are two types of cabinets.

(1) Type A

The connectors are equipped on the top and bottom sides. There are guide pins on the top.

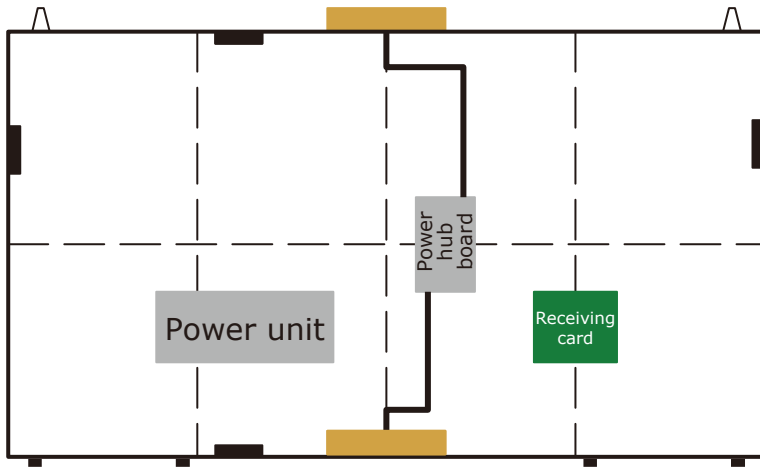

(2) Type B

There are no connectors on the top side. There are no guide pins.

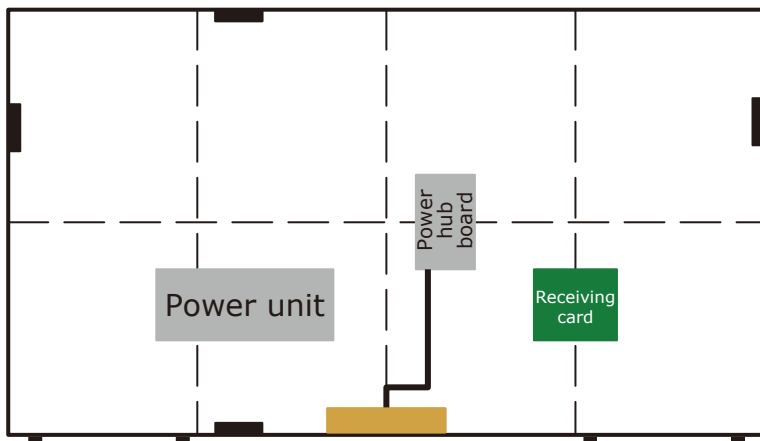

[When assembling a 6 x 6 frame set using FC009i]

It is necessary to connect a LAN cable in the middle of the installation work. That is the reason why a model (Type A') with a hole for LAN cable connection on the rear has been made available.

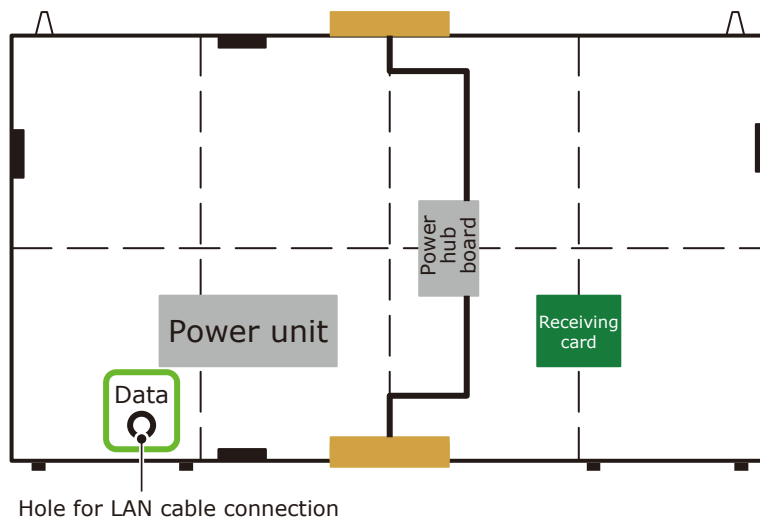

Installation Example

1. Installation location

Before the installation, be sure to review the following safety precautions to ensure proper and safe installation.

⚠ CAUTION

- Ask a technician to perform the installation.
- Make sure the product is moved and installed by enough people to ensure safety.
- Make sure that the beams or the other structures to which the product is installed have enough strength to support the weight of the product, and make sure that the product is securely fixed.
- Do not install directly the product to a surface that has not enough strength.
- When installing the product in a narrow place (in a wall, etc.), leave enough gaps around the LED screens to prevent an increase in the temperature.

Make sure to use the product lower than the normal operating temperature.

Pay particular attention to the installation environment (heat from the external environment, direct sunlight, heat generated by the number of displays) in order to facilitate cooling of the LED modules.

If cooling is not sufficient, take measures, such as increasing the distance from the walls or installing a forced-air cooling system.

Ask a technician or your retailer for more details.

There is an example for setting.

In wall setting

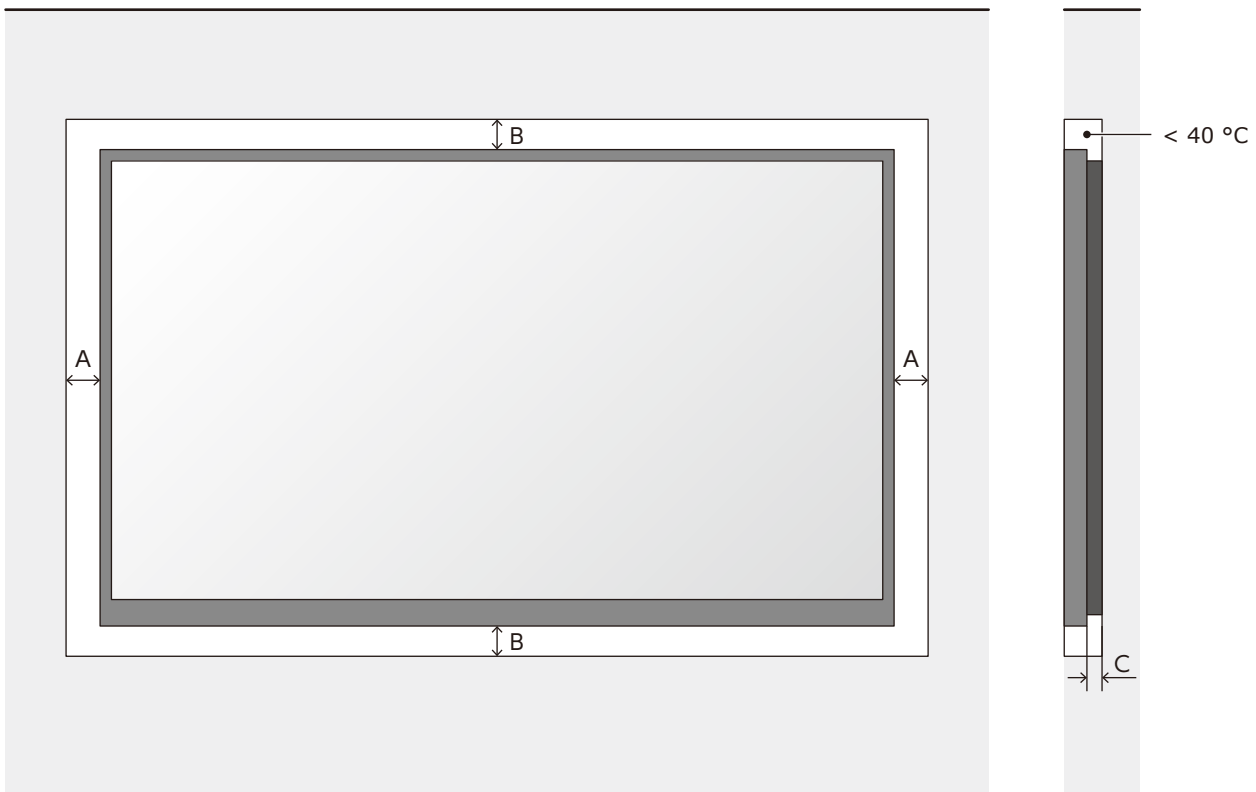

A	B	C
min distance to sides	min. distance to top and bottom	Distance between wall and system
60 mm	60 mm	20 mm

Wall mounting setting

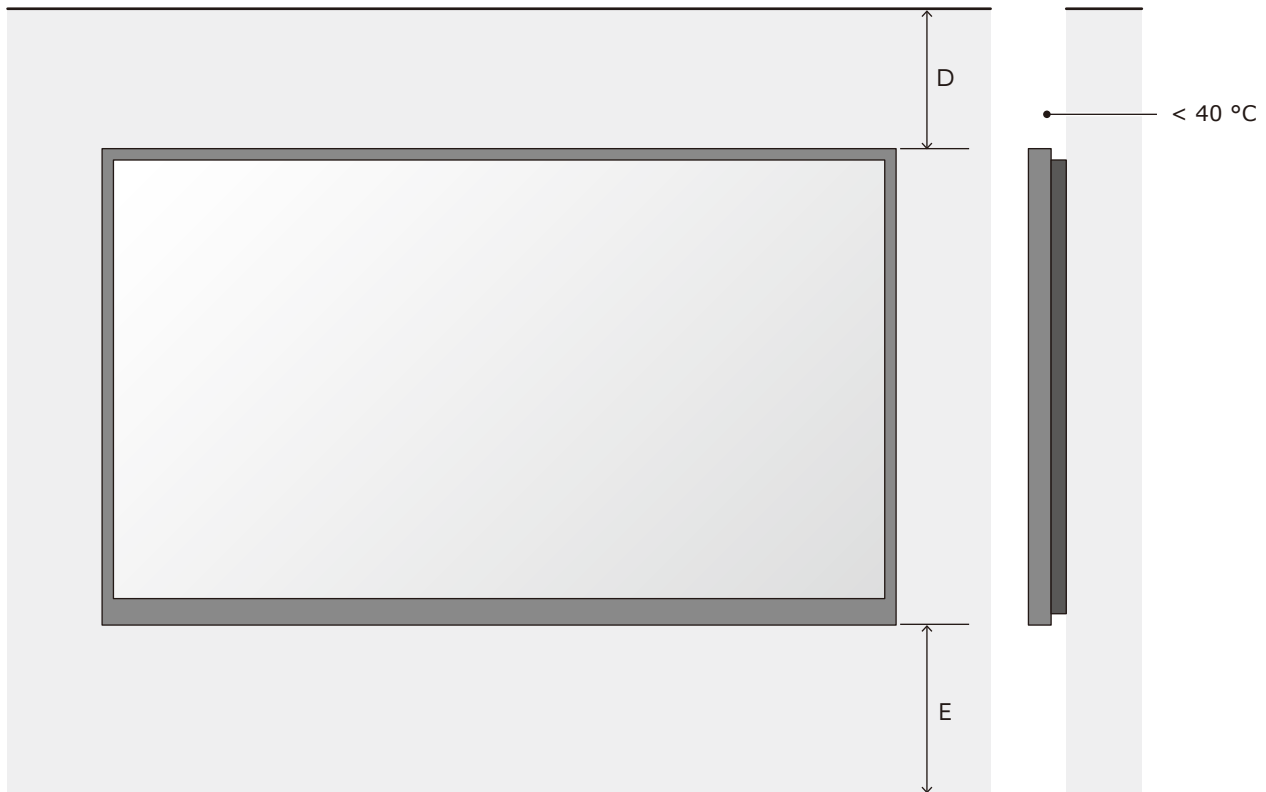

D	E
min. distance to ceiling	min. distance to floor
60 mm or more	60 mm or more

2. Handle

Use the handles when carrying and installing the cabinet.

Put the handles in their original positions after the installation work has been completed.

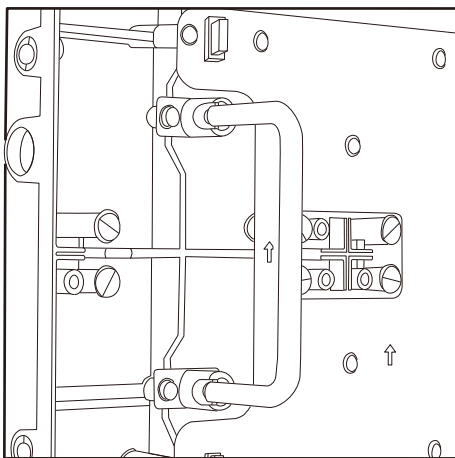

When carrying or installing the cabinet, pull out the handles on both sides.

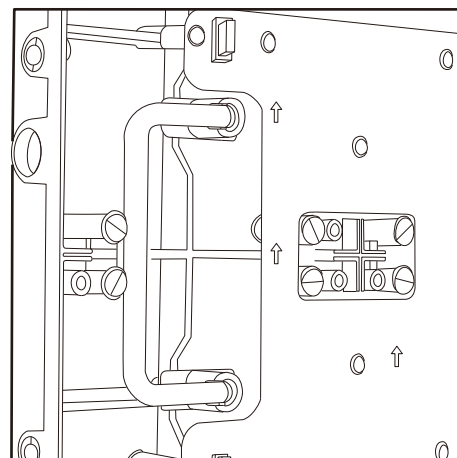

Put the handles back after the work has been completed.

3. Installation with brackets

A recommended example of installation when using the brackets is shown below. Ask a technician or your retailer for the installation procedure when not using the brackets.

Install the brackets to the frame as shown in the figure below.

Use screws with a length adapted to the cabinet thickness (30 mm). Use also brackets with a sufficient thickness to hold the screws.

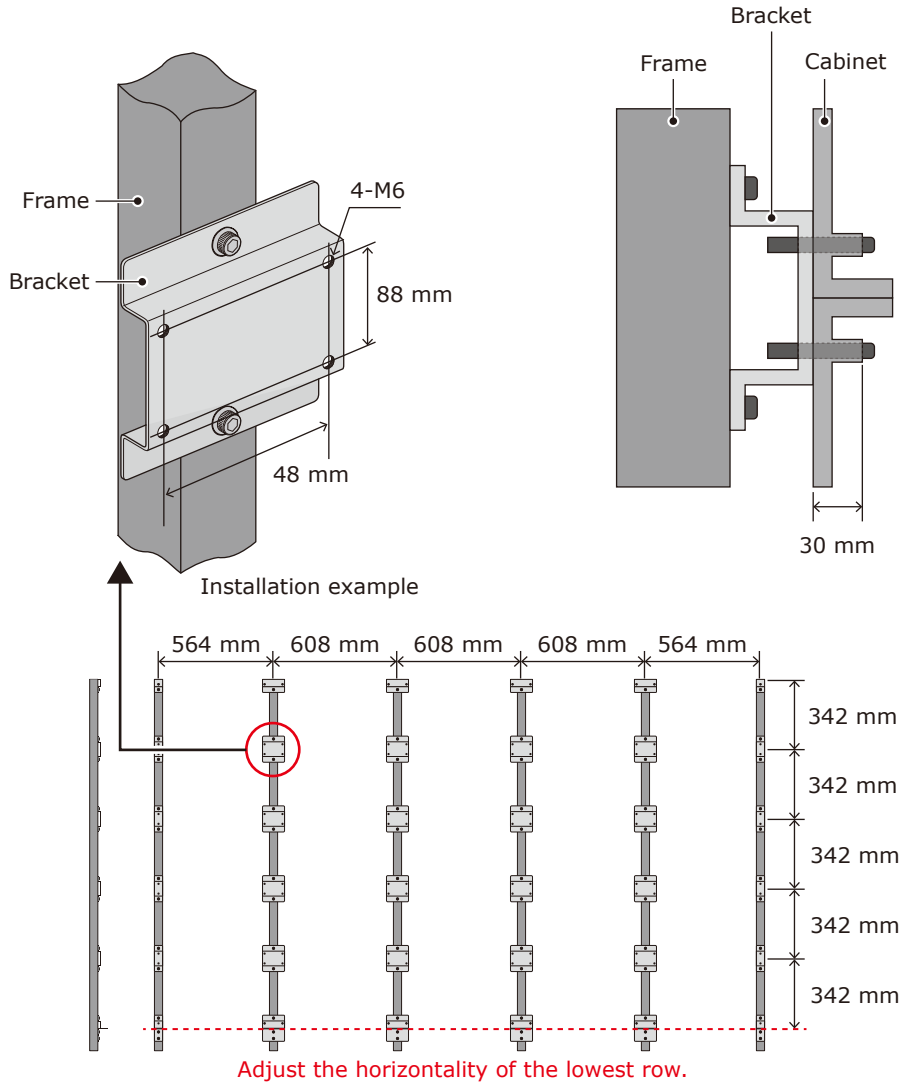

Install the LED cabinets starting from the bottom row.

First, secure temporarily the cabinets to the bracket using screws.

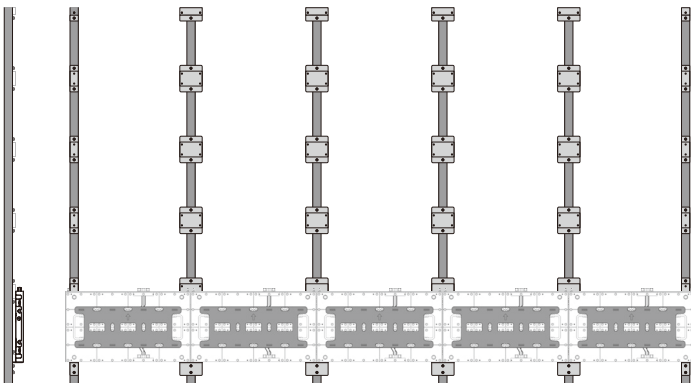

Then, secure the LED cabinets together using connection screws for LED modules. Do not tighten the screws completely.

After you have installed two rows of cabinets, align the surfaces of the cabinets using the Adjustment plate.

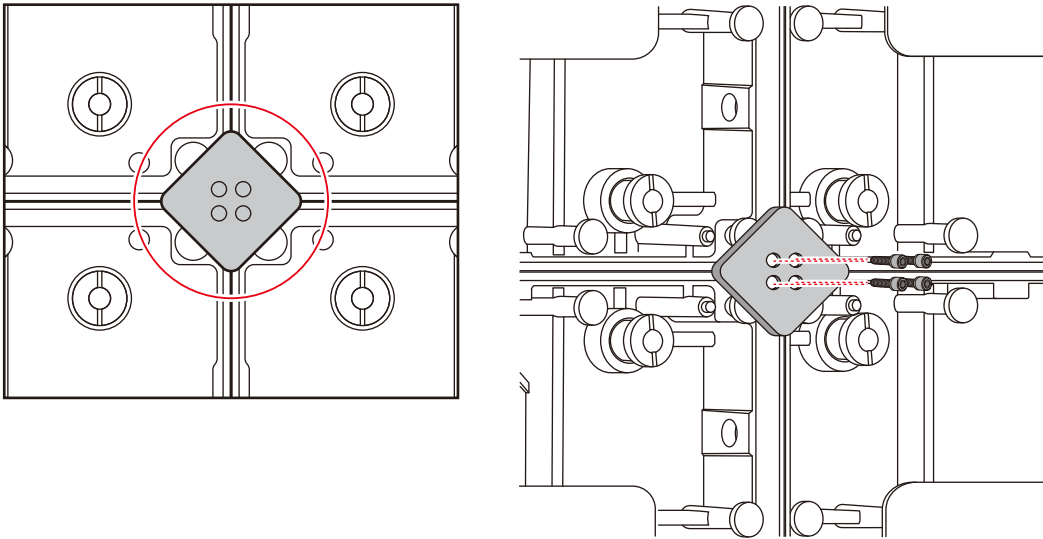

Secure the LED cabinets to the brackets with screws.

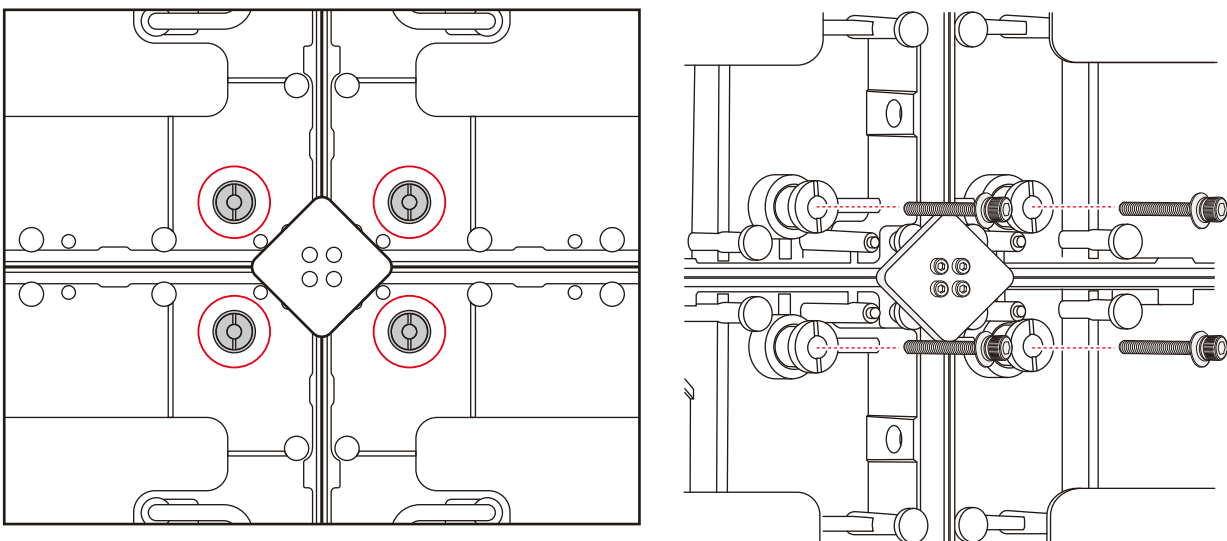

Secure the LED modules to each other with screws.

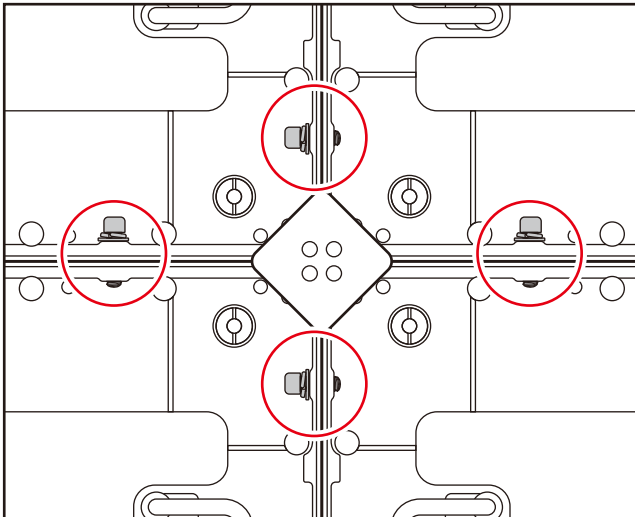

When the cabinets' surfaces are aligned, completely tighten the screws securing the cabinets together and the screws securing the cabinets to the brackets.

Remove the Adjustment plate after the screws have been tightened.

Follow the same procedure to install the next row of cabinets and align their surfaces.

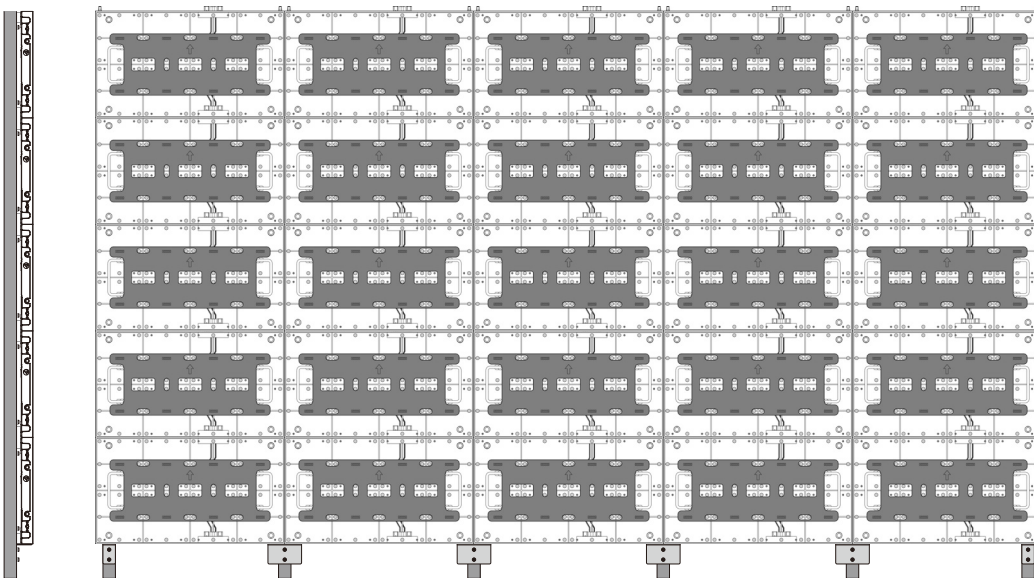

4. Installation with a wall-mount frame

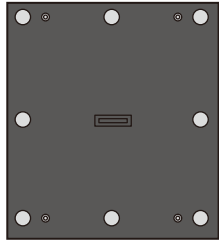
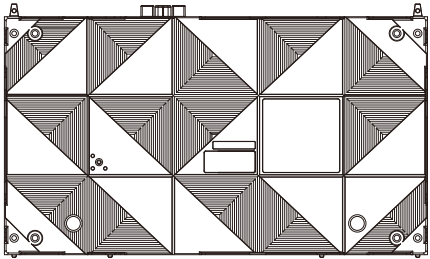
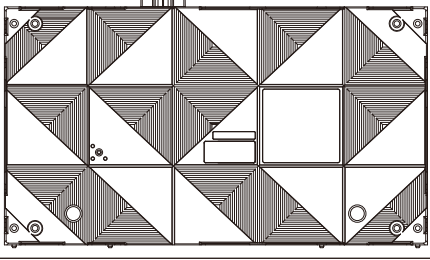
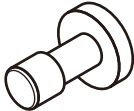
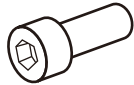
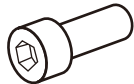
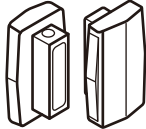
Parts	Specifications	Quantity				
		4 x 4 frame set (LED-FC012i)	5 x 5 frame set (LED-FC015i)	6 x 6 frame set (LED-FC009i)	8 x 8 frame set (LED-FC012i)	
Pixel card pitch 1.2, 1.5, 1.9, 3.8	152 x 171 x 10 mm	128	200	288	512	
Cabinet Type A (all rows except top row)	608 x 342 x 39 mm	12	20	30	56	
Cabinet Type B (only top row)	608 x 342 x 39 mm	4	5	6	8	
Cabinet hanger pin	Head diameter 15 mm, thickness 5 mm, M8 external dental pattern, axis length 17 mm, stainless steel color	24	48	60	96	
Power bar cover plate		1	1	1	2	
Power bar screw (M8x20)	Hexagon socket head screw	12	16	20	24	
Power bar		1	1	1	2	
Bottom frame connecting part		-	-	-	1	
Screw for Bottom frame connecting		-	-	-	2	
Screw for corner frame bottom (M6x12)	Hexagon socket head screw	2	2	2	2	
Corner frame bottom (left, right)		2	2	2	2	
Overframe (left, right)		2	2	2	2	
Mounting bar		3	4	5	6	

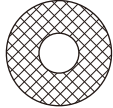
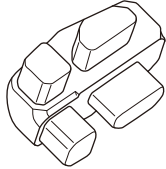
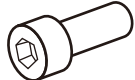
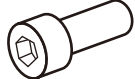
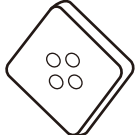
Parts	Specifications	Quantity				
		4 x 4 frame set (LED-FC012i)	5 x 5 frame set (LED-FC015i)	6 x 6 frame set (LED-FC009i)	8 x 8 frame set (LED-FC012i)	
Washer		12	20	30	48	
Corner frame top (left, right)		2	2	2	2	
Overframe (top)		1	1	1	2	
Screw for overframe (M8x16)	Hexagon socket head screw	10	12	12	14	
Screw for cabinet (to Power bar) (M8x16)	Hexagon socket head screw	8	10	12	16	
Adjustment plate		10	12	14	18	
Screw for connecting cabinets (M8x25)		48	80	120	224	
LAN cable between LED controller and module	120 mm	12	20	30	56	
Alignment bar		1	1	1	1	

Four different wall-mount frames can be used depending on the system size. Ask your retailer for more details.

4.1 Mark the positions of the anchor points on the wall

- Mark the positions of the holes you will make for the anchor points (refer to the figures below and the "Anchor points number and positions" table on the next page).
- Before making the holes, check the verticality of the marks using a spirit level.

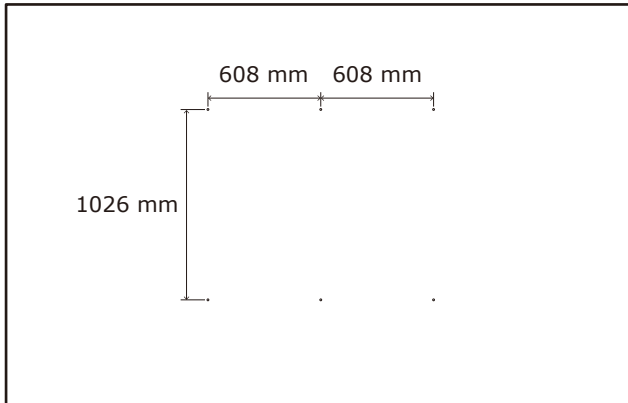

Anchor points positions: 4 x 4 frame set

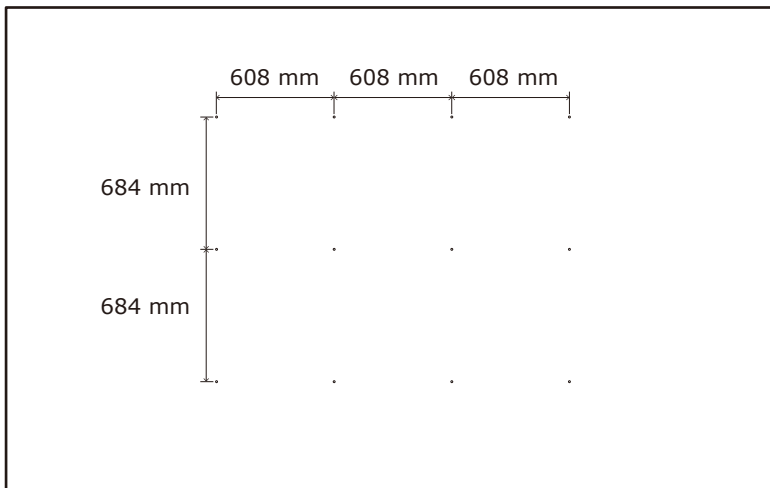

Anchor points positions: 5 x 5 frame set

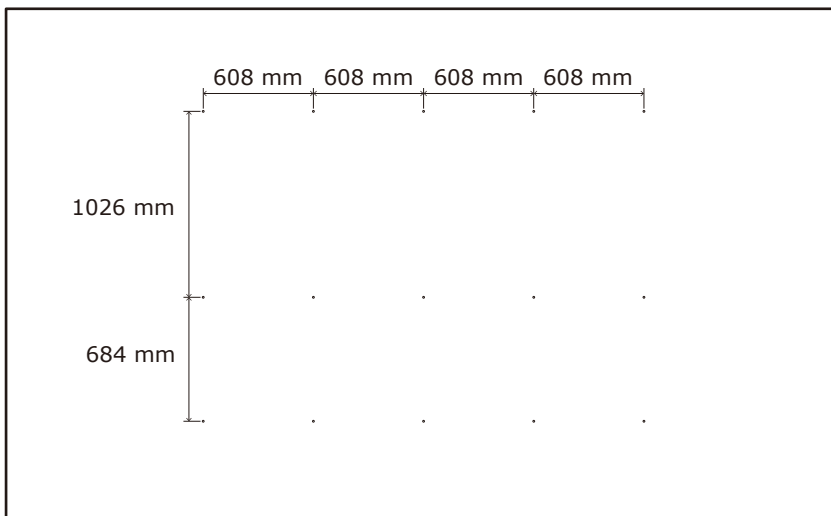

Anchor points positions: 6 x 6 frame set

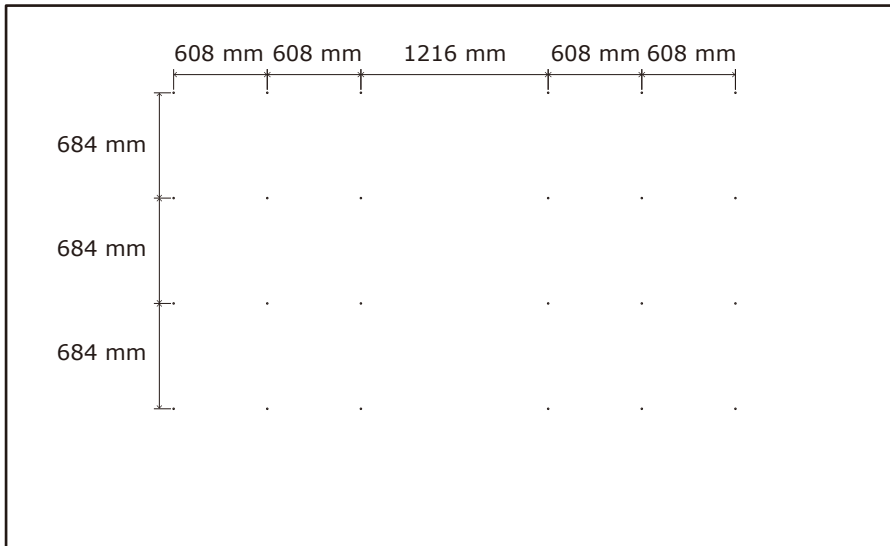

Anchor points positions: 8 x 8 frame set

Anchor points number and positions

Frame set	4x4	5x5	6x6	8x8
Anchor points (horizontal x vertical)	3x2	4x3	5x3	6x5
Horizontal distance	608 mm	608 mm	608 mm	Distance center: 1216 mm Others: 608 equally
Vertical distance	1026 mm	684 mm equally	Distance top row – middle row: 1026 mm Distance middle row – bottom row: 684 mm	Distance Bottom row: 342 mm, others 684 mm equally
Anchor size	Ø10 mm	Ø10 mm	Ø10 mm	Ø10 mm

4.2 Make the holes at the anchor positions

- Make holes at the anchor positions using a suitable tool.
- Use screw anchors/anchor plugs as required.
- Remove the dust or dirt, and wipe off any drilling chips and dust.

4.3 Install the mounting bars

- (1) Install the mounting bars on the anchor points on the wall.
- (2) Check the distance between the mounting bars using the alignment bars.

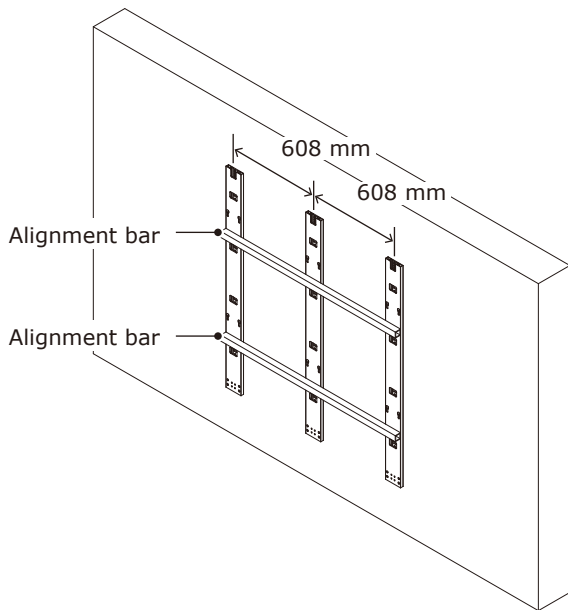

4 x 4 frame set

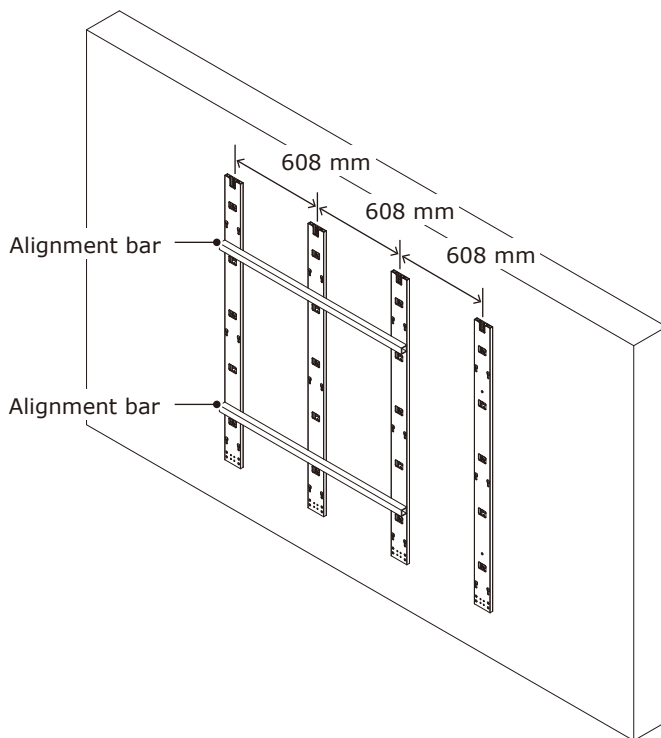

5 x 5 frame set

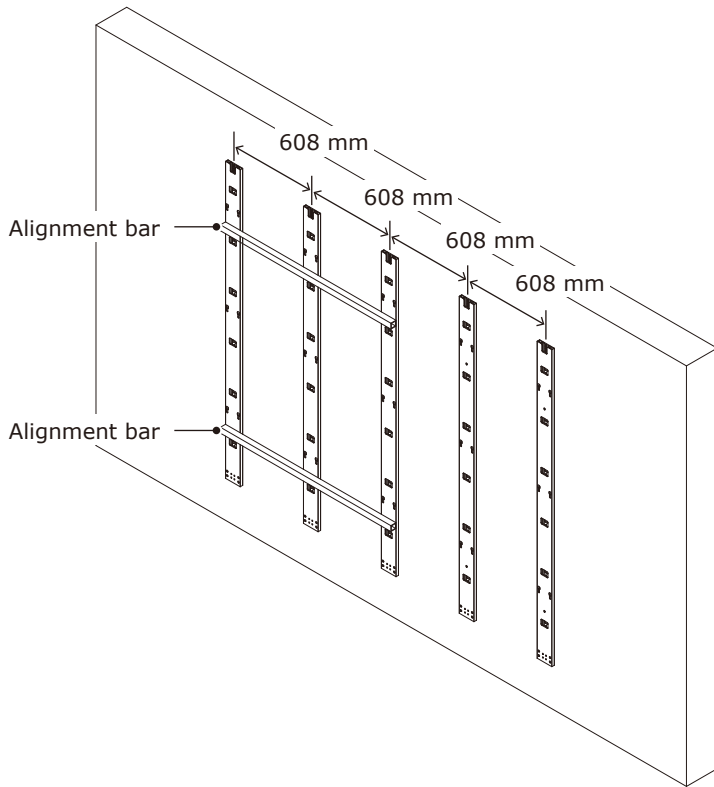

6 x 6 frame set

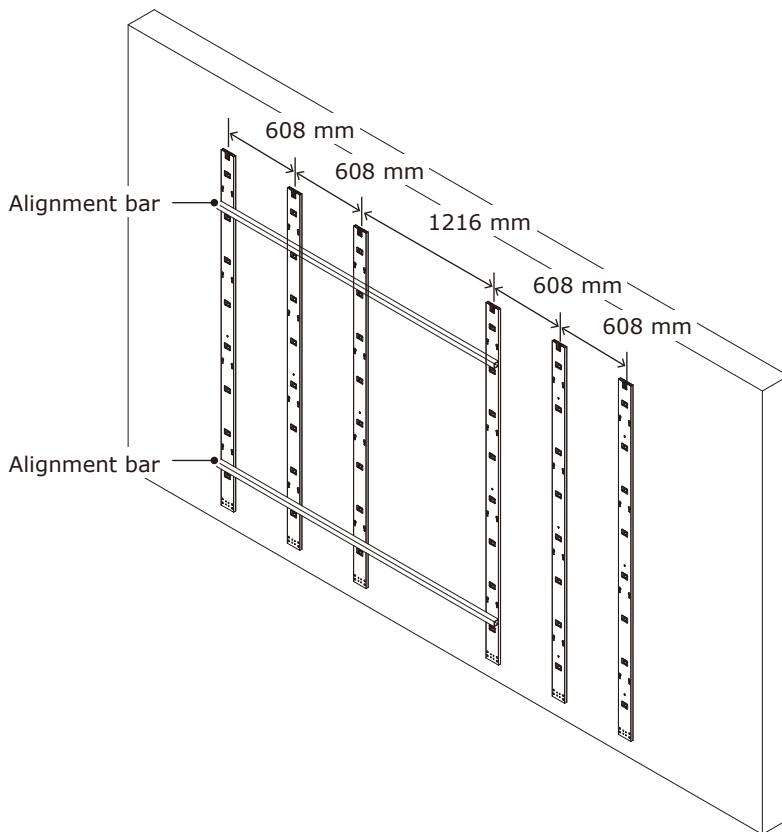

8 x 8 frame set

(3) Check the evenness using a spirit level and the alignment bars together. Adjust the positions if required.

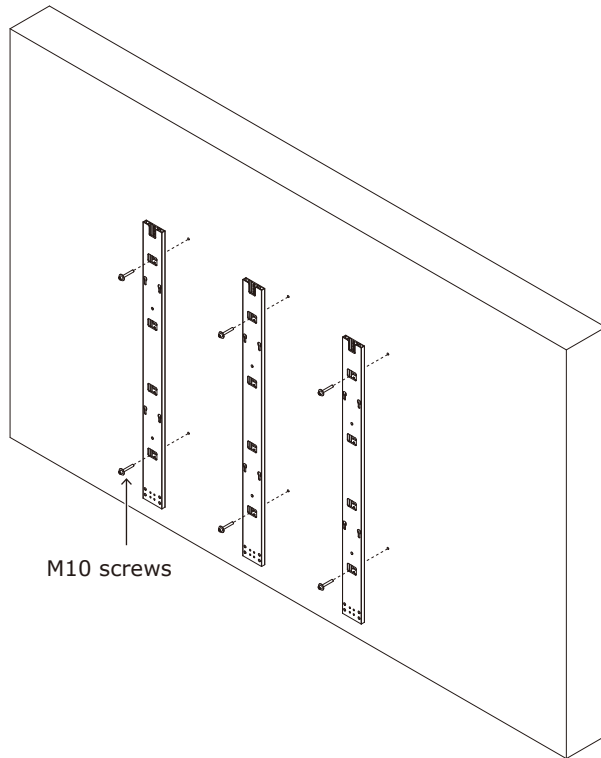

Wall mounted: Mounting bar installation (4 x 4 frame set)

4.4 Install the power bar

Remove the power bar cover and install the power bar using Power bar screw (M8) screws.

How to remove the power bar cover

Sliding the power bar cover for removing. Power bar cover can slide left or right.

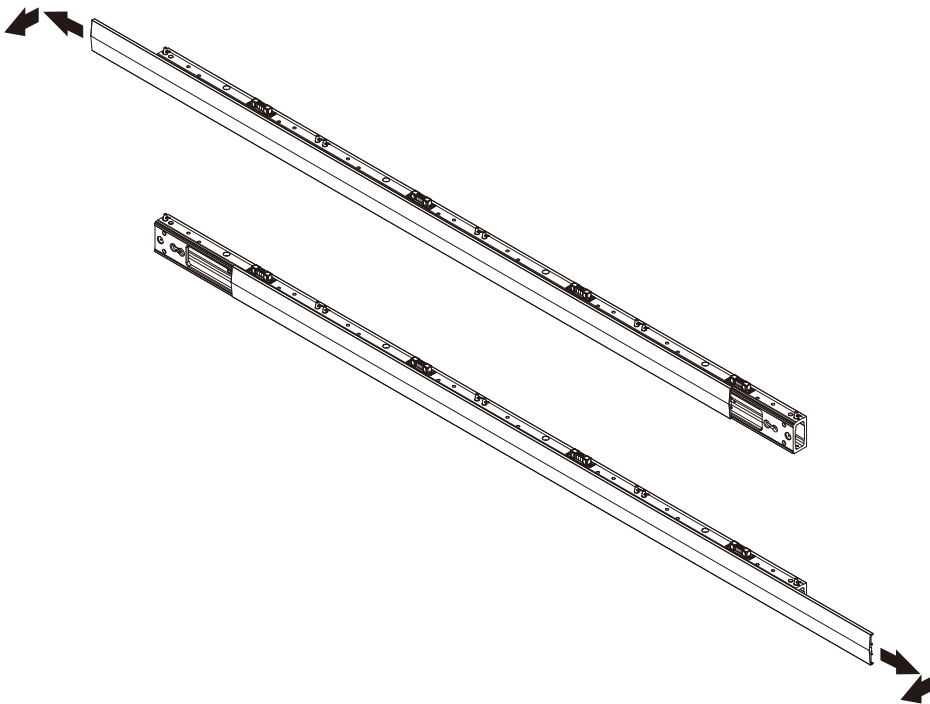

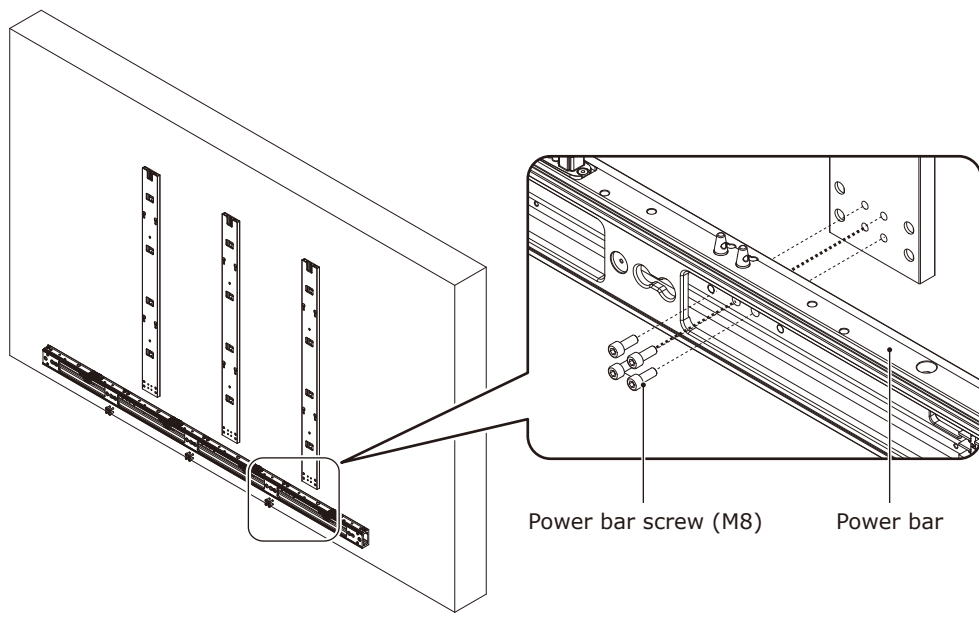

When using the 8 x 8 frame set, use the power bar connecting part to install the power bar.

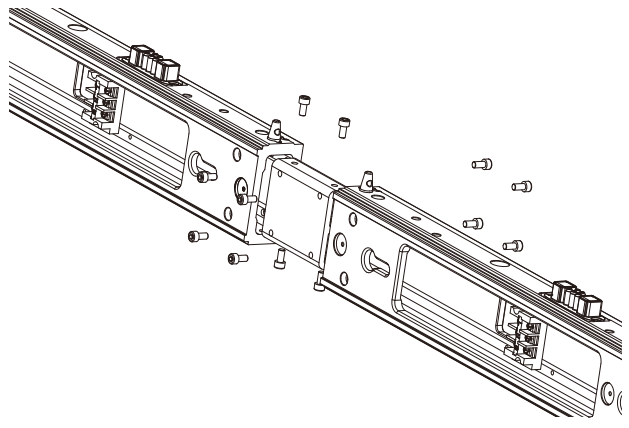

4.5 Install the cabinet hanger pins to the back of the cabinets

Turn the vertical alignment screw on the top corner of the cabinet so that it protrudes about 5 mm. Insert the hanger pins into the four corners of the cabinets up to where there is a difference in their diameter.

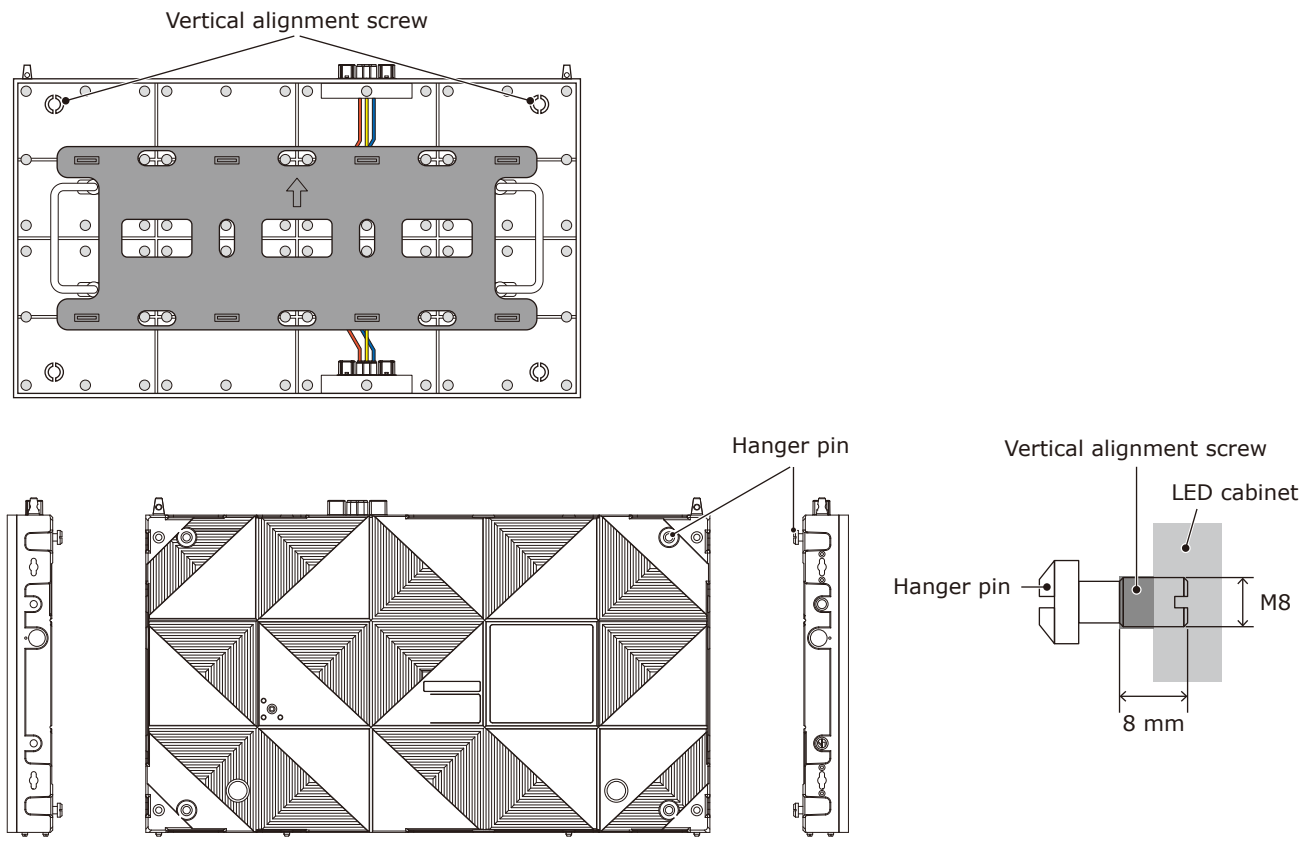

4.6 Install the cabinets

Hook the hanger pins, which have been inserted into the cabinets, into the holes on the mounting bars starting from the lowest row.

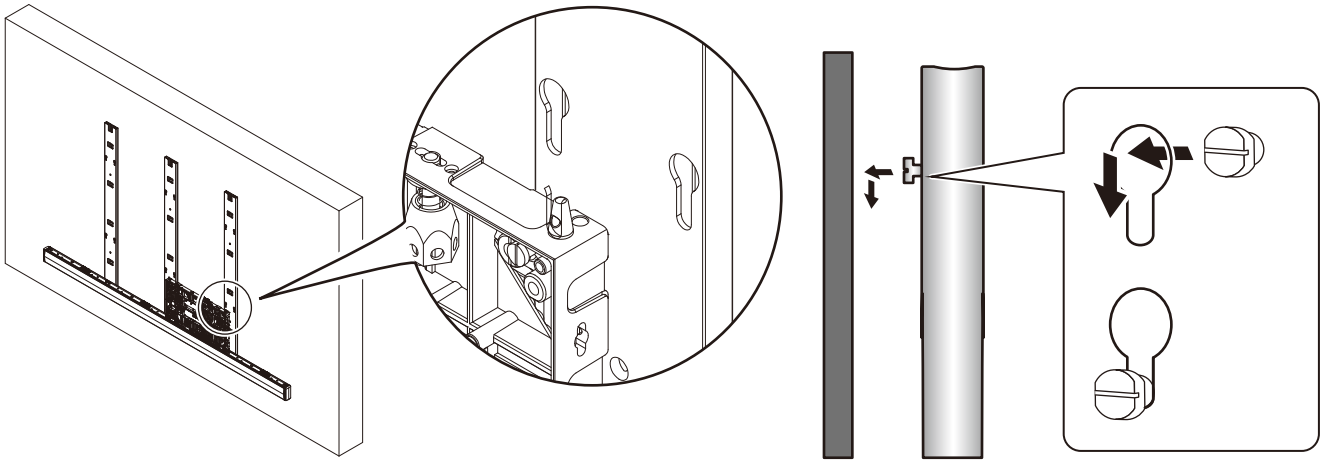

Fix temporarily the cabinets of the first row to the power bar.

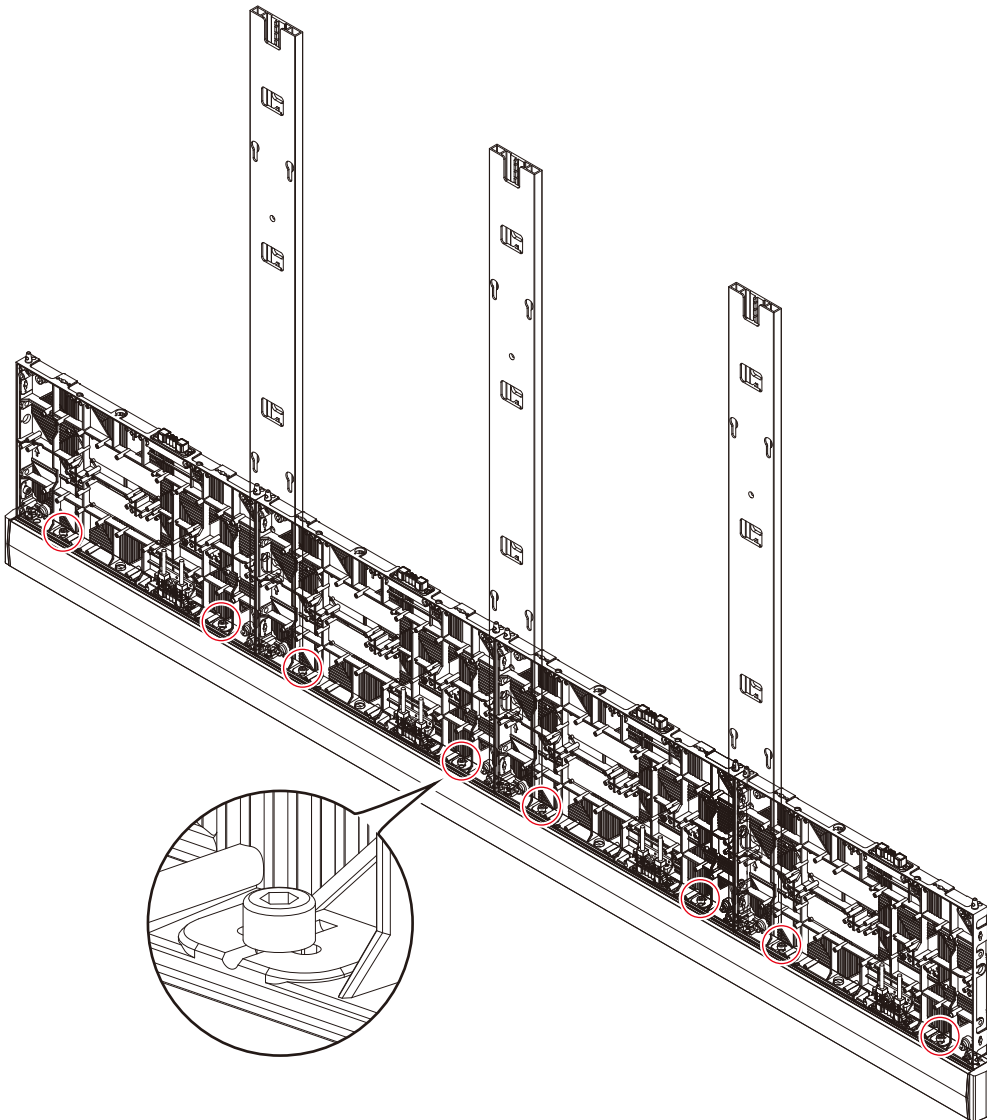

Hook the hanger pins of the cabinets of the second row to the mounting bars.
Secure the LED cabinets together using screws for connecting cabinets. Do not tighten the screws completely.

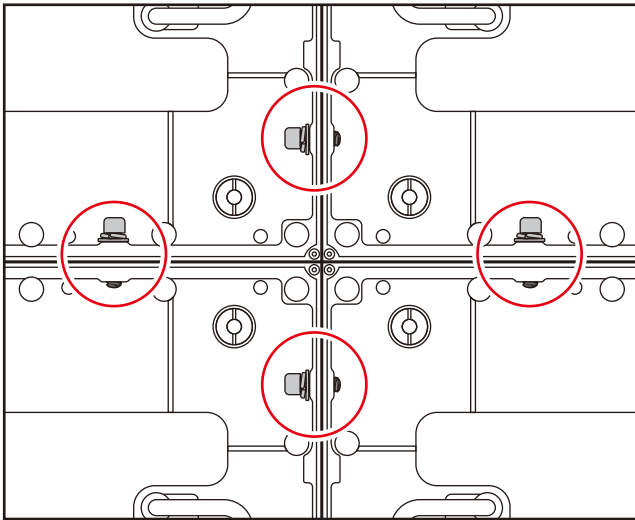

Turn the center of vertical alignment screw with a flathead screwdriver for align the cabinet position.

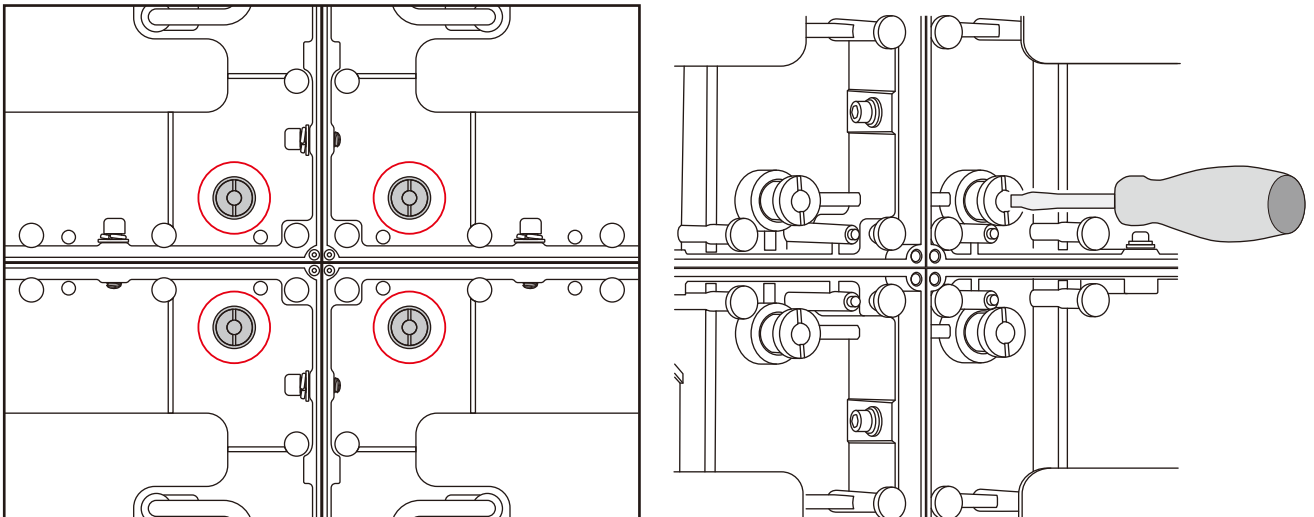

After you have installed two rows of cabinets, align the surfaces of the cabinets using the Adjustment plates.

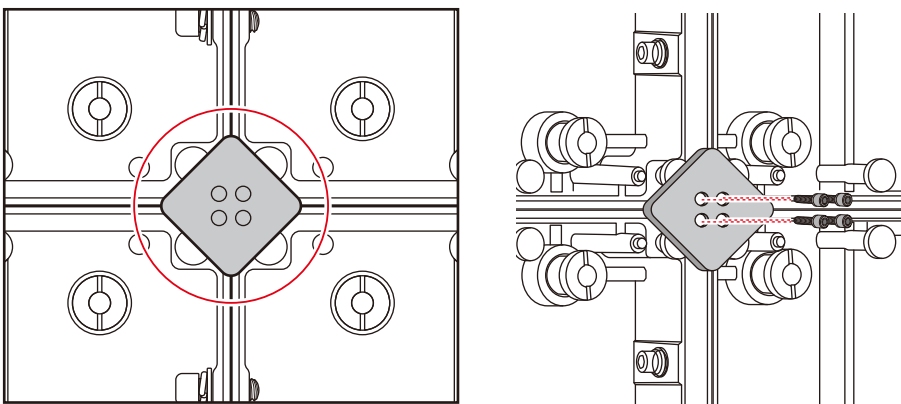

When the cabinets' surfaces are aligned, securely tighten the cabinets of the first row to the power bar, the cabinets of the first row together, as well as the cabinets of the first row with the cabinets of the second row. Remove the Adjustment plates after the screws have been tightened.
Follow the same procedure to install the next row of cabinets and align their surfaces.

Connect the power cord and the LAN cable from the opening at the back of the power bar.

How to connect the power cord

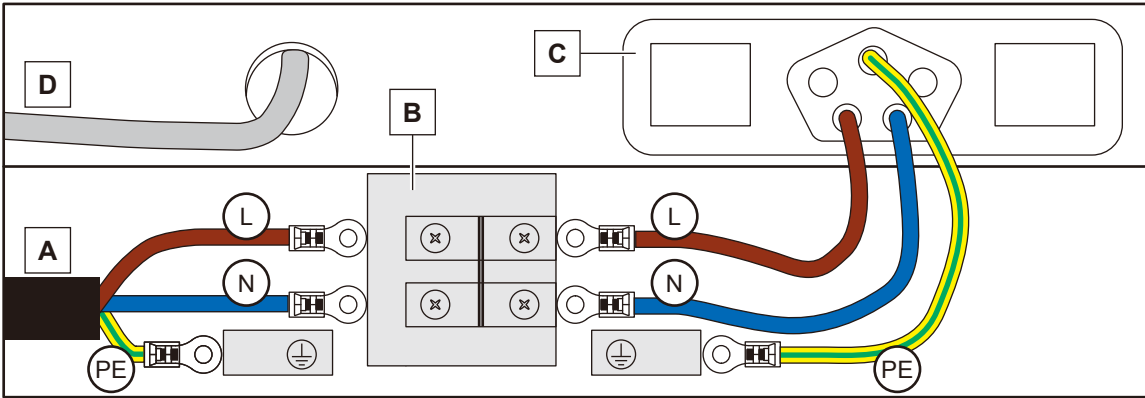

A	External power input
B	Terminal in Power bar
C	Power supply socket in Power bar
D	Data cable

⚠ WARNING

Pay attention to the wire colors of the power cord when connecting the cord. If the cables are not connected correctly, it may lead to a fire or an electrical shock.

- Blue (N)
- Brown (L)
- Yellow green (Ground)

⚠ CAUTION:

When attaching two cables with one screw, place the ring terminals of the cables back to back.

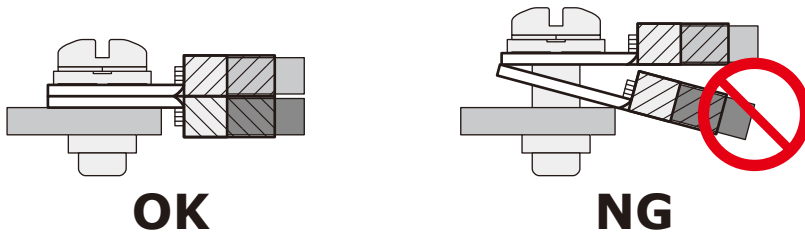

Install the power bar cover.

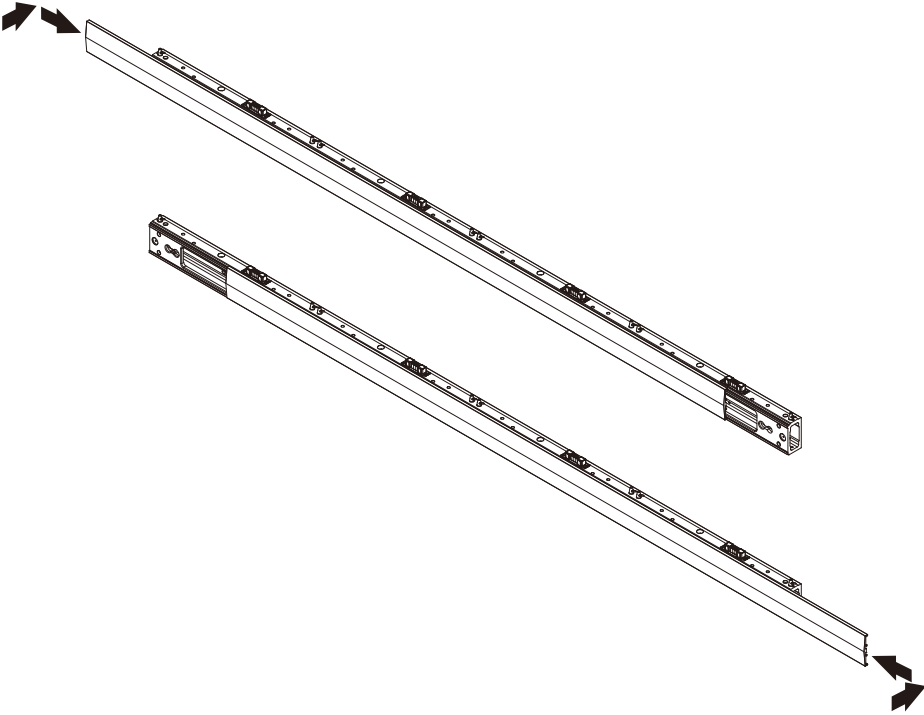

Insert the slot nuts inside the over frame into the holes of the screw for connecting cabinets and fix them with screw for overframe (M8) screws.

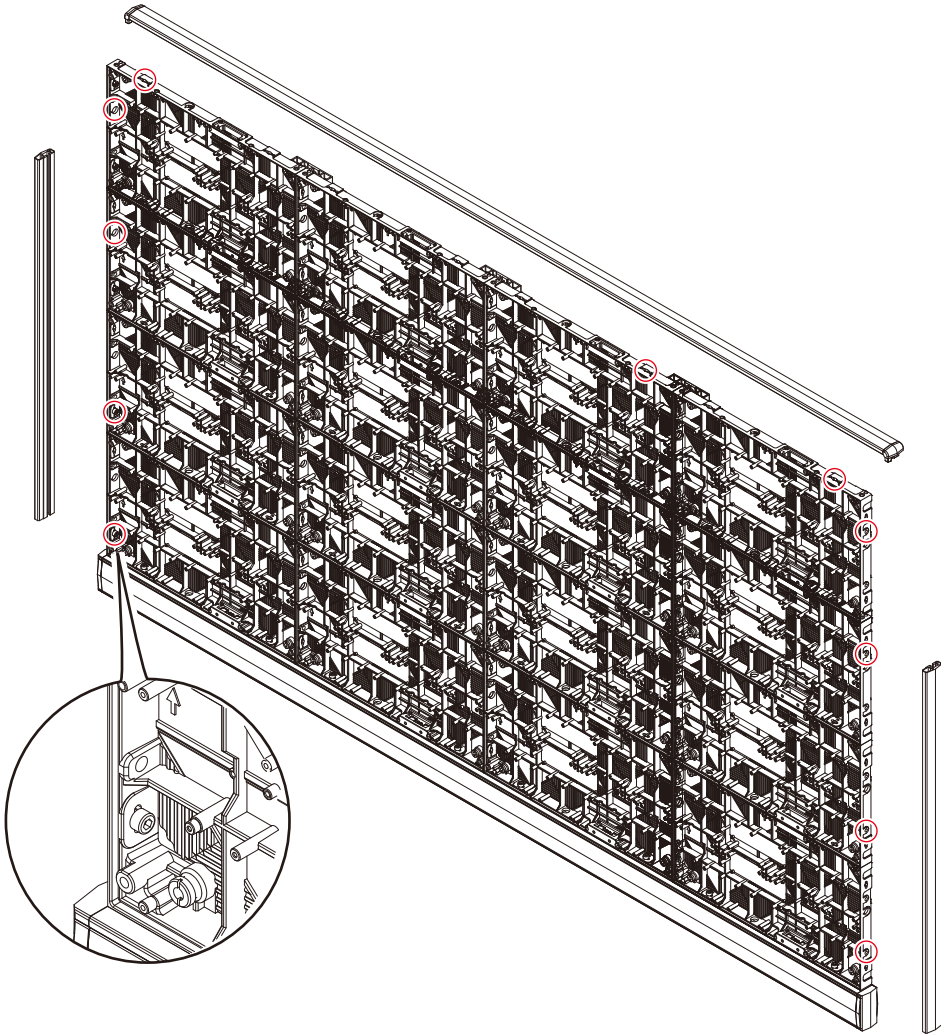

Install the corner parts to the corner frame top and install it on the top of the cabinets.

Slot nut installation locations

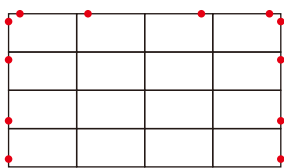

4 x 4 frame set

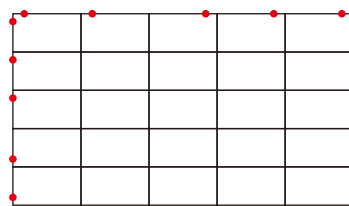

5 x 5 frame set

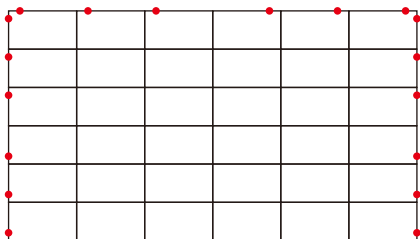

6 x 6 frame set

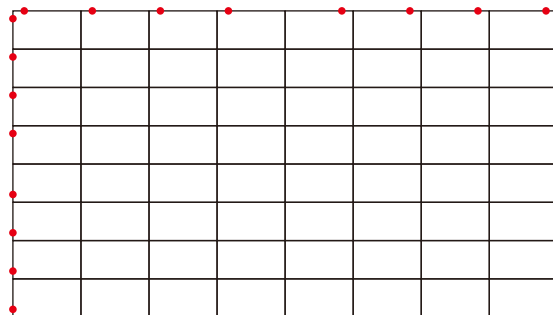

8 x 8 frame set

4.7 Assembly diagrams

4 x 4 frame set

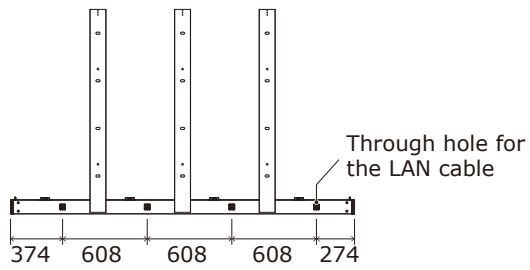
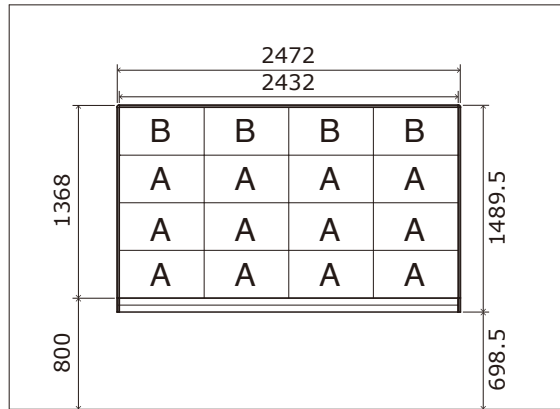
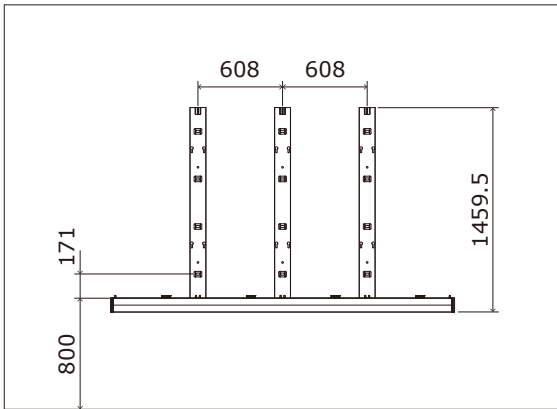

5 x 5 frame set

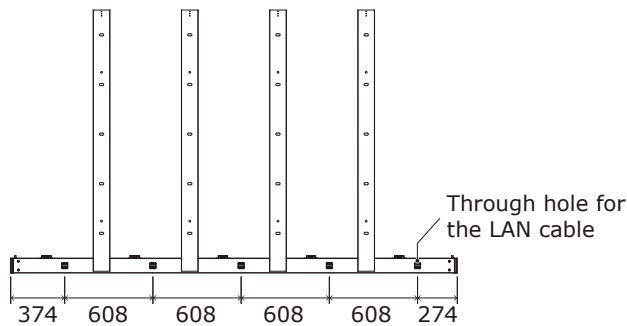
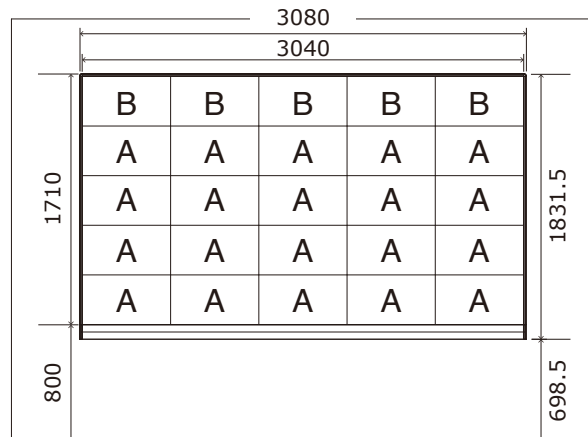
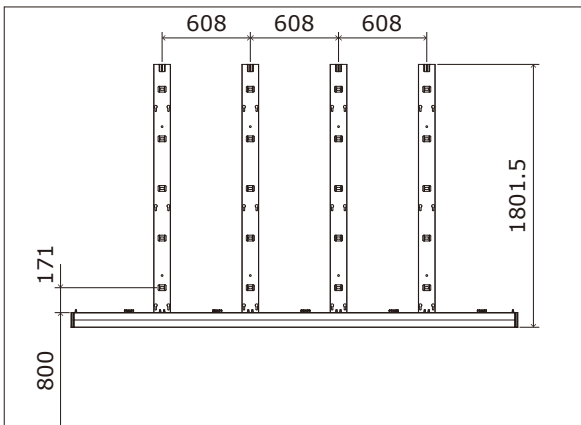

6 x 6 frame set

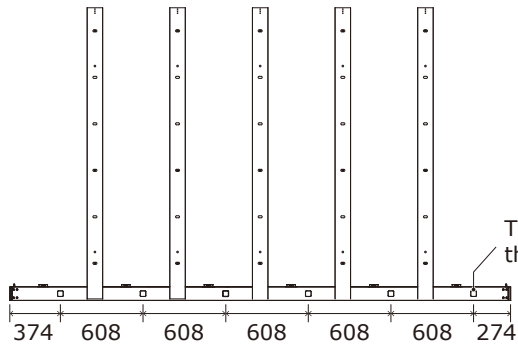
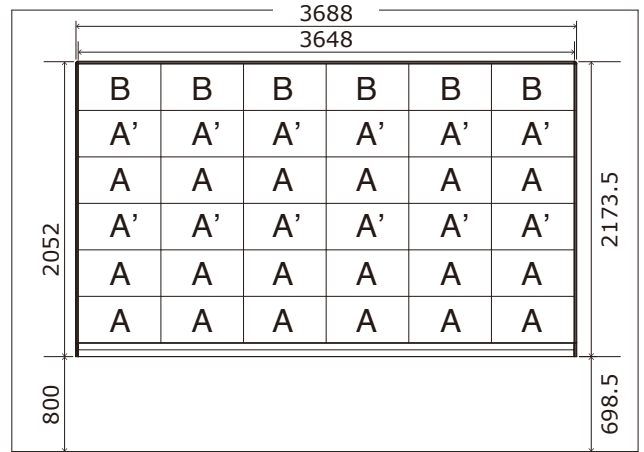
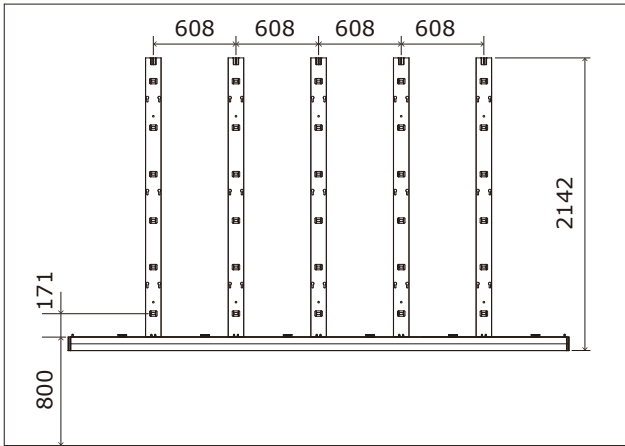

8 x 8 frame set

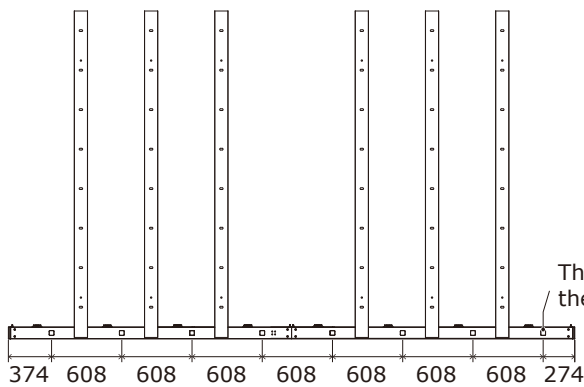
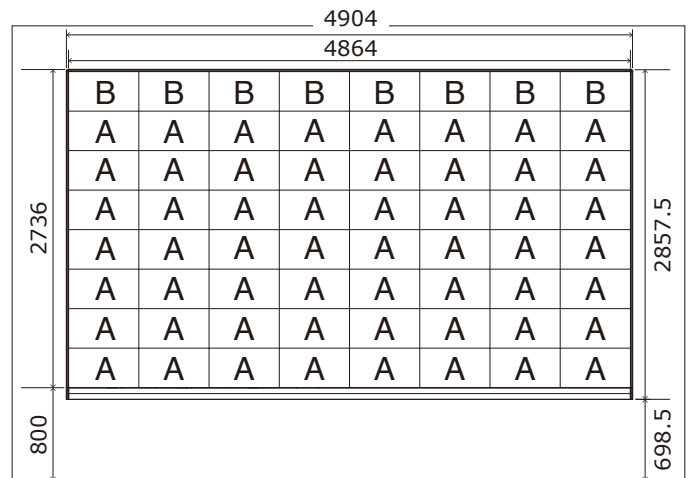
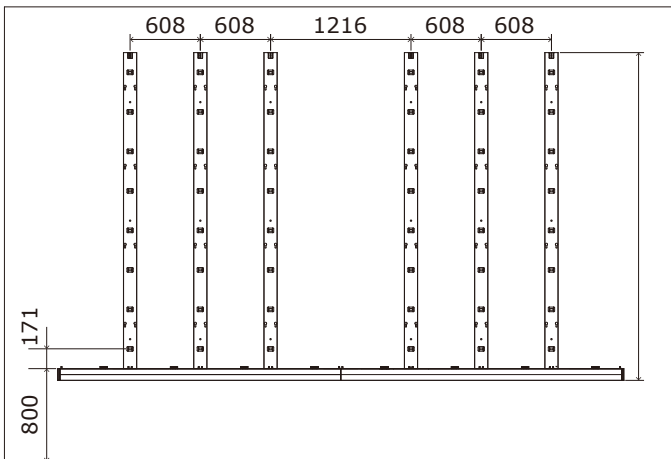

5. Wiring

(1) Maximum number of signal connections

The maximum number of connections per LAN cable is shown below.

Product name	Maximum number of connections
LED-FC009i	2 modules
LED-FC012i	5 modules
LED-FC015i	7 modules

⚠ CAUTION

The maximum number of connections may differ depending on the connected LED controller. Therefore, check the specifications of the LED controller you are using. Ask a technician or your retailer for more details.

(2) Maximum number of power connections

⚠ CAUTION

Exceeding the maximum capacity may generate smoke or cause a fire. Check the voltage used and do not exceed the connection limits shown below.

Product name	100 - 120 V AC	200 - 240 V AC
LED-FC009i	20 modules	40 modules
LED-FC012i	20 modules	40 modules
LED-FC015i	20 modules	40 modules

(3) Connection when using a wall-mount frame

4 x 4 frame set (LED-FC012i)

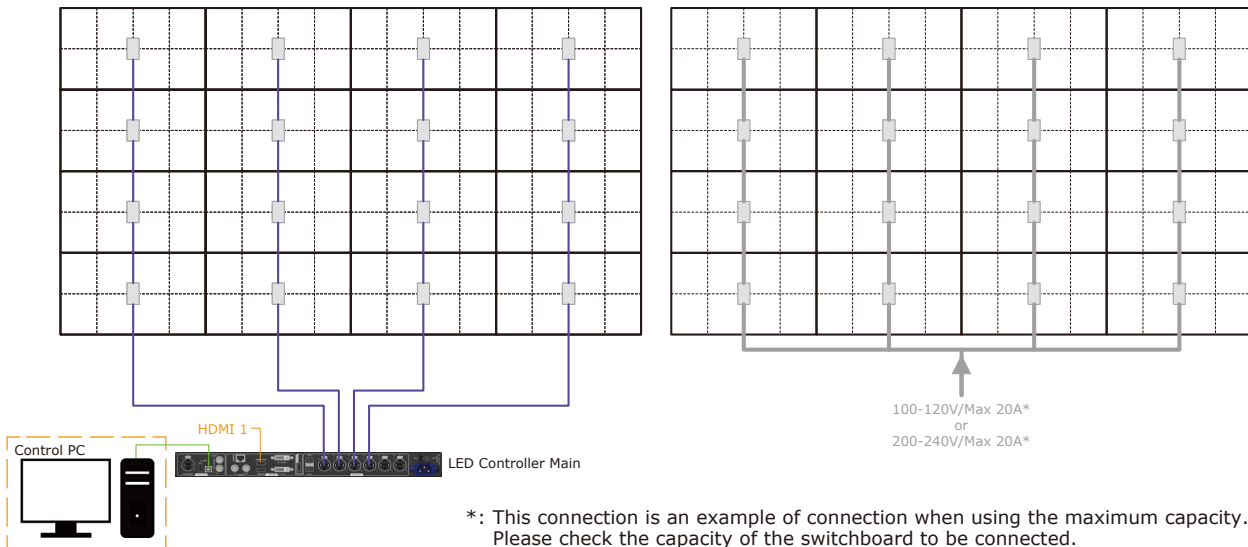

*: This connection is an example of connection when using the maximum capacity. Please check the capacity of the switchboard to be connected.

5 x 5 frame set (LED-FC015i)

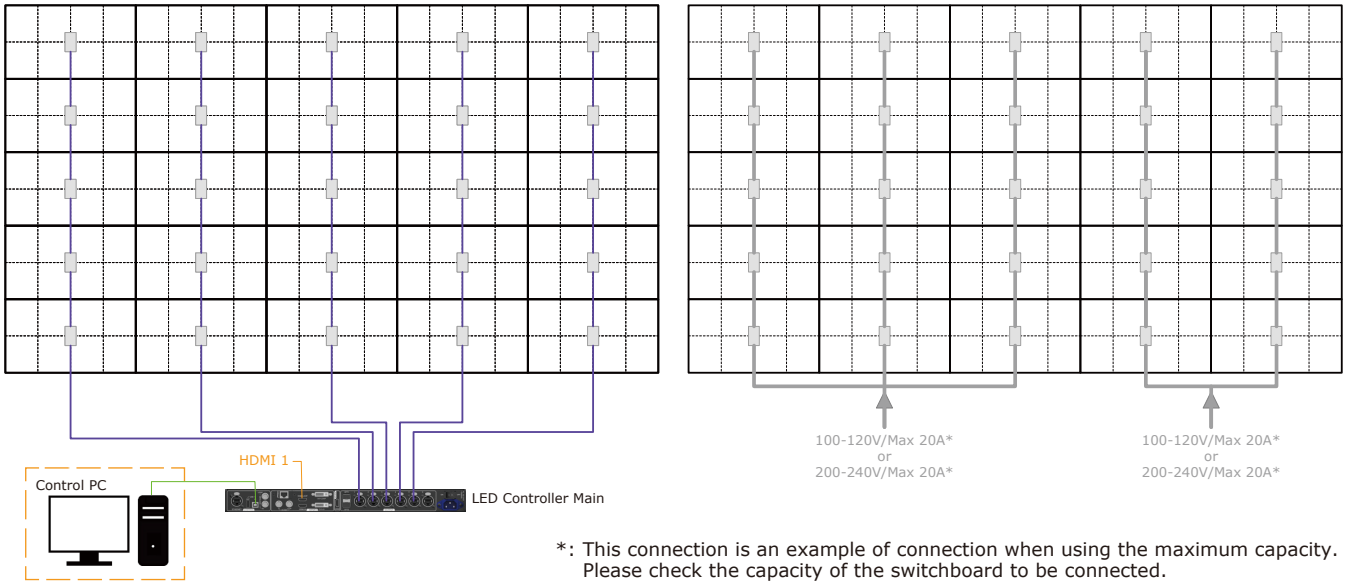

6 x 6 frame set (LED-FC009i)

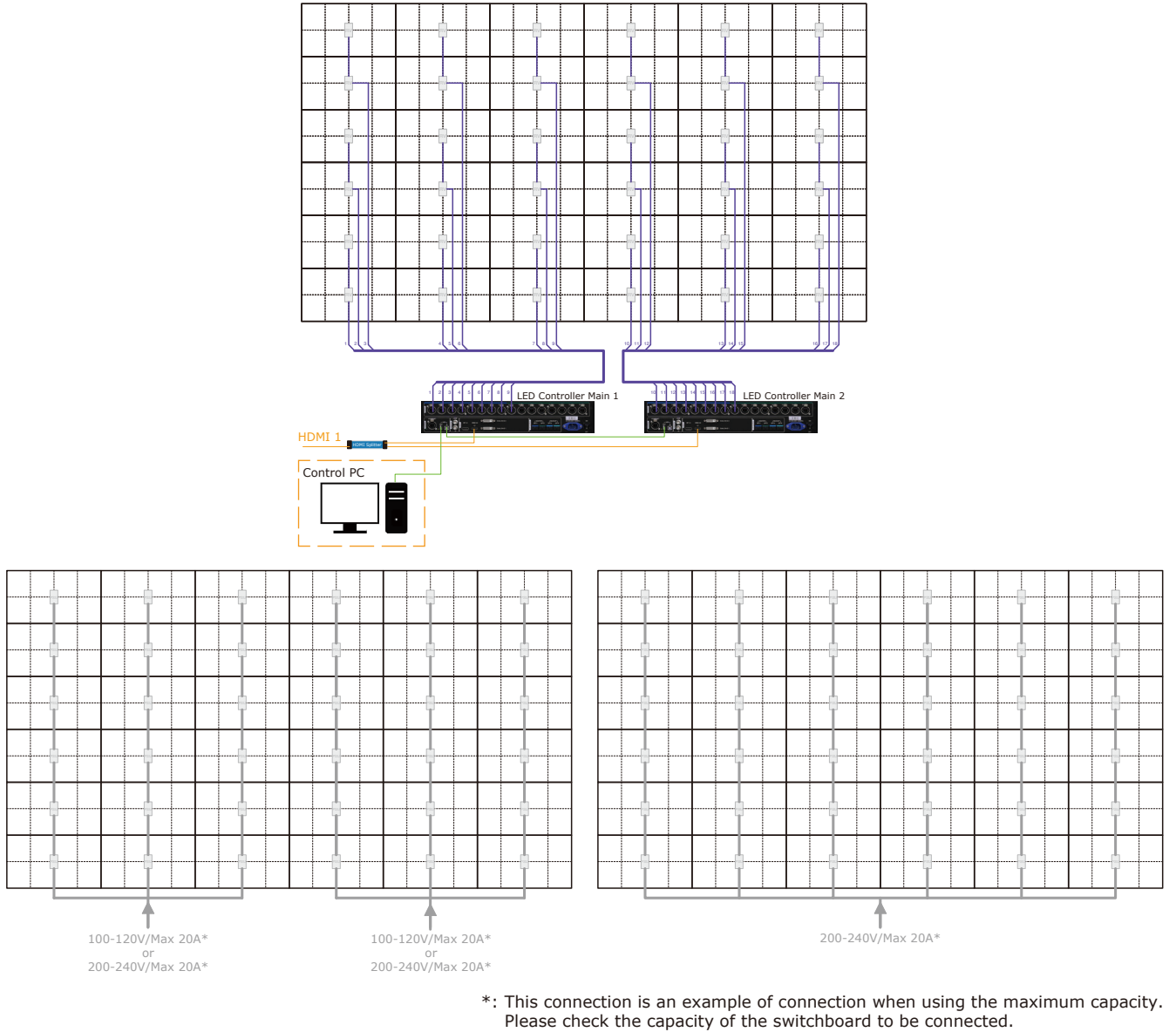

8 x 8 frame set (LED-FC012i)

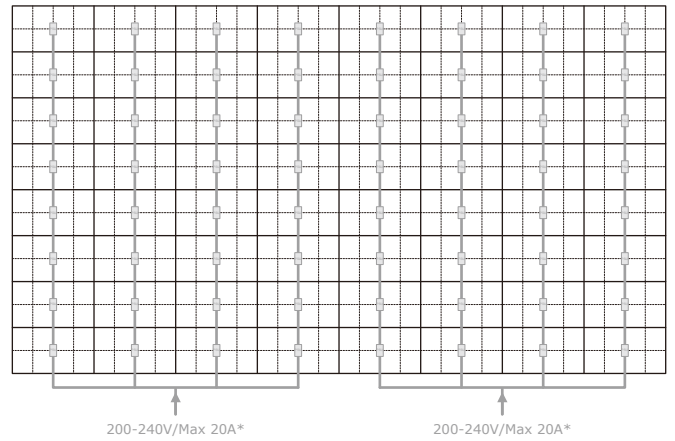
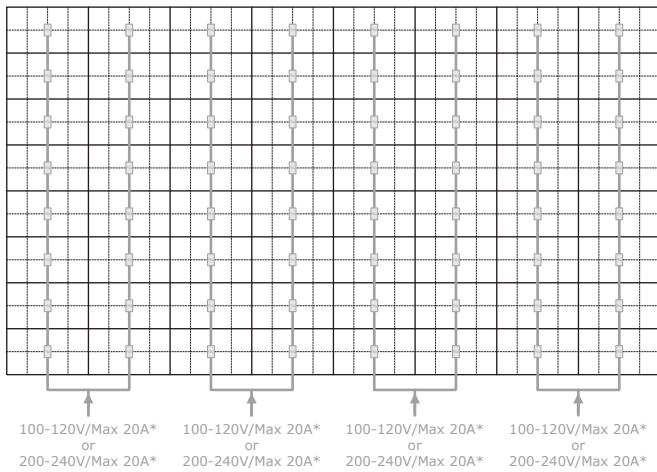
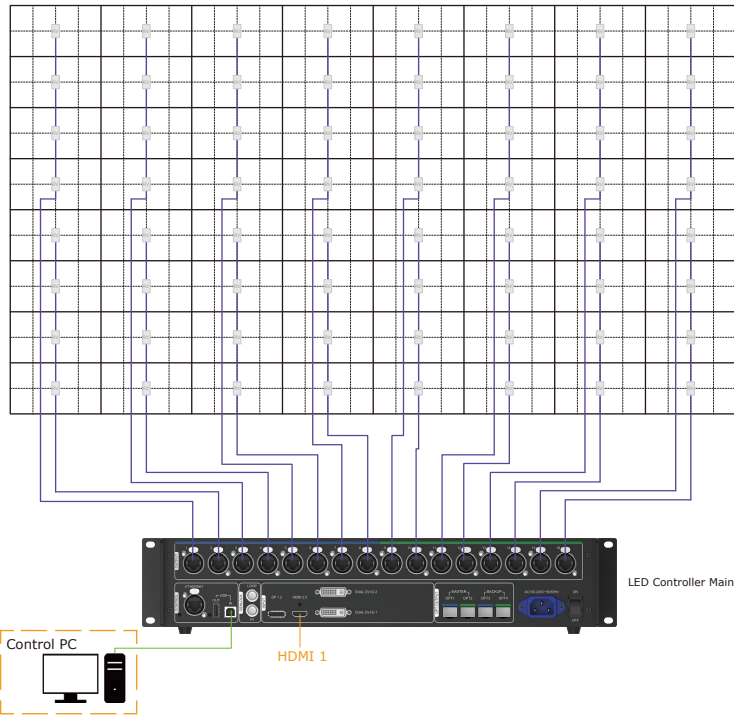

*: This connection is an example of connection when using the maximum capacity. Please check the capacity of the switchboard to be connected.

(4) Power cord connection

Connect the power cords to the LED modules on the first row.

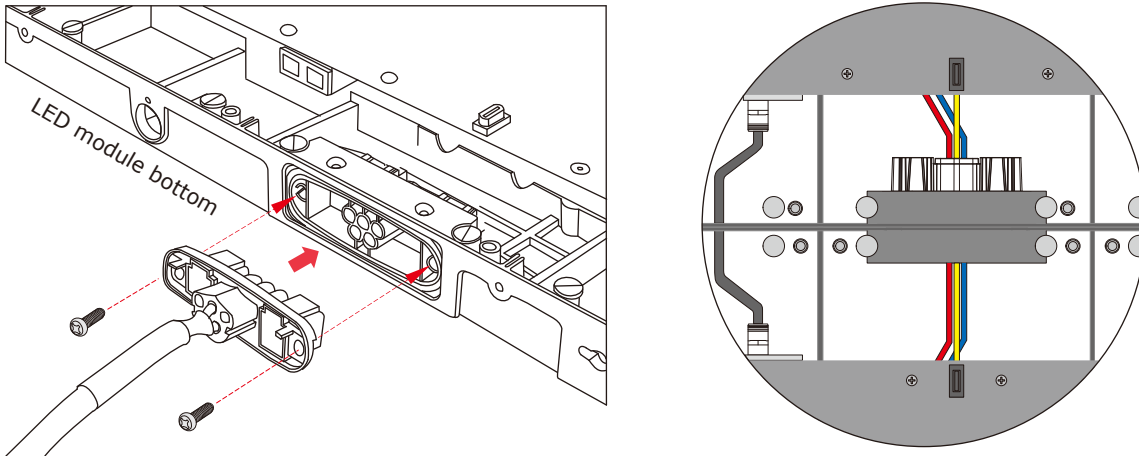

Connect the power cords between the LED modules.

⚠ CAUTION

Make sure the connector is fully and firmly inserted.

(5) LAN cable connection

Connect the LAN cables for the signal between the LED modules. Use the through holes to pass the cables between the modules.

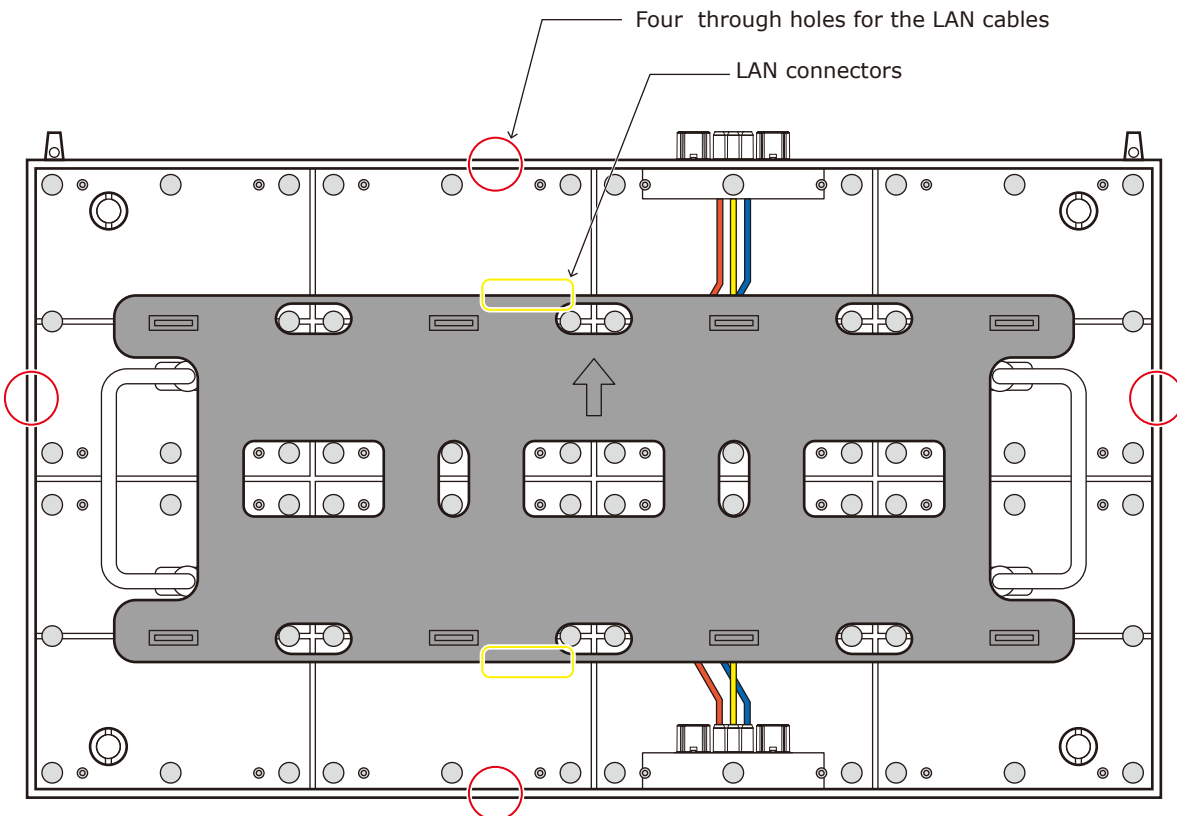

[Connection example 1] Connecting all the LED modules using a single LAN cable

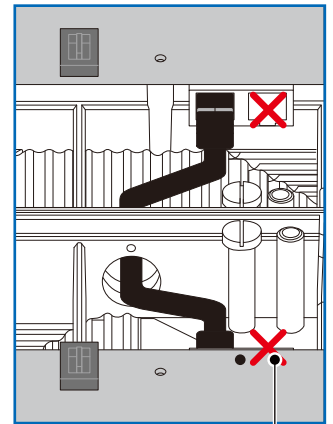
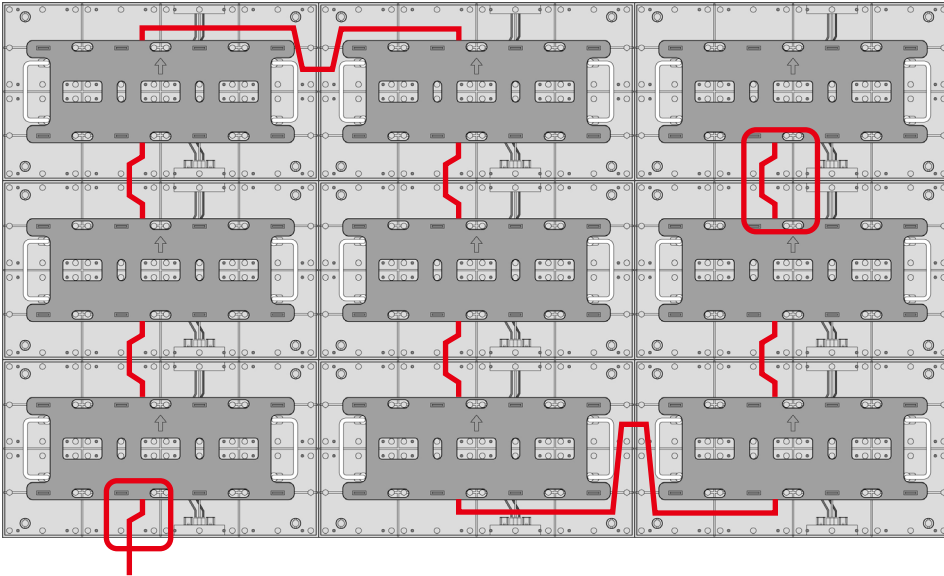

LAN cable from the LED controller

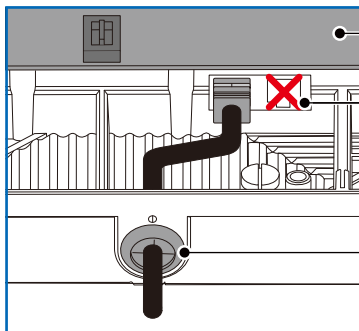

Hub board

Connect the cable to the LAN connector on the left.
Do not use the LAN connector on the right.

Insert the LAN cable into the through hole and connect it to the LAN connector on the left.

[Connection example 2] Connecting from bottom to top using multiple ports

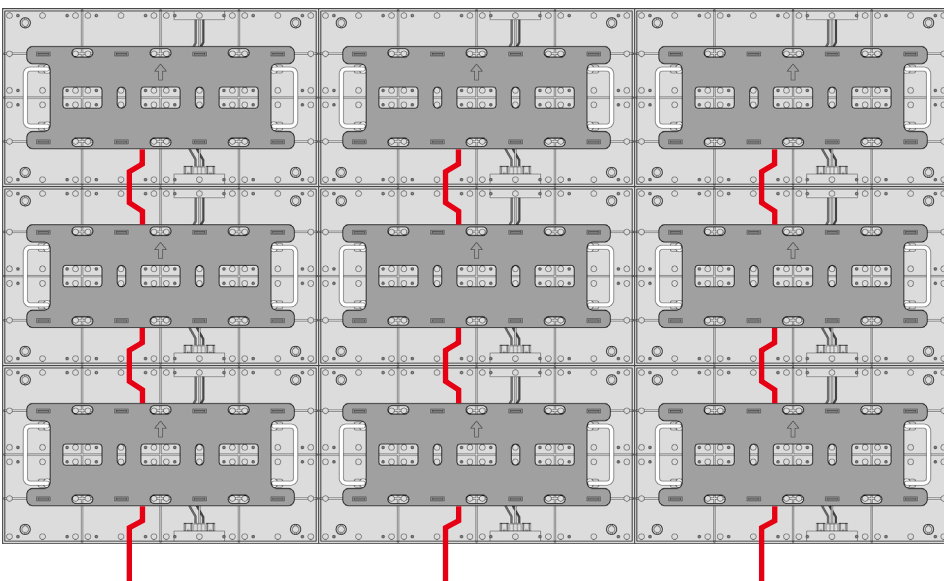

6. Installing the pixel card

CAUTION

- The pixel cards contain powerful magnets. If magnetic cards come close to the pixel cards, the data contained within may be damaged. Therefore, do not carry any magnetic card when installing the pixel cards.
- When installing the pixel cards, pay attention not to damage them against the pixel cards already installed or other objects. Otherwise, the video may not be displayed properly.
- Take measures against static electricity when installing the pixel card. Do not touch the LED display areas and the back of the pixel card.
- Check that the power supply to the LED modules is cut before starting the work.

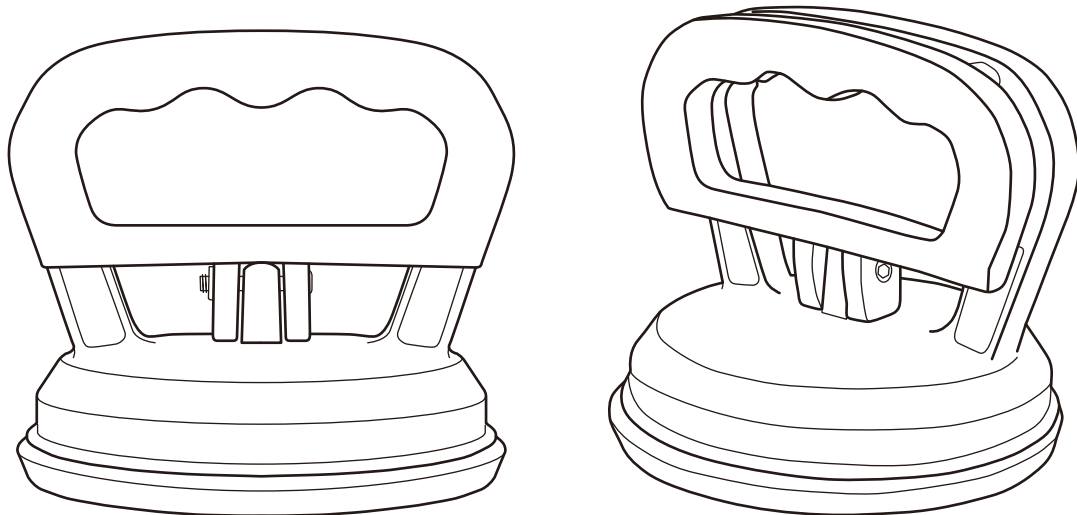

- (1) Open the grips of maintenance tool and push the maintenance tool against the pixel card. Close the grips of maintenance tool.
- (2) Install the pixel card to the cabinet paying attention that the arrows on the back of the pixel card and on the hub board are orientated toward the same direction, and that the four guide pins of the pixel card are aligned to the guide holes of the cabinet (four for each pixel card). The pixel card is secured by the 8 magnets on each cabinet.

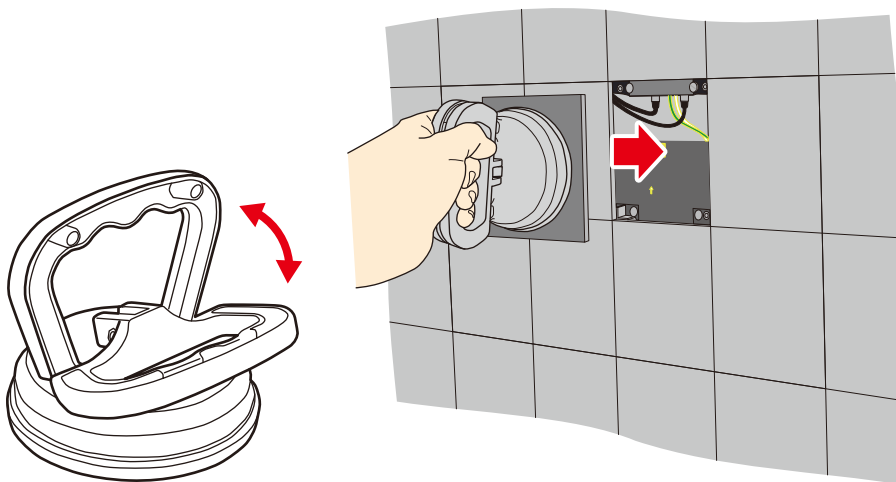

⚠ CAUTION

The pixel cards contain powerful magnets. If magnetic cards come close to the pixel cards, the data contained within may be damaged. Therefore, do not carry any magnetic card when installing the pixel cards.

The arrows (↑) at the back of the pixel cards indicate the upper side.

Install the pixel card into the cabinet with the four guide holes of the pixel card aligned with the four guide pins of the cabinet (four pins for each pixel card). The pixel card is secured by the 8 magnets on each cabinet.

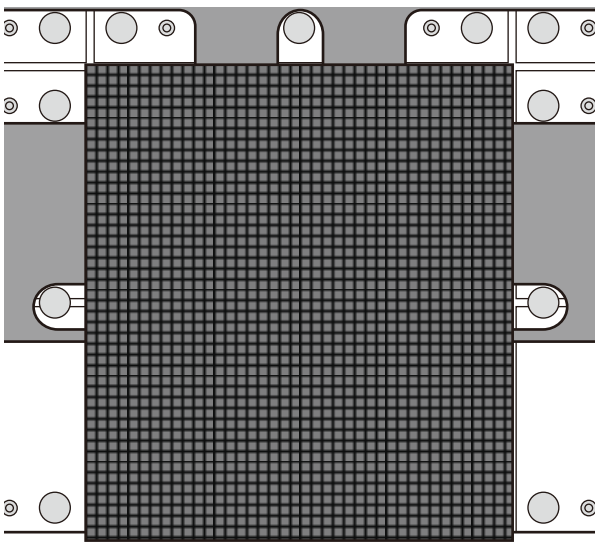
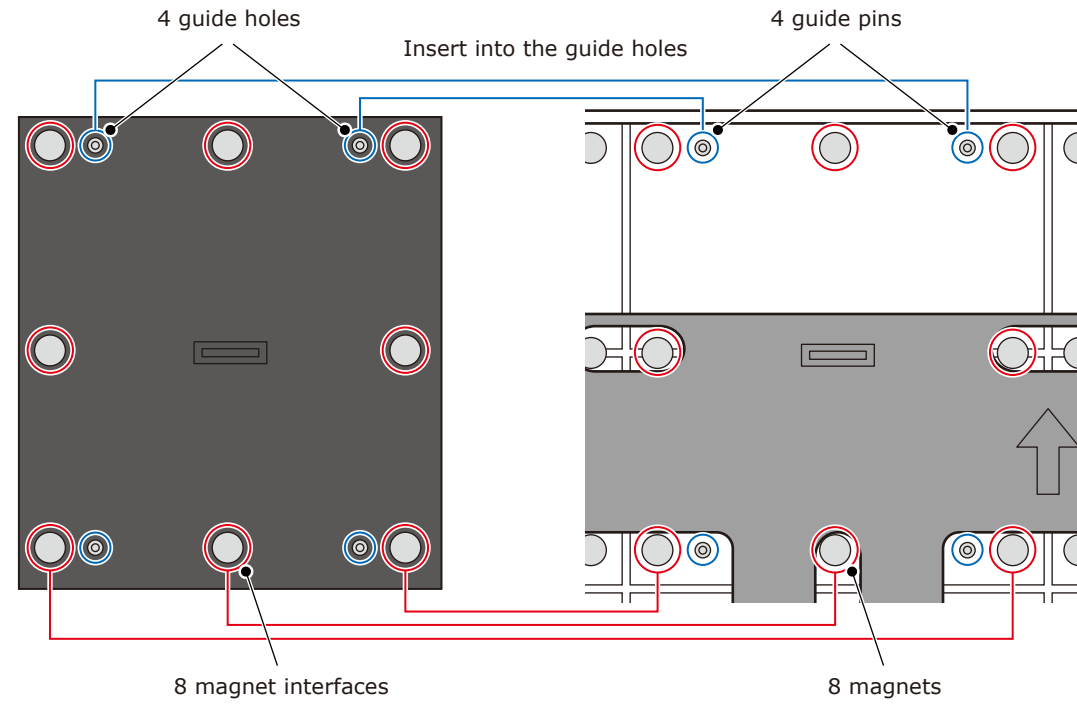

Screen Configuration

Check that all the connections are completed, and then turn on the LED modules and the LED controller.

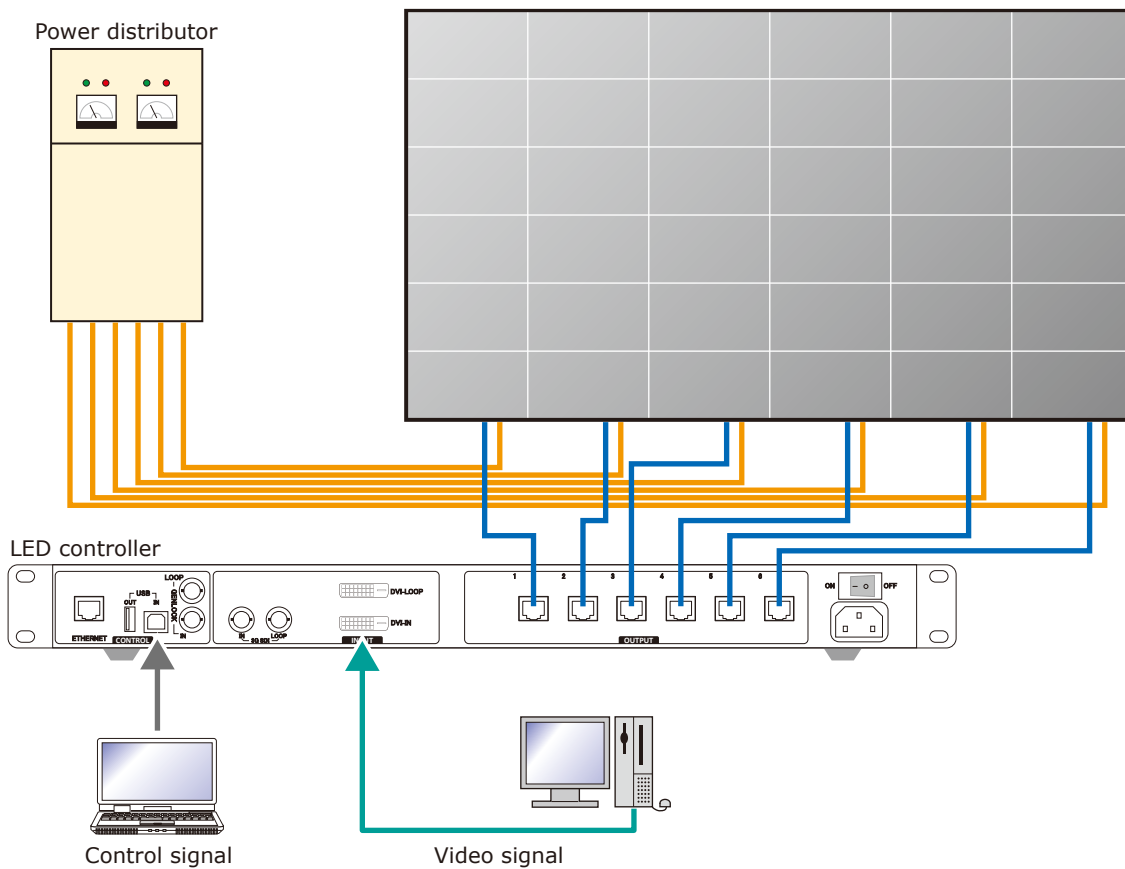

⚠ WARNING

Pay attention to the wire colors of the power cord when connecting the cord. If the cables are not connected correctly, it may lead to a fire or an electrical shock.

- Blue (N)
- Brown (L)
- Yellow green (Ground)

⚠ CAUTION

When using LAN cables of 60 m to 100 m in length, the product may not operate correctly depending on the quality of the cables. In such a case, it is recommended to use optical-fiber cables. Ask a technician or your retailer for more details.

Setting the screen configuration

Perform the setting using the LCT-Mars control software by Novastar.

Log in with the administrator privileges.

Display the login screen as follows: User(U) → Advanced Synchronous System UserLogin(A).

Enter the password ("admin" by default) to log in with the administrator privileges.

To change the password, go to User(U) → Change Password(U) with the administrator privileges.

⚠ CAUTION

Do not forget the new password after it has been changed.

Click "Screen Configuration" (a).

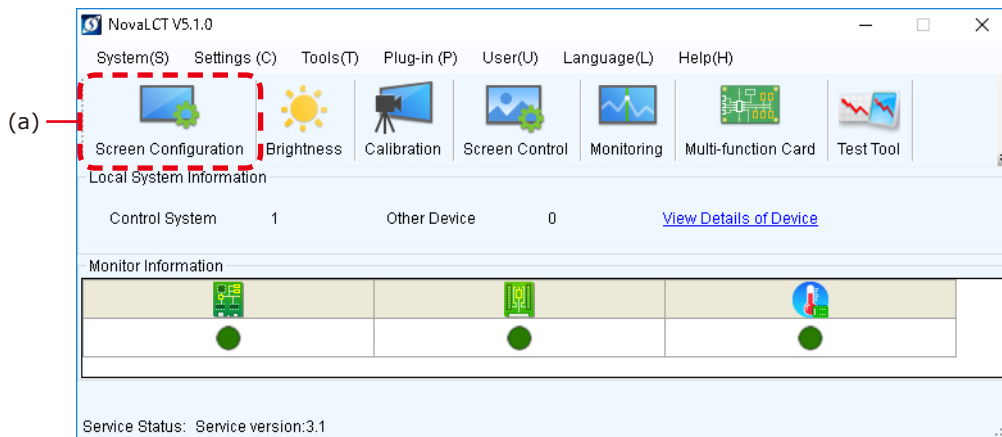

Check the port in "Select Communication Port", and then click the "Next" button (b).

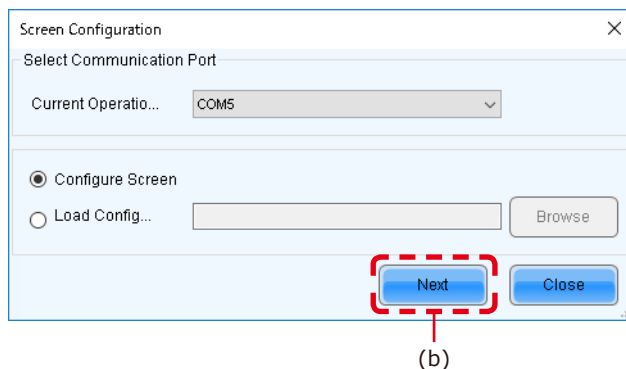

In the Screen Configuration screen that is displayed, select the "Screen Connection" tab (c).

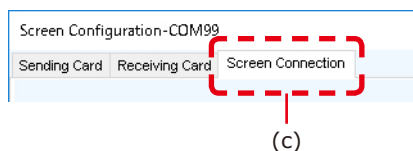

⚠ CAUTION

Do not change the settings in the "Receiving Card" tab. Otherwise, the video may not be displayed properly.

Select "Standard Screen" under "Screen Type" (d).

The settings in "Sending Card Number" (e) and "Ethernet Port No." (f) vary depending on the connected LED controller.

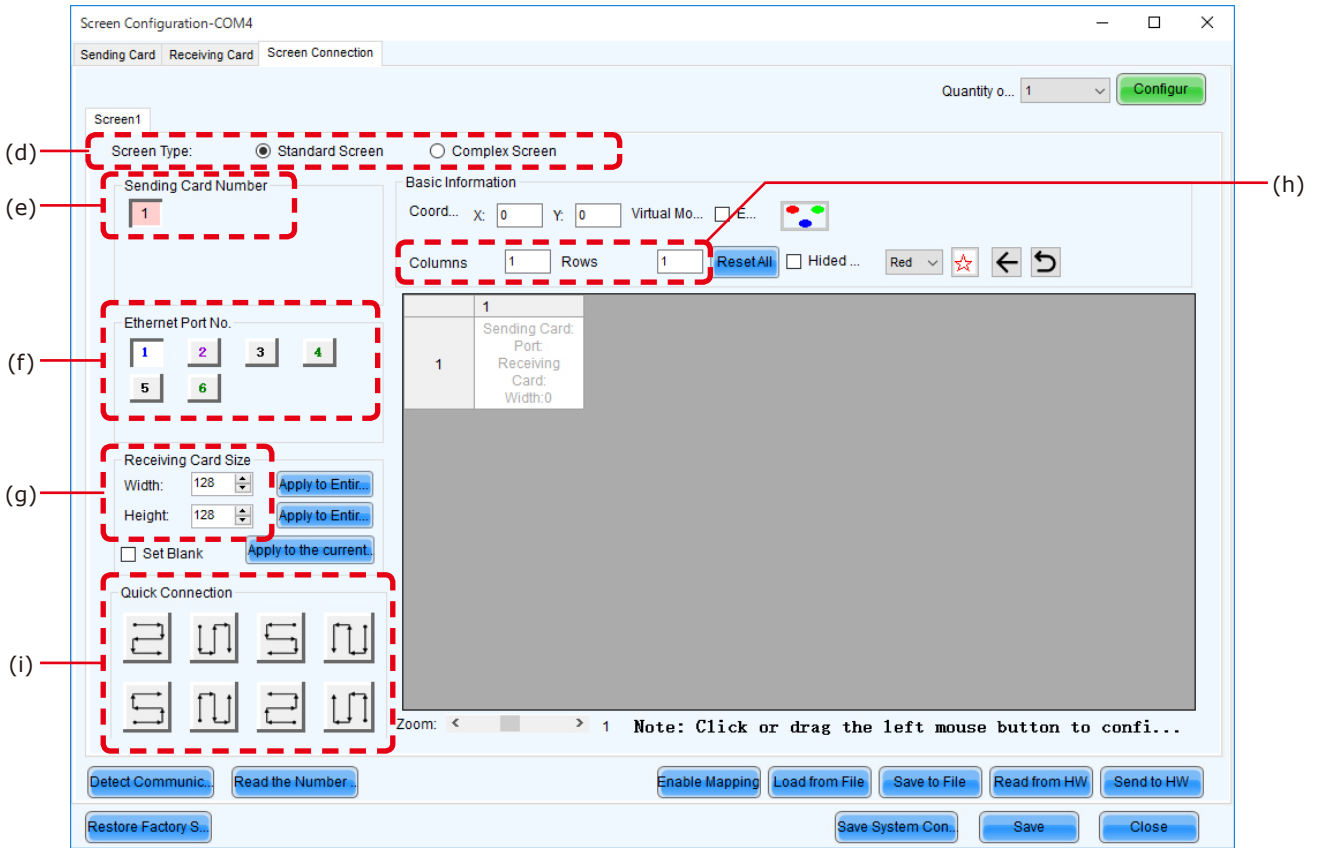

Enter the value in the table below under "Receiving Card Size" (g).

Product name	LED-FC009i	LED-FC012i	LED-FC015i
Pixel pitch	0.9 mm	1.2 mm	1.5 mm
Number of displayed pixels (resolution/module)	Width 640 Height 360	Width 480 Height 270	Width 384 Height 216

[Columns/Rows] Enter the number of installed screens under "Columns/Rows" (h) (the number of vertically installed screens in Columns, and the number of horizontally installed screens in Rows).

[Configuration example]

The setting values are given for the following example where 16 LED-E012i modules (pixel pitch of 1.25 mm) are installed in a 4 (columns) x 4 (rows) configuration.

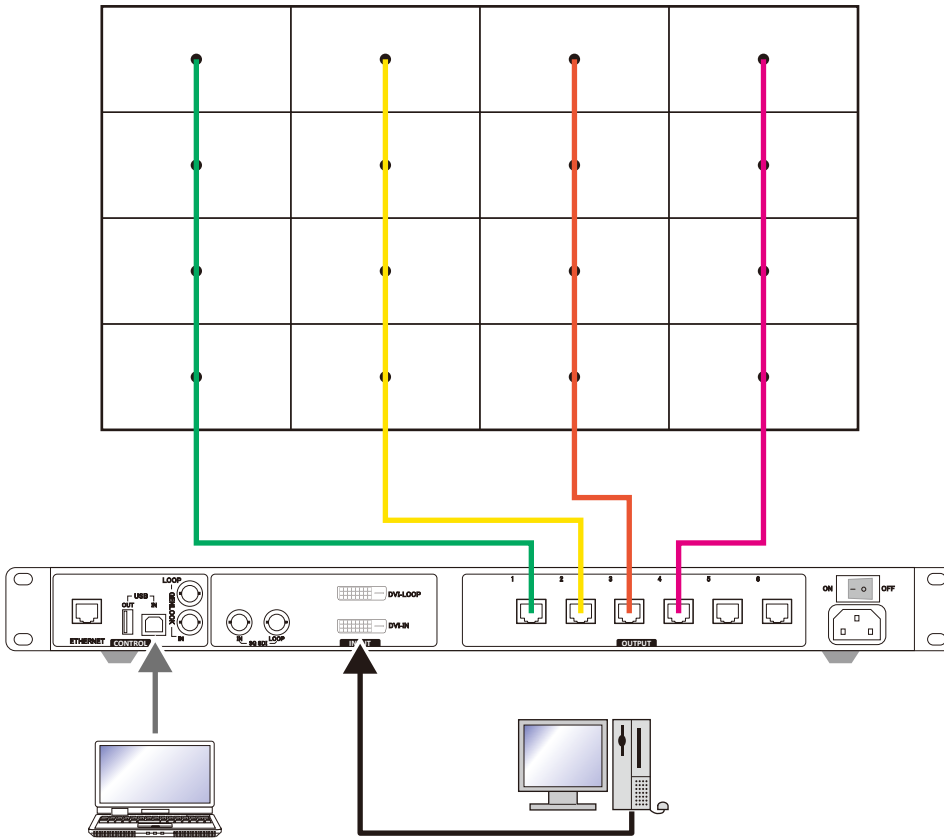

- (1) With a pixel pitch of 1.25 mm, enter Width=480 and Height=270 under "Receiver Card Size" (g). Do not use the buttons located next to the values.

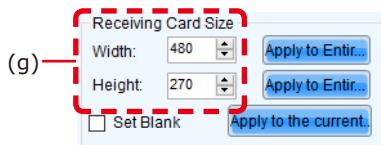

(2) Since the configuration is 4 (columns) x 4 (rows), enter Columns=4 and Rows=4. A 4 (columns) x 4 (rows) screen configuration is displayed.

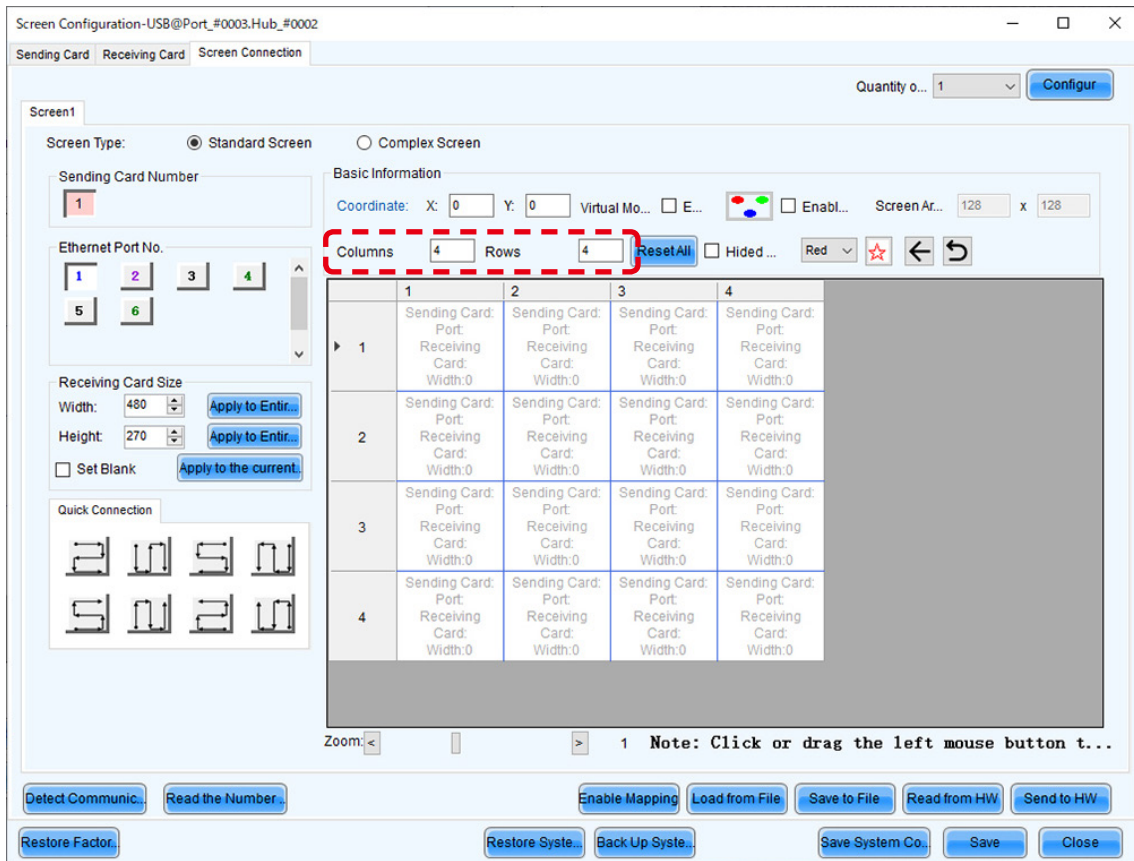

- (3) If multiple LED controllers are used, select the number of the connected LED controllers.
Since only one controller is used in this example, it is not necessary to set "Sending Card Number" (e).
- (4) Configure the connection.

(4)-1 Connecting from bottom to top using multiple ports
The system is connected to port 1 of the LED controller.

Select "1" (port 1) under "Ethernet Port No." (f).

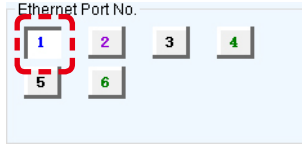

Select the cabinet at the bottom left with the mouse, and then select the other cabinets up to the top cabinet.

Then select Port2 and select the cabinets from the bottom to the top as you did for Port1.

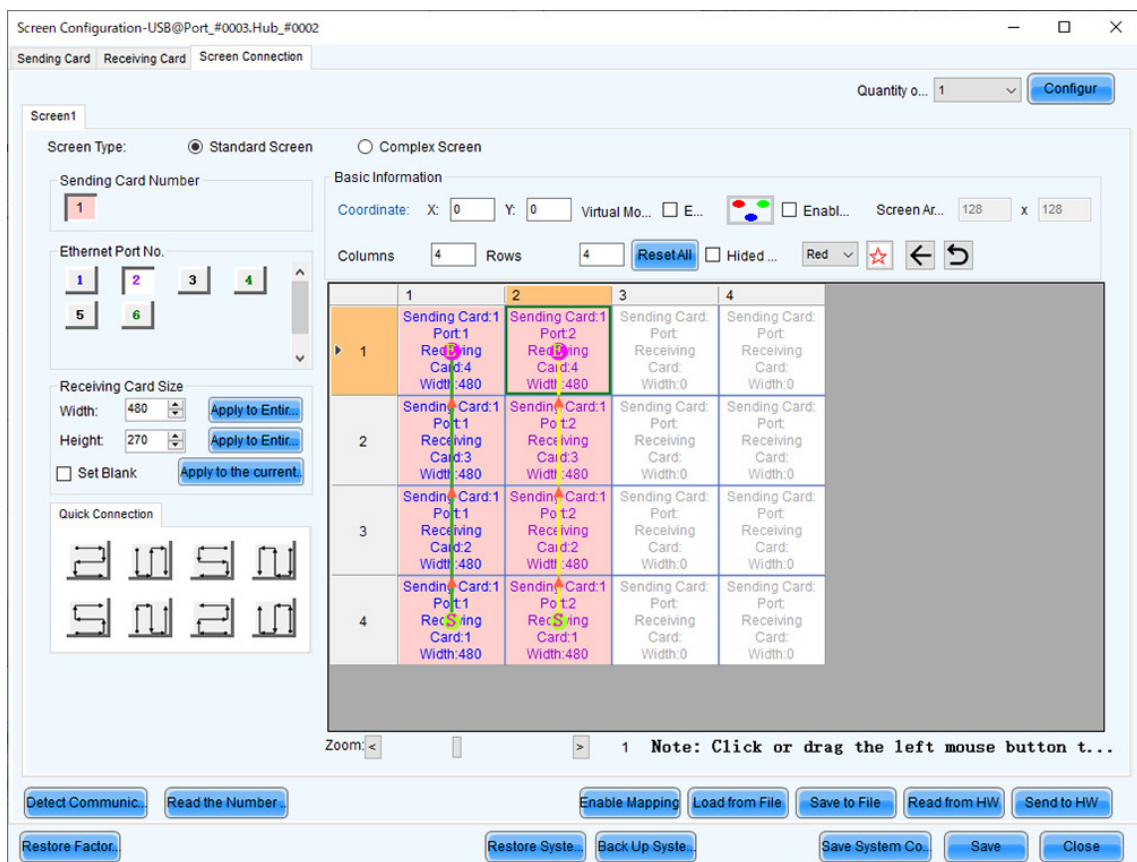

Follow the same procedure for Port3 and Port4.

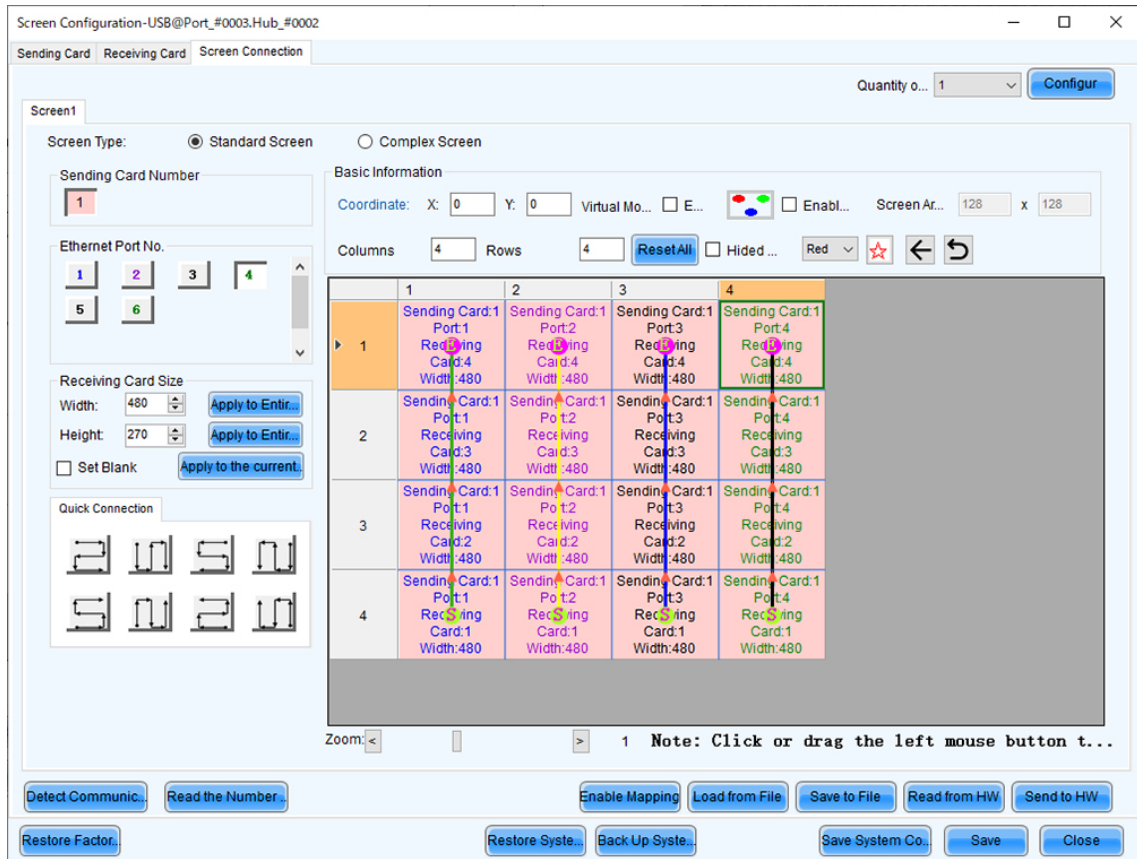

(4)-2 Connecting all the LED modules using a single LAN cable

The system is connected to port 1 of the LED controller.

Select "1" (port 1) under "Ethernet Port No." (f).

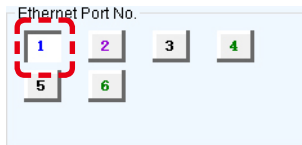

Click (select) the connection pattern under "Quick Connection" (i). Since the modules are connected from the bottom left to the top right in the example, the pattern is as shown in the figure.

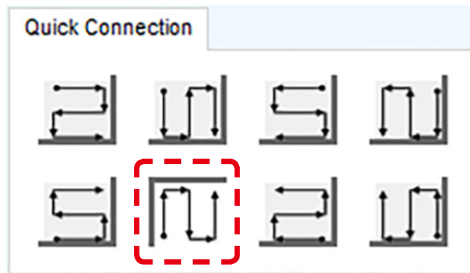

Select all the cabinets from the top left to the bottom right as shown in the figure below.

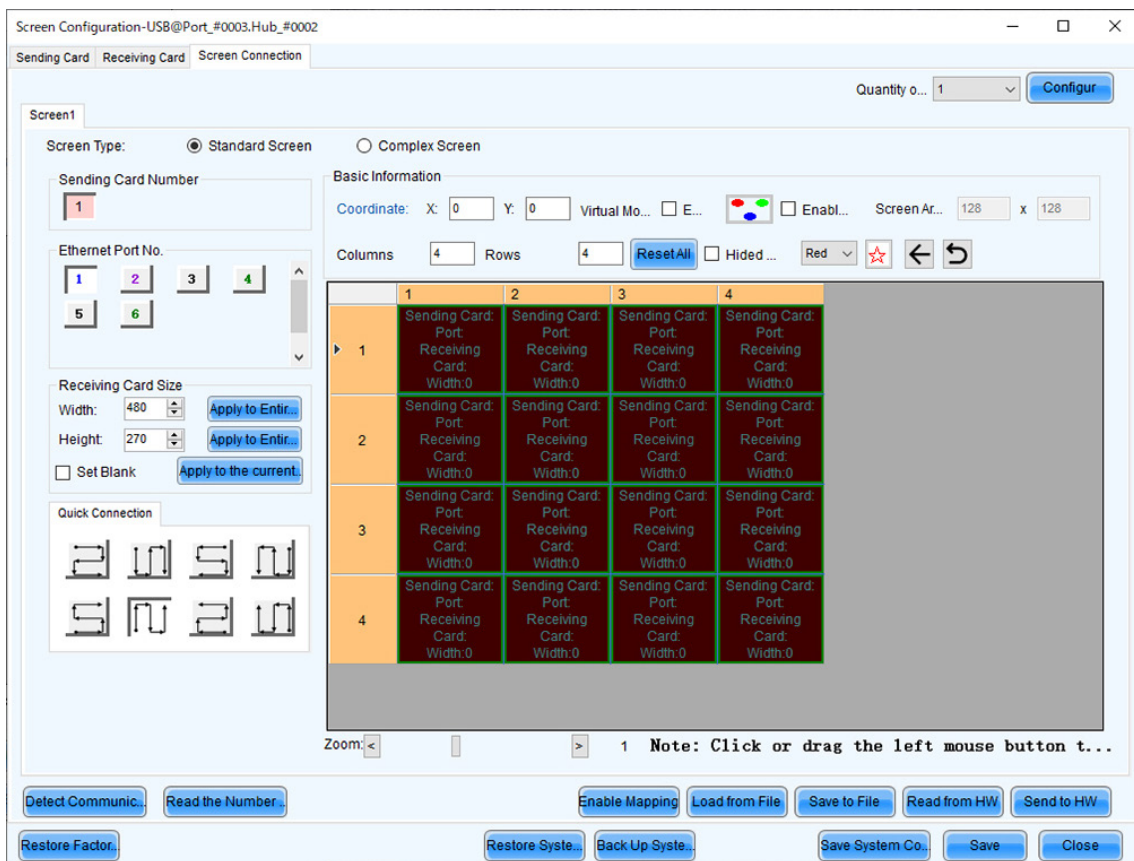

The selection is done automatically to obtain the screen below.

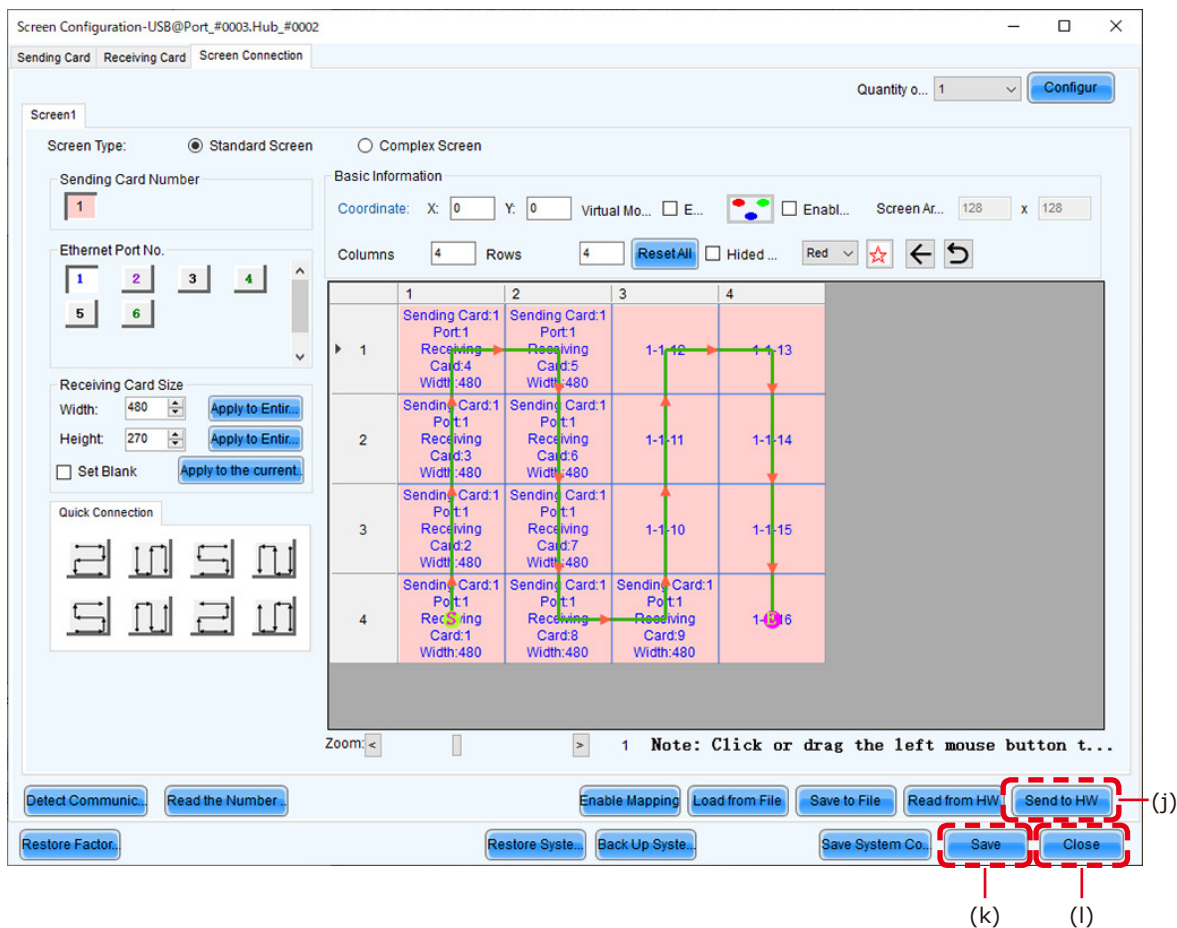

(5) Save the settings.

(a) Click the "Send to HW" button (j). When the dialog box indicating that the process finished successfully is displayed, click OK.

(b) Check that the image is correctly displayed, and then click the "Save" button (k). When the screen indicating that the process finished successfully is displayed, click OK.

The setting of the screen configuration is complete. Click the "Close" button (l) to close the Screen Configuration screen.

Image Setting

You can adjust the brightness, the gamma correction value, and the color temperature.

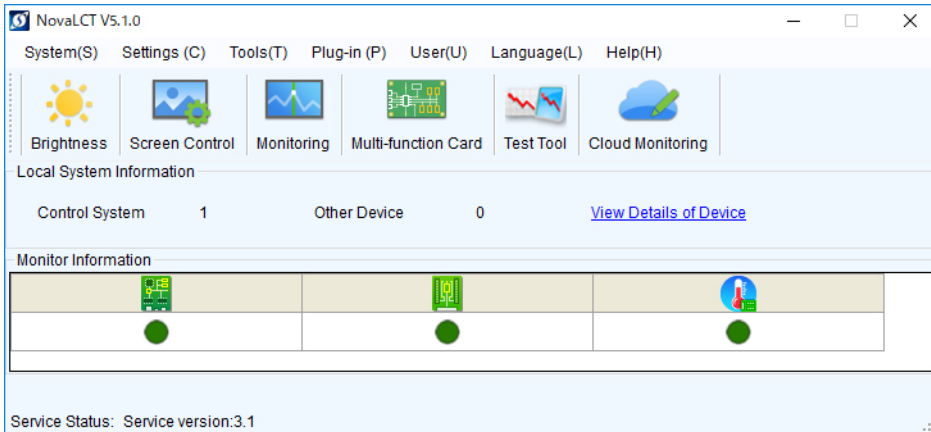

Click "Brightness" on the top screen to display the following window.

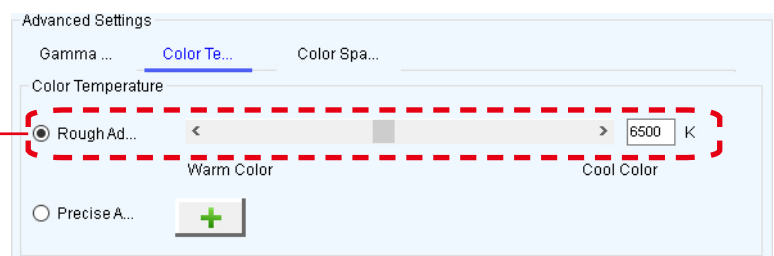
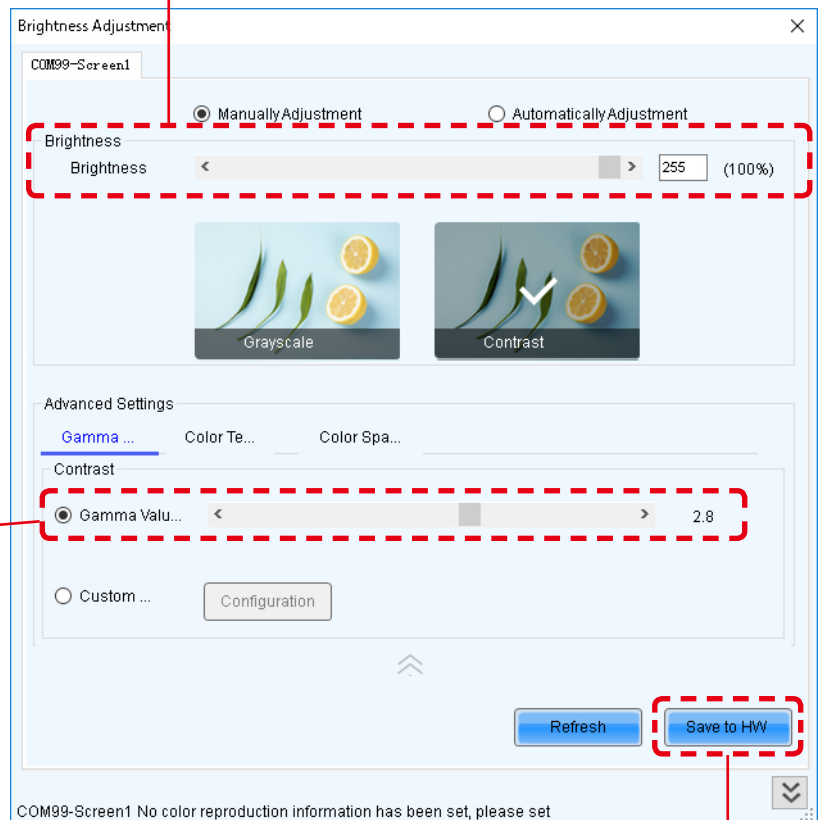
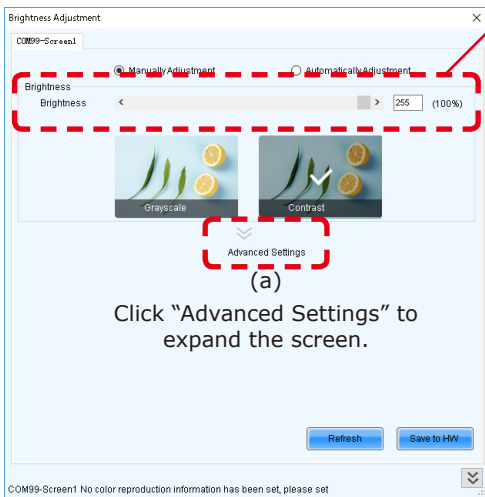

Click "Advanced Settings" (☒) (a) to expand the setting screen.

(1) Brightness

Set the brightness of the screen using the slider (b).
Increasing the value increases the brightness.

(2) Gamma correction

Set the gamma correction value using the slider (c).
Increasing the value makes the dark parts of the screen darker.

(3) Color temperature

Set the color temperature using the slider (d).
Increasing the value makes the colors more bluish, while reducing the value makes the colors more reddish.
When the setting is complete, click the "Save to HW" button to save the settings.

Cleaning

The screen brightness may decrease if dust or another foreign material is adhering to the surface of the pixel card.

The magnet used to install the pixel cards also attracts magnetic metal particles, such as iron powder.

Therefore, magnetic metal particles may adhere to areas near the magnet of the pixel card and the brightness homogeneity of the screen may decrease.

Cleaning should be performed regularly depending on the installation environment.

Required tools (example).

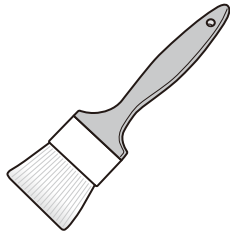

Soft brush

(animal hair brush to prevent static electricity)

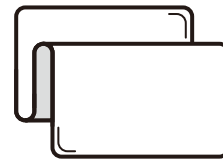

Soft cloth

(that does not generate static electricity)

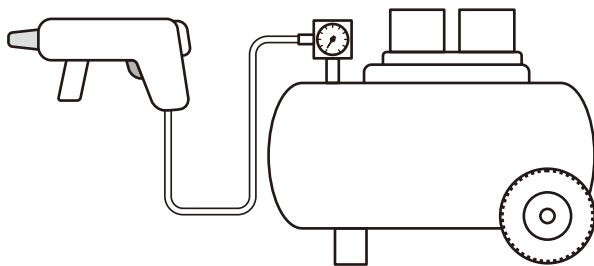

Air blower (compressor)

Cleaning method

- a) Turn the LED displays off.
- b) Use the soft brush to remove any dirt on the surface of the pixel card. If these parts are very dirty, use the air blower to remove the dirt.
- c) Use the soft cloth to remove the dirt on the screen surface.
- d) Repeat the steps (b) and (c) to remove all the dirt.

CAUTION

- Do not use water or any other liquid.
- Do not use a stiff brush.
- Pay attention not to damage the surface of the pixel card when using the soft brush, the air blower, or the soft cloth.

Maintenance

CAUTION

- Disconnect the power supply to the LED modules when performing the maintenance.
- Use the correct screwdriver for the shape of the screws when removing (loosening) or setting (tightening) the screws.
Pay attention not to drop the screws and the other parts you have removed.
Pay attention not to lose the removed screws since they will be reused.

Removing a pixel card

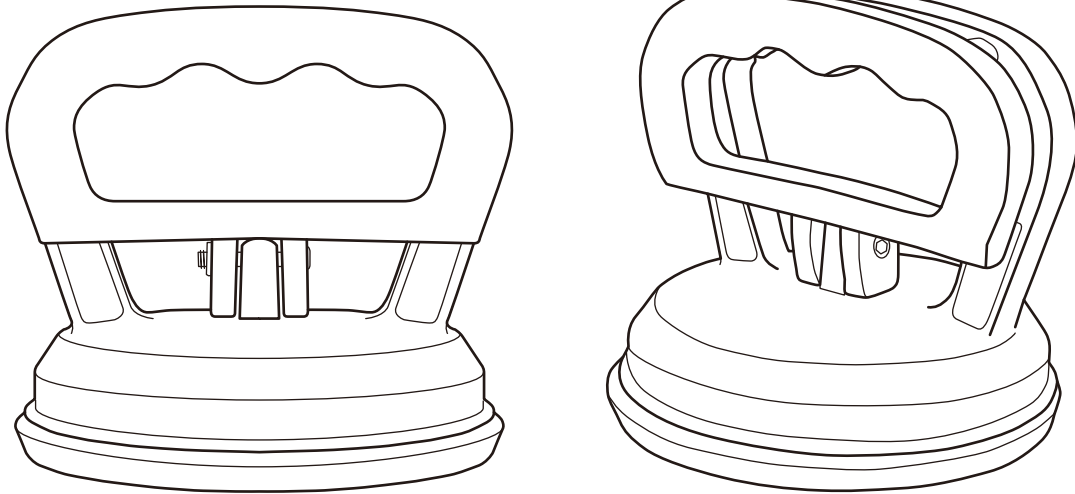

CAUTION:

Lightly hold the pixel card with your hand to prevent it from falling.

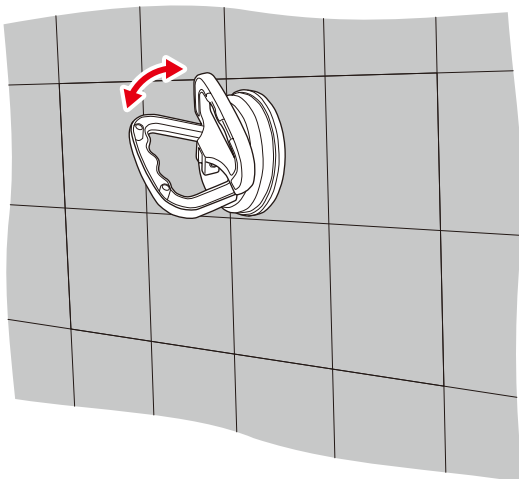

(1) Open the grips of the maintenance tool and push the maintenance tool against the pixel card. Close the grips of the maintenance tool and stick the pixel card.

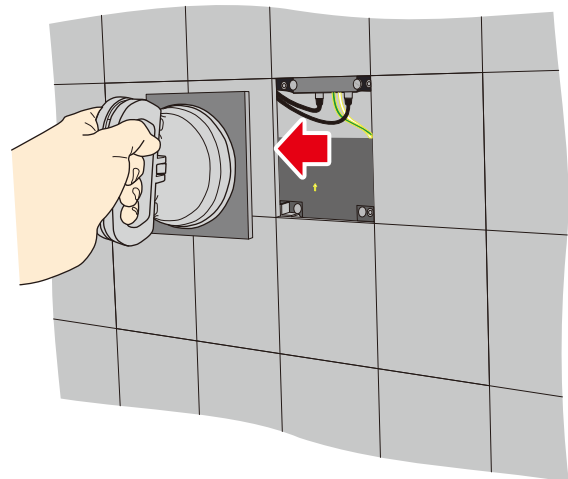

(2) Pull it straight toward you to remove the pixel card.

Removing and installing the hub board

- (1) Removing the hub board
 - (a) Disconnect the LAN cable from the hub board
 - (b) Remove the 16 screws securing the hub board with a Phillips screwdriver (No. 1).
 - (c) Since the hub board is connected to the power unit with pins and connectors, remove it by raising this part, as well as the part with the positioning holes. The status board and the hub board are connected with a cable. Pay attention not to pull the hub board.
 - (d) Disconnect the cable from the hub board, and then remove the hub board.

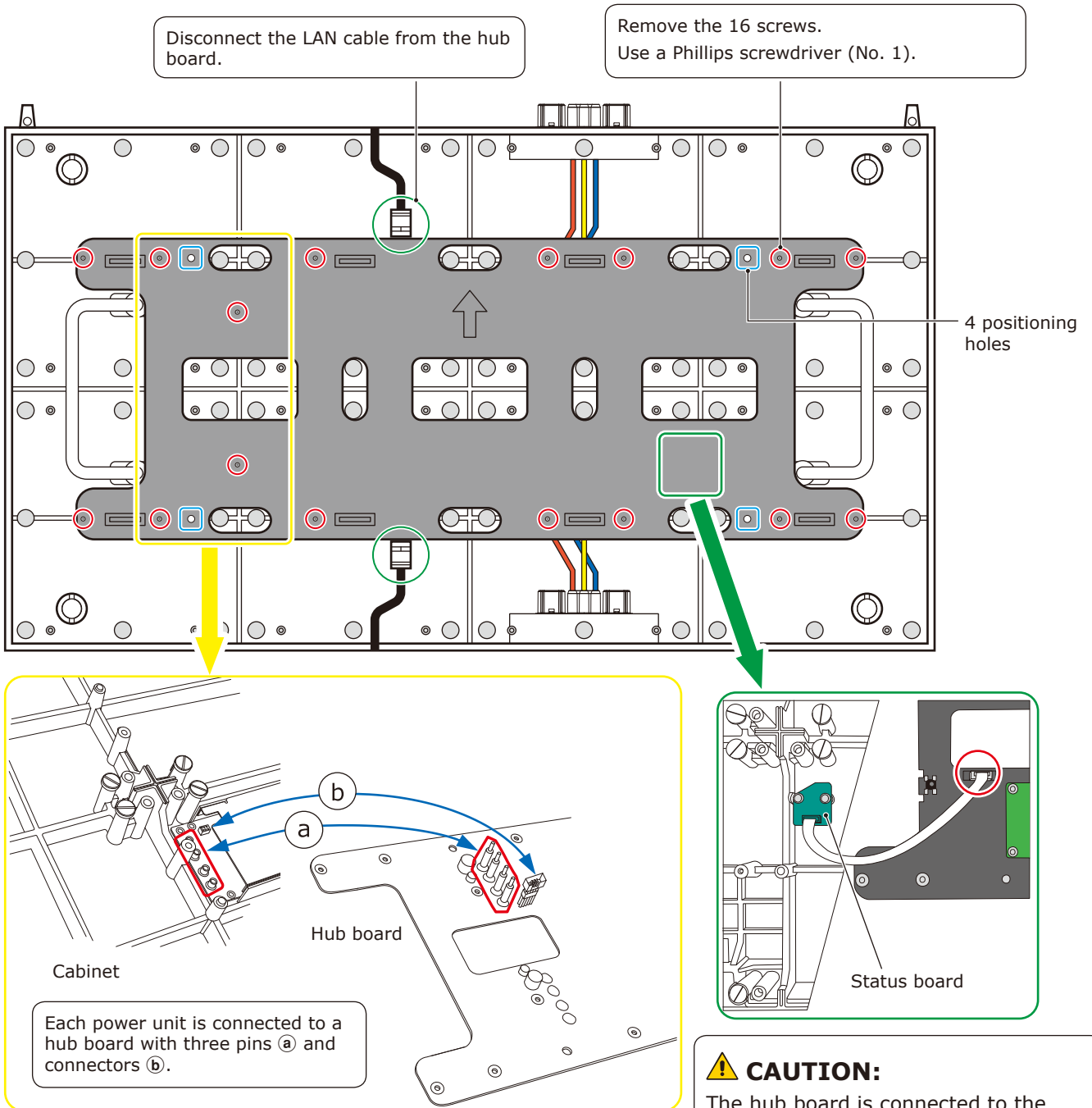

(2) Installing the hub board

Install the hub board into the cabinet following the procedure below.

- (a) Connect the status board to the hub board using the cable.
- (b) Install the hub board into the cabinet. Install it with the power unit pins and connectors aligned. Insert the pins and connectors completely and check that the hub board is securely attached and not bent.
- (c) Tighten the 16 screws. Use a tightening torque of $3 \pm 0.5 \text{ kgf}\cdot\text{cm}$.
- (d) Connect the LAN cable.

Replacing the power unit

The power unit dissipates heat through the cabinet. Apply some thermal paste on the back of the power unit to be replaced. Ask your retailer for more details on the types of thermal paste.

- (a) Remove the hub board following the "(1) Removing the hub board" procedure on the previous page.
- (b) Remove the four screws, and then remove the power hub board.
- (c) Remove the two magnets and the two screws securing the power unit, and then replace the power unit.
- (d) Install the power hub board, the protective sheet, and the hub board.
- (e) Install the hub board following the "(2) Installing the hub board" procedure on the previous page.

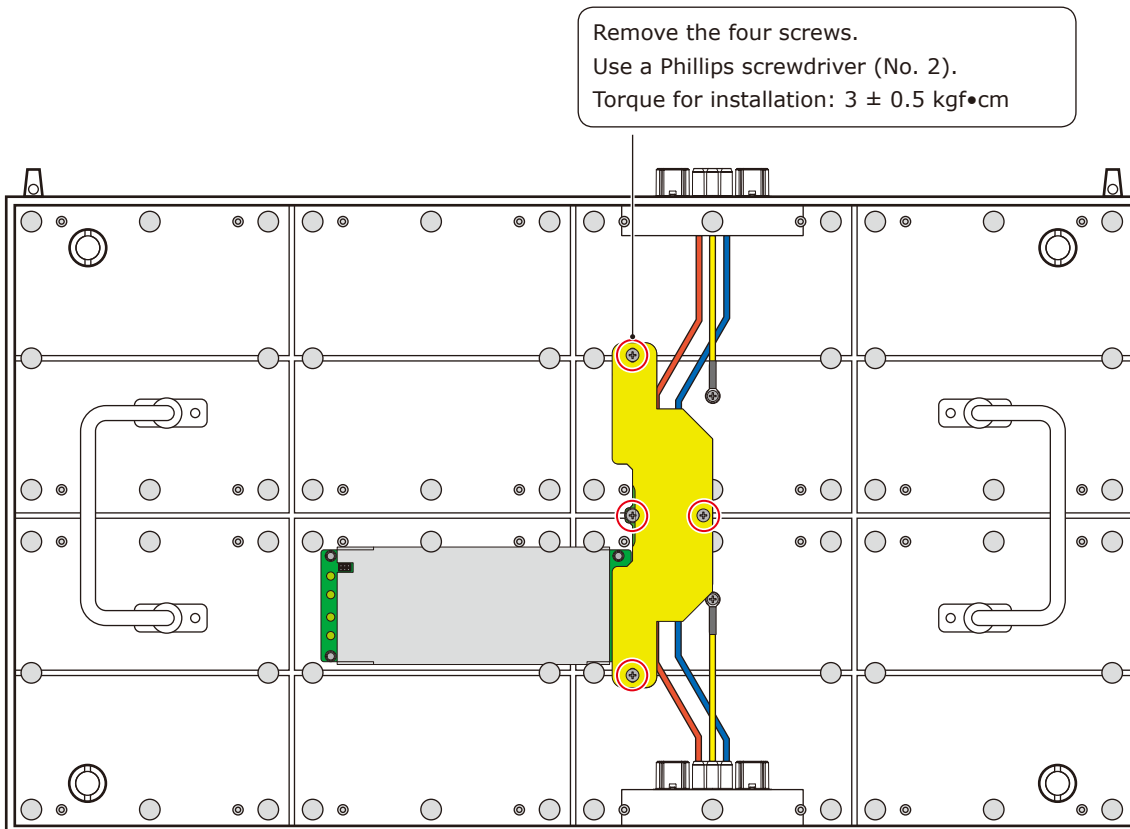

Remove the two screws securing the power unit.
Use a Phillips screwdriver (No. 2).

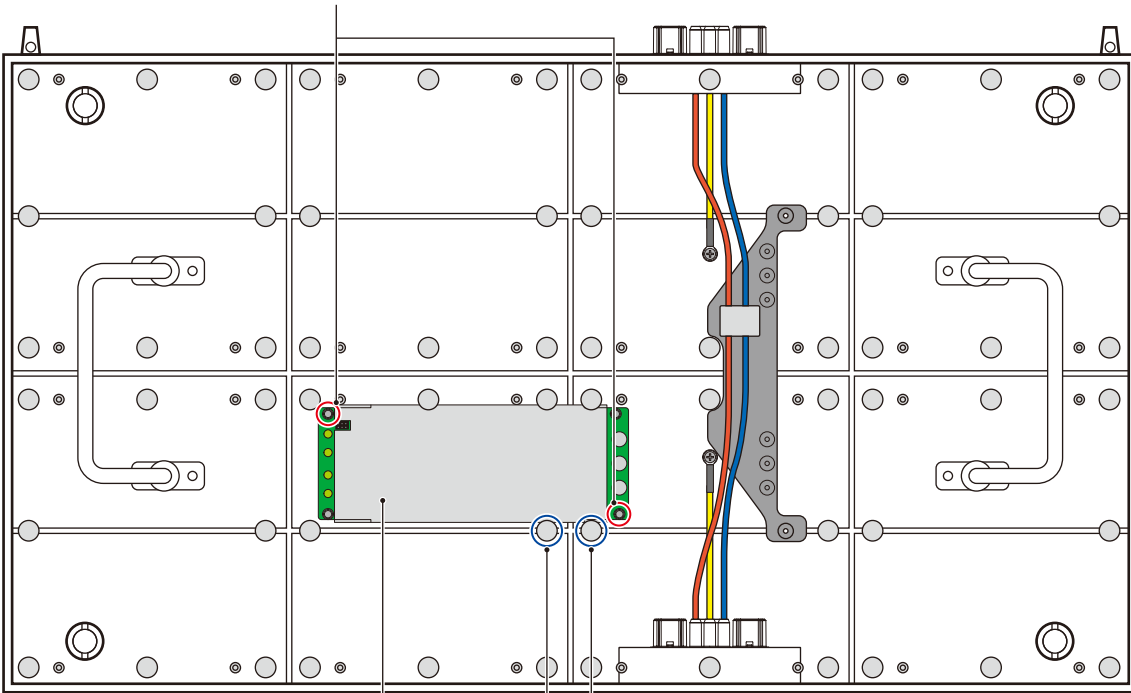

Use a pair of pliers to hold the two magnets, rotate them, and remove them.

Replace the power unit.
Use the screws you have removed to secure the power unit.
Tightening torque: $3 \pm 0.5 \text{ kgf}\cdot\text{cm}$

Replacing the receiving card

The receiving card is fixed to the hub board with two board-to-board connectors.

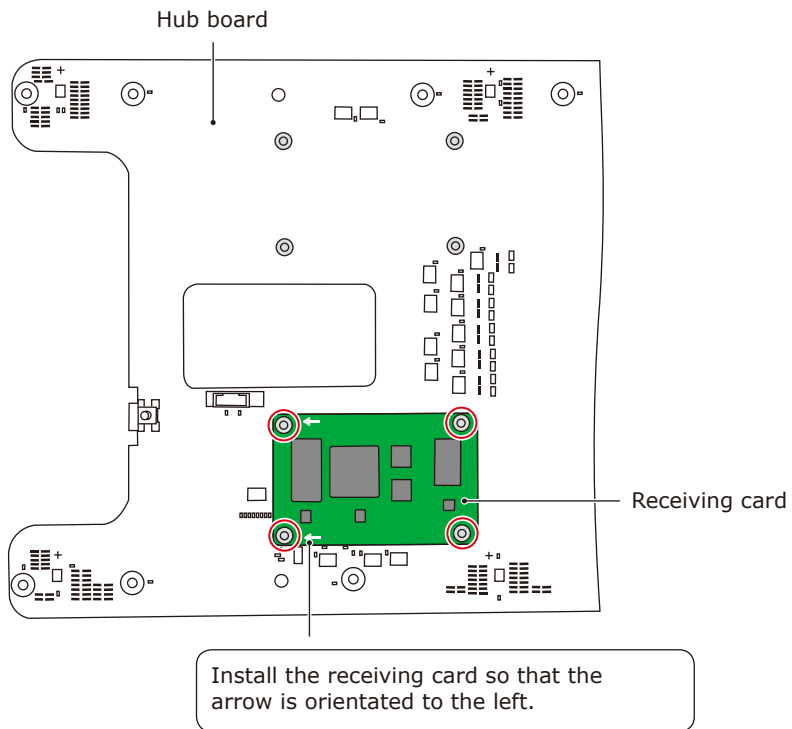

Troubleshooting

1. Display problems

Problem	Solution
Nothing is displayed on all the LED modules.	Check that power is being supplied to the LED modules.
	Check that the LED controller is turned on.
	Check that a video signal is being input to the LED controller.
	Check that a LAN cable is correctly connected between the LED controller and the LED module.
	Check that the brightness is not set to 0% (= not lit).
Nothing is displayed on one LED module.	Check that a LAN cable is correctly connected between the LED controller and the LED module.
	The receiving card inside the LED module may be broken. → Check the status of the LED module by following the procedure in the next section "2 State monitoring using the software".
	The power unit inside the LED module may be broken. → Check the status of the LED module by following the procedure in the next section "2 State monitoring using the software".
No image is displayed on one pixel card.	Check that the contacts of the pixel card are correct (contacts of the hub board).
	The pixel card may be broken. Replace it with a spare pixel card.
Control (communication) is not possible.	Check that the communication cable is correctly connected between the computer and the LED controller.
	Check that the LED controller is turned on.
	If the communication cable is a USB cable, check that the device driver runs correctly.

2. State monitoring using the software

In case of a problem, you will be able to determine the location where it occurred by monitoring the state of the system.

2-1 Display under normal conditions

The display is green under normal conditions.

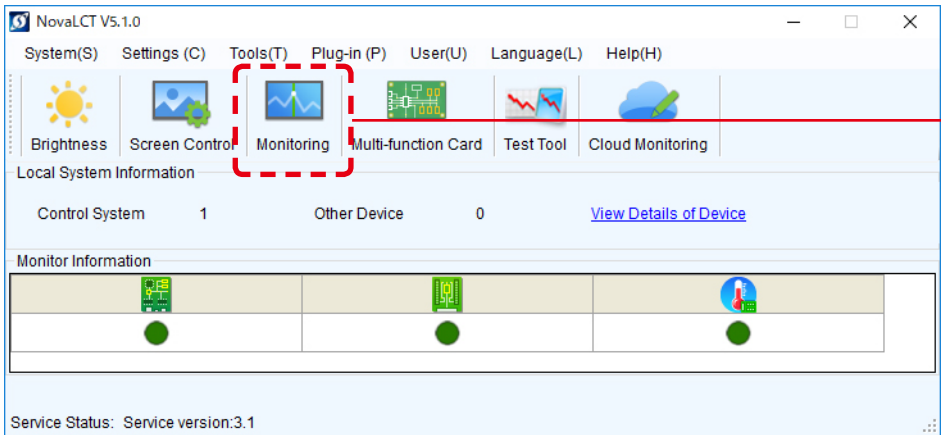

Click "Monitoring" to check

- the state of the LED controller
- the operating state of the LED modules
- the temperature of the LED modules

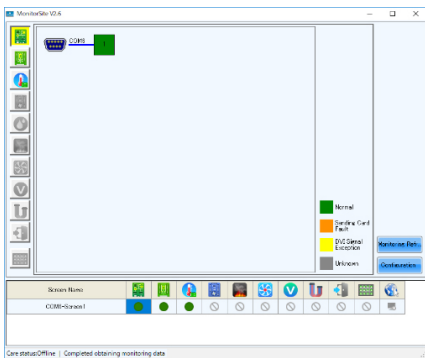

State of the LED controller

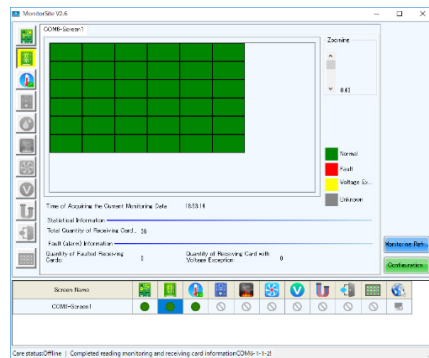

State of the LED modules

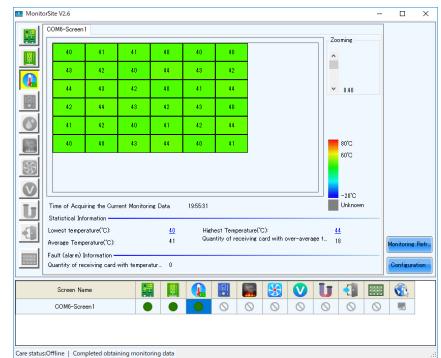

Temperature of the LED modules

2-2 Display under abnormal conditions

(1) Problem with the input signal to the LED controller

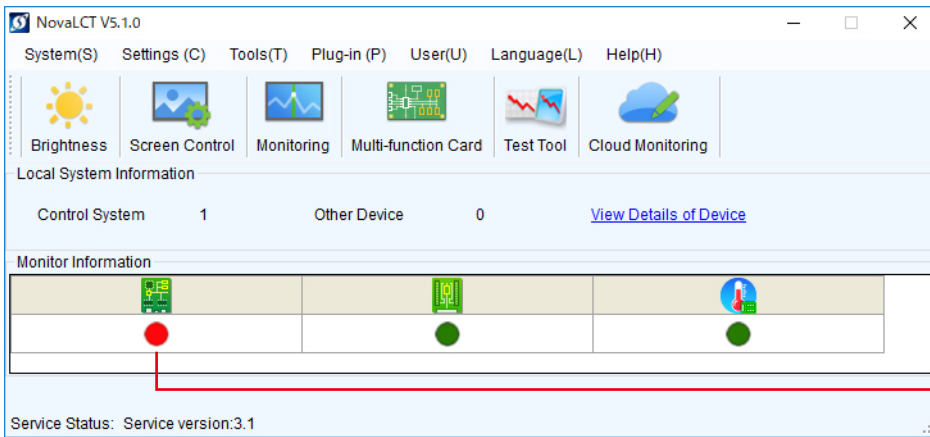

When the display is red, there is a problem with the LED controller.

To display more details, click "Monitoring", and then click "Sending card" on the screen that is displayed.

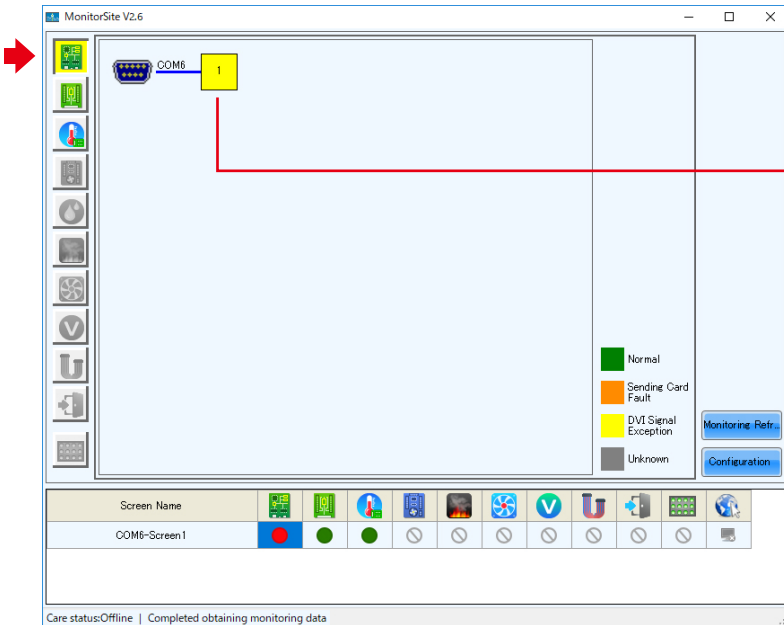

No video signal is being input to the LED controller.

- Check that the LAN cable is connected.
- Check that a video signal is being output from the video output equipment.
- If multiple signals are being input to the LED controller, check the input settings of the LED controller.

(2) Problem with the LED modules

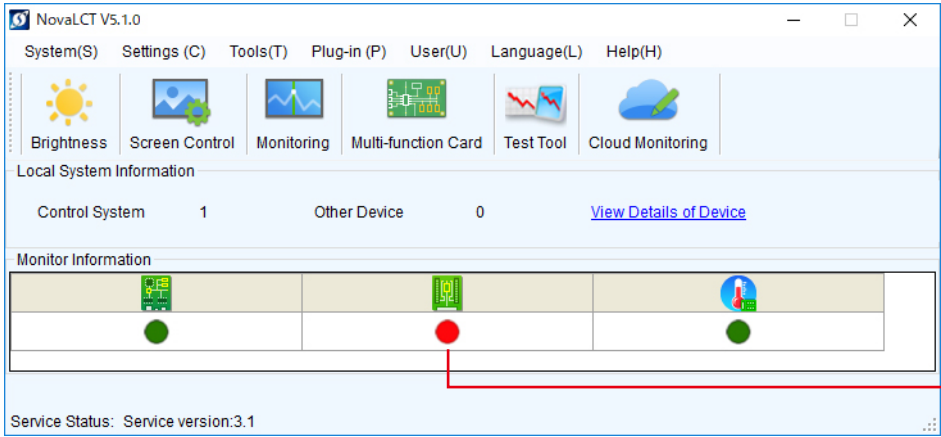

When the display is red, there is a problem with the LED module operation.

To display more details, click "Monitoring", and then click "Receiving card" on the screen that is displayed.

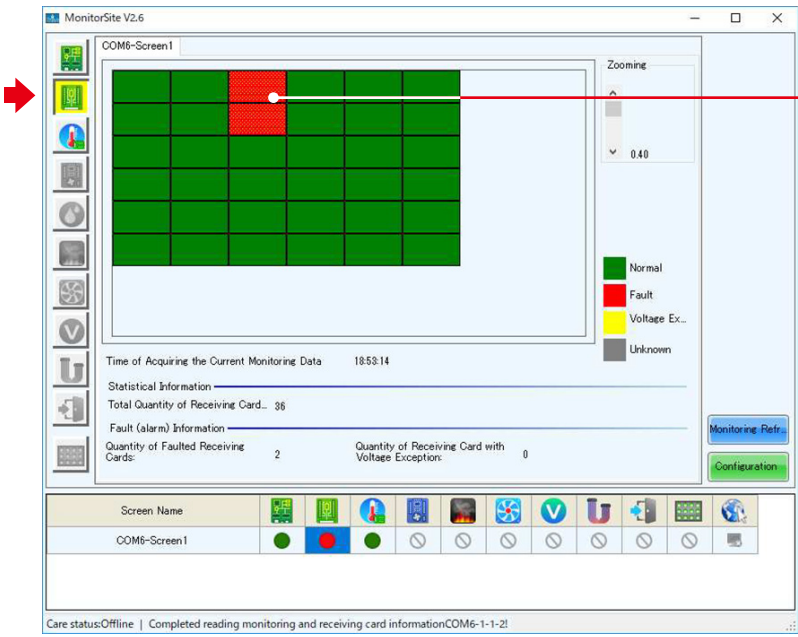

In the example shown on the left, the following problems must be considered.

- Signal loss between the screen of the 3rd row 3rd column and the screen of the 2nd row 3rd column
 - Check the internal LAN cable.
- Problem with both power units of the screen of the 2nd row 3rd column
 - Check the rear indicator (green) to see if it is lit.

There is no problem if it is lit green.

- Problem with the receiving card of the screen of the 2nd row 3rd column
 - Check that the receiving card is securely connected. If there are no connection problems, the receiving card may malfunction. (Replacing the receiving card)

(3) Problem with the internal temperature of the LED modules

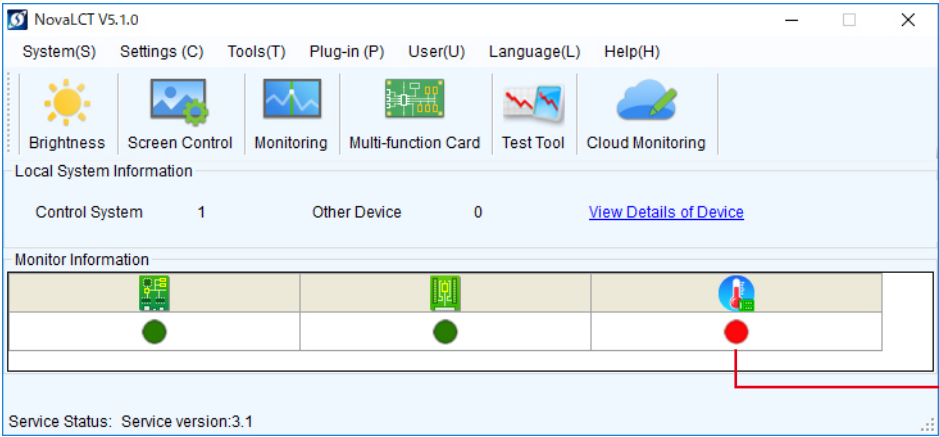

There is a problem with the LED module operation.

To display more details, click "Monitoring", and then click "Temperature" on the screen that is displayed.

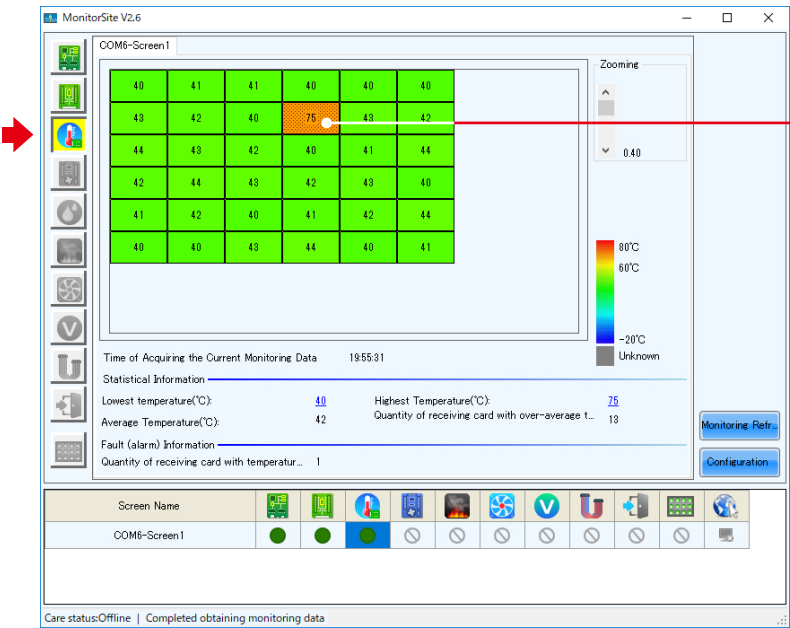

The LED modules with a high temperature are displayed in warm colors.
 Since the internal temperature is high, decrease the brightness setting.
 If changing the brightness setting could not solve the problem, contact your retailer or the Customer Service.

(4) Communication problem

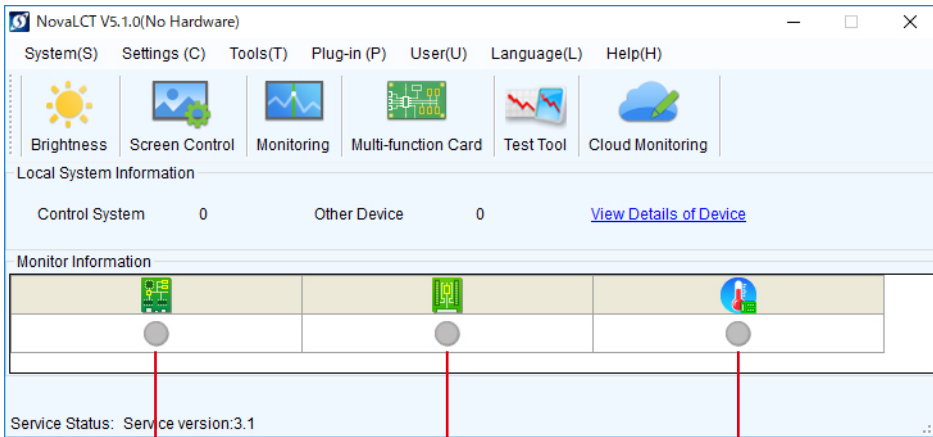

When the display is grey, the communication is not established.

- Check that the USB cable is connected.
- Check that the LED controller is turned on.

Specifications

Models for indoor use

		LED-FC009i	LED-FC012i	LED-FC015i
LED configuration		Flip chip COB (chip size : 4mil*8mil)		
Pixel pitch		0.95 mm	1.26 mm	1.583 mm
Number of displayed pixels (resolution/module)		640 × 340	480 × 270	384 × 216
Brightness		800 cd/m ²		
Contrast ratio		20000:1		
Brightness adjustment range		0 to 100% (256 increments)		
Gamma correction		1.0 to 4.0 (default setting: 2.8)		
Color temperature		3000 K to 9500 K (default setting: 6500 K)		
Viewing angle		Up 80°, Down 80°, Left 80°, Right 80°		
Signal interface	Signal input	1 × RJ-45		
	Signal output	1 × RJ-45		
Power supply		100 V AC to 240 V AC, 50 Hz/60 Hz		
Power consumption (all white, 100% brightness)		70 W		
IP rating		Front IP40 / Rear IP20		
Maintenance		Front		
Dimensions		608 × 342 × 48.5 mm		
Weight		7.0 kg		
Operating environment	Temperature	-20 to 40°C		
	Humidity	10% to 80% (without condensation)		
	Altitude	No more than 5000 m		
Storage environment	Temperature	-20 to 45°C		
	Humidity	10% to 85% (without condensation)		

Specifications are subject to change without notice.

Diagram

LED-FC009i / LED-FC012i / LED-FC015i

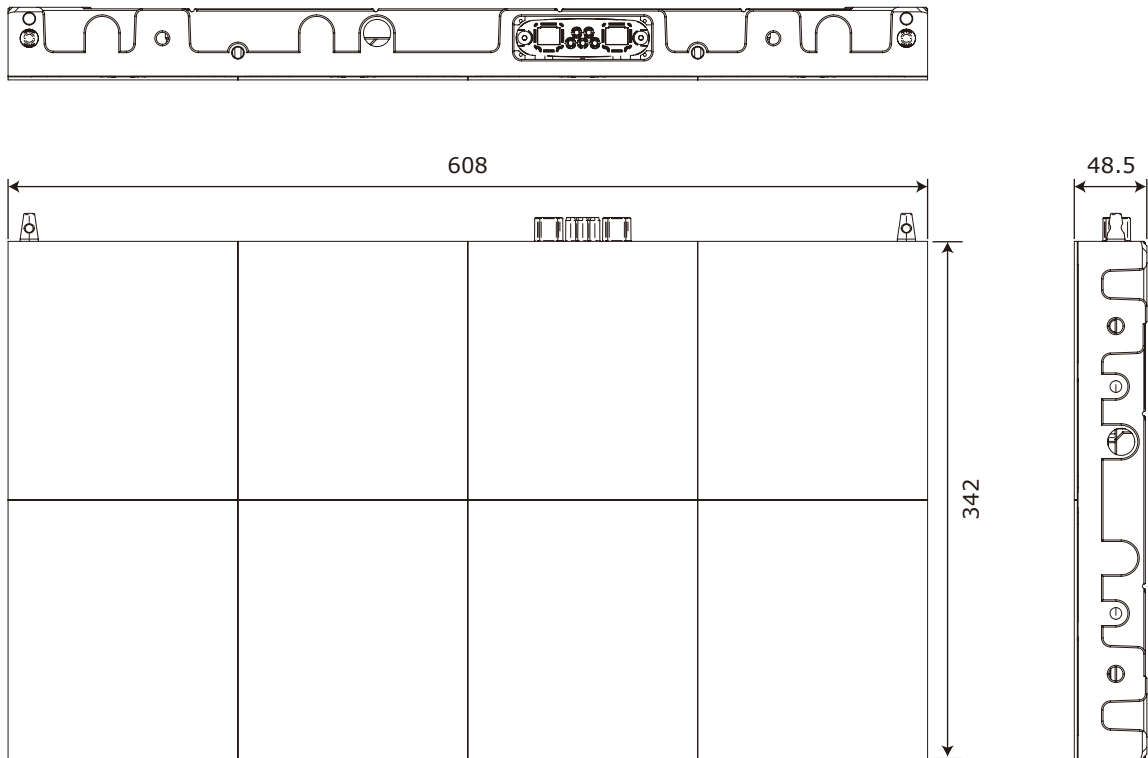

Rear

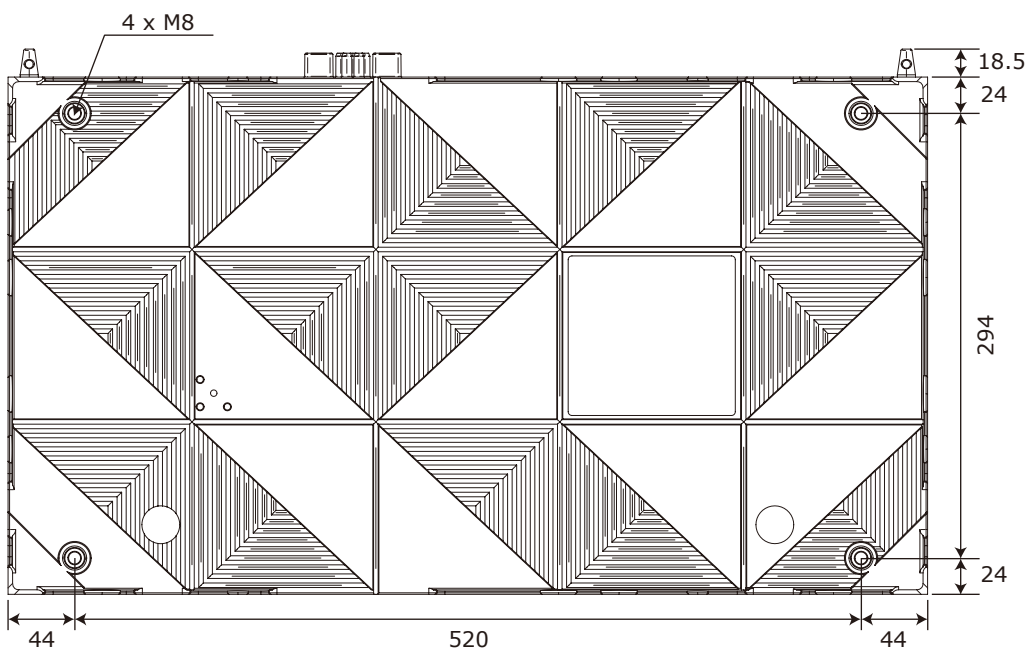

(Unit: mm)

LED-FC009i / LED-FC012i / LED-FC015i Adjustment plate

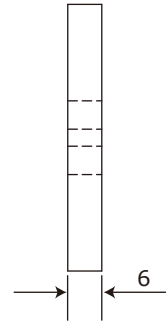
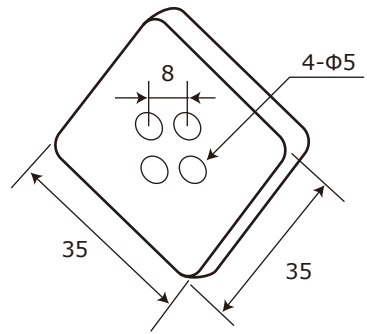

(Unit: mm)