

Installation and Maintenance manual

LED Display Kit

[Models for indoor use]

LED-E012i-108

LED-E012i-217

LED-E015i-135

LED-E018i-162

LED-E025i-217

MODELS: LED-E012i, LED-E015i, LED-E018i, LED-E025i

Table of Contents

Important Information	English-1
About the LED lamps	English-4
Lamp break-in	English-4
Contents	English-5
Parts Name	English-7
Installation Example	English-8
1. Installation location.....	8
2. Installation Setup	10
3. Wiring	22
4. Installing the pixel card	27
Screen Configuration	English-29
Image Setting	English-38
Maintenance	English-40
Troubleshooting	English-43
1. Display problems	43
2. State monitoring using the software	44
Specifications	English-49
Diagram	English-50



Important Information

Safety Precautions and Maintenance



FOR OPTIMUM PERFORMANCE, PLEASE NOTE
THE FOLLOWING WHEN SETTING UP AND
USING THE LED DISPLAY SYSTEM:

About the Symbols

To ensure safe and proper use of the product, this manual uses a number of symbols to prevent injury to you and others as well as damage to property. The symbols and their meanings are described below. Be sure to understand them thoroughly before reading this manual.















 WARNING	Failing to heed this symbol and handling the product incorrectly could result in accidents leading to major injury or death.
 CAUTION	Failing to heed this symbol and handling the product incorrectly could result in personal injury or damage to surrounding property.

Examples of symbols











	⚠ Indicates a warning or caution. This symbol indicates you should be careful of electric shocks.
	⊘ Indicates a prohibited action. This symbol indicates something that must be prohibited.
	● Indicates a mandatory action. This symbol indicates that the power cord should be unplugged from the power outlet.

- Be sure to read the following before using the product to use it correctly and safely.

WARNING

-  Do not apply vibrations or shocks to the product.
-  Do not install the product to unstable locations or locations subject to vibrations.
-  Always ask a technician to perform the installation.
-  Do not connect the cables with wet hands. Otherwise, it may cause an injury or an electrical shock.
-  Do not repair or modify the product yourself. Otherwise, it may cause an injury, a fire or an electrical shock.
-  In case of thunder, do not touch the power cord. Otherwise, it may cause an electrical shock.
-  Connect the product to the correct voltage. If the product is connected to a voltage other than the specified voltage, it may lead to a fire or an electrical shock.
-  In case of a malfunction (nothing is displayed on the screen, etc.) or if smoke, abnormal heat, or a strange sound or odor is generated, turn the power off and immediately ask a technician or your retailer for repair.
-  Install the product so that the vents are not obstructed.
-  Make sure there are enough people available to ensure safety (at least two people) when installing or moving the product. Otherwise, it may lead to an injury.
-  Be sure to ground the product. If the product is not grounded, there is a risk of electrical shock in case a malfunction occurs.
-  In case foreign matter has entered into the product, immediately disconnect the power supply and stop using the product.
-  After the installation, if a problem such as loose screws occurs, immediately ask a technician or your retailer for repair.
-  Do not put objects into the product. Otherwise, it may cause a fire or an electrical shock.
-  In case the product is in contact with water or another liquid, immediately disconnect the power supply and stop using the product. If you continue using the product in that state, it may lead to a malfunction, a fire, or an electrical shock.

CAUTION

-  Do not damage the power cord. Do not put heavy objects on it, place it near heaters, pull it with excessive strength, or apply a strong force on it while it is bent. A damaged power cord may cause a fire or an electrical shock.
-  Do not install the product in narrow places where heat tends to build up.
-  Do not use the product in an environment with low heat dissipation. Otherwise, it may cause a malfunction.
-  The RJ-45 port of the product is for use with the product only. Do not connect it to a network. Connecting this port to a network that may receive over-voltage current may cause damage to the product or an electrical shock.
-  Do not use the product in a vehicle or another means of transportation.
-  Do not use or store the product in the following places.
 - Near heaters
 - Places with lots of humidity or dust, or places subject to oily smoke
 - Places where water or oil may splash
 - Places with lots of corrosive gases, such as near hot springs
 - Places where the product may freeze
 - Do not place the product on its side, face down, or upside down.
 - Places with lots of vibrations
-  If you will not be using the product for a long time, disconnect it from the power distributor for safety purposes.
-  Disconnect the power supply when performing the maintenance.
-  Install the product in accordance with the local laws and regulations.
-  Do not place the product under direct sunlight or near heaters.
-  This product is designed to be used indoors. Do not use it outdoors. Otherwise, it may cause a malfunction.

This product can only be serviced in the country where it was purchased.

About the LED lamps



LED lamps are sensitive to static electricity and surge voltage, which may damage their components and decrease their reliability.

Take measures against static electricity during the installation. Do not touch the LED display areas.

The LED lamps may absorb and hold moisture during the LED module installation or if not used for a long time. Therefore, in such cases, the brightness must be increased gradually during a break-in period before setting the normal brightness.



If the LED lamps are lit with 100% brightness while moisture is retained, the temperature will rise very quickly and the water inside the lamps will evaporate and expand. This will cause the encapsulating resin to expand, which may lead to separation of the boundary surface inside the LED lamps. This separation can cause the LED lamps not to light up properly.

Lamp break-in



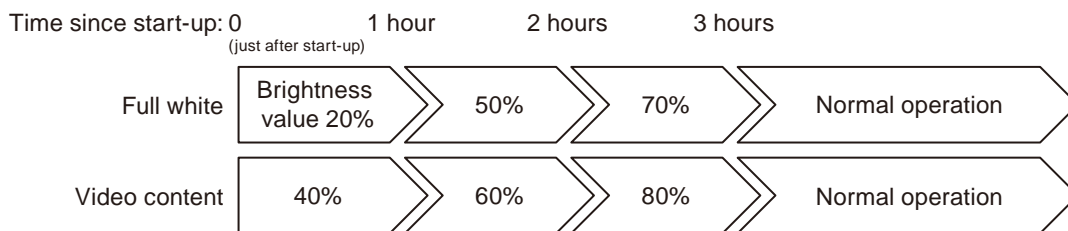





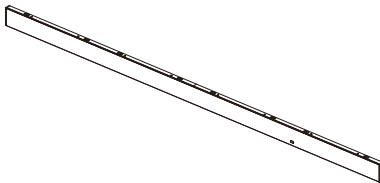
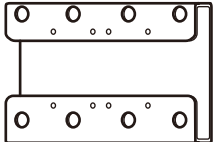

Configure the brightness settings as shown below with a video displayed on the LED module. After a break-in period of approximately 3 hours, the LED module can be used under normal conditions.

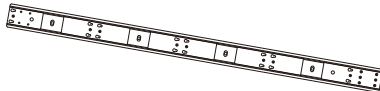

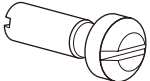
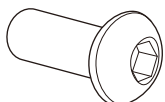
Contents

The supplied parts are as follows.

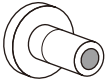
In case one of these parts is missing or damaged, contact the retailer.

Parts	Specifications	Quantity					
		LED-E012i-108	LED-E015i-135	LED-E018i-162	LED-E012i-217	LED-E025i-217	
Bottom frame		1	1	1	2		
Bottom frame connecting part		-	-	-	1		
Bottom frame connecting screw	PM3	-	-	-	8		
	KM3	-	-	-	8		
Mounting bar		2	2	3	4		
Alignment bar		2	2	2	2		
Cabinet hanger pin	Head diameter 10 mm x 25 mm	16	20	36	64		
Bottom frame screw	M6 x 16	6	6	9	12		
Over frame (top)		1	1	1	1		
Over frame (left, right)		2	2	2	2		
Corner frame		2	2	2	2		
Slot nut	M3 x 13 mm	12	15	18	24		
Screw for the slot nut	M3 x 10 mm	12	15	18	24		

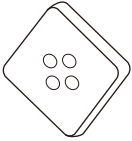
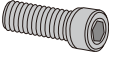
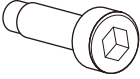
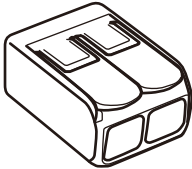
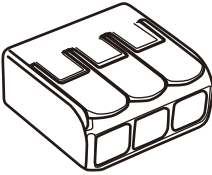
Parts	Specifications	Quantity					
		LED-E012i-108	LED-E015i-135	LED-E018i-162	LED-E012i-217	LED-E025i-217	
Cabinet alignment bracket	35 x 35 x 6 mm	10	12	14	18		
Fixing screw for the cabinet alignment bracket	Hexagonal socket head screw (M4 x 12)	40	48	56	72		
Pixel card		64	100	144	256		
Cabinet	600 mm x 337.5 mm	16	25	36	64		
Connection screw for LED modules	M6 x 26 mm	56	90	132	240		
LED controller	Novastar MCTRL 660Pro	1	1	1	-	1	
	Novastar MCTRL 4K	-	-	-	1	-	
LAN cable for the LED modules	750 mm	-	-	-	-	4	
	200 mm	12	20	30	48	56	
LAN cable for the LED controller	20000 mm	4	5	6	8	8	
	24000 mm	-	-	-	8	-	
Power cord for the LED modules	950 mm	2	2	-	-		
	300 mm	-	1	6	8		
Power cord for the LED controller		1	1	1	1		
Power cord connector	WAGO (2pcs)	4	6	12	16		
	WAGO (3pcs)	2	3	6	8		
USB flash memory		1	1	1	1		
Safety Manual		1	1	1	1		
Packing list		1	1	1	1		

Parts Name

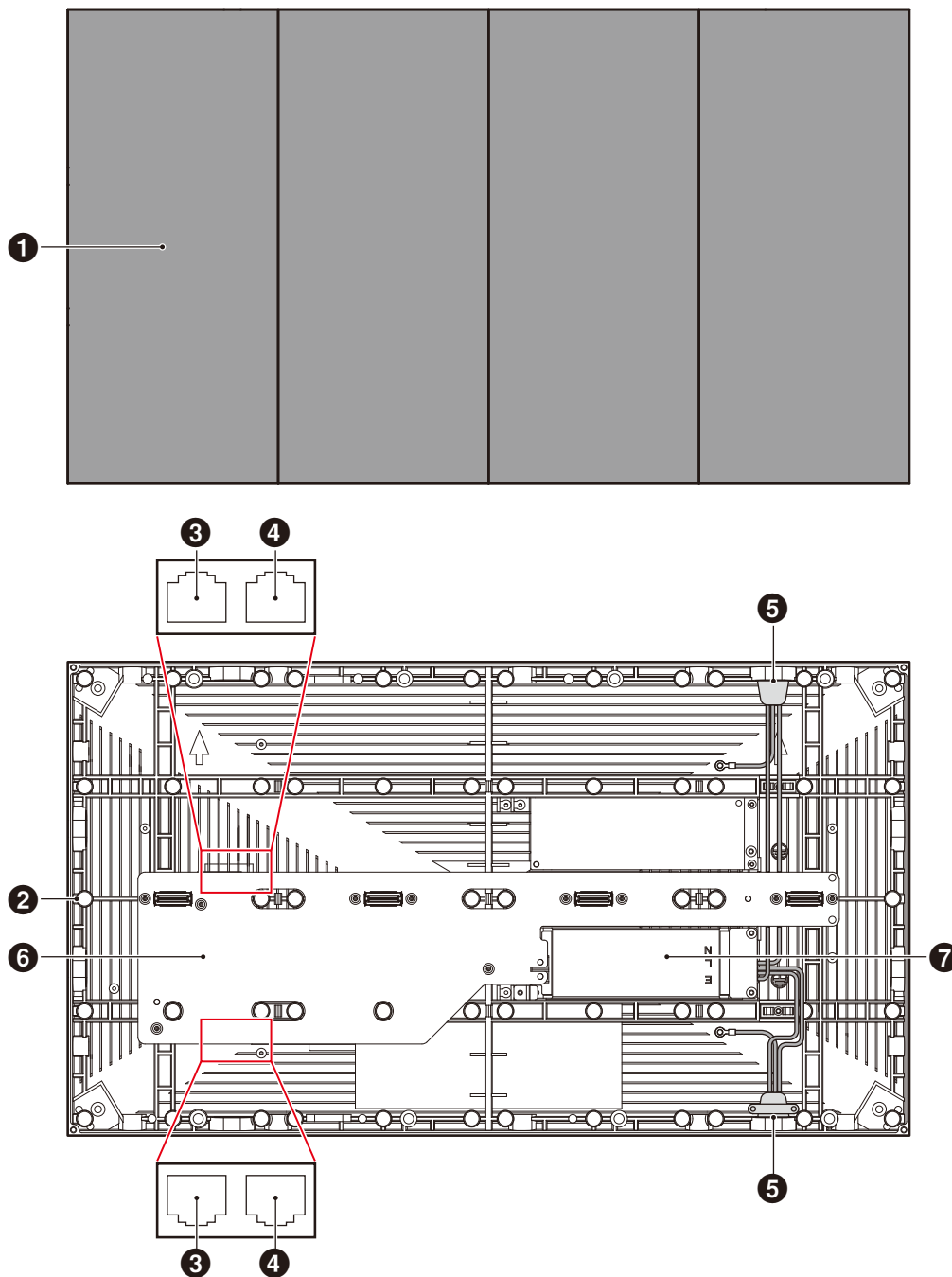

- ❶ Pixel card
- ❷ Cabinet
- ❸ LAN cable input/output
- ❹ LAN cable input (not used with this product)
- ❺ Power cord input/output
- ❻ Hub board
- ❼ Power unit

Installation Example

1. Installation location

Before the installation, be sure to review the following safety precautions to ensure proper and safe installation.

⚠ CAUTION

- Ask a technician to perform the installation.
- Make sure the product is moved and installed by enough people to ensure safety.
- Make sure that the beams or the other structures to which the product is installed have enough strength to support the weight of the product, and make sure that the product is securely fixed.
- Do not install directly the product to a surface that has not enough strength.
- When installing the product in a narrow place (in a wall, etc.), leave gaps around the LED screens as shown in the figure below to prevent an increase in the temperature. The figure below is only an example. Pay particular attention to the installation environment (heat from the external environment, direct sunlight, heat generated by the number of displays) in order to facilitate cooling of the LED modules. If cooling is not sufficient, take measures, such as increasing the distance from the walls or installing a forced-air cooling system. Ask a technician or your retailer for more details.

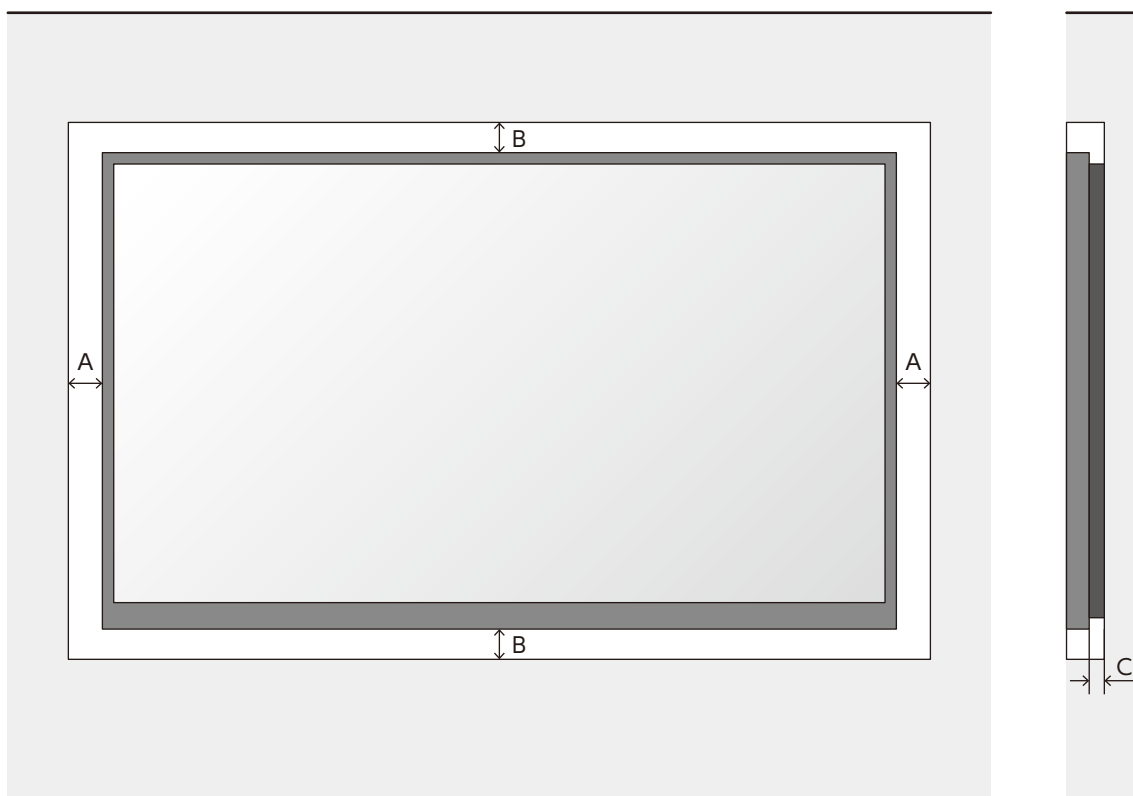

A	B	C
min distance to sides	min. distance to top and bottom	Distance between wall and system
60 mm	60 mm	20 mm

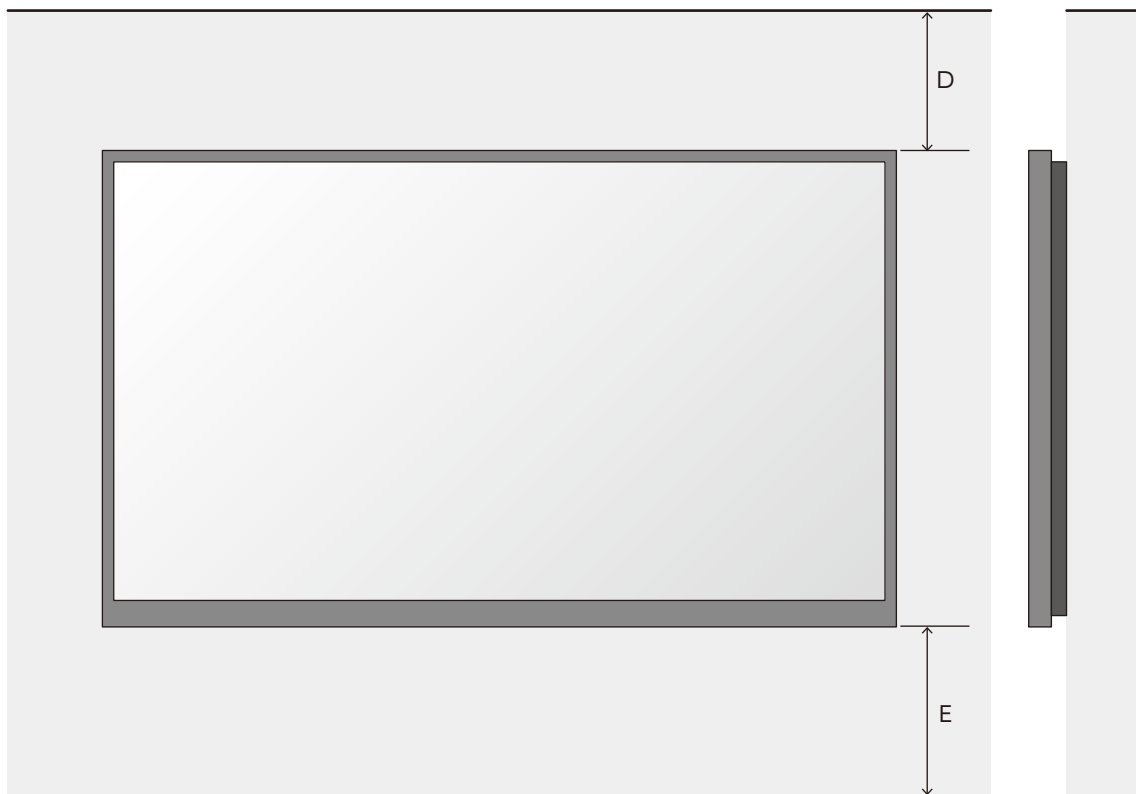

D	E
min. distance to ceiling	min. distance to floor
500 mm	700 mm

2. Installation Setup

2.1 Mark the positions of the anchor points on the wall

- Mark the positions of the holes you will make for the anchor points (refer to the figures below and the "Anchor points number and positions" table on the next page).
- Before making the holes, check the verticality of the marks using a spirit level.

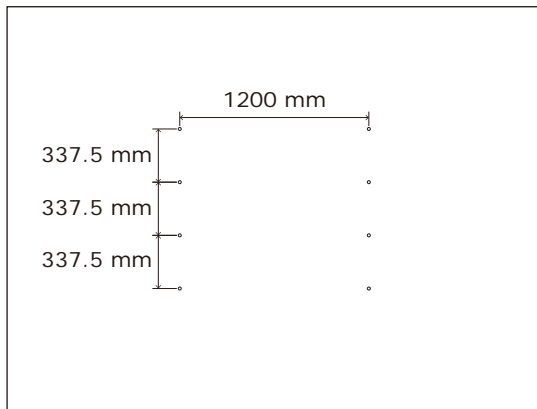

Anchor points positions: LED-E012i-108

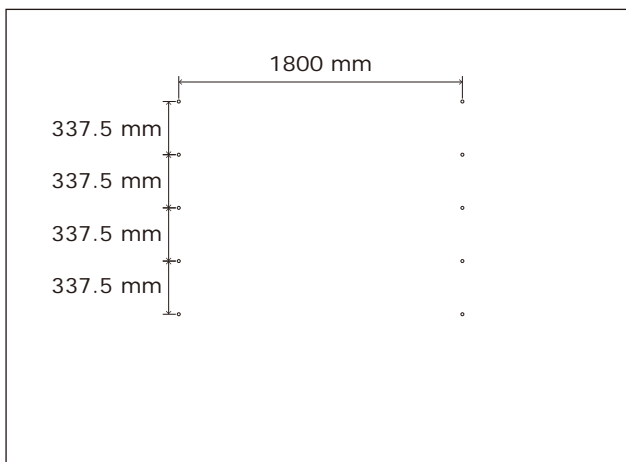

Anchor points positions: LED-E015i-135

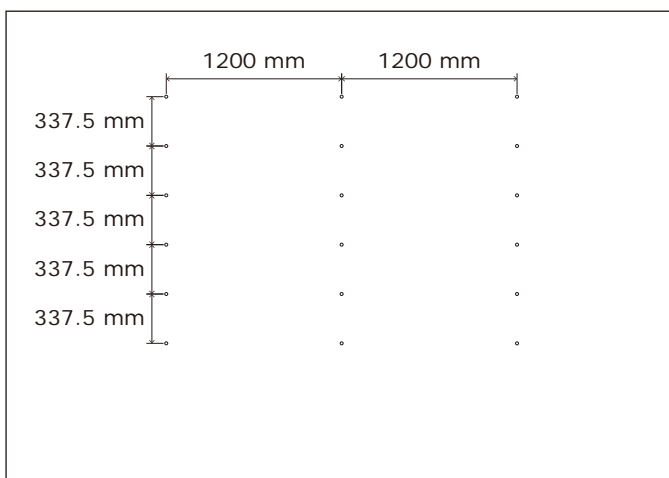

Anchor points positions: LED-E018i-162

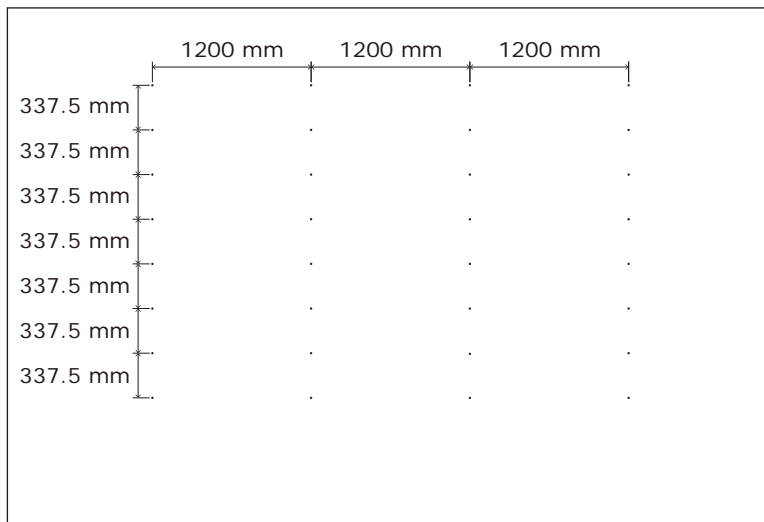

Anchor points positions: LED-E012i-217, LED-E025i-217

Anchor points number and positions

Frame set	LED-E012i-108	LED-E015i-135	LED-E018i-162	LED-E012i-217, LED-E025i-217
Anchor points (horizontal x vertical)	2×4	2×5	3×5	4×8
Horizontal distance	1200 mm	1800 mm	1200 mm	1200 mm
Vertical distance	337.5 mm	337.5 mm	337.5 mm	337.5 mm
Anchor size	Ø10 mm	Ø10 mm	Ø10 mm	Ø10 mm

2.2 Make the holes at the anchor positions

- Make holes at the anchor positions using a suitable tool.
- Use screw anchors/anchor plugs as required.
- Remove the dust or dirt, and wipe off any drilling chips and dust.

2.3 Install the mounting bars

- (1) Install the mounting bars on the anchor points on the wall.
- (2) Check the distance between the mounting bars using the alignment bars.

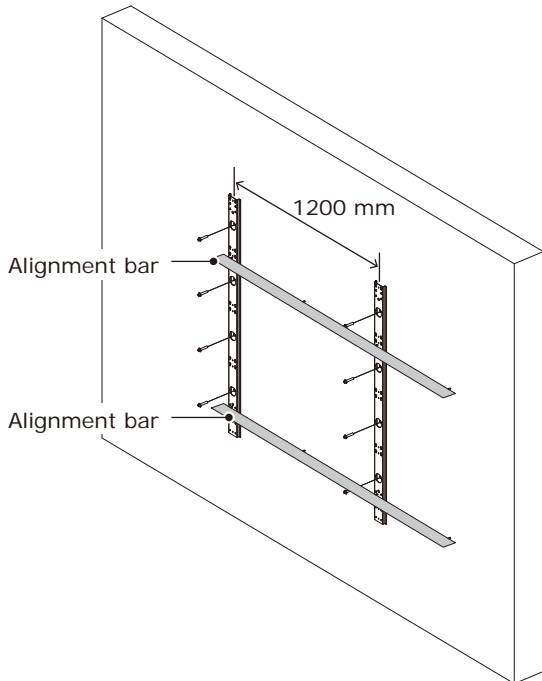

LED-E012i-108

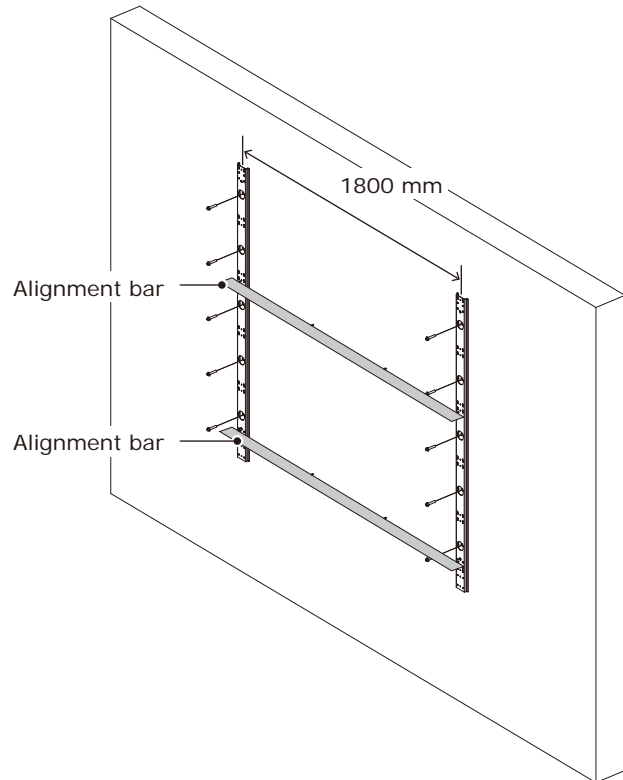

LED-E015i-135

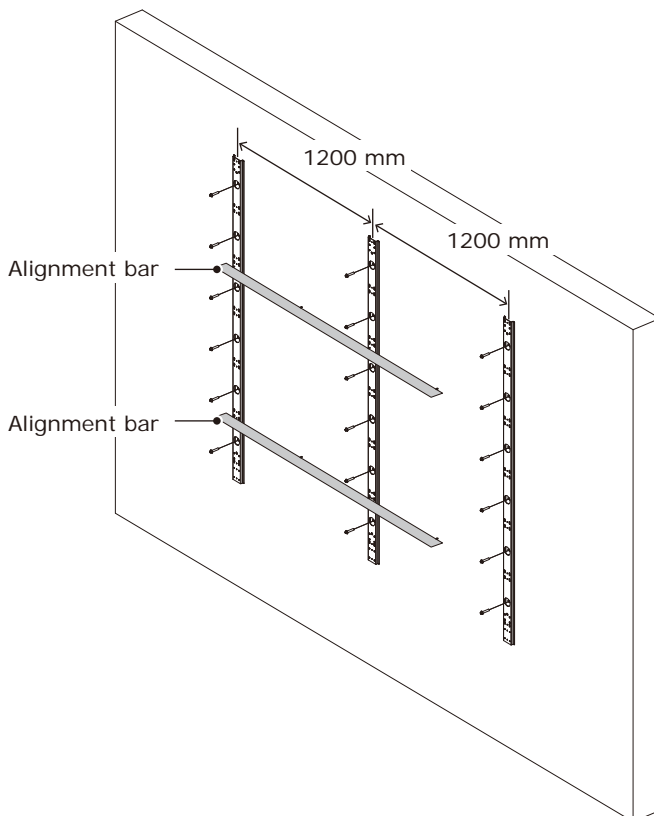

LED-E018i-162

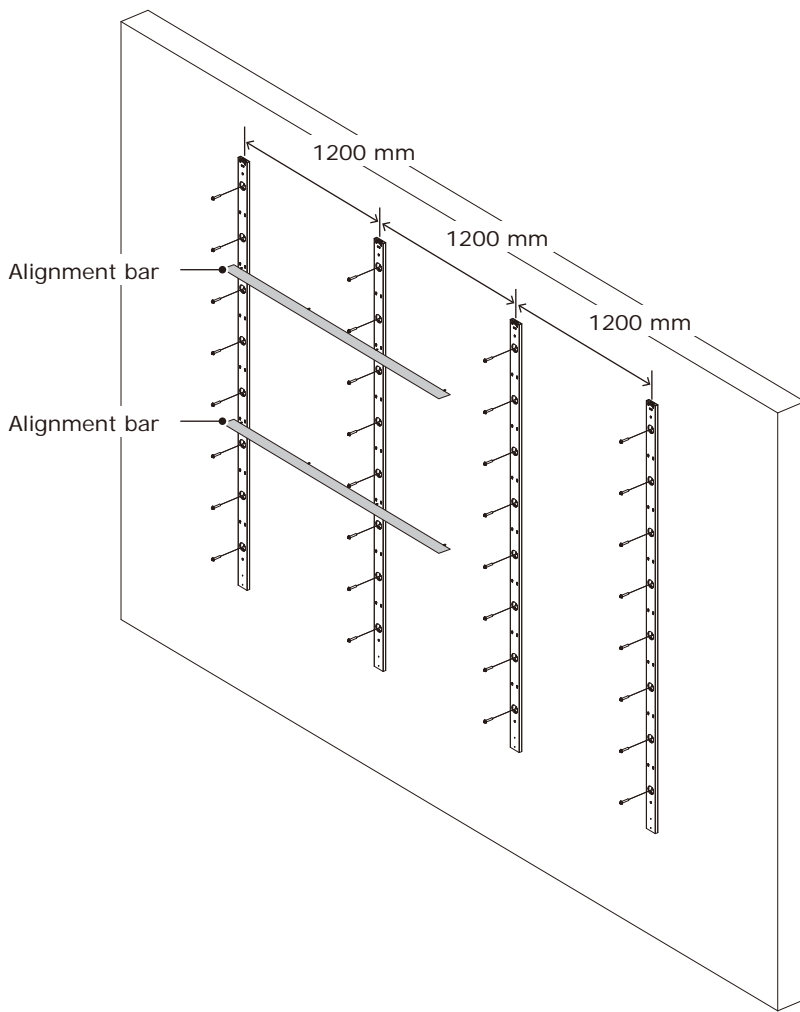

LED-E012i-217, LED-E025i-217

(3) Check the evenness using a spirit level and the alignment bars together. Adjust the positions if required.

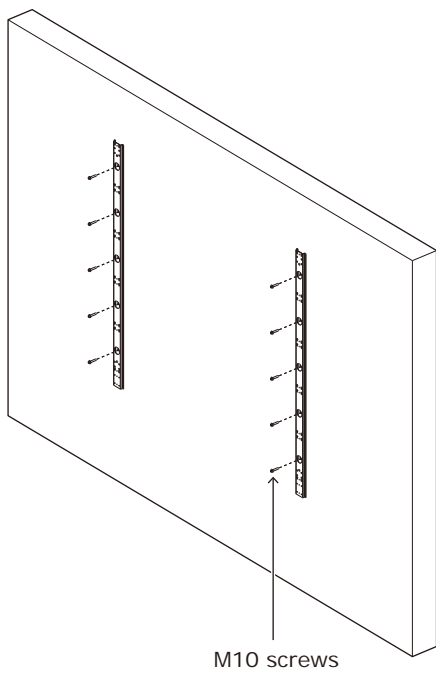

Wall mounted: Mounting bar installation (LED-E015i-135)

2.4 Install the bottom frame

Remove the bottom frame cover and install the bottom frame using M6 screws.

How to remove the bottom cover

(1) Remove the screws securing the bottom frame cover.

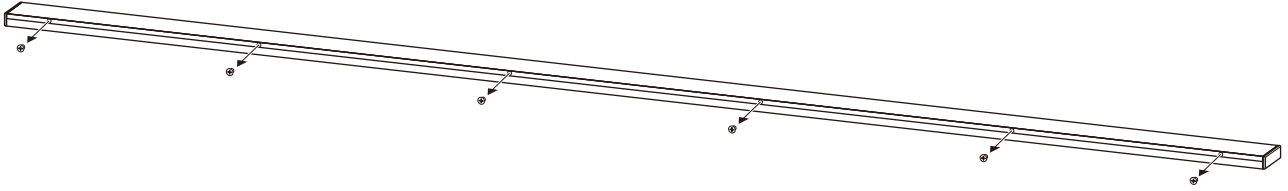

(2) Raise the front of the bottom frame cover.

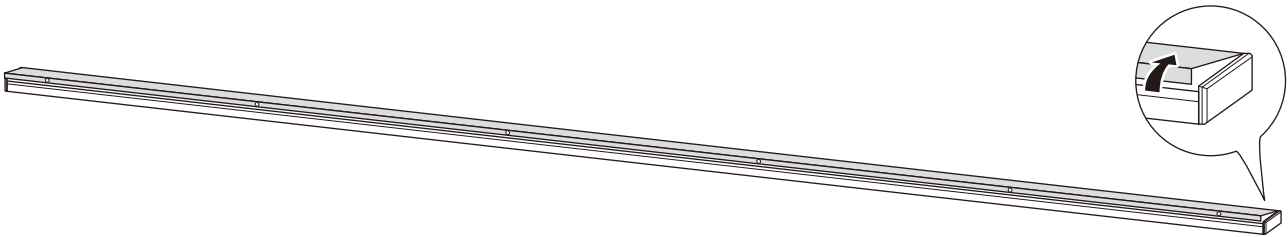

(3) Pull the bottom frame cover toward you to remove it.

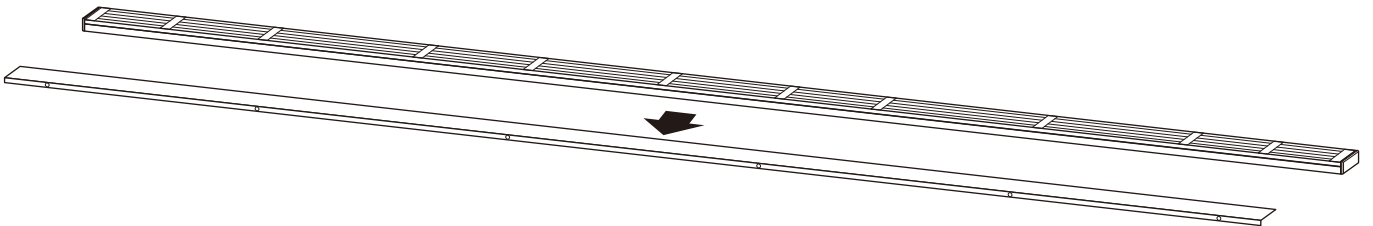

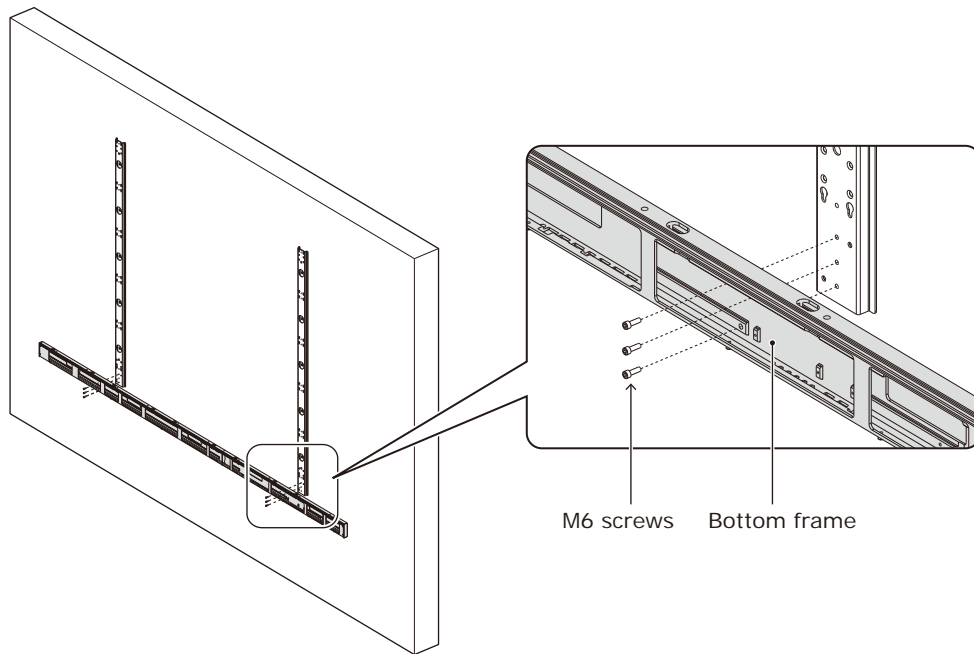

When using the 8 x 8 frame set, use the bottom frame connecting part to install the bottom frame.

Bottom frame connecting screw (PM3)
(8 red circles)

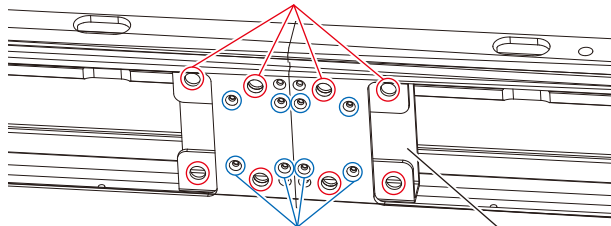

Bottom frame connecting screw (KM3)
(8 blue circles)

Bottom frame connecting part

2.5 Install the cabinet hanger pins to the back of the cabinets

Insert the hanger pins into the four corners of the cabinets up to where there is a difference in their diameter.

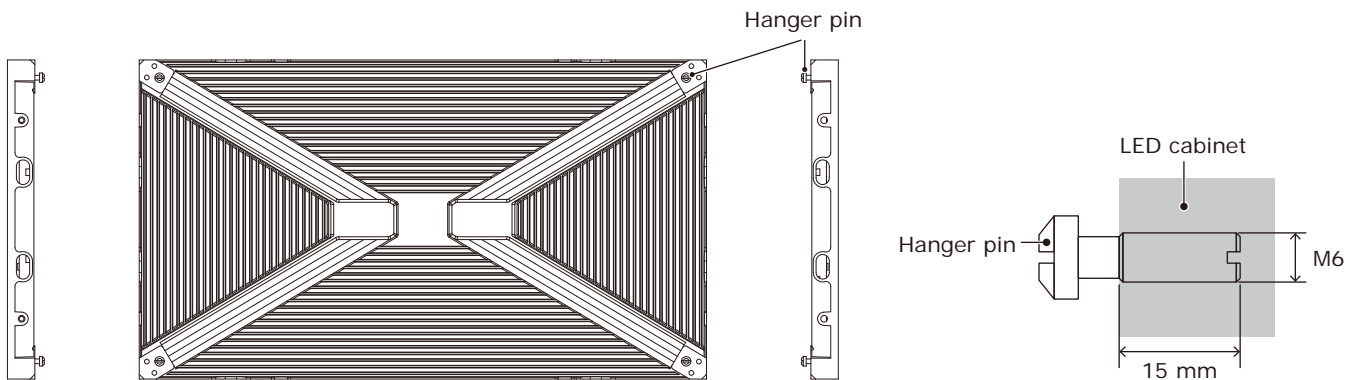

2.6 Install the cabinets

Hook the hanger pins, which have been inserted into the cabinets, into the holes on the mounting bars starting from the lowest row.

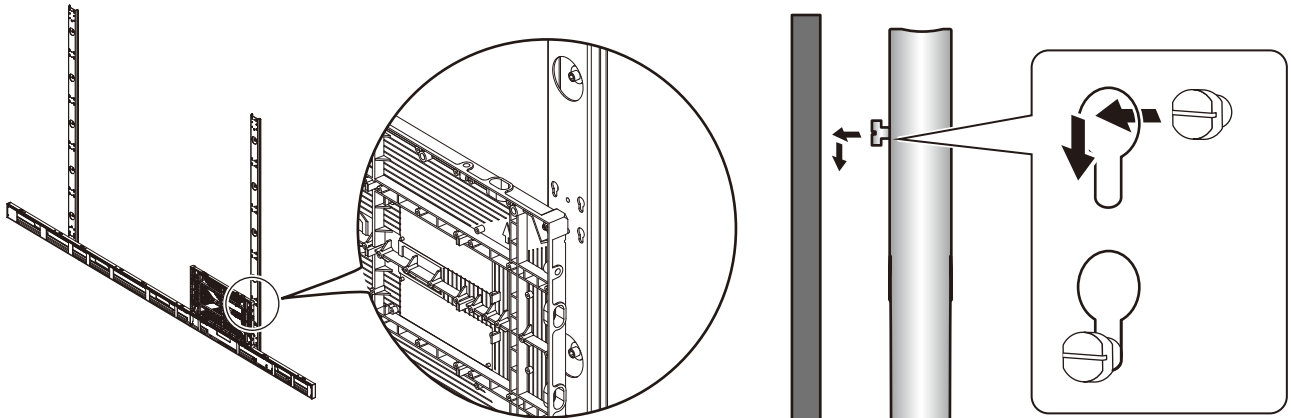

Fix temporarily the cabinets of the first row to the bottom frame.

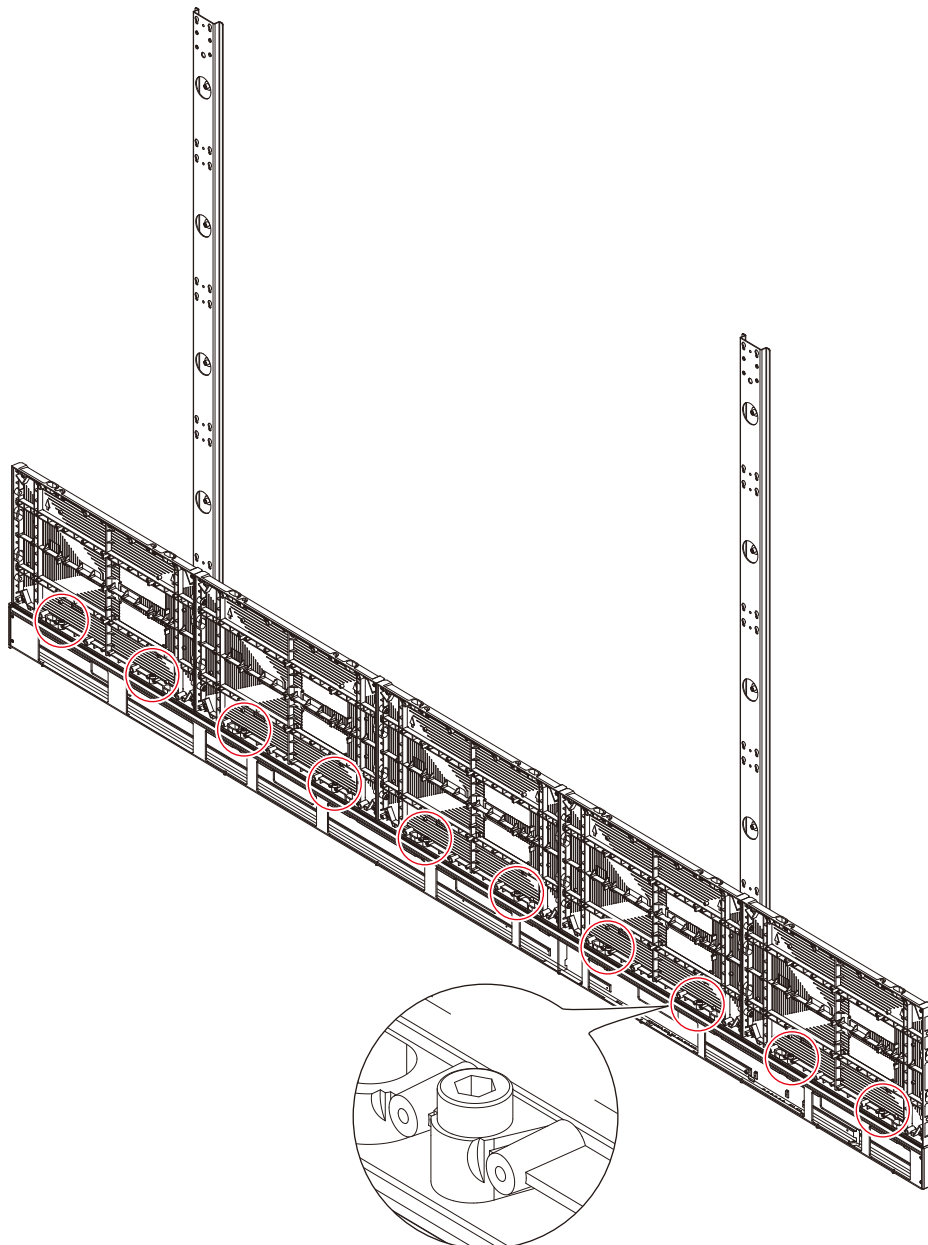

Hook the hanger pins of the cabinets of the second row to the mounting bars.

Secure the LED cabinets together using connection screws for LED modules. Do not tighten the screws completely.

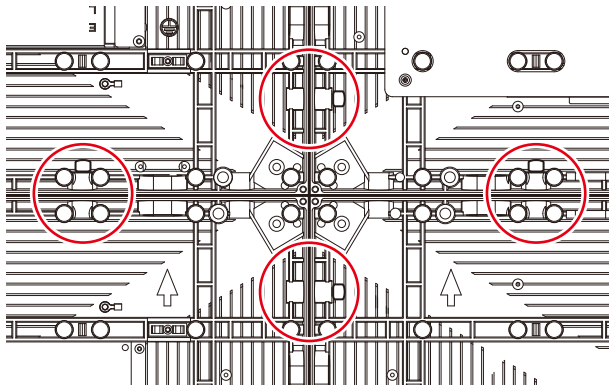

After you have installed two rows of cabinets, align the surfaces of the cabinets using the cabinet alignment brackets.

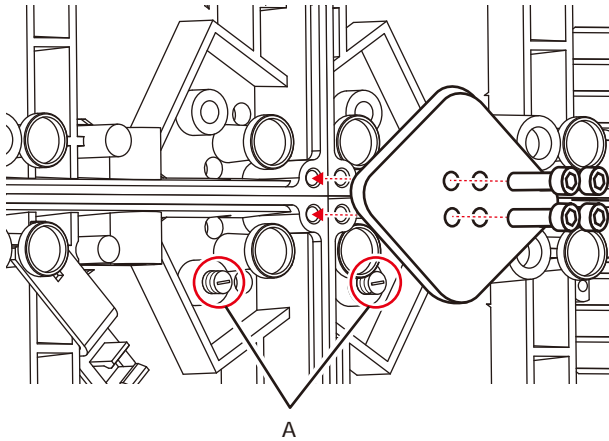

When the cabinets' surfaces are aligned, securely tighten the cabinets of the first row to the bottom frame, the cabinets of the first row together, as well as the cabinets of the first row with the cabinets of the second row. Remove the cabinet alignment brackets after the screws have been tightened.

Adjust the position of the cabinet and the mounting bar by rotating the screws A on the figure with a flat blade screwdriver. Rotate the screws counterclockwise to bring the cabinet closer to the mounting bar.

Follow the same procedure to install the next row of cabinets and align their surfaces.

Connect the power cord and the LAN cable from the opening at the back of the bottom frame.

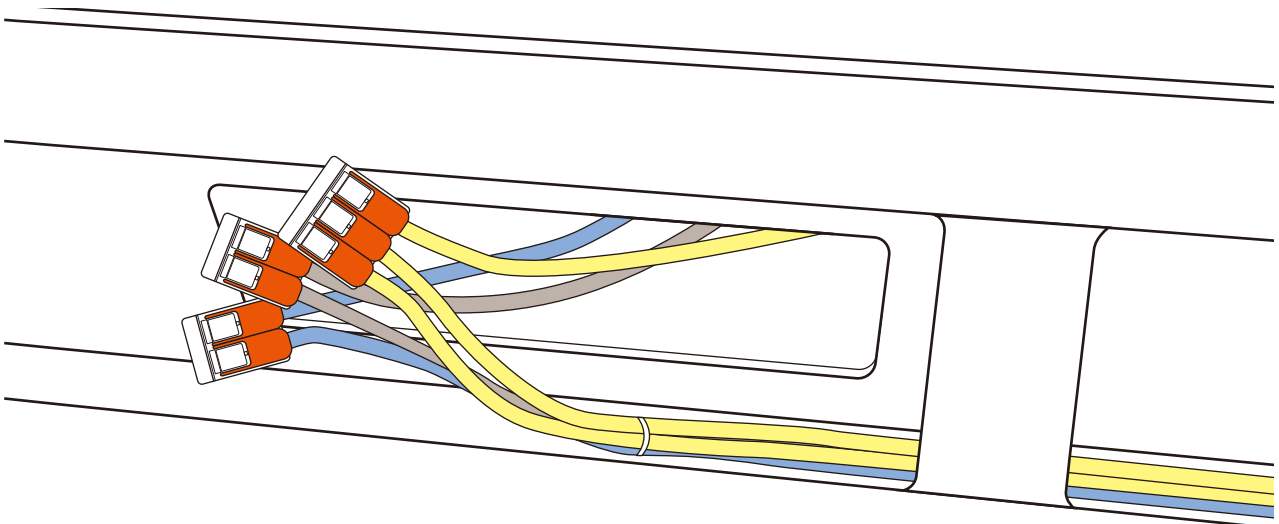

How to connect the power cord

(1) Raise the lever.

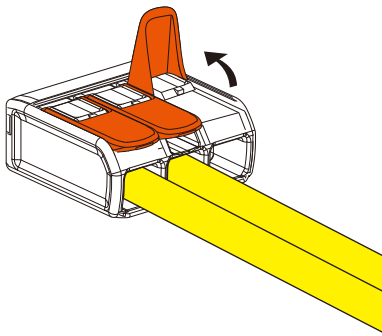

(2) Insert the wire.

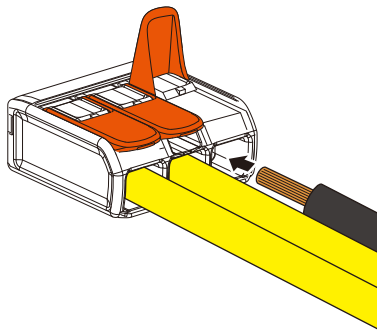

(3) Return the lever to its previous position.

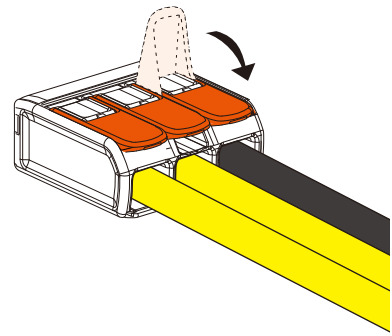

Wire sizes compatible with the power connector (WAGO) are as follows.

Solid core: $\phi 1.6$ to 2.0 mm

IV 7-stranded core: 2.0 to 3.5 mm²

WARNING

Pay attention to the wire colors of the power cord when connecting the cord. If the cables are not connected correctly, it may lead to a fire or an electrical shock.

Blue (N)

Brown (L)

Yellow green (Ground)

Install the bottom frame cover using the screws when it was installed (on the front).

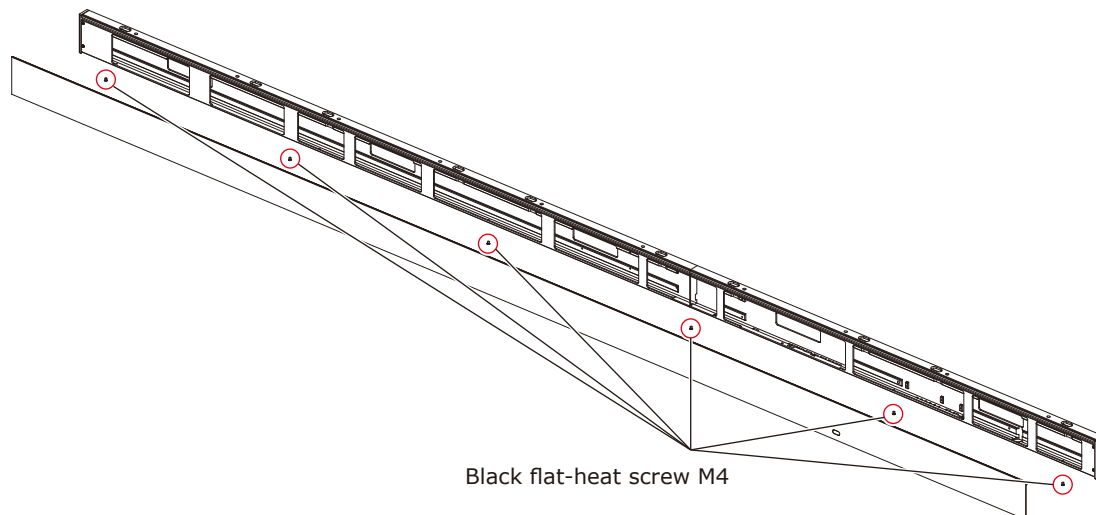

Insert the slot nuts inside the over frame into the holes of the connection screws for the LED modules and fix them with M3 screws.

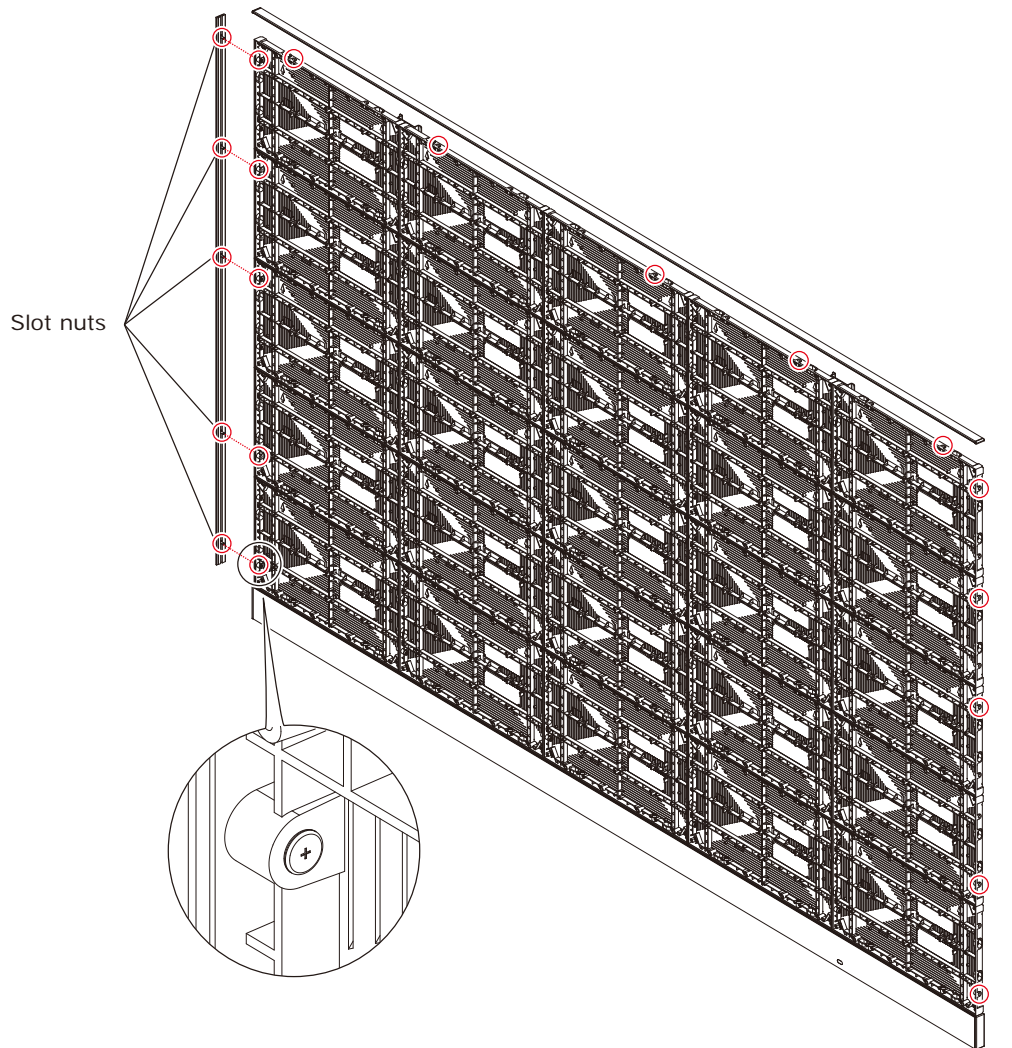

Install the corner parts to the over frame (top) and install it on the top of the cabinets.

Slot nut installation locations

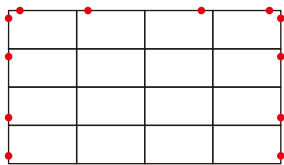

LED-E012i-108

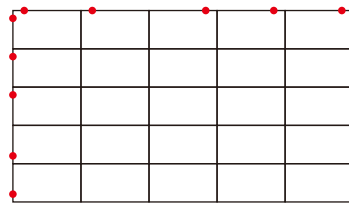

LED-E015i-135

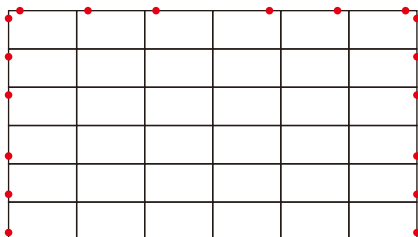

LED-E018i-162

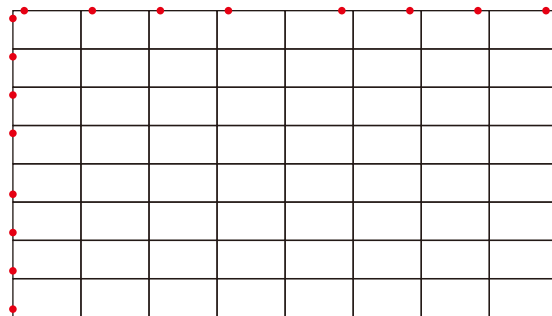

LED-E012i-217, LED-E025i-217

2.7 Assembly diagrams

LED-E012i-108

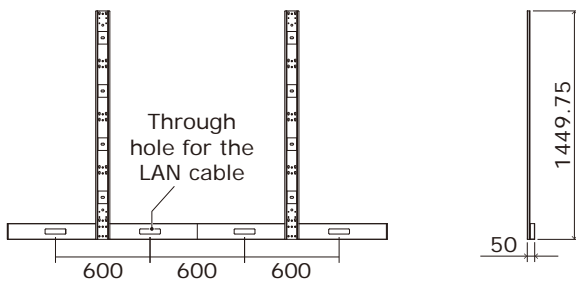
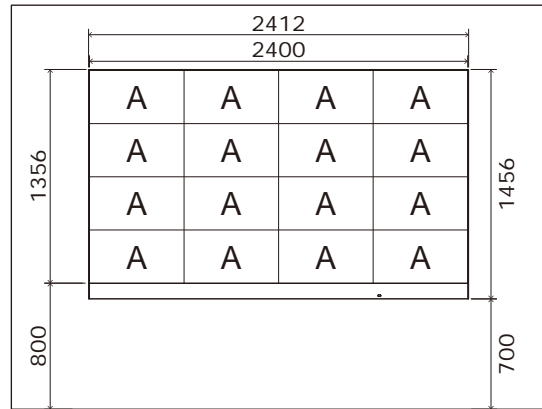
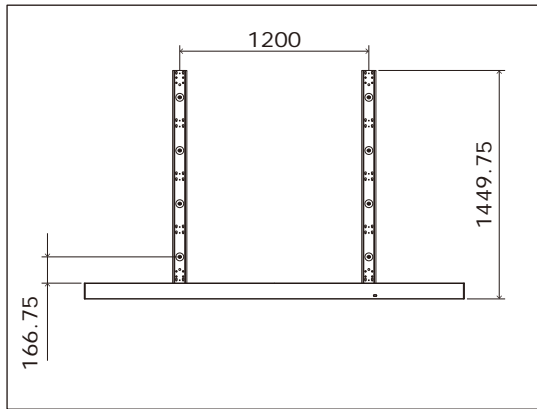

LED-E015i-135

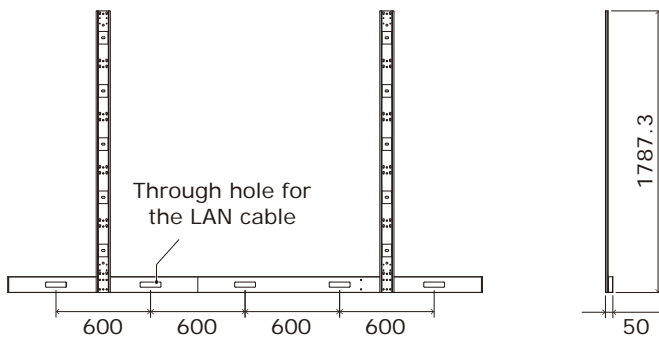
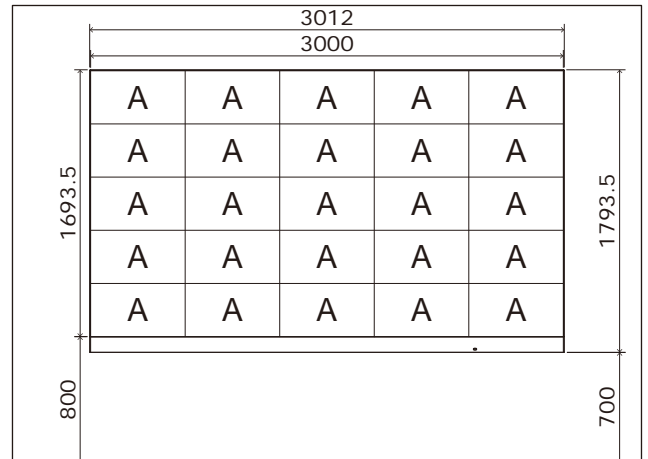
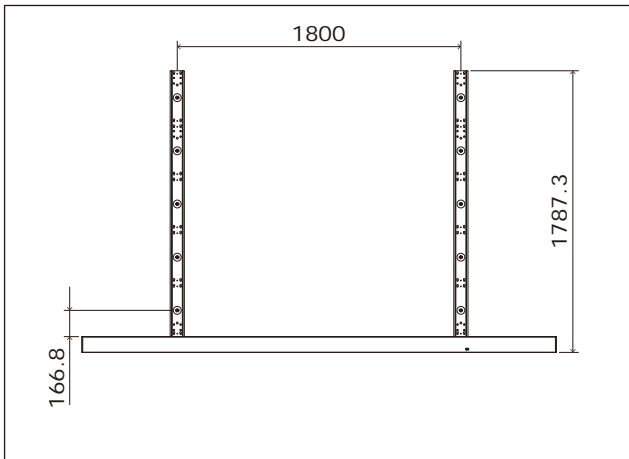

LED-E018i-162

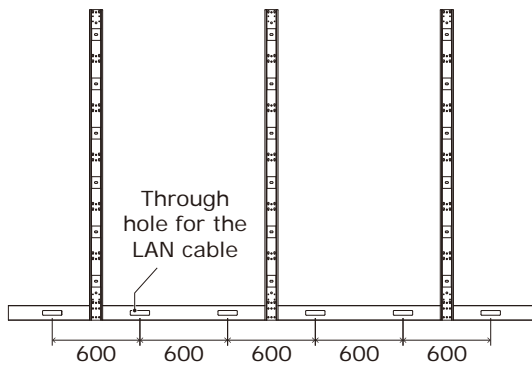
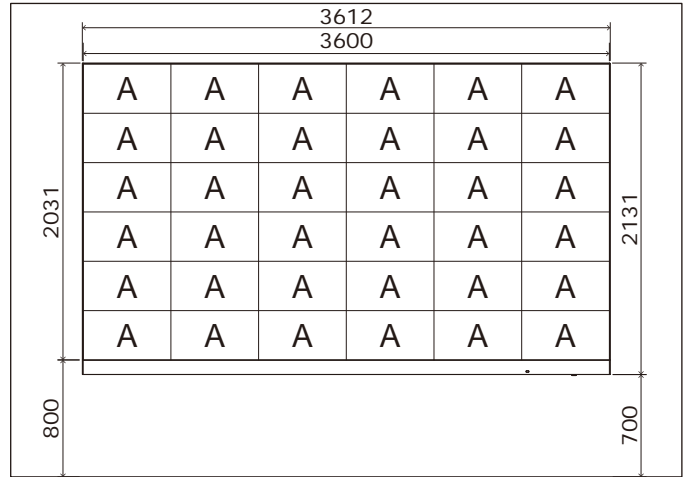
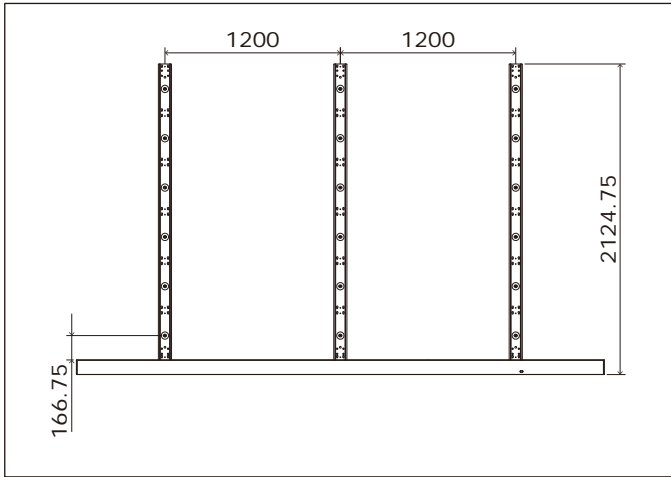

LED-E012i-217, LED-E025i-217

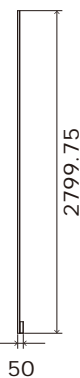
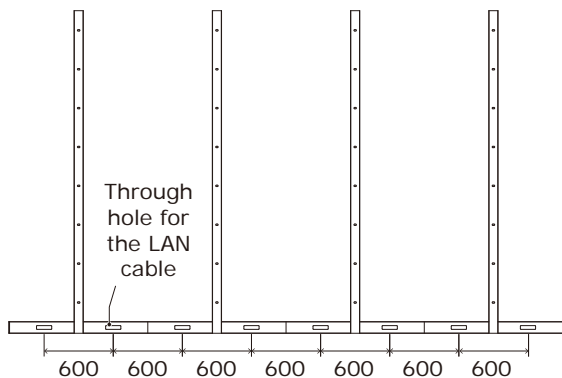
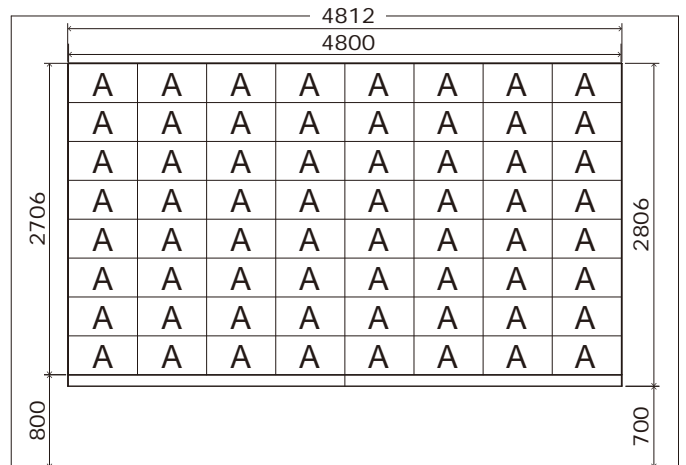
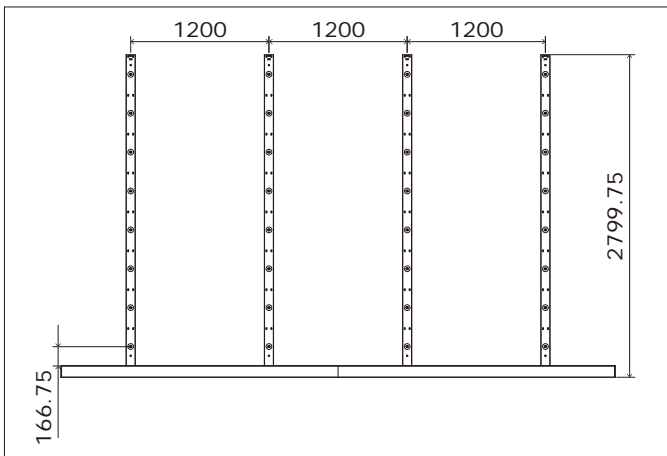

3. Wiring

LED-E012i-108

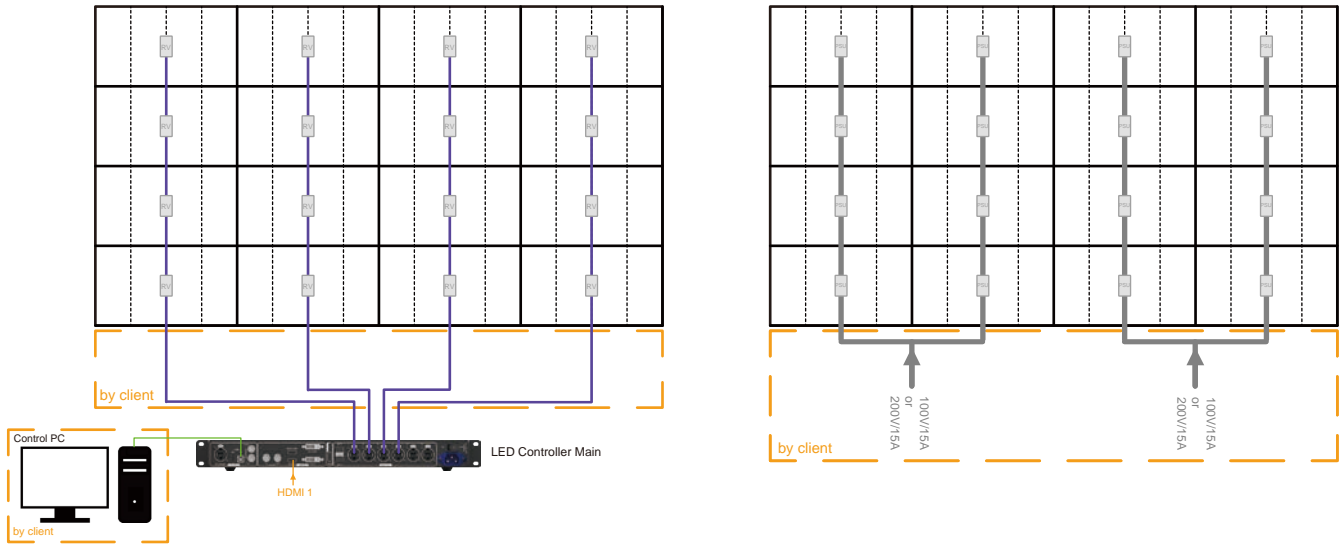

LED-E015i-135

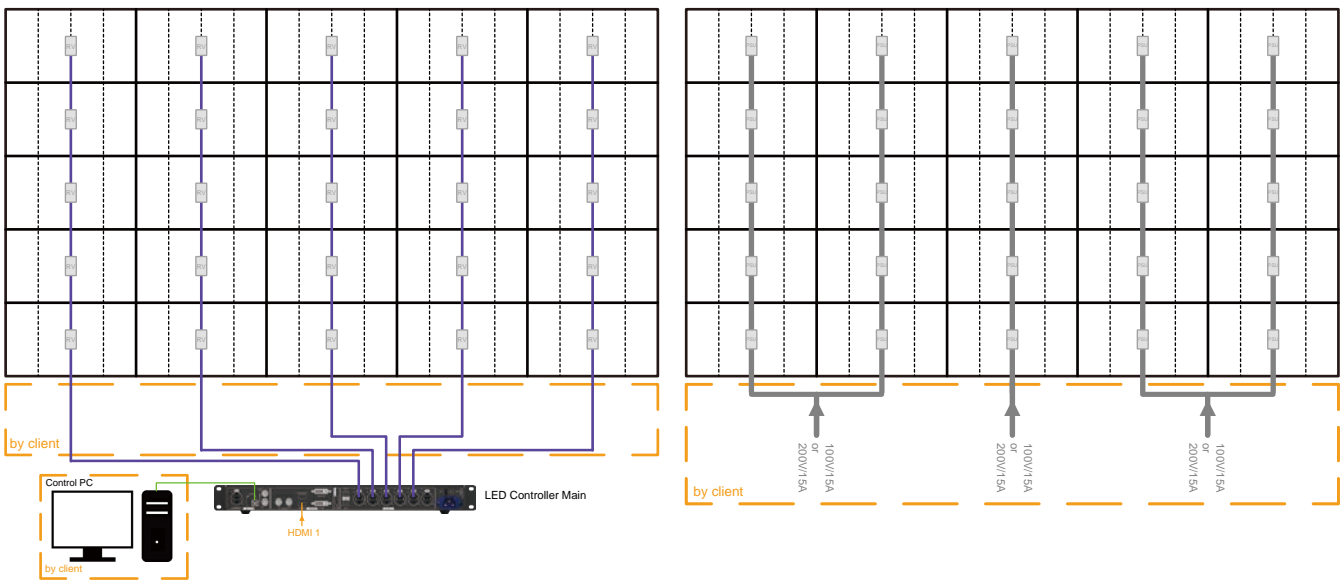

LED-E018i-162

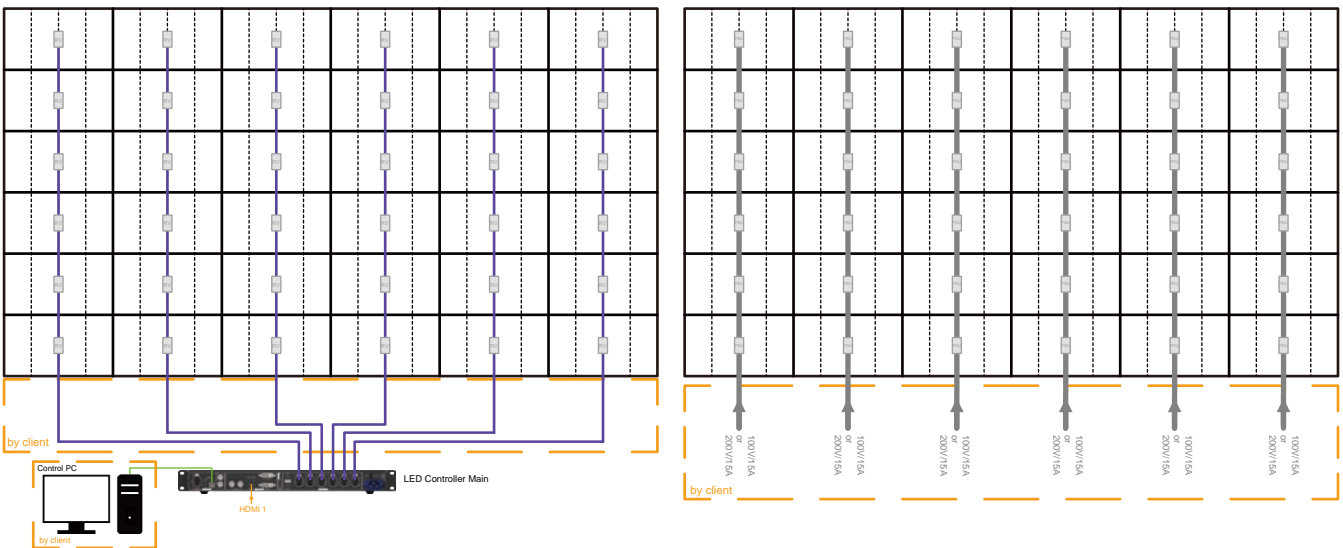

LED-E012i-217

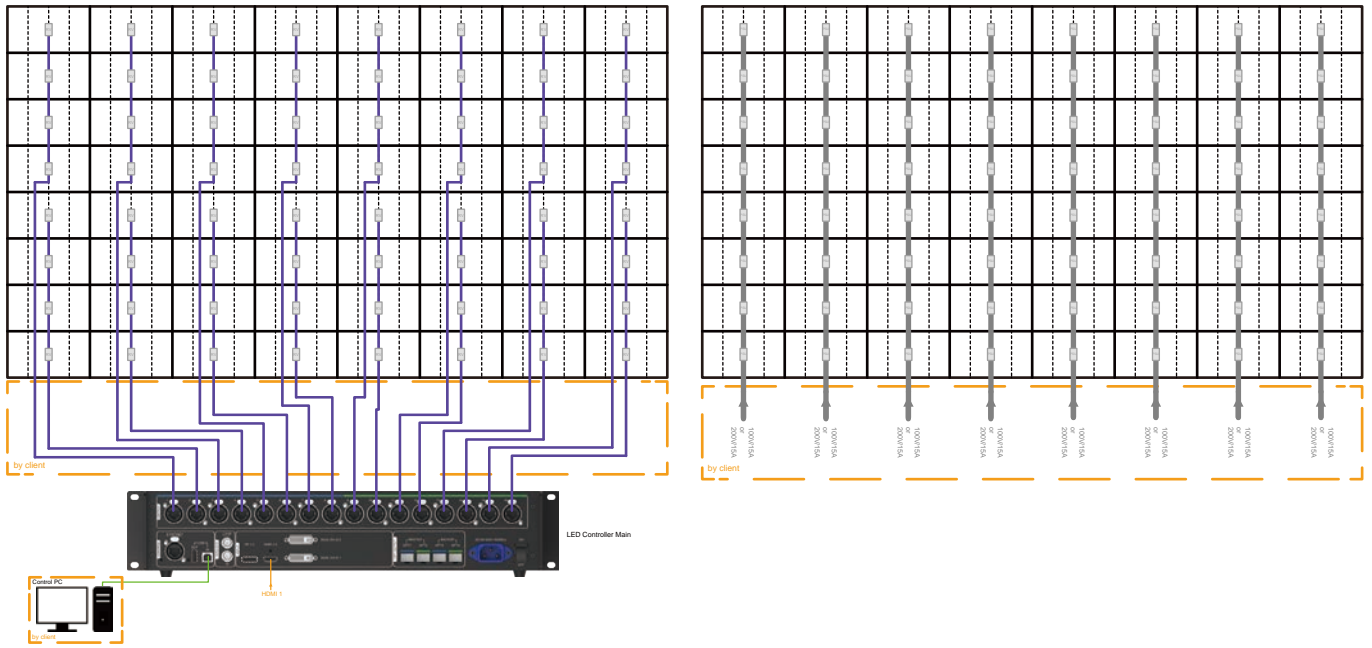

LED-E025i-217

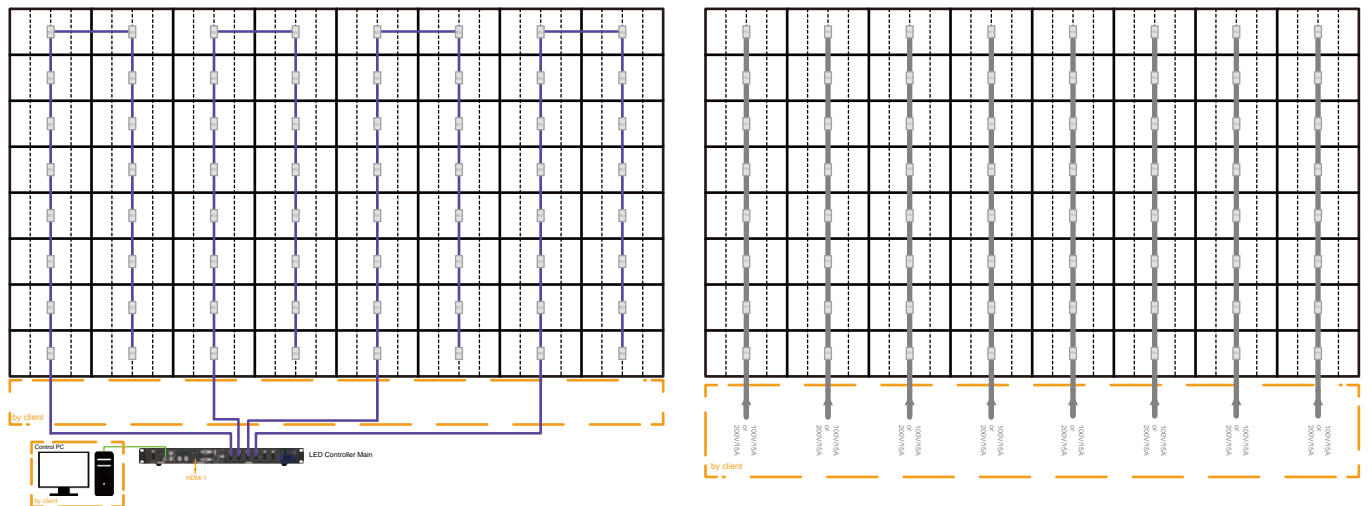

(1) Power cord connection

Connect the power cords to the LED modules on the first row.

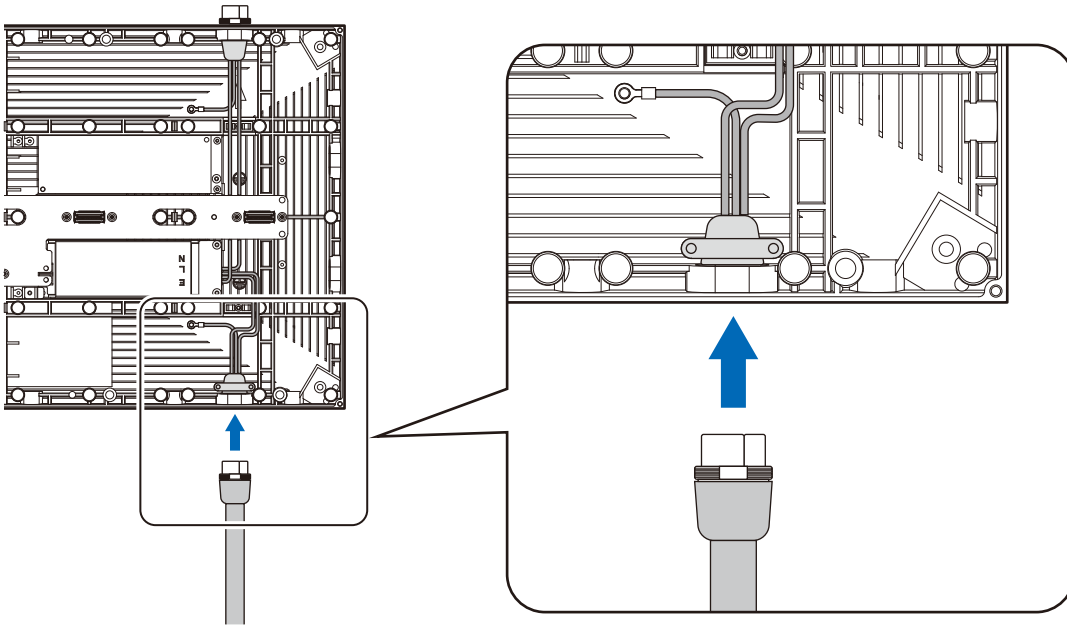

The power cord must be securely plugged.

Connect the power cords between the LED modules.

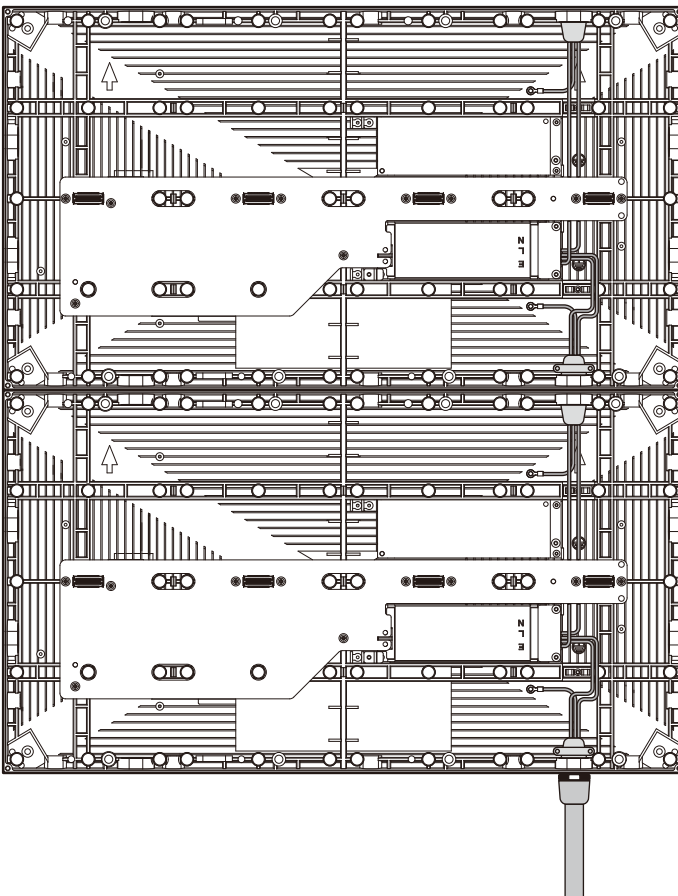

(2) LAN cable connection

Connect the LAN cables for the signal between the LED modules. Use the through holes to pass the cables between the modules.

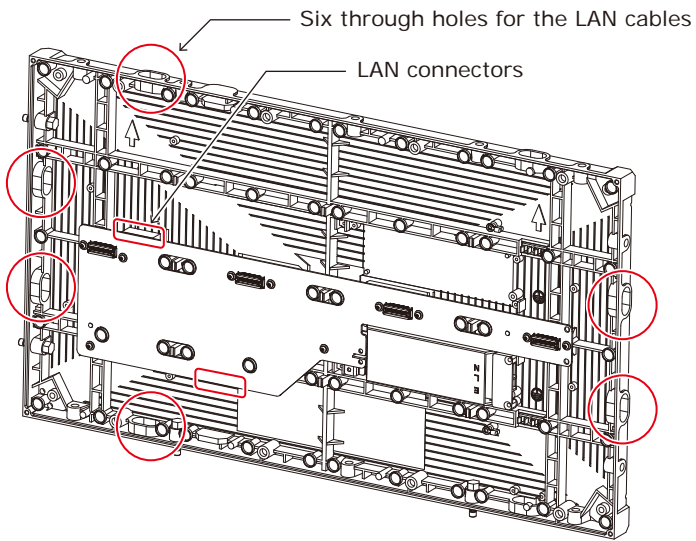

[Connection example 1] Connecting from bottom to top using multiple ports

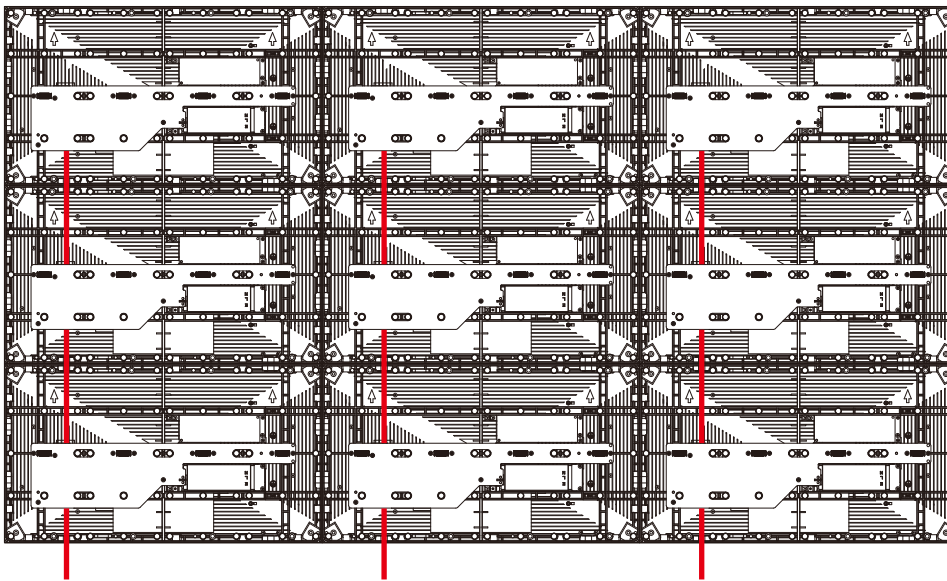

[Connection example 2] Connecting all the LED modules using a single LAN cable

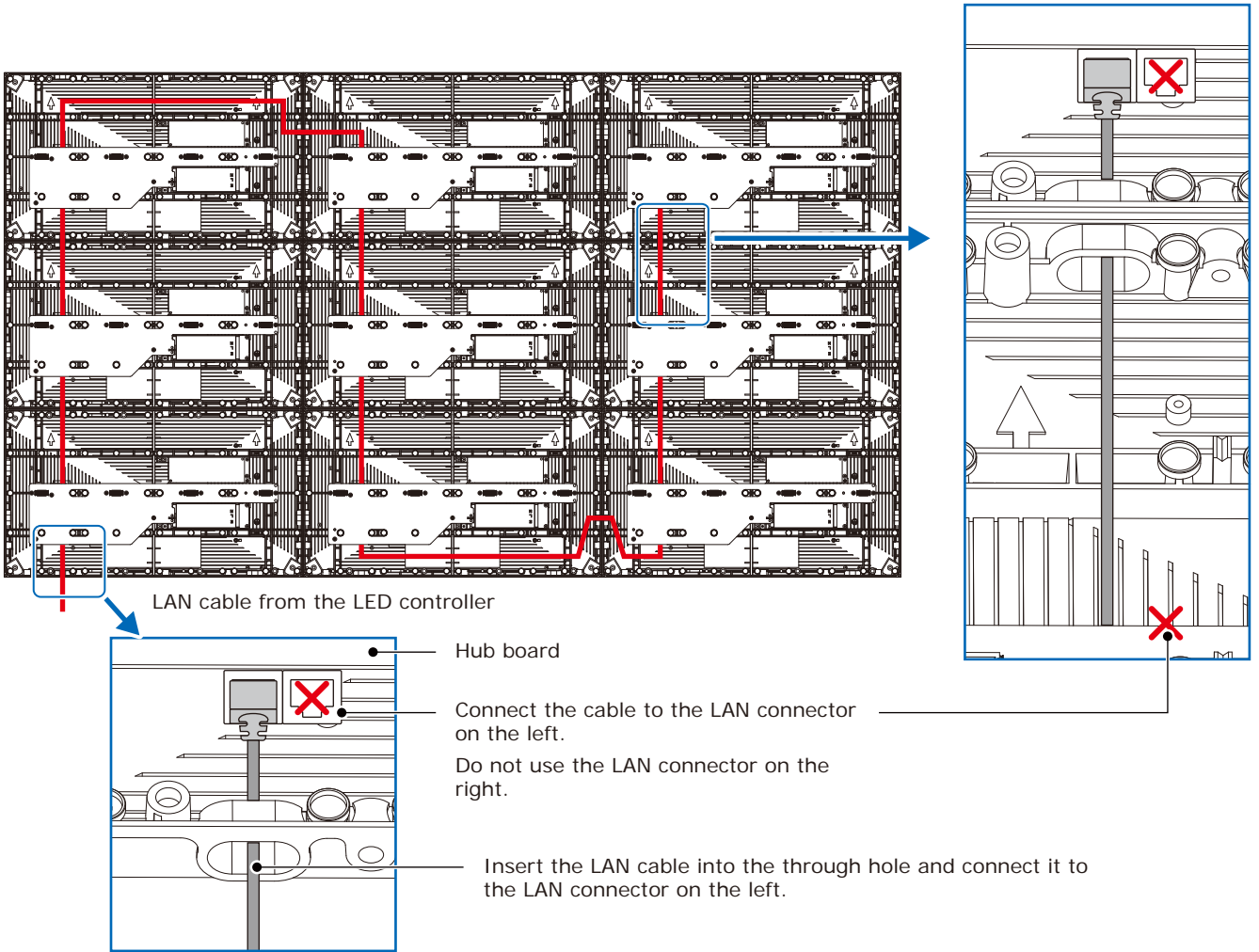

4. Installing the pixel card

CAUTION

- The pixel cards contain powerful magnets. If magnetic cards come close to the pixel cards, the data contained within may be damaged. Therefore, do not carry any magnetic card when installing the pixel cards.
- When installing the pixel cards, pay attention not to damage them against the pixel cards already installed or other objects. Otherwise, the video may not be displayed properly.
- Take measures against static electricity when installing the pixel card. Do not touch the LED display areas and the back of the pixel card.
- Check that the power supply to the LED modules is cut before starting the work.

Install the pixel card using the maintenance tool.

Pull the trigger of the handle to activate the suction function. Release the trigger to stop the suction function.

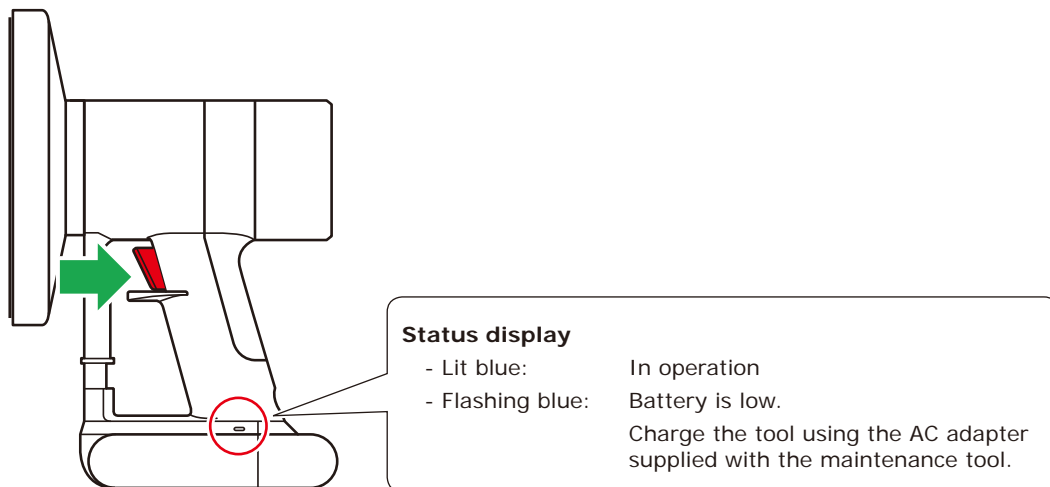

CAUTION

Check that the battery of the tool is fully charged before starting the work. The pixel card will fall if the battery runs out. Lightly hold the pixel card with your hand to prevent it from falling.

- (1) Push the maintenance tool against the pixel card without turning it on.
- (2) Turn the maintenance tool on and then install the pixel card to the cabinet paying attention that the arrows on the back of the pixel card and on the hub board are orientated toward the same direction, and that the two guide pins of the pixel card are aligned to the guide holes of the cabinet (two for each pixel card).
The pixel card is secured by the 14 magnets on each cabinet.

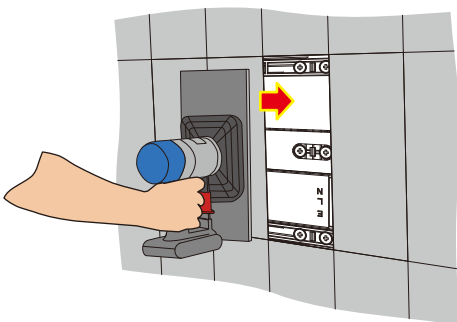

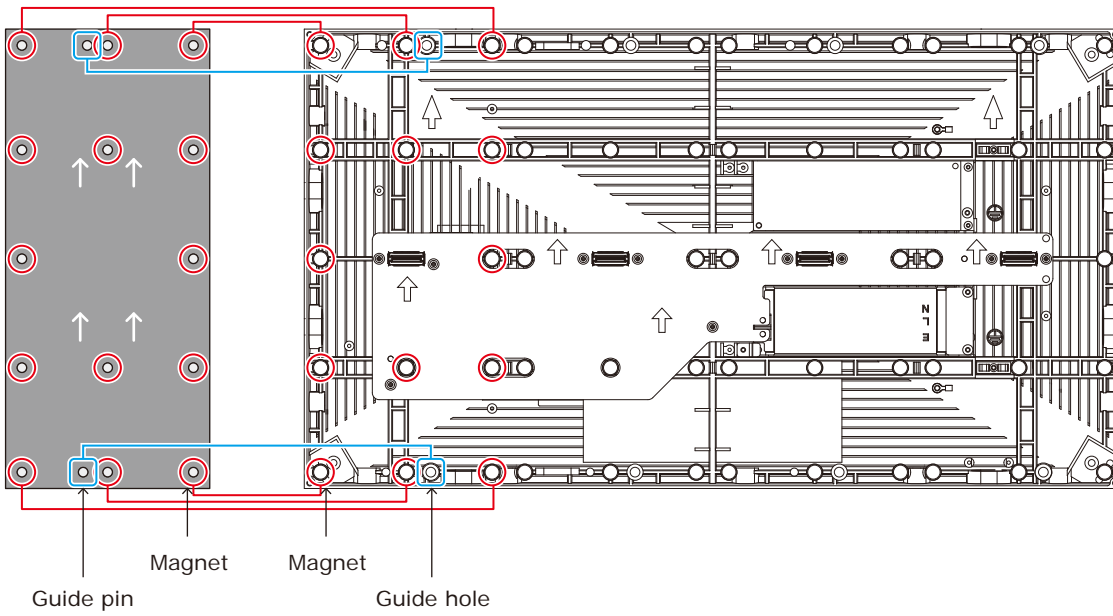

(3) Check that the pixel card stays securely in place and then turn the maintenance tool off.

Screen Configuration

Check that all the connections are completed, and then turn on the LED modules and the LED controller.

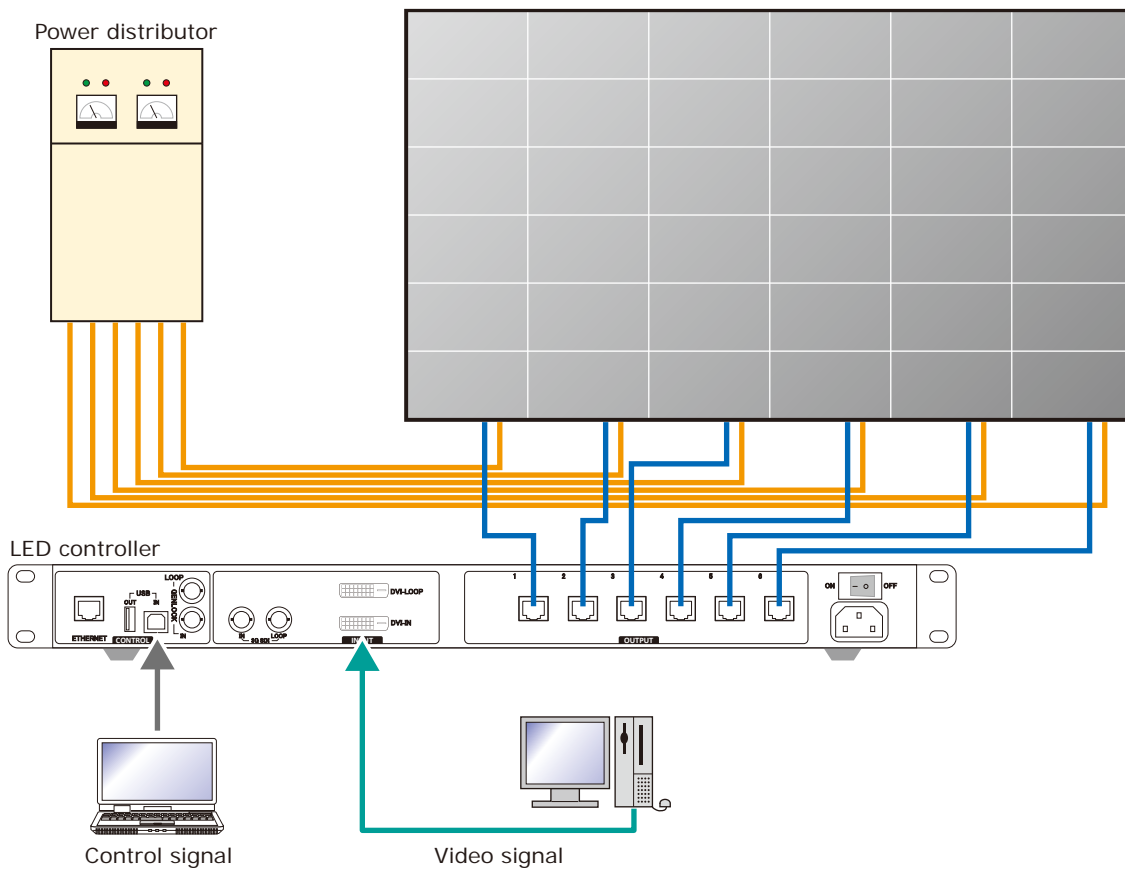

⚠ WARNING

Pay attention to the wire colors of the power cord when connecting the cord. If the cables are not connected correctly, it may lead to a fire or an electrical shock.

- Blue (N)
- Brown (L)
- Yellow green (Ground)

⚠ CAUTION

When using LAN cables of 60 m to 100 m in length, the product may not operate correctly depending on the quality of the cables. In such a case, it is recommended to use optical-fiber cables. Ask a technician or your retailer for more details.

Setting the screen configuration

Perform the setting using the LCT-Mars control software by Novastar.

Log in with the administrator privileges.

Display the login screen as follows: User(U) → Advanced Synchronous System UserLogin(A).

Enter the password ("admin" by default) to log in with the administrator privileges.

To change the password, go to User(U) → Change Password(U) with the administrator privileges.

CAUTION

Do not forget the new password after it has been changed.

Click "Screen Configuration" (a).

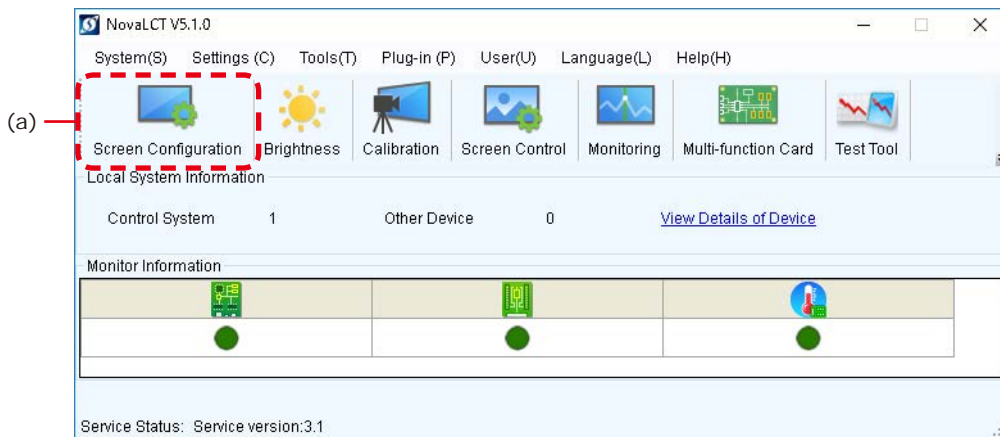

Check the port in "Select Communication Port", and then click the "Next" button (b).

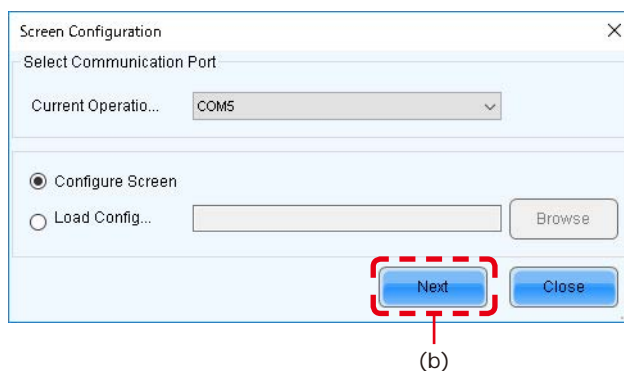

In the Screen Configuration screen that is displayed, select the "Screen Connection" tab (c).

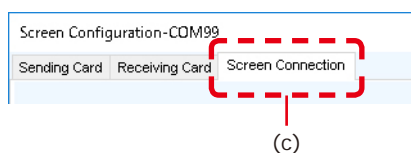

CAUTION

Do not change the settings in the "Receiving Card" tab. Otherwise, the video may not be displayed properly.

Select "Standard Screen" under "Screen Type" (d).

The settings in "Sending Card Number" (e) and "Ethernet Port No." (f) vary depending on the connected LED controller.

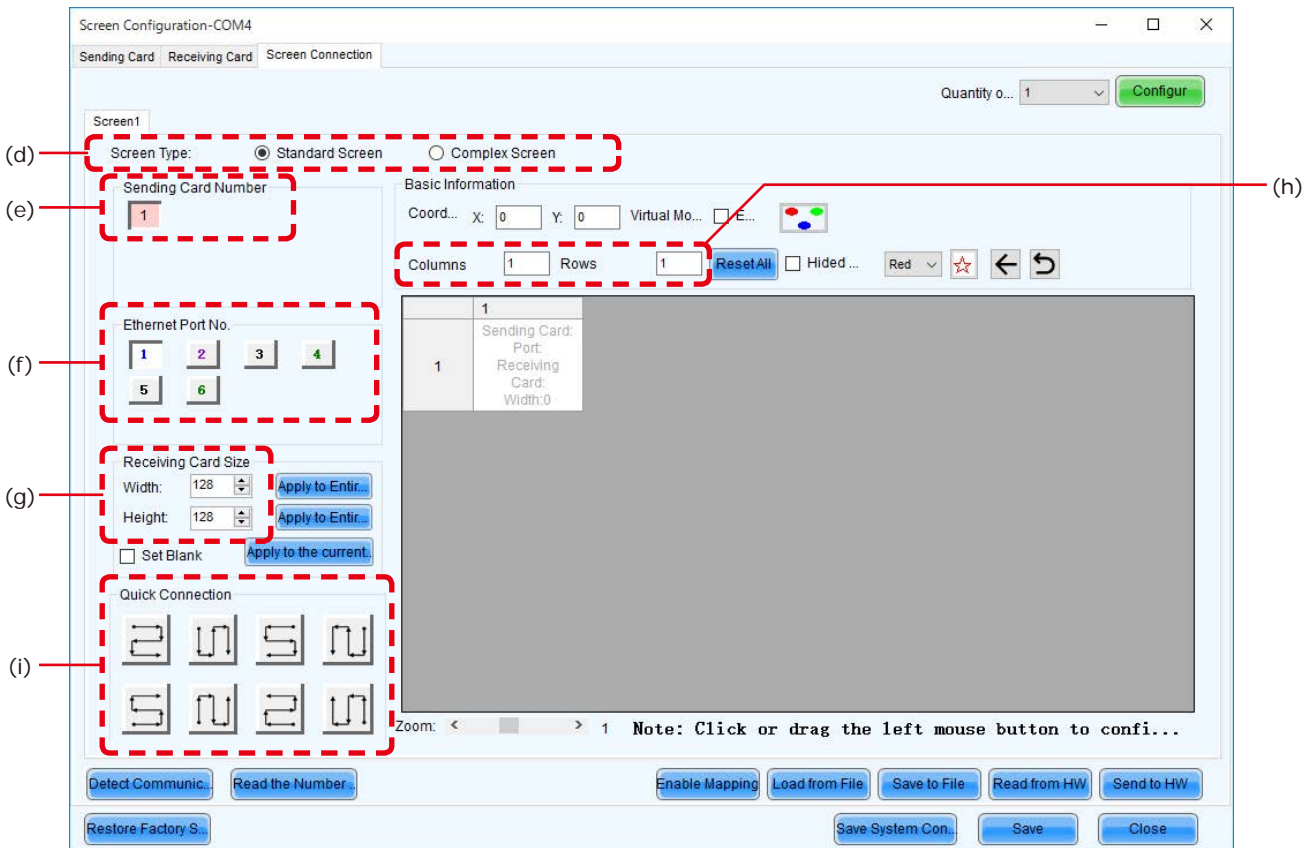

Enter the value in the table below under "Receiving Card Size" (g).

Product name	LED-E012i	LED-E015i	LED-E018i	LED-E025i
Pixel pitch	1.25 mm	1.56 mm	1.88 mm	2.50 mm
Number of displayed pixels (resolution/module)	Width 480 Height 270	Width 384 Height 216	Width 320 Height 180	Width 240 Height 135

[Columns/Rows] Enter the number of installed screens under "Columns/Rows" (h) (the number of vertically installed screens in Columns, and the number of horizontally installed screens in Rows).

[Configuration example]

The setting values are given for the following example where 16 LED-E012i modules (pixel pitch of 1.25 mm) are installed in a 4 (columns) x 4 (rows) configuration.

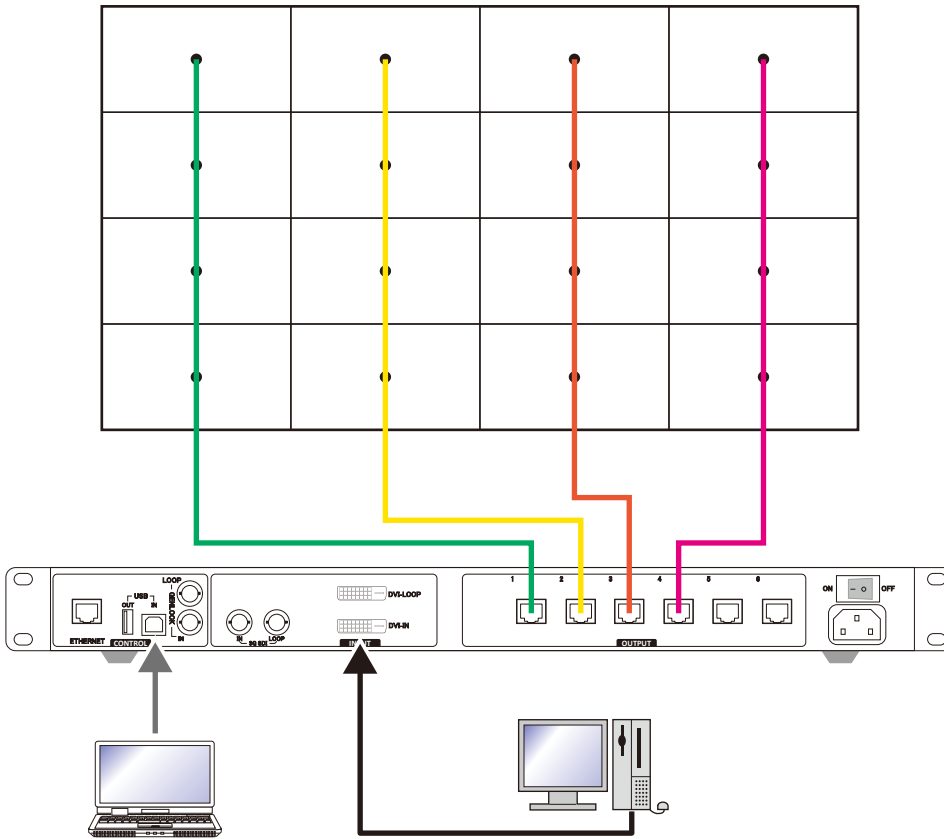

- (1) With a pixel pitch of 1.25 mm, enter Width=480 and Height=270 under "Receiving Card Size" (g). Do not use the buttons located next to the values.

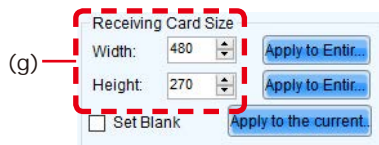

- (2) Since the configuration is 4 (columns) x 4 (rows), enter Columns=4 and Rows=4. A 4 (columns) x 4 (rows) screen configuration is displayed.

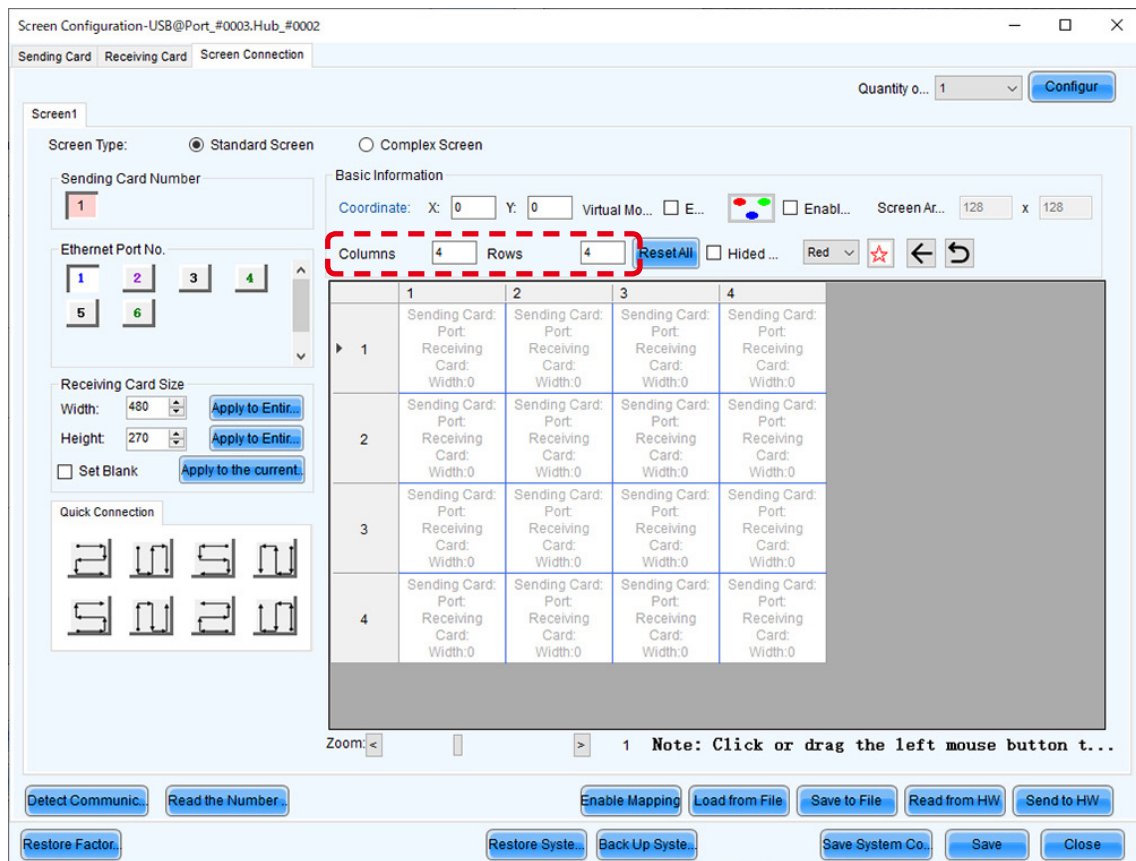

- (3) If multiple LED controllers are used, select the number of the connected LED controllers.
Since only one controller is used in this example, it is not necessary to set "Sending Card Number" (e).
- (4) Configure the connection.

(4)-1 Connecting from bottom to top using multiple ports
The system is connected to port 1 of the LED controller.

Select "1" (port 1) under "Ethernet Port No." (f).

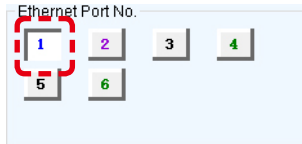

Select the cabinet at the bottom left with the mouse, and then select the other cabinets up to the top cabinet.

Then select Port2 and select the cabinets from the bottom to the top as you did for Port1.

Screen Configuration-USB@Port_#0003.Hub_#0002

Sending Card Receiving Card Screen Connection

Quantity o... 1 **Configure**

Screen1

Screen Type: Standard Screen Complex Screen

Sending Card Number: 1

Ethernet Port No.: 1 2 3 4 5 6

Receiving Card Size
Width: 480 **Apply to Entire...**
Height: 270 **Apply to Entire...**
 Set Blank **Apply to the current.**

Quick Connection

Basic Information
Coordinate: X: 0 Y: 0 Virtual Mo... E... Enabl... Screen Ar... 128 x 128

Columns: 4 Rows: 4 **ResetAll** Hided... Red

	1	2	3	4
1	Sending Card:1 Port:1 Receiving Card:4 Width:480	Sending Card:1 Port:2 Receiving Card:4 Width:480	Sending Card: Port: Receiving Card: Width:0	Sending Card: Port: Receiving Card: Width:0
2	Sending Card:1 Port:1 Receiving Card:3 Width:480	Sending Card:1 Port:2 Receiving Card:3 Width:480	Sending Card: Port: Receiving Card: Width:0	Sending Card: Port: Receiving Card: Width:0
3	Sending Card:1 Port:1 Receiving Card:2 Width:480	Sending Card:1 Port:2 Receiving Card:2 Width:480	Sending Card: Port: Receiving Card: Width:0	Sending Card: Port: Receiving Card: Width:0
4	Sending Card:1 Port:1 Receiving Card:1 Width:480	Sending Card:1 Port:2 Receiving Card:1 Width:480	Sending Card: Port: Receiving Card: Width:0	Sending Card: Port: Receiving Card: Width:0

Zoom: 1 **Note: Click or drag the left mouse button t...**

Detect Communic... **Read the Number...** **Enable Mapping** **Load from File** **Save to File** **Read from HW** **Send to HW**

Restore Factor... **Restore System...** **Back Up System...** **Save System Co...** **Save** **Close**

Follow the same procedure for Port3 and Port4.

Screen Configuration-USB@Port_#0003.Hub_#0002

Sending Card Receiving Card Screen Connection

Quantity o... 1 **Configur...**

Screen1

Screen Type: Standard Screen Complex Screen

Sending Card Number:

Ethernet Port No.:

Receiving Card Size
 Width: **Apply to Entire...**
 Height: **Apply to Entire...**
 Set Blank **Apply to the current.**

Quick Connection

Basic Information
 Coordinate: X: Y: Virtual Mo... E... Enabl... Screen Ar... x

Columns: Rows: **Reset All** Hided... Red ☆ ↶ ↷

	1	2	3	4
1	Sending Card:1 Port:1 Receiving Card:4 Width:480	Sending Card:1 Port:2 Receiving Card:4 Width:480	Sending Card:1 Port:3 Receiving Card:4 Width:480	Sending Card:1 Port:4 Receiving Card:4 Width:480
2	Sending Card:1 Port:1 Receiving Card:3 Width:480	Sending Card:1 Port:2 Receiving Card:3 Width:480	Sending Card:1 Port:3 Receiving Card:3 Width:480	Sending Card:1 Port:4 Receiving Card:3 Width:480
3	Sending Card:1 Port:1 Receiving Card:2 Width:480	Sending Card:1 Port:2 Receiving Card:2 Width:480	Sending Card:1 Port:3 Receiving Card:2 Width:480	Sending Card:1 Port:4 Receiving Card:2 Width:480
4	Sending Card:1 Port:1 Receiving Card:1 Width:480	Sending Card:1 Port:2 Receiving Card:1 Width:480	Sending Card:1 Port:3 Receiving Card:1 Width:480	Sending Card:1 Port:4 Receiving Card:1 Width:480

Zoom: **Note: Click or drag the left mouse button t...**

Detect Communic... **Read the Number...** **Enable Mapping** **Load from File** **Save to File** **Read from HW** **Send to HW**

Restore Factor... **Restore System...** **Back Up System...** **Save System Co...** **Save** **Close**

(4)-2 Connecting all the LED modules using a single LAN cable

The system is connected to port 1 of the LED controller.

Select "1" (port 1) under "Ethernet Port No." (f).

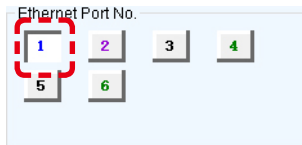

Click (select) the connection pattern under "Quick Connection" (i). Since the modules are connected from the bottom left to the top right in the example, the pattern is as shown in the figure.

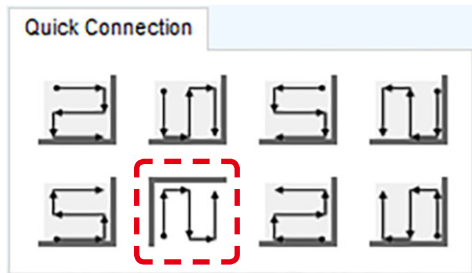

Select all the cabinets from the top left to the bottom right as shown in the figure below.

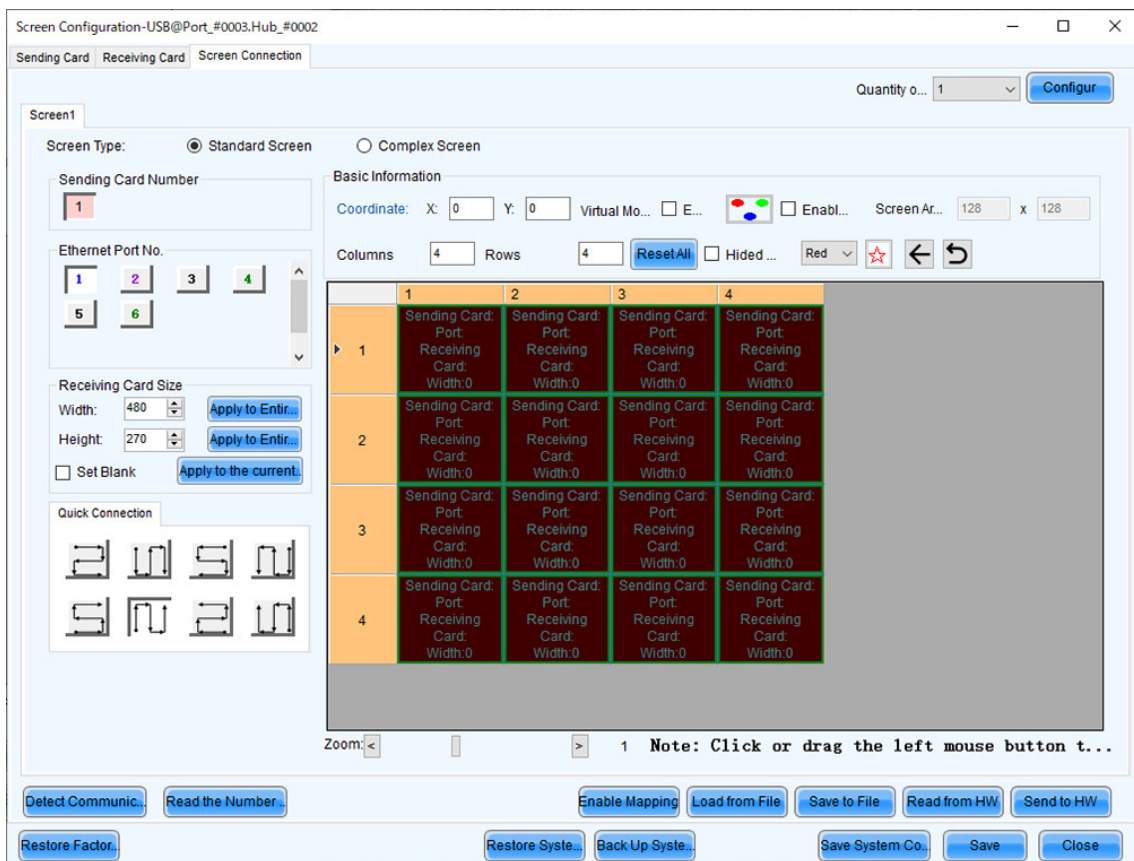

The selection is done automatically to obtain the screen below.

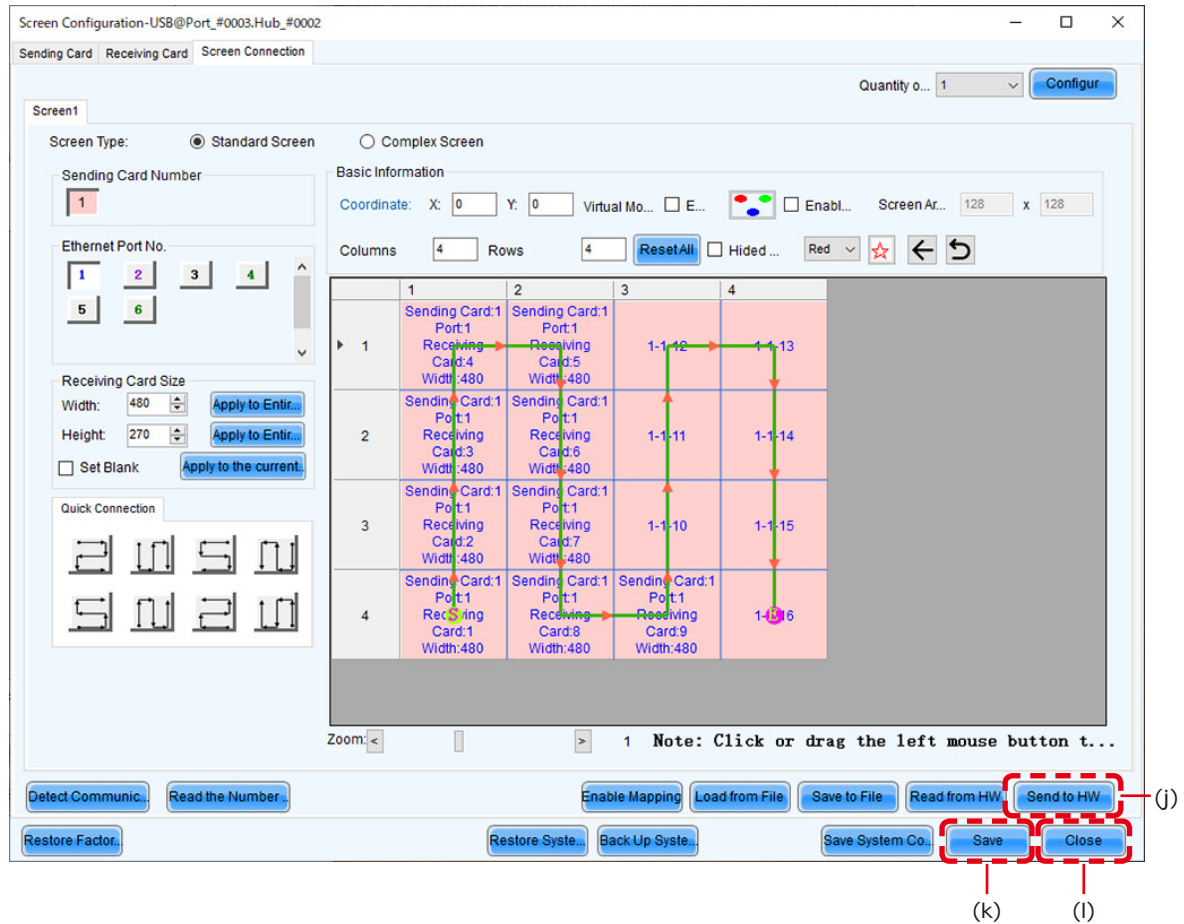

(5) Save the settings.

(a) Click the "Send to HW" button (j). When the dialog box indicating that the process finished successfully is displayed, click OK.

(b) Check that the image is correctly displayed, and then click the "Save" button (k). When the screen indicating that the process finished successfully is displayed, click OK.

The setting of the screen configuration is complete. Click the "Close" button (l) to close the Screen Configuration screen.

Image Setting

You can adjust the brightness, the gamma correction value, and the color temperature.

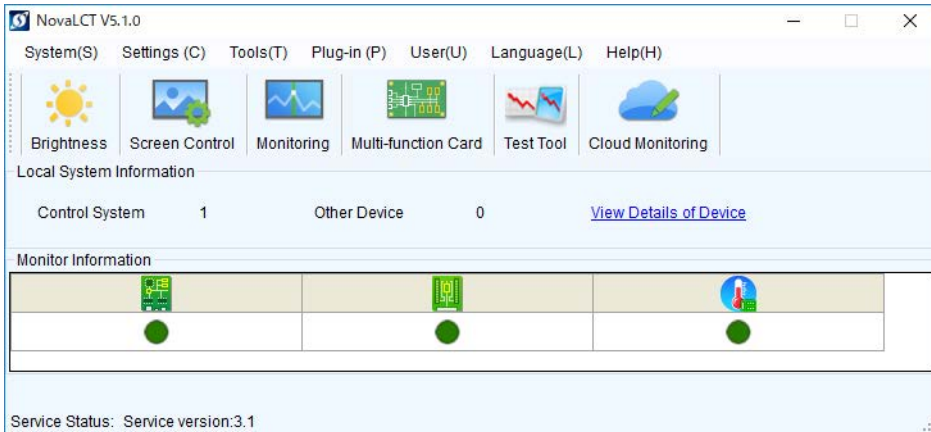

Click "Brightness" on the top screen to display the following window.

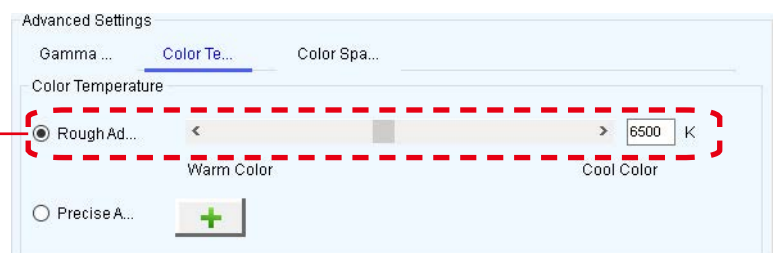
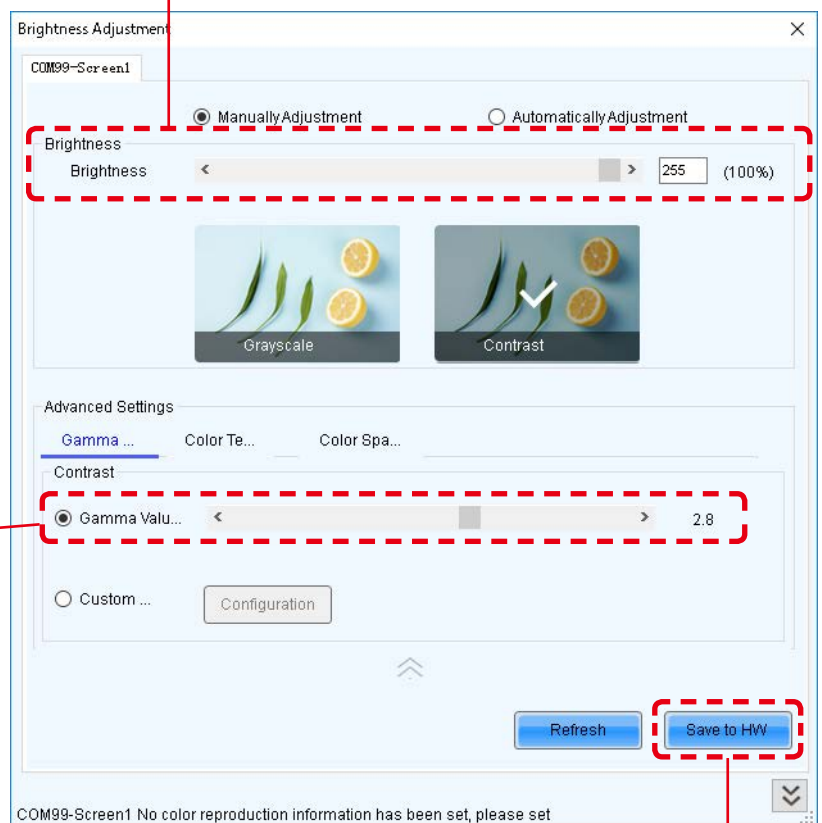
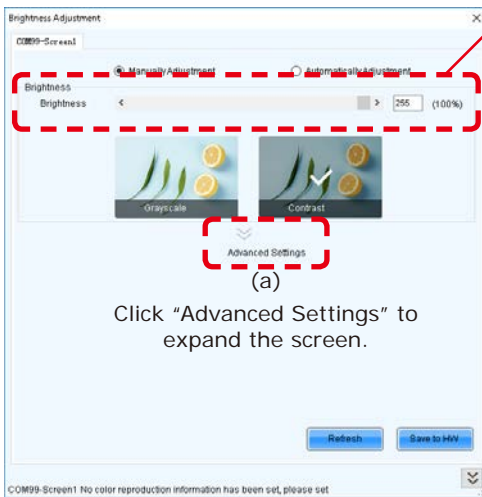

Click "Advanced Settings" (☒) (a) to expand the setting screen.

(1) Brightness

Set the brightness of the screen using the slider (b).
Increasing the value increases the brightness.

(2) Gamma correction

Set the gamma correction value using the slider (c).
Increasing the value makes the dark parts of the screen darker.

(3) Color temperature

Set the color temperature using the slider (d).
Increasing the value makes the colors more bluish, while reducing the value makes the colors more reddish.
When the setting is complete, click the "Save to HW" button to save the settings.

Maintenance

CAUTION

- Disconnect the power supply to the LED modules when performing the maintenance.
- Use the correct screwdriver for the shape of the screws when removing (loosening) or setting (tightening) the screws.
Pay attention not to drop the screws and the other parts you have removed.
Pay attention not to lose the removed screws since they will be reused.

Removing a pixel card

Remove the pixel card using the maintenance tool.

Pull the trigger of the handle to activate the suction function. Release the trigger to stop the suction function.

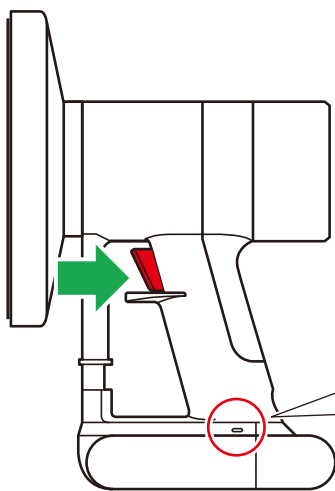

Status display

- Lit blue: In operation
- Flashing blue: Battery is low.
Charge the tool using the AC adapter supplied with the maintenance tool.

CAUTION:

Check that the battery of the maintenance tool is fully charged before starting the work. Pixel card falls if the battery runs out. Hold the pixel card with your hand to support in case it falls.

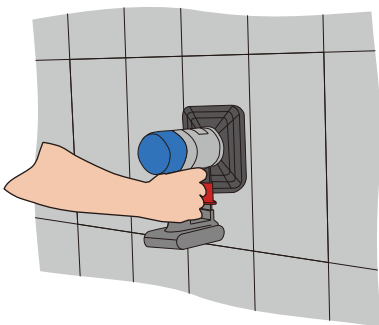

(1) Push the maintenance tool against the pixel card without turning it on.

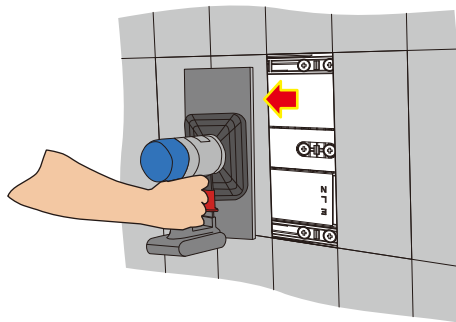

- (2) Turn the maintenance tool on, and then pull it straight toward you to remove the pixel card. Keep the maintenance tool turned on.
- (3) Hold the pixel card, and then turn the maintenance tool off.

CAUTION:

Do not turn the maintenance tool off until you hold the pixel card. Otherwise, the pixel card may fall and break.

Removing the power supply

Disconnect the LAN cable connected to the hub board.

Remove the 10 screws securing the hub board, and then remove the hub board. Then, remove the two screws securing the terminal cover.

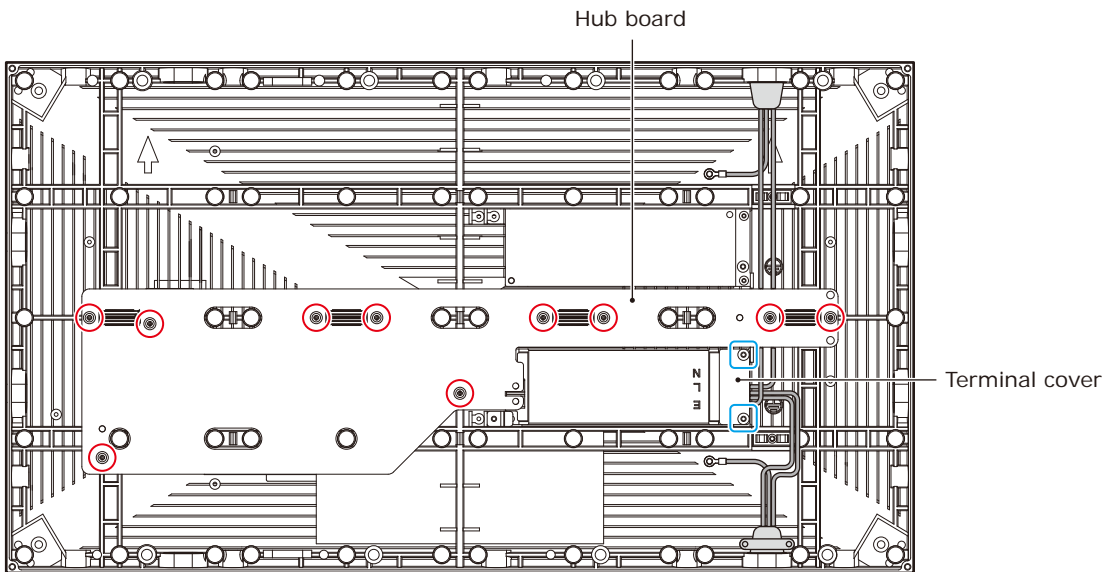

Disconnect the power cables connected to the power supply and remove the two screws securing the power supply, and then remove the power supply.

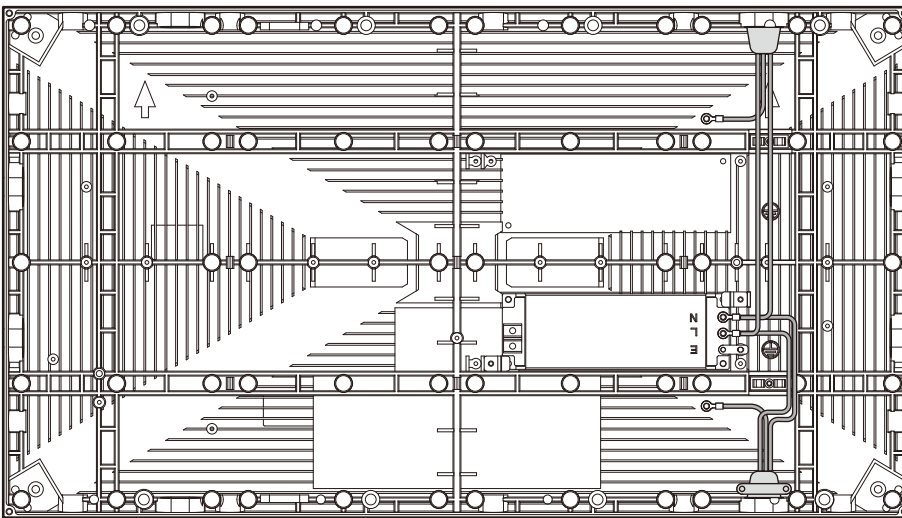

The power supply installation is done by following the same procedure in the reverse order.

Apply some thermal paste on the back of the power unit you will install before installing it. Ask your retailer for more details on the types of thermal paste.

⚠ CAUTION:

When attaching two cables with one screw, place the ring terminals of the cables back to back.

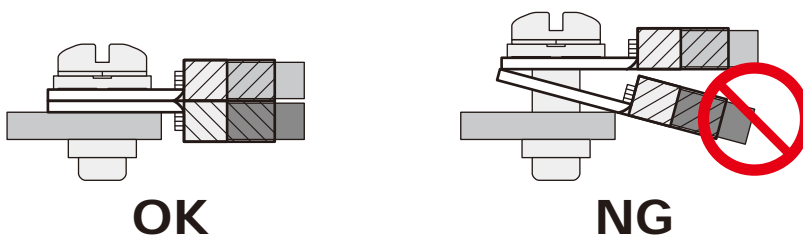

Removing the receiving card

Remove the receiving card from the hub board.

Remove the four screws securing the receiving card, and then remove the receiving card from the hub board.

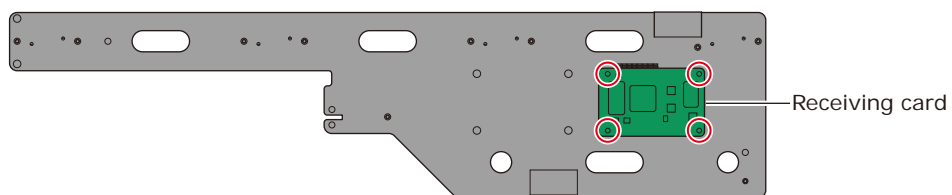

Troubleshooting

1. Display problems

Problem	Solution
Nothing is displayed on all the LED modules.	Check that power is being supplied to the LED modules.
	Check that the LED controller is turned on.
	Check that a video signal is being input to the LED controller.
	Check that a LAN cable is correctly connected between the LED controller and the LED module.
	Check that the brightness is not set to 0% (= not lit).
Nothing is displayed on one LED module.	Check that a LAN cable is correctly connected between the LED controller and the LED module.
	The receiving card inside the LED module may be broken. → Check the status of the LED module by following the procedure in the next section "2 State monitoring using the software".
	The power unit inside the LED module may be broken. → Check the status of the LED module by following the procedure in the next section "2 State monitoring using the software".
No image is displayed on one pixel card.	Check that the contacts of the pixel card are correct (contacts of the hub board).
	The pixel card may be broken. Replace it with a spare pixel card.
Control (communication) is not possible.	Check that the communication cable is correctly connected between the computer and the LED controller.
	Check that the LED controller is turned on.
	If the communication cable is a USB cable, check that the device driver runs correctly.

2. State monitoring using the software

In case of a problem, you will be able to determine the location where it occurred by monitoring the state of the system.

2-1 Display under normal conditions

The display is green under normal conditions.

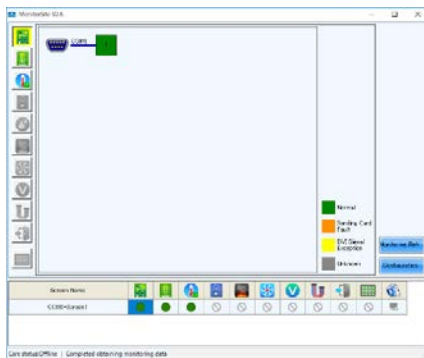
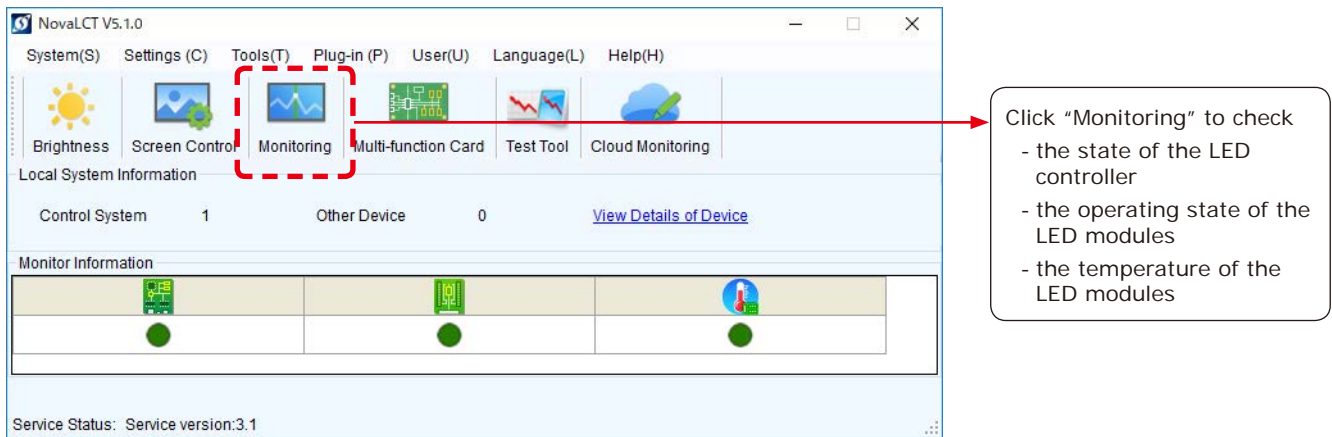

State of the LED controller

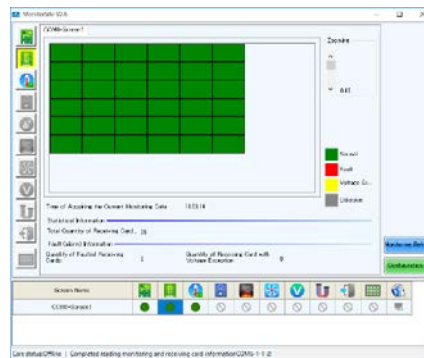

State of the LED modules

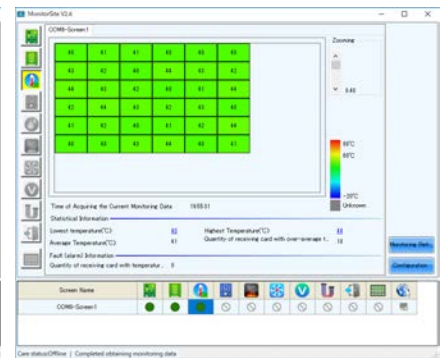

Temperature of the LED modules

2-2 Display under abnormal conditions

(1) Problem with the input signal to the LED controller

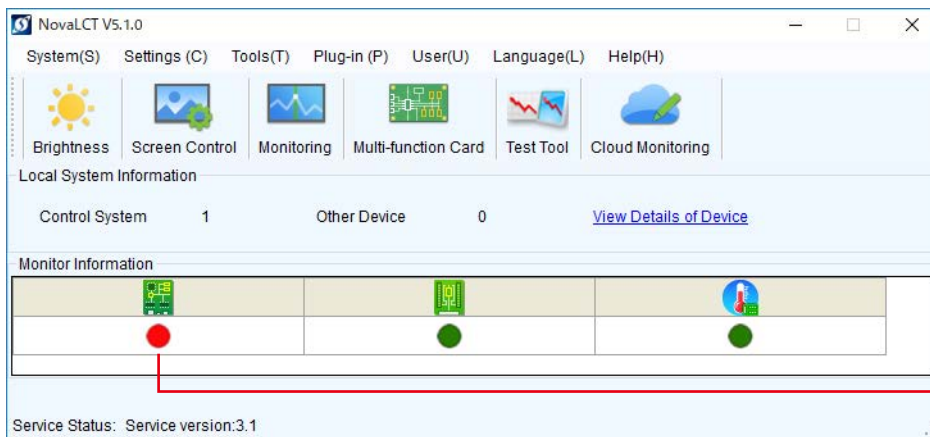

When the display is red, there is a problem with the LED controller.

To display more details, click "Monitoring", and then click "Sending card" on the screen that is displayed.

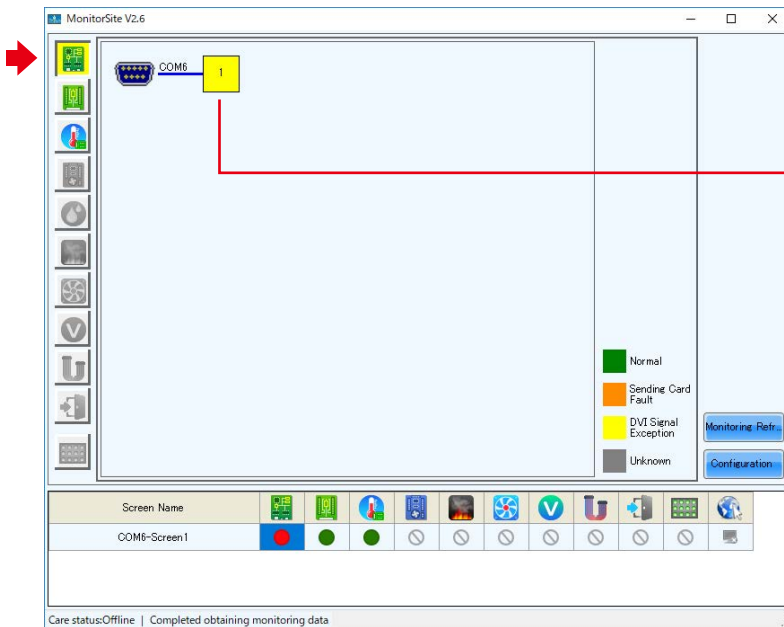

No video signal is being input to the LED controller.

- Check that the LAN cable is connected.
- Check that a video signal is being output from the video output equipment.
- If multiple signals are being input to the LED controller, check the input settings of the LED controller.

(2) Problem with the LED modules

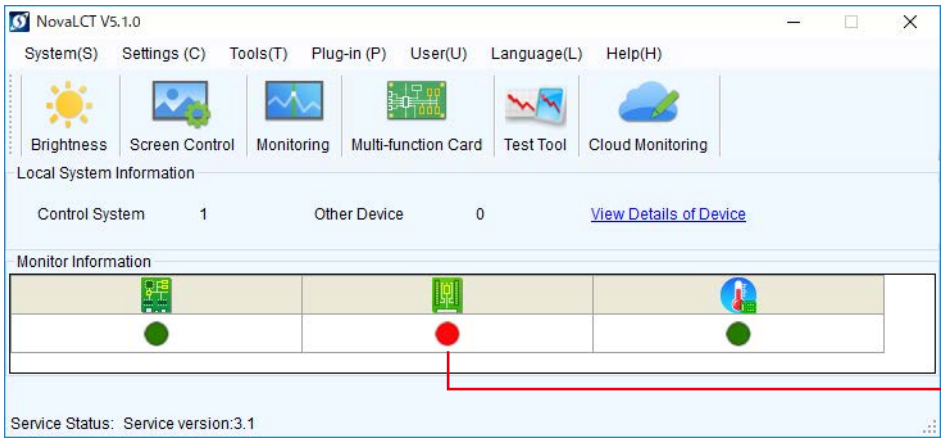

When the display is red, there is a problem with the LED module operation.

To display more details, click "Monitoring", and then click "Receiving card" on the screen that is displayed.

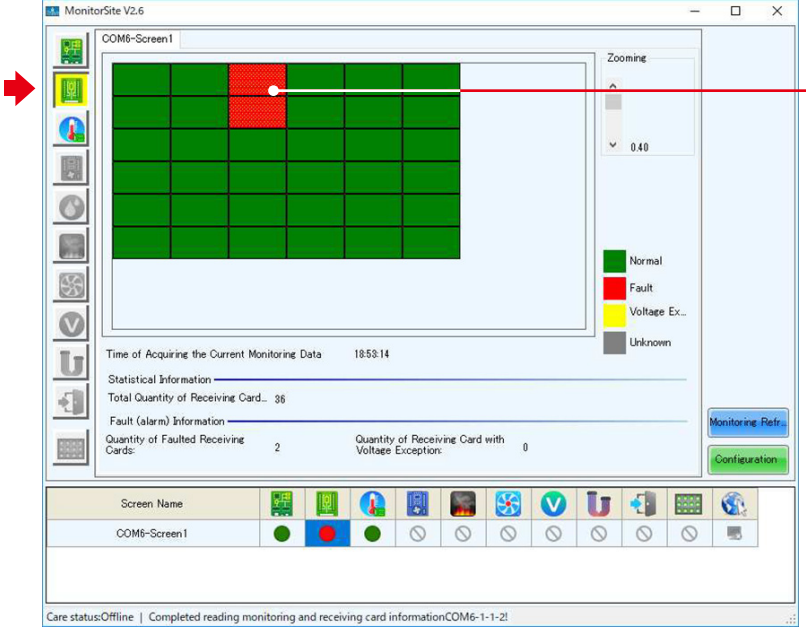

In the example shown on the left, the following problems must be considered.

- Signal loss between the screen of the 1st row 3rd column and the screen of the 1st row 2nd column
→ Check the LAN cable.
- Problem with the power unit of the screen of the 1st row 2nd column
- Problem with the receiving card of the screen of the 1st row 2nd column.
→ Check that the receiving card is securely connected.

With the connection shown in the figure below.

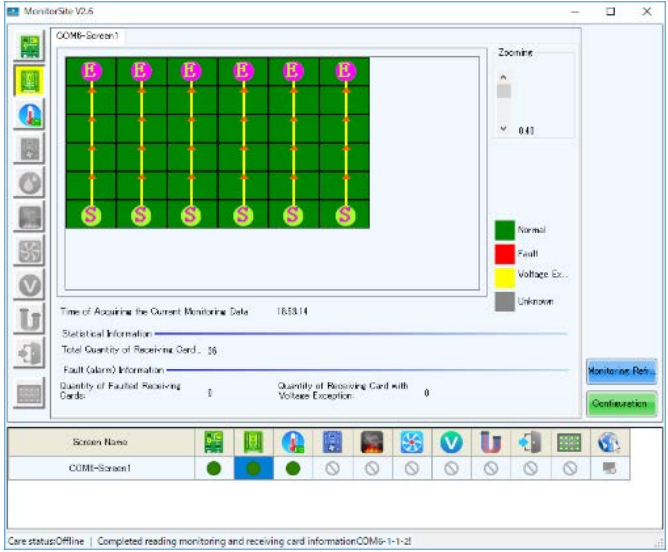

(3) Problem with the internal temperature of the LED modules

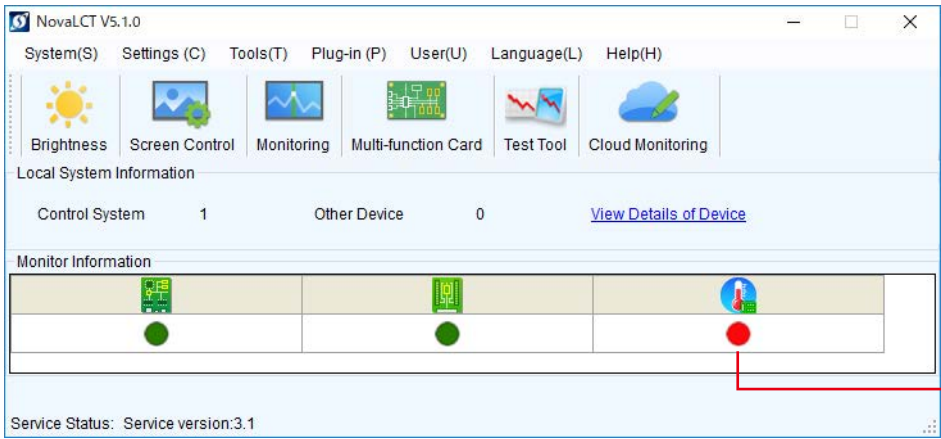

There is a problem with the LED module operation.

To display more details, click "Monitoring", and then click "Temperature" on the screen that is displayed.

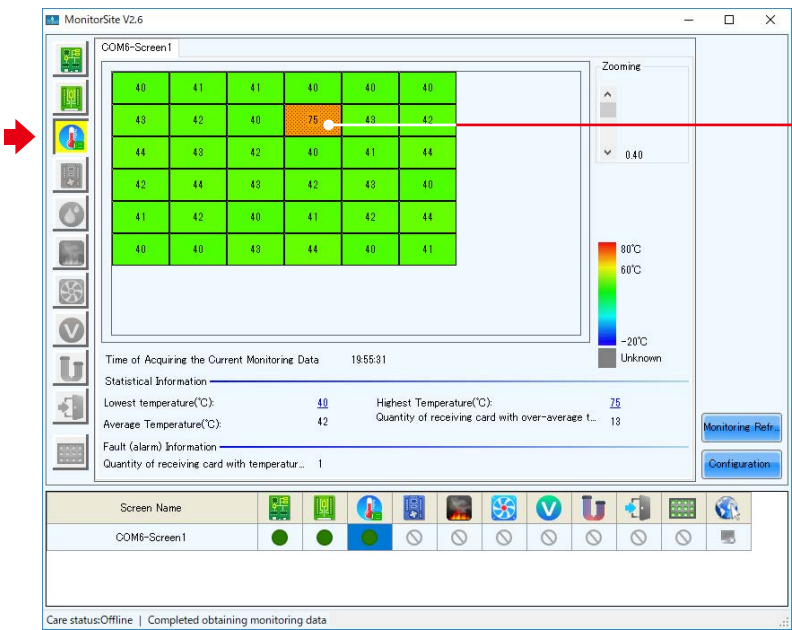

The LED modules with a high temperature are displayed in warm colors.
 Since the internal temperature is high, decrease the brightness setting.
 If changing the brightness setting could not solve the problem, contact your retailer or the Customer Service.

(4) Communication problem

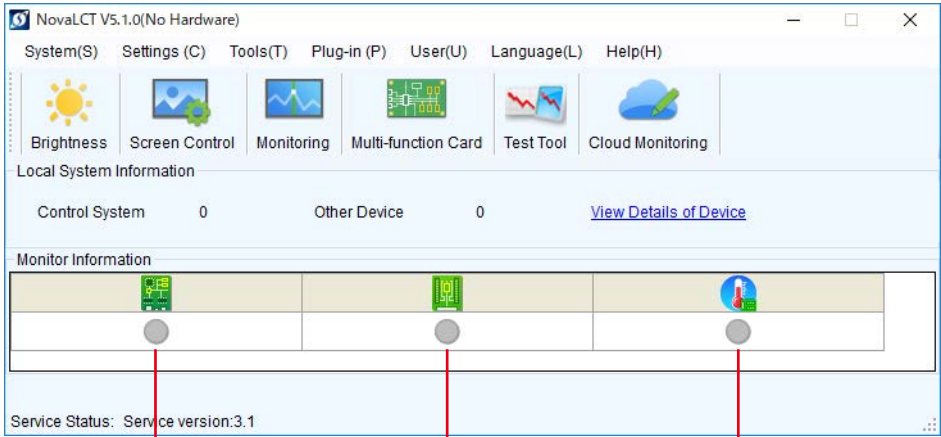

When the display is grey, the communication is not established.

- Check that the USB cable is connected.
- Check that the LED controller is turned on.

Specifications

Models for indoor use

		LED-E012i-108	LED-E015i-135	LED-E018i-162	LED-E025i-217	LED-E012i-217
Module		LED-E012i 4x4	LED-E015i 5x5	LED-E018i 6x6	LED-E025i 8x8	LED-E012i 8x8
LED configuration		3-in-1 SMD				
Pixel pitch		1.25 mm	1.56 mm	1.88 mm	2.50 mm	1.25 mm
Number of displayed pixels (resolution/module)		1920 × 1080	1920 × 1080	1920 × 1080	1920 × 1080	3840 × 2160
Brightness		600 cd/m ²	600 cd/m ²	800 cd/m ²	1000 cd/m ²	600 cd/m ²
Contrast ratio		5000:1	4000:1	5000:1	7000:1	5000:1
Brightness adjustment range		0 to 100% (256 increments)				
Gamma correction		1.0 to 4.0 (default setting: 2.8)				
Color temperature		3000 K to 9500 K (default setting: 6500 K)				
Viewing angle		Up 80°, Down 80°, Left 85°, Right 85°	Up 70°, Down 70°, Left 70°, Right 70°	Up 70°, Down 70°, Left 70°, Right 70°	Up 80°, Down 75°, Left 80°, Right 80°	Up 80°, Down 80°, Left 85°, Right 85°
Signal interface	Signal input	1 × RJ-45				
	Signal output	1 × RJ-45				
Power supply		100 V AC to 240 V AC, 50 Hz/60 Hz				
Power consumption (all white, 100% brightness)		2000 W	3125 W	4500 W	8000 W	8000 W
Ingress protection		Front IP 20 / Back IP 20				
Maintenance		Front				
Dimensions		2412 × 1456 × 50 mm	3012 × 1793.5 × 50 mm	3612 × 2131 × 50 mm	4812 × 2806 × 50 mm	4812 × 2806 × 50 mm
Weight		89.2 kg	134.5 kg	189.2 kg	342.8 kg	342.8 kg
Operating environment	Temperature	-20 to 40°C				
	Humidity	10% to 80% (without condensation)				
	Altitude	No more than 5000 m				
Storage environment	Temperature	-20 to 45°C				
	Humidity	10% to 85% (without condensation)				

Specifications are subject to change without notice.

Diagram

LED-E012i / LED-E015i / LED-E018i / LED-E025i

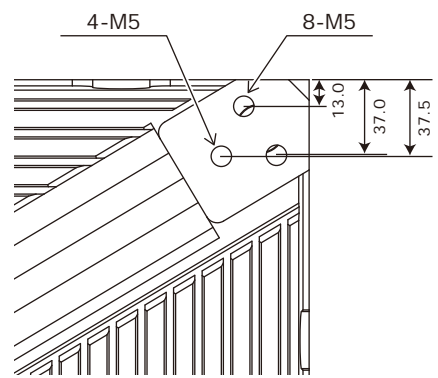
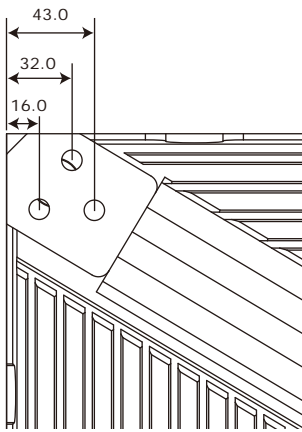
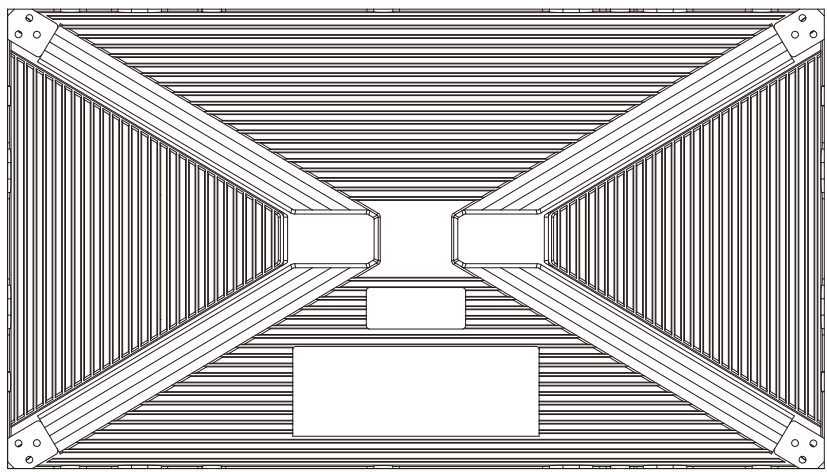
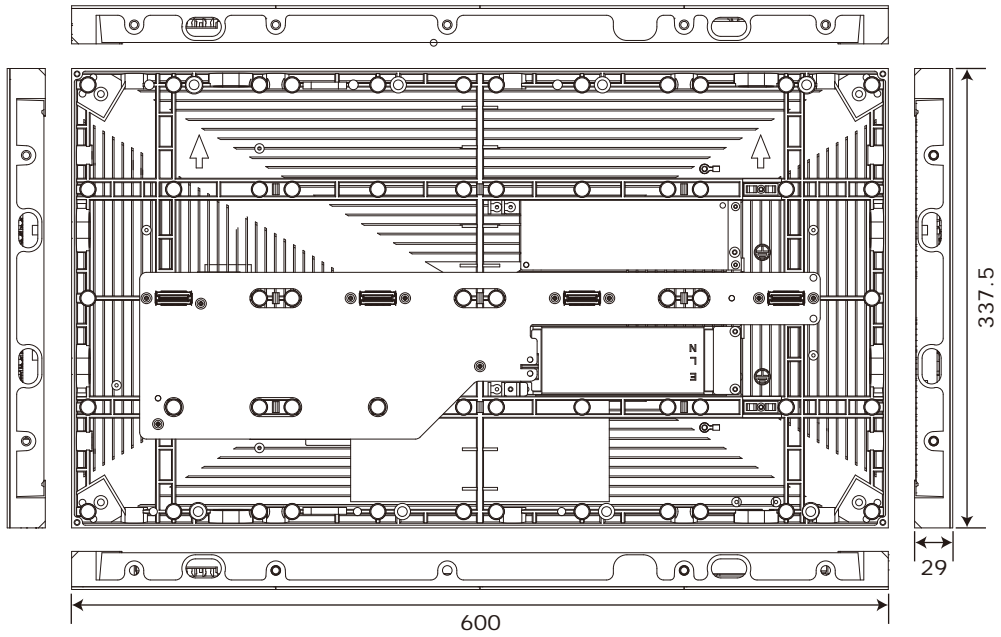

(Unit: mm)

LED-E012i / LED-E015i / LED-E018i / LED-E025i Cabinet alignment bracket

