

# DC193 Document Camera

## User Manual - English

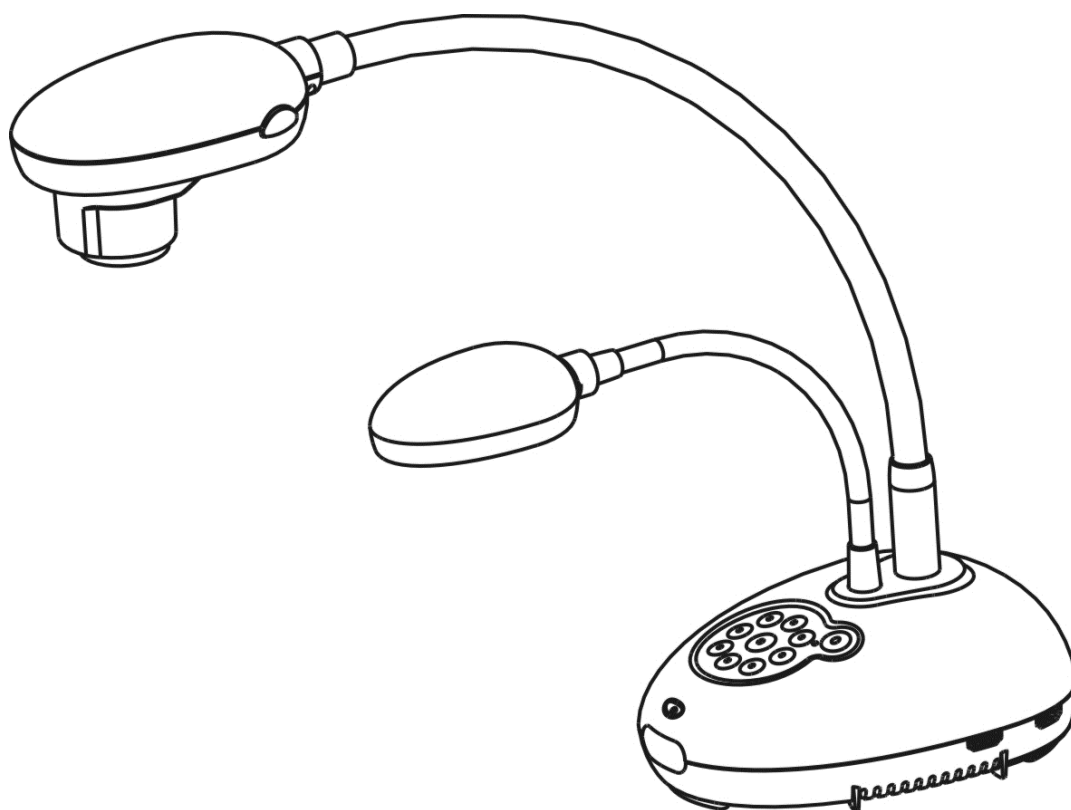

### [Important]

To download the latest version of Quick Start Guide, multilingual user manual, software, or driver, etc., please visit Lumens  
<http://www.MyLumens.com/goto.htm>

# Table of Contents

<b>Copyright Information</b> .....	<b>3</b>
<b>Chapter 1 Safety Instructions</b> .....	<b>4</b>
Precautions .....	5
FCC Warning .....	5
EN55022 (CE Radiation) Warning .....	5
<b>Chapter 2 Package Contents</b> .....	<b>7</b>
<b>Chapter 3 Product Overview</b> .....	<b>8</b>
3.1 Relative position of the presenter and document .....	9
<b>Chapter 4 Installation and Connections</b> .....	<b>10</b>
4.1 System diagram .....	10
4.2 Installation and setup .....	11
4.3 Connecting to a projector or monitor .....	11
4.4 Connecting to an HDTV .....	12
4.5 Connecting to a computer and use Lumens™ software .....	12
4.6 Connecting to a computer and projector or monitor simultaneously .....	13
4.7 Connecting to a computer and USB disk simultaneously .....	13
4.8 Connecting to an Interactive Whiteboard (IWB) .....	14
4.9 Connecting to a speaker .....	14
4.10 Connecting to a computer with RS232 .....	15
4.11 Connecting to a TV .....	15
4.12 Full connectivity including USB .....	16
4.13 Installing application software .....	16
<b>Chapter 5 Start Using</b> .....	<b>17</b>
<b>Chapter 6 Control Panel/Remote Control and Setting Menu</b> .....	<b>18</b>
6.1 Functions of control panel and remote control .....	18
6.2 Setting menu .....	20
<b>Chapter 7 Descriptions of Major Functions</b> .....	<b>26</b>
7.1 I would like to automatically adjust the image to have the best brightness and focusing performance .....	26
7.2 I would like to switch image sources .....	26
7.3 I would like to switch the image mode .....	26
7.4 I would like to make text clearer and photos more colorful .....	26
7.5 I would like to zoom in/out images .....	27

7.6	I would like to use the auto focus .....	27
7.7	I would like to adjust the brightness .....	27
7.8	I would like to turn on/off the lamp.....	27
7.9	I would like to freeze images.....	27
7.10	I would like to rotate the image.....	28
7.11	I would like to capture images.....	28
7.12	I would like to record images.....	29
7.13	I would like to view captured/recorded images .....	30
7.14	I would like to delete the captured/recorded images.....	31
7.15	I would like to automatically delete the stored images whenever it is turned off (Auto Erase) .....	31
7.16	I would like to enlarge a part of the image (PAN) .....	31
7.17	I would like to use the MASK and Spotlight function .....	32
7.18	I would like to play the slides (Slide Show) .....	33
7.19	I would like to compare images (compare live images with stored image files (PIP)) .....	33
7.20	I would like to reduce the image noise (Projector Type).....	34
7.21	I would like to resume the factory default setting (Factory Reset) .....	35
7.22	I would like to change the power on image .....	35
7.23	Computer-related functions .....	35
<b>Chapter 8 Connecting to Microscope .....</b>		<b>37</b>
<b>Chapter 9 DIP switch setting .....</b>		<b>38</b>
9.1	Connecting to a projector or monitor .....	38
9.2	Connecting to a TV.....	39
<b>Chapter 10 Troubleshooting .....</b>		<b>40</b>

# Copyright Information

---

Copyrights © Lumens Digital Optics Inc. all rights reserved.

Lumens is a trademark that is currently being registered by Lumens Digital Optics Inc.

Copying, reproducing or transmitting this file is not allowed if a license is not provided by Lumens Digital Optics Inc. unless copying this file is for the purpose of backup after purchasing this product.

In order to keep improving the product, Lumens Digital Optics Inc. hereby reserves the right to make changes to product specifications without prior notice. The information in this file is subject to change without prior notice.

To fully explain or describe how this product should be used, this manual may refer to names of other products or companies without any intention of infringement.

Disclaimer of warranties: Lumens Digital Optics Inc. is neither responsible for any possible technological, editorial errors or omissions, nor responsible for any incidental or related damages arising from providing this file, using, or operating this product.

# Chapter 1 Safety Instructions

---

Always follow these safety instructions when setting up and using the Document Camera:

1. Do not place Document Camera in tilted position.
2. Do not place the Document Camera on an unstable trolley, stand or table.
3. Do not use the Document Camera near water or source of heat.
4. Use attachments only as recommended.
5. Use the type of power source indicated on the Document Camera. If you are not sure of the type of power available, consult your dealer or local electricity company for advice.
6. Place the Document Camera on a place that it can be unplugged easily.
7. Always take the following precautions when handling the plug. Failure to do so may result in sparks or fire.
  - Ensure the plug is free of dust before inserting it into a socket.
  - Ensure that the plug is inserted into the socket securely.
8. Do not overload wall sockets, extension cords or multi-way plug boards as this may cause fire or electric shock.
9. Do not place the Document Camera where the cord can be stepped on as this may result in fraying or damage to the lead or the plug.
10. Unplug the Document Camera from the wall socket before cleaning. Use a damp cloth for cleaning. Do not use liquid or aerosol cleaners.
11. Do not block the slots and openings in the Document Camera case. They provide ventilation and prevent the Document Camera from overheating. Do not place the Document Camera on a sofa, rug or other soft surface or in a built-in installation unless proper ventilation is provided.
12. Never push objects of any kind through cabinet slots. Never allow liquid of any kind to spill into the Document Camera.
13. Except as specifically instructed in this User Manual, do not attempt to operate this product by yourself. Opening or removing covers may expose you to dangerous voltages and other hazards. Refer all servicing to licensed service personnel.
14. Unplug the Document Camera during thunderstorms or if it is not going to be used for an extended period. Do not place the Document Camera or remote control on top of vibrating equipment or heated objects such as a car, etc.
15. Unplug the Document Camera from the wall outlet and refer serving to licensed service personnel when the following situations happen:
  - If the power cord or plug becomes damaged or frayed.
  - If liquid is spilled into it or the Document Camera has been exposed to rain or water.





**<Note> Using an incorrect battery type in the remote control may result in breakdown. Follow local instructions on how to dispose of used batteries.**

## ■ Precautions

**Warning: To reduce the risk of fire or electric shock, do not expose this appliance to rain or moisture.**

This Document Camera has a 3-wire AC line Plug. This is a safety feature to ensure that the plug will fit into the power outlet. Do not try to disable this safety feature.

If the Document Camera will not be used for an extended time, unplug it from the power socket.

	<p>Note</p> <p><b>Risk of Electric Shock</b> Please do not open it by yourself</p>	
<p>Caution: To reduce the risk of electric shock, do not remove cover (or back). No user-serviceable parts inside. Refer servicing to licensed service personnel.</p>		
	<p>This symbol indicates that this equipment may contain dangerous voltage which could cause electric shock.</p>	
		<p>This symbol indicates that there are important operating and maintenance instructions in this User Manual with this unit.</p>

## ■ FCC Warning

This Document Camera has been tested and found to comply with the limits for a Class A computer device, pursuant to Article 15-J of FCC Rules. These limits are designed to provide reasonable protection against harmful interference in a commercial installation.

This digital apparatus does not exceed the Class A limits for radio noise emissions from digital apparatus as set out in the interference-causing equipment standard entitled "Digital Apparatus," ICES-003 of Industry Canada.

Cet appareil numérique respecte les limites de bruits radioélectriques applicables aux appareils numériques de Classe A prescrites dans la norme sur le matériel brouilleur: "Appareils Numériques," NMB-003 édictée par l'Industrie.

## ■ EN55022 (CE Radiation) Warning

This product is intended for use in a commercial, industrial, or educational environment. It is not intended for residential use.

This is a Class A product. In a residential environment it may cause radio interference, in which case the user may be required to take adequate measures. The typical use is in a conference room, reception room or hall.

# Chapter 2 Package Contents

DC193

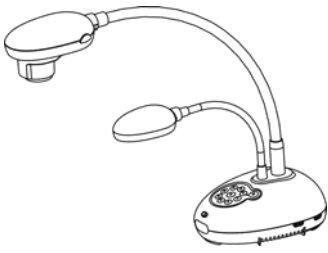

Quick Start Guide

(For download of other language versions, please visit Lumens website)

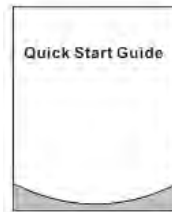

4-Steps Card



VGA cable



USB cable

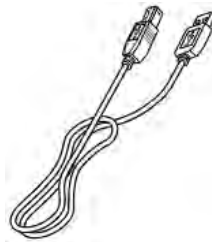

Power cord



Appearance may vary depending on country/region

HDMI Cable \* 2



Remote control



Remote Control Holder

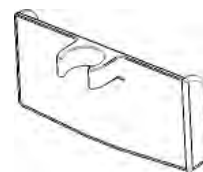

Accessory Pouch



Microscope Adapter

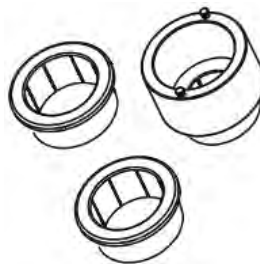



# Chapter 3 Product Overview

---

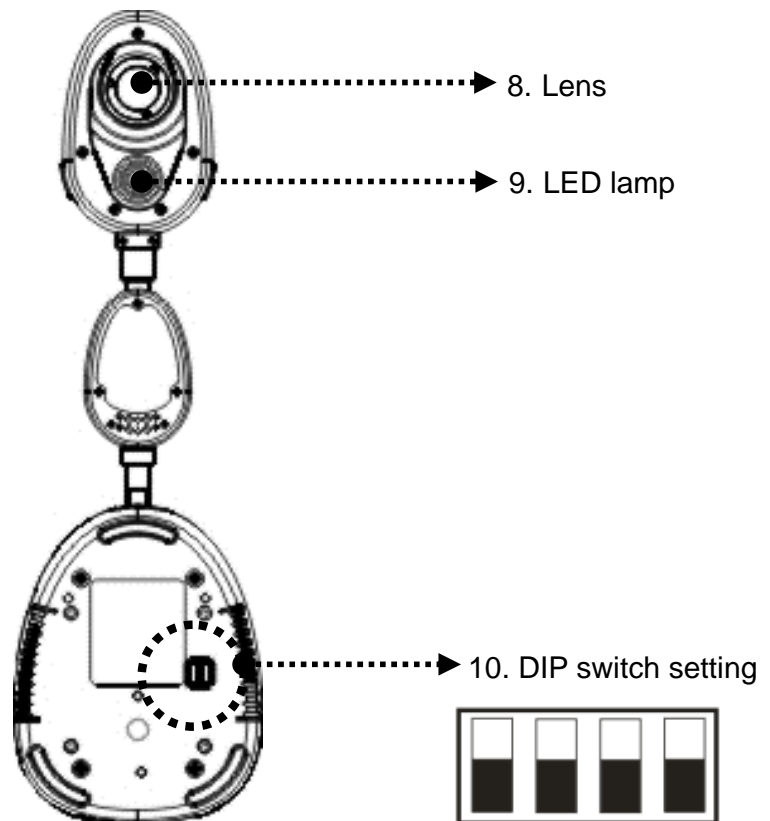
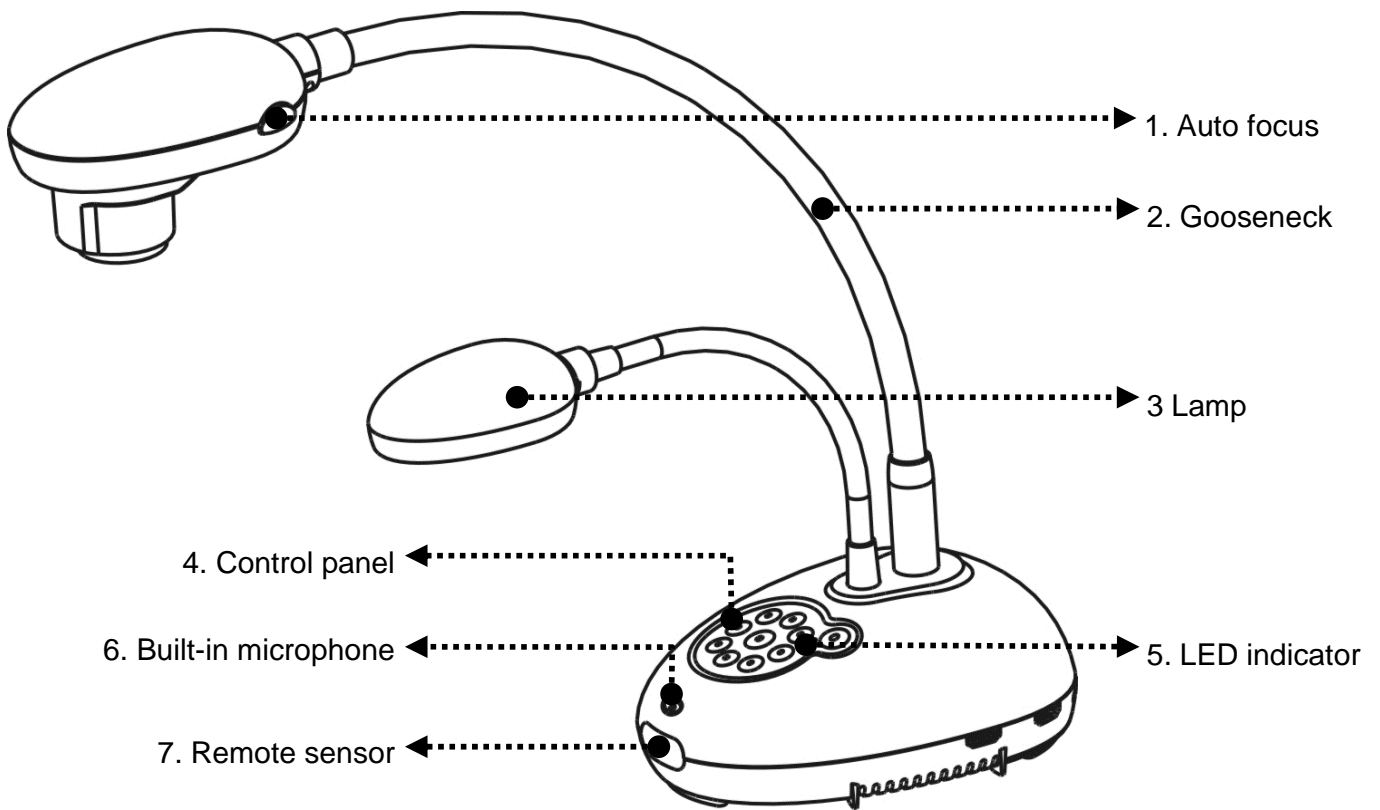

### 3.1 Relative position of the presenter and document

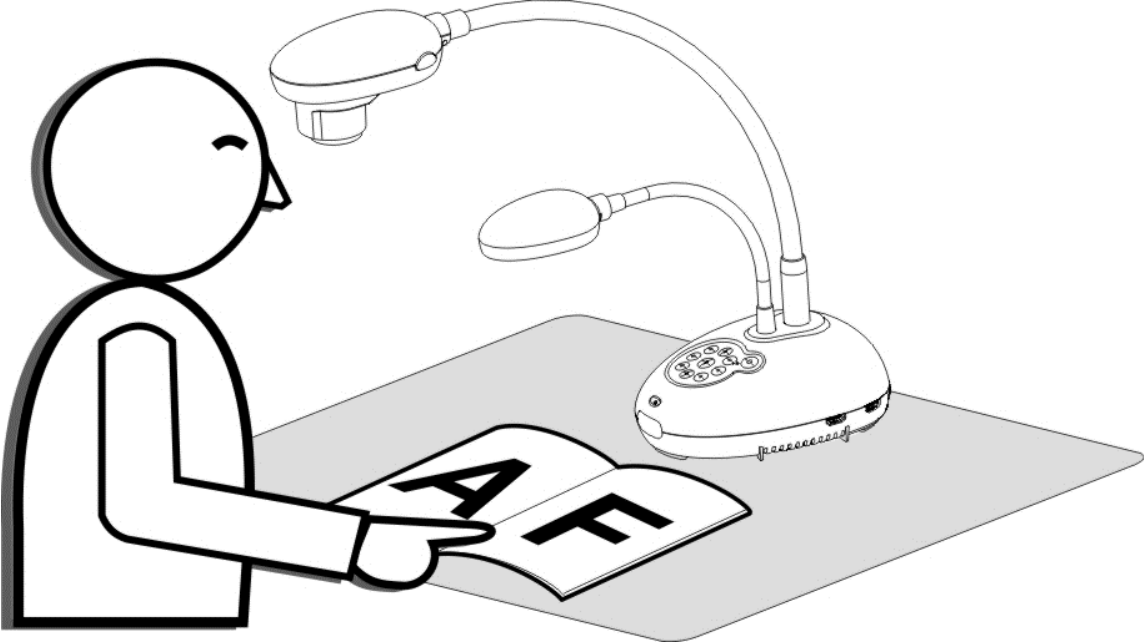

# Chapter 4 Installation and Connections

## 4.1 System diagram

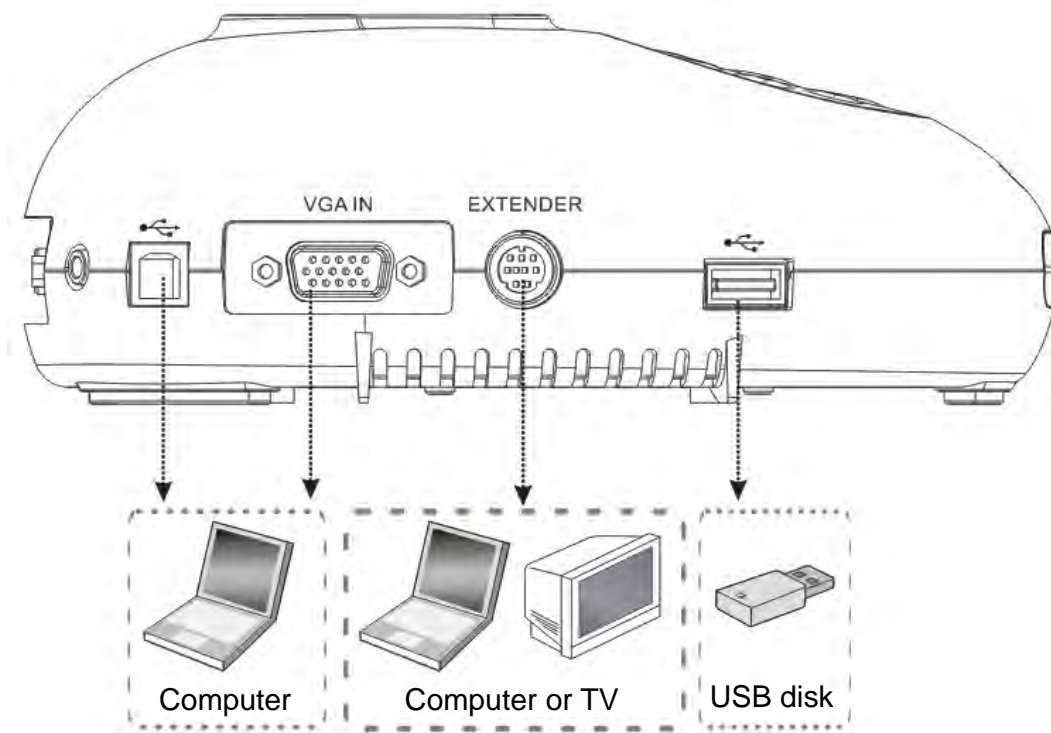
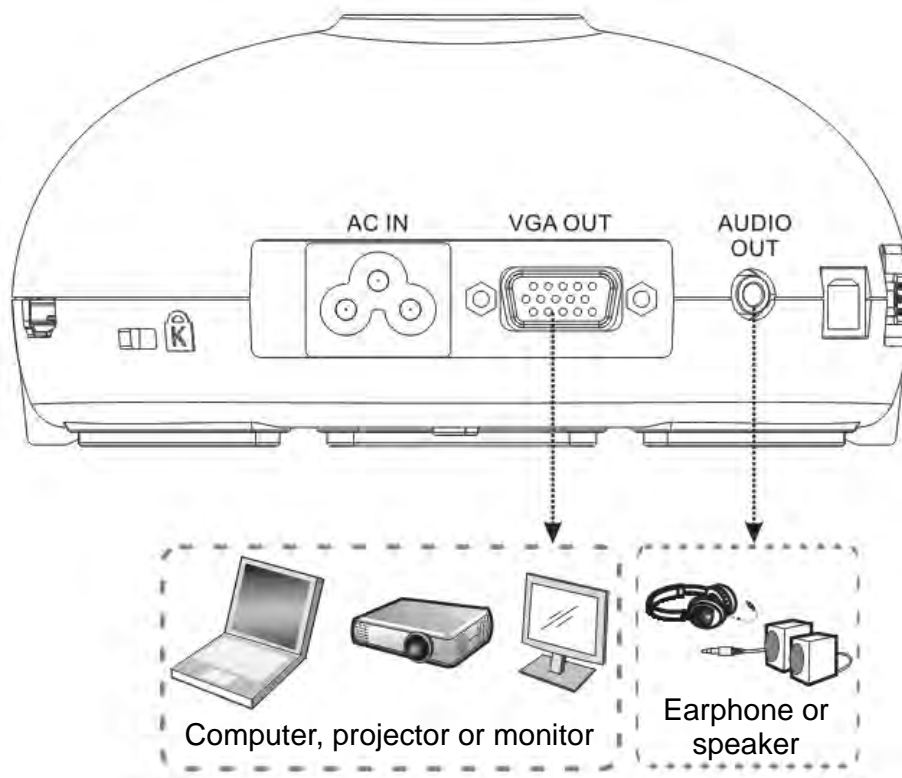

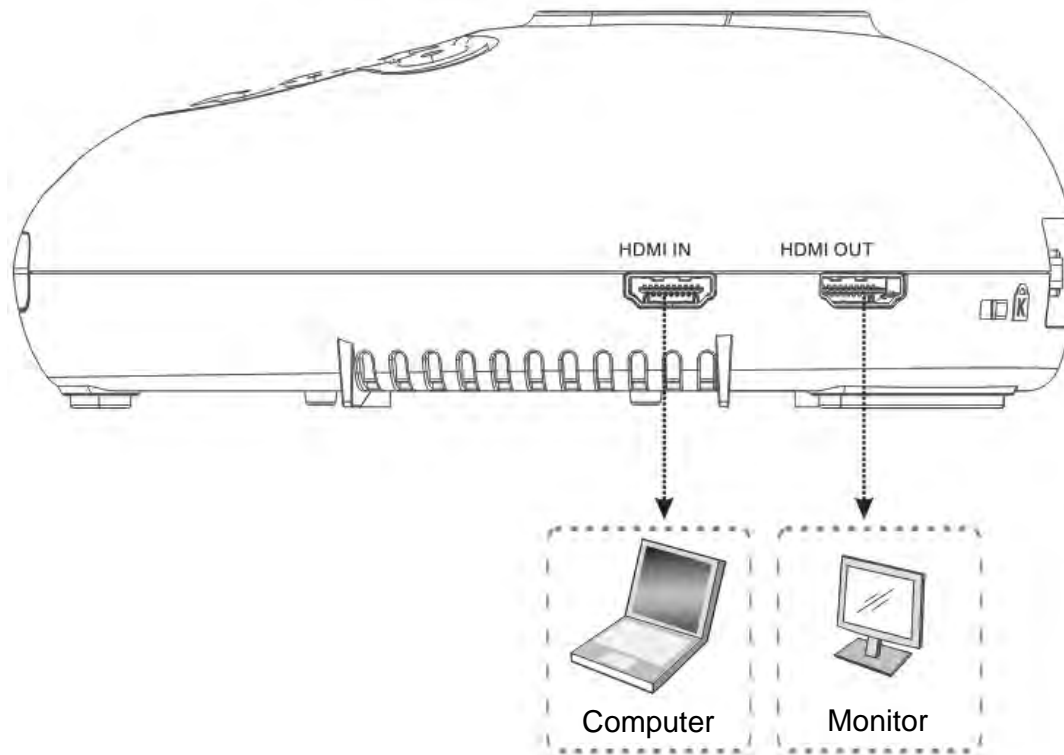

## 4.2 Installation and setup

1. Please set up the DIP switch setting first. Refer to [Chapter 9 DIP Switch Setting](#).

## 4.3 Connecting to a projector or monitor

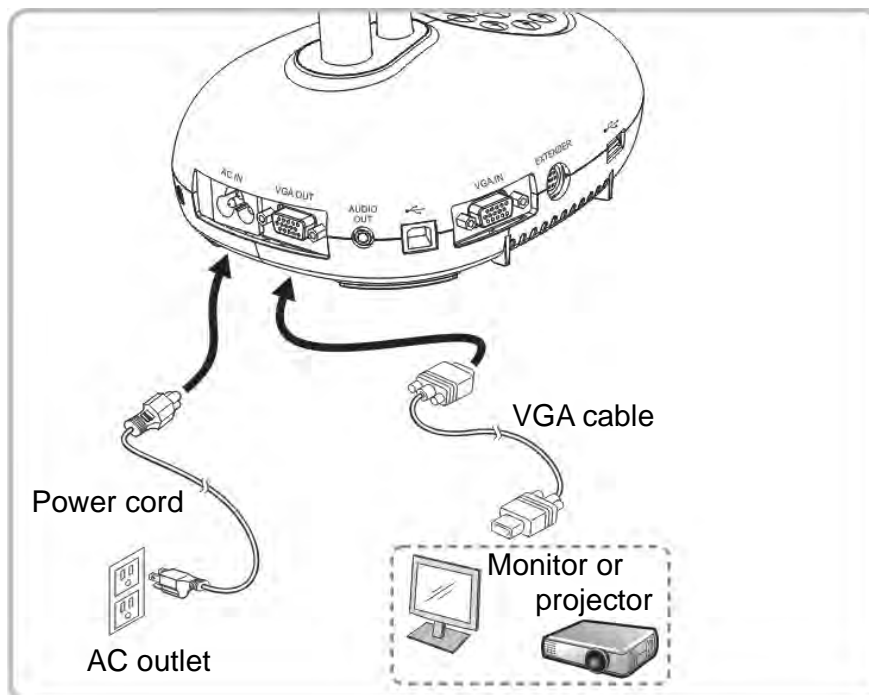

## 4.4 Connecting to an HDTV

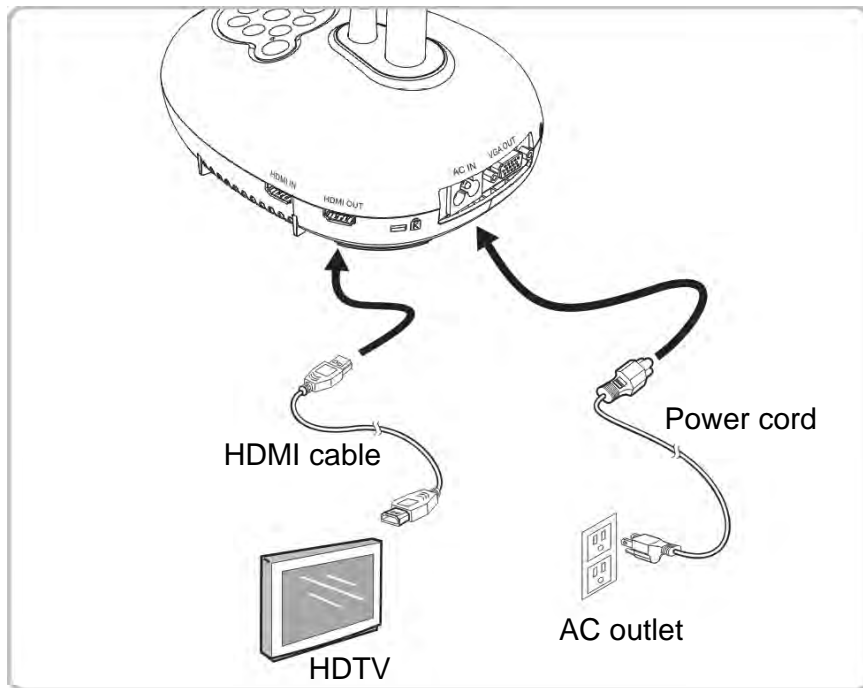

## 4.5 Connecting to a computer and use Lumens™ software

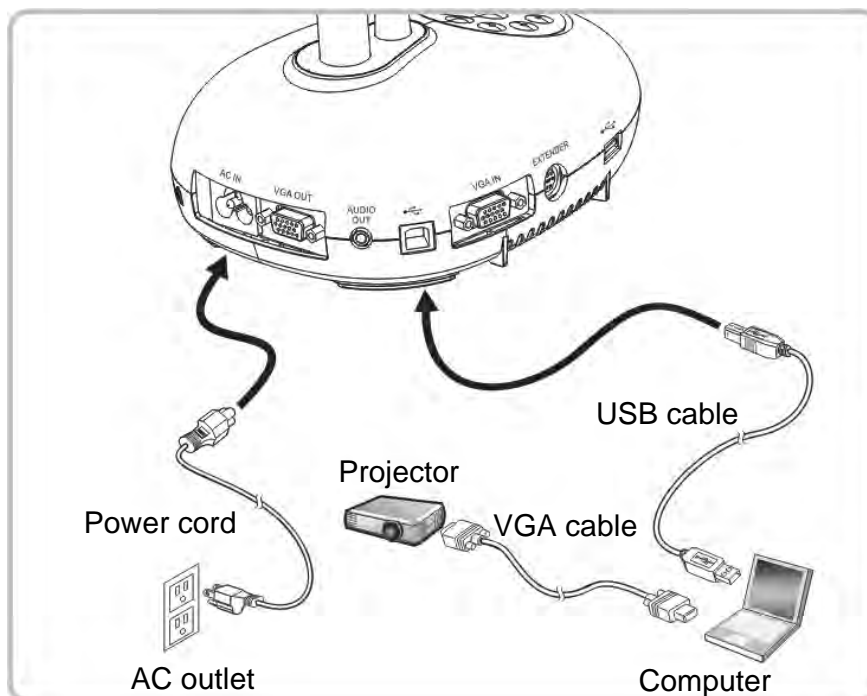

- The software can be downloaded from Lumens website

## 4.6 Connecting to a computer and projector or monitor simultaneously

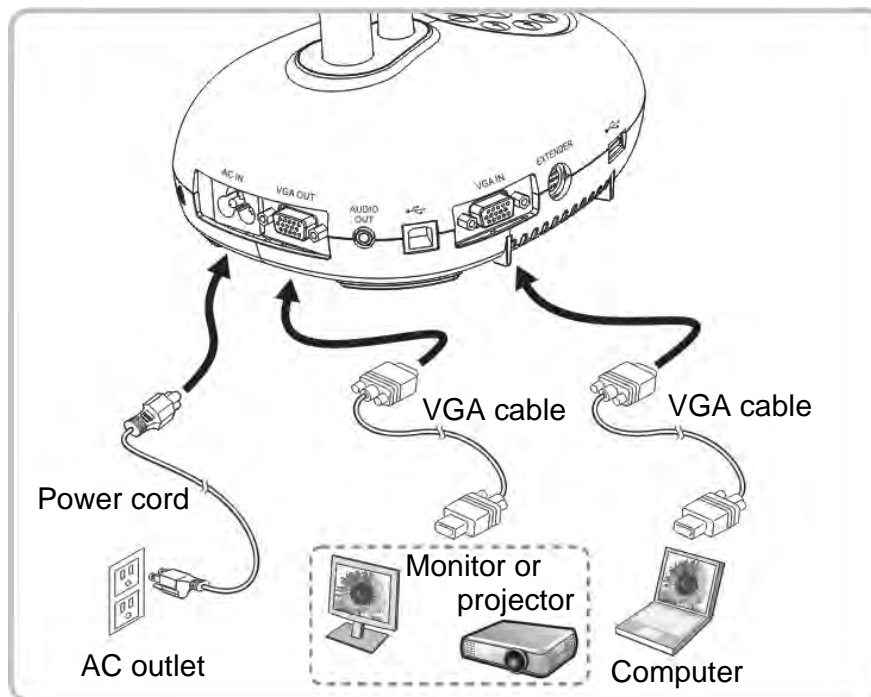

- Press [SOURCE] button to switch the image source.

## 4.7 Connecting to a computer and USB disk simultaneously

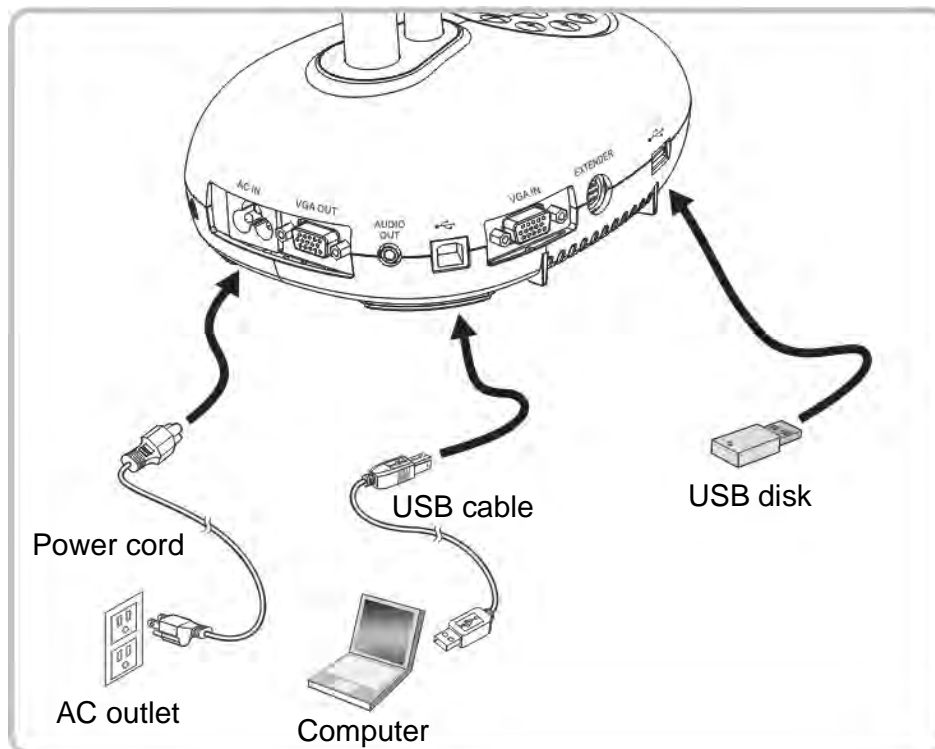

<Note> Connected to a computer and turned off, the Document Camera is just regarded as an external storage device.

## 4.8 Connecting to an Interactive Whiteboard (IWB)

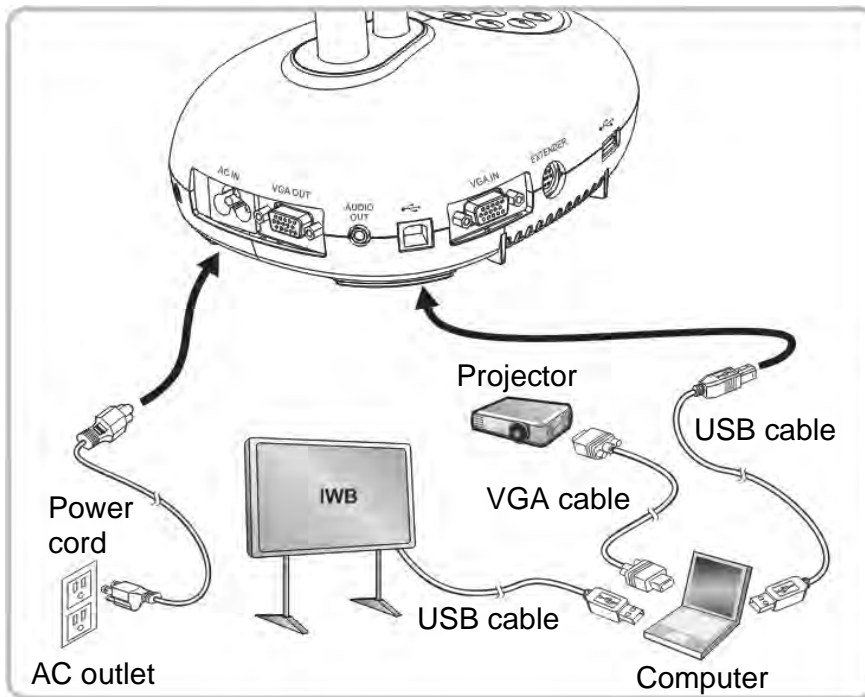

## 4.9 Connecting to a speaker

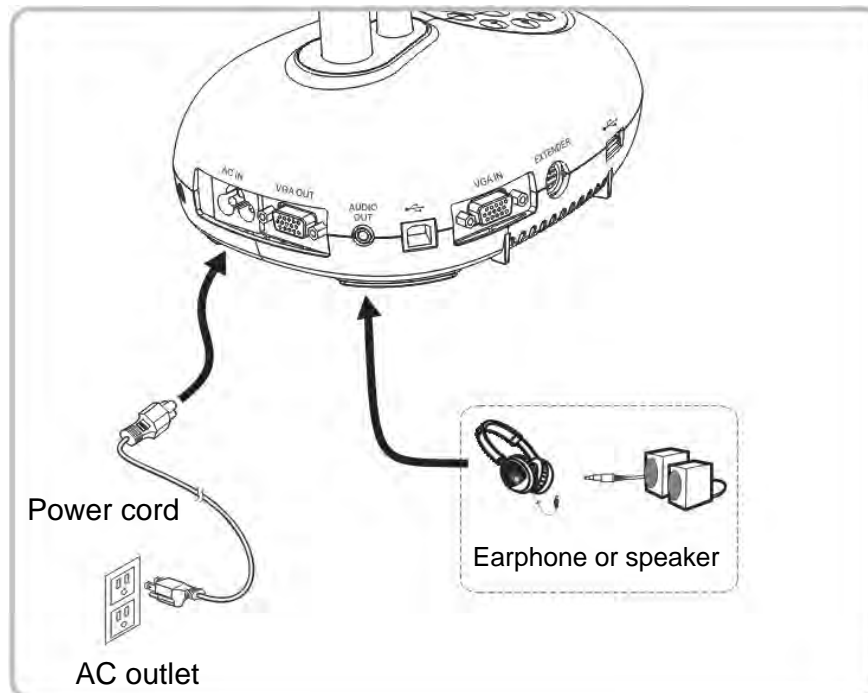



## 4.10 Connecting to a computer with RS232

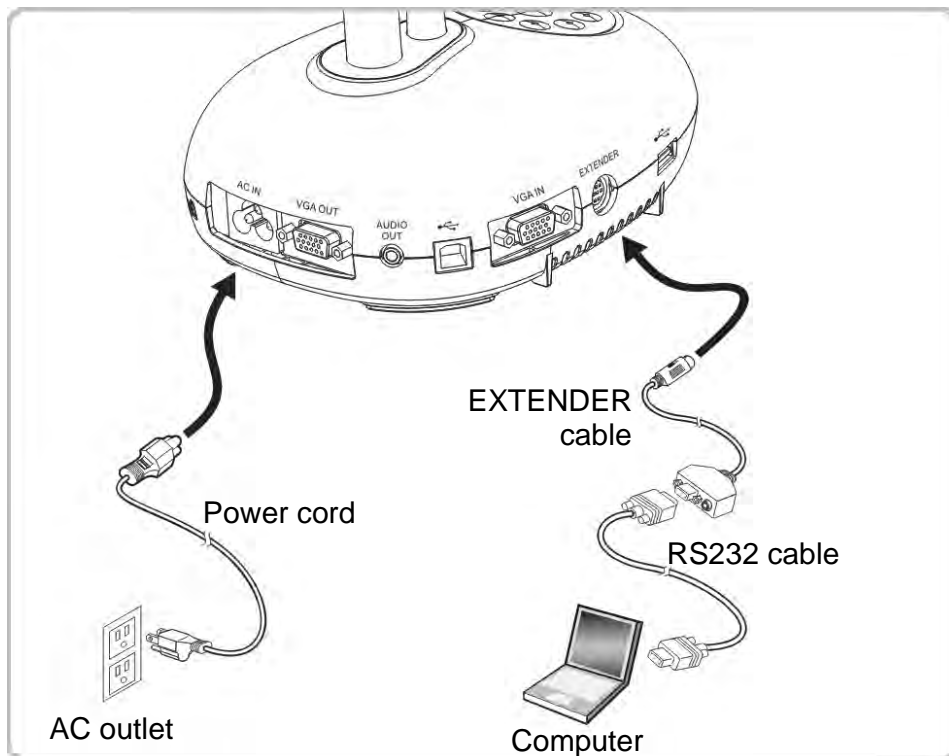

- After connecting to the RS232 cable, you can use RS232 commands to control DC193.

## 4.11 Connecting to a TV

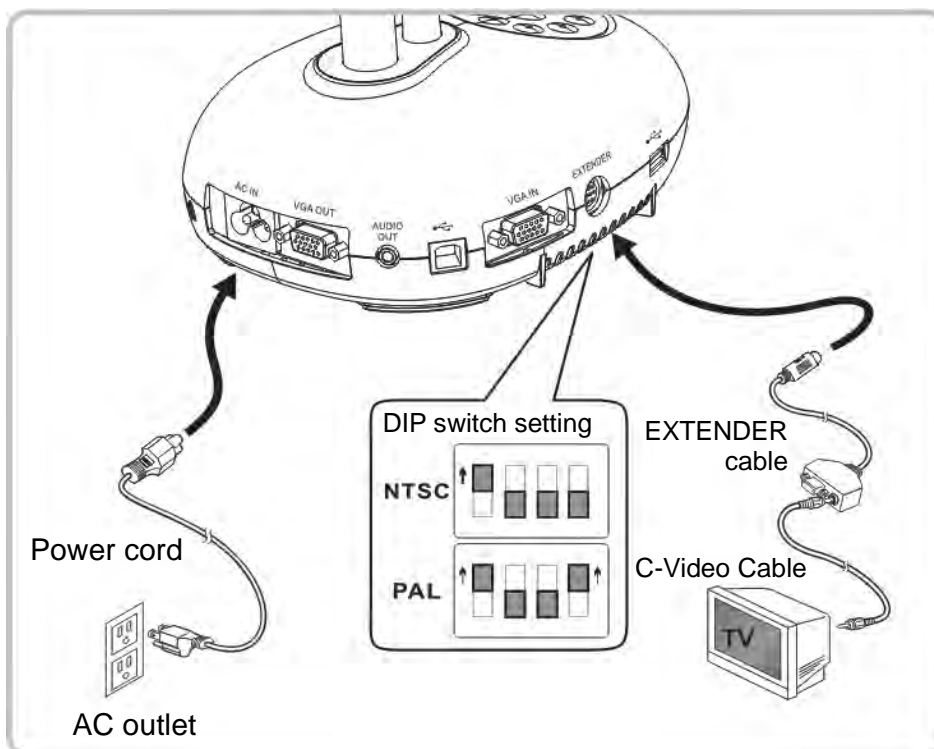

- NTSC: USA, Canada, Mexico, Panama, Chile, Japan, Taiwan, Korea, and Philippines.



➤ PAL: Countries/regions not listed above

**<Note> You should unplug and reconnect the power cord, and then restart the machine for DIP switch setting to take effect. Once C-VIDEO is enabled, VGA OUT is not supported.**

**<Note> Only the live image can be displayed in C-Video output mode.**

## 4.12 Full connectivity including USB

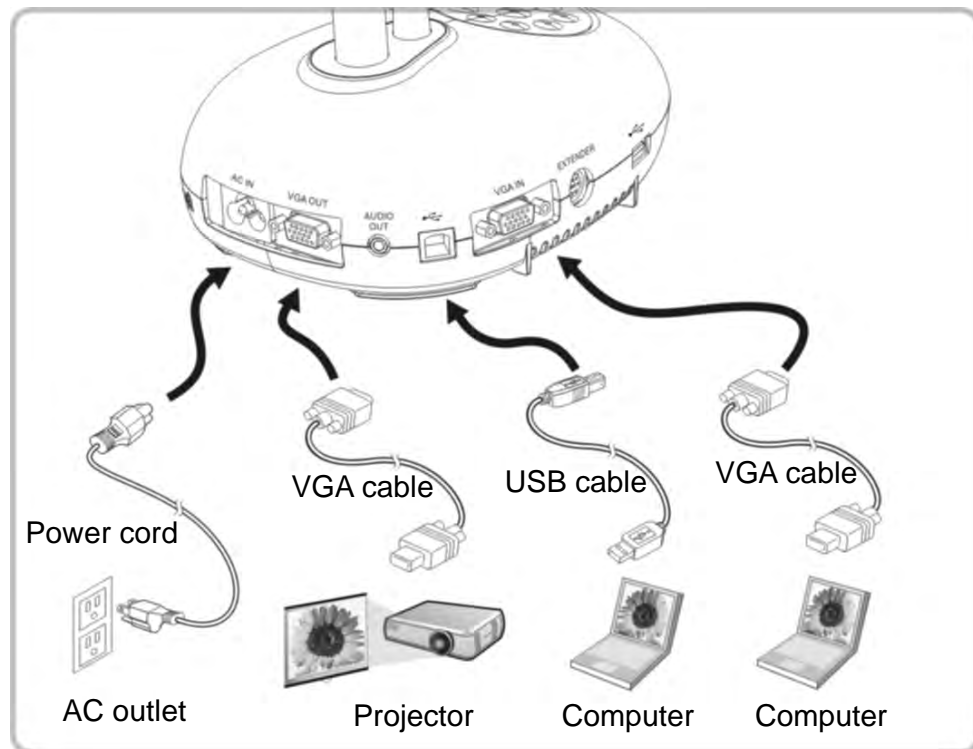

## 4.13 Installing application software

The application software installed on the computer enables you to:



- Control the DC193.
- Capture and record images.
- Annotate the image, highlight important details and save it.
- Support the full screen function.

**<Note> Please refer to [Ladibug™ software user manual](#) for installation steps and software operation.**

# Chapter 5 Start Using

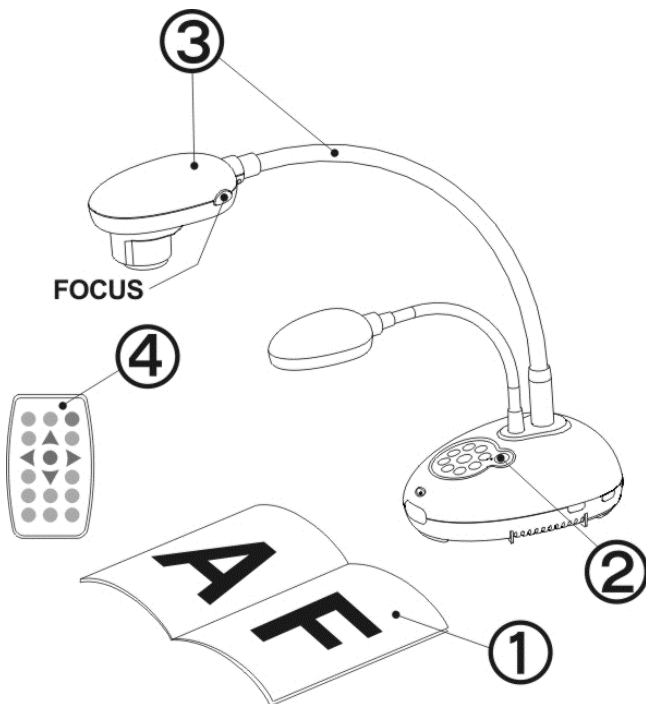
---











1. Place an object to be displayed under the camera.
2. Turn on Power .
3. Adjust the gooseneck and lens to the appropriate positions.
4. Press [AUTO TUNE]  button to optimize the image. You are ready to teach/present.
  - Each time the camera head is moved, please locate it and then press [FOCUS] to refocus the lens.











- When using the remote control, aim at the remote sensor on the DC193, and press the power button.
- Once DC193 is turned on, the LED on the control panel will flash a few times and stay lit. Please contact your distributor if the LED does not light up.

# Chapter 6 Control Panel/Remote Control and Setting Menu

## 6.1 Functions of control panel and remote control

<Remark> The below functions are listed alphabetically

Name	Function Descriptions	Operation
	Turn on and off the Document Camera. *Press and hold for 5 ~ 10 seconds to turn off	Remote control/ Control panel
	Move up, down, left or right to select the needed function.	Remote control/ Control panel
<b>FOCUS</b>	Auto focus.	Either sides of the lens
<b>AUTO TUNE</b> 	Automatically adjust the image to have the best brightness and focusing performance.	Remote control/ Control panel
<b>BRT+/-</b> 	Adjust the brightness of the image.	Remote control
<b>CAPTURE</b> 	Capture images to USB disk (priority) or internal memory.	Control panel
<b>CAPTURE /DEL</b> 	Capture and save images to USB disk (priority) or internal memory while displaying live images. Delete files from the USB disk (priority) or internal memory while reading the stored files (in Playback mode).	Remote control
<b>ENTER</b> 	Activate/Enter functions.	Remote control
<b>ENTER / FREEZE</b> 	Live image: Freeze the image OSD mode: Activate/Enter functions	Control panel















<b>FREEZE</b> 	Freeze the current image to remain temporarily on the screen. Press again to defreeze.	<b>Remote control</b>
<b>LAMP</b> 	Lamp mode toggle switch.	<b>Remote control/ Control panel</b>
<b>MASK</b> 	Activate Mask/Spotlight mode.	<b>Remote control</b>
<b>MENU</b> 	Activate the setting menu/exit the menu.	<b>Remote control/ Control panel</b>
<b>PAN</b> 	Enable/Disable the partial enlarged mode.	<b>Remote control</b>
<b>PIP</b> 	Image comparison (to compare live images with stored image files).	<b>Remote control</b>
<b>PLAYBACK</b> 	Read files stored in the USB disk (priority) or internal memory.	<b>Remote control/ Control panel</b>
<b>RECORD</b> 	Record motion images. Press [Record] to record images to USB disk and press [Record] again to stop recording.	<b>Remote control</b>
<b>ROTATE</b> 	Screen rotation 0°/180°/Flip/Mirror	<b>Remote control</b>
<b>SOURCE</b> 	Switch between different sources of signals: 1. Live images (default). 2. VGA and HDMI input (corresponding output).	<b>Remote control/ Control panel</b>
<b>ZOOM +/-</b> 	Increase or decrease the image size.	<b>Remote control/ Control panel</b>

## 6.2 Setting menu

### 6.2.1 Main menu

<Remark> Press [MENU] on the **remote control** or **control panel** to display the setting menu.



	<b>Auto Tune</b> Automatically adjust the image to have the best brightness and focusing performance.		<b>Slide Show</b> Show the photos or videos stored in the USB disk (priority) or internal memory in slide mode.
	<b>PAN</b> Enable/Disable the partial enlarged mode.		<b>Manual Focus</b> Manual Focus.
	<b>LAMP</b> Lamp mode toggle switch.		<b>Rotate</b> Screen rotation 0°/180°/Flip/Mirror
	<b>PIP</b> Image comparison (to compare live images with stored image files).		<b>Settings</b> Set up various functions.
	<b>Brightness</b> Adjust the brightness of the image.		<b>Photo/Text</b> Select Photo/Text/Gray Mode.
	<b>Mask</b> Activate the mask mode.		<b>Zoom</b> Increase or decrease the image size.
	<b>Mode</b> Select image mode.		<b>Spotlight</b> Activate the spotlight mode.

## 6.2.2 Setting menu

1 <sup>st</sup> Level Major Items	2 <sup>nd</sup> Level Minor Items	3 <sup>rd</sup> Level Adjustment Values	Function Descriptions
Capture Settings	Capture Mode	<u>Single Capture</u> / Time Lapse/ Record/Disable	Use the left and right arrow keys to select capture mode.
	Capture Time	1. <u>1 hr</u> 2. 2 hr 3. 4 hr 4. 8 hr 5. 24 hr 6. 48 hr 7. 72 hr	Use the left and right arrow keys to select the capture time. <b>&lt;Note&gt; This will be active only when capture mode is set to time lapse</b>
	Capture Interval	1. 3 sec 2. <u>5 sec</u> 3. 10 sec 4. 30 sec 5. 1 min 6. 2 min 7. 5 min	Use the left and right arrow keys to select the capture interval. <b>&lt;Note&gt; This will be active only when capture mode is set to time lapse</b>
	Image Quality	1. High 2. <u>Medium</u> 3. Low	Use the left and right arrow keys to select the image quality for the captured images and recorded videos
Storage	Slide Show	<u>ENTER</u>	Show the photos or videos stored in the USB disk (priority) or internal memory in slide mode.
	Delay	1. 0.5 sec 2. <u>1 sec</u> 3. 3 sec 4. 5 sec 5. 10 sec 6. Manual	Use the left and right arrow keys to select the delay time. Select manual mode to switch images manually.
	Copy To USB Disk	<u>ENTER</u>	Use the left and right arrow keys to select, and then press [ENTER] to confirm to copy files from internal memory to USB disk.
	Delete All	Yes/ <u>No</u>	Use the left and right arrow keys to select, press [ENTER] to confirm the deletion of all images from the USB disk (priority) or internal memory.
	Format	Yes/ <u>No</u>	Use the left and right arrow keys to select, and then press [ENTER] to format the USB disk (priority) or internal memory.

<b>Control</b>	<b>Auto Exposure</b>	<b><u>On</u></b> /Off	Regardless of outside environment, the machine will adjust the brightness to the optimal condition. Use the left and right arrow keys to select.
	<b>Auto White Balance</b>	<b><u>ENTER</u></b>	Regardless of outside light or color, the machine will adjust the color to the optimal condition; Press [ENTER] to execute.
	<b>Audio Out Volume</b>	0~ <b><u>A</u></b> ~Max	Use the left and right arrow keys to adjust the volume.
	<b>Microphone Levels</b>	0~ <b><u>A</u></b> ~Max	Use the left and right arrow keys to adjust the volume.
	<b>Projector Type</b>	DLP/ <b><u>LCD</u></b>	Use the left and right arrow keys to select the projector type and reduce image noise.
	<b>Digital Zoom</b>	On/ <b><u>Off</u></b>	Use the left and right arrow keys to turn on/off <b>digital zoom</b> .
<b>Advanced</b>	<b>Language</b>	<ol style="list-style-type: none"> <li>1. <b><u>English</u></b></li> <li>2. 繁體中文</li> <li>3. 简体中文</li> <li>4. Deutsch</li> <li>5. Français</li> <li>6. Español</li> <li>7. Русский</li> <li>8. Nederlands</li> <li>9. Suomi</li> <li>10. Polski</li> <li>11. Italiano</li> <li>12. Português</li> <li>13. Svenska</li> <li>14. dansk</li> <li>15. ČESKY</li> <li>16. العربية</li> <li>17. 日本語</li> <li>18. 한국의</li> <li>19. ελληνικά</li> <li>20. Latvijas</li> </ol>	<b><u>English</u></b> Traditional Chinese Simplified Chinese German French Spanish Russian Dutch Finnish Polish Italian Portuguese Swedish Danish Czech Arabic Japanese Korean Greek Latvian Use the left and right arrow keys in the Language option to select the preferred language.



	<b>Lock Down</b>	On/ <u>Off</u>	Use the left and right arrow keys to turn on/off the lock down function. You can set the password when [On] is selected.
	<b>Auto Erase</b>	On/ <u>Off</u>	Use the left and right arrow keys to turn on/off the auto erase function. When [On] is selected, the stored images will automatically be deleted when the system is turned off.
	<b>Preset Load</b>	Yes/ <u>No</u>	Read the value of the current image mode. Use the left and right arrow keys to select, and then confirm by pressing [ENTER].
	<b>Preset Save</b>	Yes/ <u>No</u>	Store the value of the current image mode. Use the left and right arrow keys to select, and then confirm by pressing [ENTER].
	<b>Splash Screen Settings</b>	<u>ENTER</u>	Open Splash Screen Setting window
	<b>Factory Reset</b>	Yes/ <u>No</u>	Use the left and right arrow keys to select, and then confirm by pressing [ENTER] to restore the factory defaults.
	<b>Firmware Version</b>	NA	Display FW version

### 6.2.3 Mask mode setting menu

2 <sup>nd</sup> Level Major Items	3 <sup>rd</sup> Level Minor Items	4 <sup>th</sup> Level Adjustment Values	Function Descriptions
<b>MASK Mode</b>	<b>Live</b>	<u>ENTER</u>	Press [ENTER] to return to live image.
	<b>Transparency</b>	0~ <u>2</u> ~3	Use the left and right arrow keys to adjust the transparency of the mask.
	<b>Step</b>	Large/ <u>Medium</u> /Small	Use the left and right arrow keys to select the step of the mask.
	<b>V Size</b>	0~ <u>A</u> ~Max	Use the left and right arrow keys to select the vertical height of the mask.
	<b>H Size</b>	0~ <u>A</u> ~Max	Use the left and right arrow keys to select the horizontal length of the mask.



	<b>Exit</b>	<b><u>ENTER</u></b>	Press [ENTER] to confirm your selection and exit the mask mode setting menu.
--	-------------	---------------------	--

## 6.2.4 Spotlight mode setting menu

2 <sup>nd</sup> Level Major Items	3 <sup>rd</sup> Level Minor Items	4 <sup>th</sup> Level Adjustment Values	Function Descriptions
<b>Spotlight Mode</b>	<b>Live</b>	<b><u>ENTER</u></b>	Press [ENTER] to return to live image.
	<b>Shape</b>	<b><u>Ellipse</u>/Rectangle</b>	Use the left and right arrow keys to select the shape of the spotlight zone.
	<b>Transparency</b>	0~ <b><u>2</u></b> ~3	Use the left and right arrow keys to adjust the transparency of the border in the spotlight mode.
	<b>Step</b>	Large/ <b><u>Medium</u></b> / Small	Use the left and right arrow keys to select the step of the spotlight zone.
	<b>V Size</b>	0~ <b><u>A</u></b> ~Max	Use the left and right arrow keys to adjust the height of the spotlight zone.
	<b>H Size</b>	0~ <b><u>A</u></b> ~Max	Use the left and right arrow keys to adjust the width of the spotlight zone.
	<b>Exit</b>	<b><u>ENTER</u></b>	Press [ENTER] to confirm your selection and exit the spotlight mode setting menu.







## 6.2.5 Splash Setting Windows

2 <sup>nd</sup> Level Major Items	3 <sup>rd</sup> Level Minor Items	4 <sup>th</sup> Level Adjustment Values	Function Descriptions
<b>Splash Screen Setting</b>	<b>Power On Image Setting</b>	<b><u>Default</u>/Customer</b>	Select to use Default/Customer power on image
	<b>Power On Logo Show Time</b>	4~30 sec	Set up power on logo show time
	<b>Power On Image Select</b>	<b><u>ENTER</u></b>	Select power on image. Only pictures in JPEG format are supported
	<b>Exit</b>	<b><u>ENTER</u></b>	Press [ENTER] to confirm your selection and exit splash screen setting window.

## 6.2.6 Annotation

After the mouse is connected, right click or left click and hold the mouse to start the tools.

<Note> When the setting menu is activated, the tools cannot be used.

Icon	Description
	Custom tool 1
	Custom tool 2
	Eraser
	Clear all
	Open setting menu of the annotation tool
	Exit the annotation tool

## 6.2.7 Setting menu of the annotation tool

2 <sup>nd</sup> Level Major Items	3 <sup>rd</sup> Level Minor Items	4 <sup>th</sup> Level Adjustment Values	Function Descriptions
	Tools Select	<u>Pen</u> /Line/Ellipse/Rectangle	Select an annotation tool
	Color Select	<u>Red</u> /blue/black/green/pink/white/cyan/yellow	Select the pen color
	Line Width	1~ <u>3</u> ~10	Select the line width
	Tools Select	<u>Pen</u> /Line/Ellipse/Rectangle	Select an annotation tool
	Color Select	Red/ <u>blue</u> /black/green/pink/white/cyan/yellow	Select the pen color
	Line Width	1~ <u>3</u> ~10	Select the line width
	Line Width	1~ <u>3</u> ~10	Select the line width

# Chapter 7 Descriptions of Major Functions

---

## 7.1 I would like to automatically adjust the image to have the best brightness and focusing performance

Use the remote control or control panel:

1. Press [AUTO TUNE] for the best brightness and focusing performance.

## 7.2 I would like to switch image sources

**Live image** is the default image source. Press [SOURCE]  on the **remote control or control panel** to have DC193 switch among the following images sources:

1. Live images (default).
2. VGA IN / HDMI IN.

**<Remark> This image switch applies to VGA OUT/HDMI OUT simultaneously.**

## 7.3 I would like to switch the image mode

Use the remote control or control panel:

- 1 Press [MENU] to activate the setting menu.
- 2 Press [▲], [▼], [▶], or [◀] to select [Image mode].
- 3 Press [▶] or [◀] to the [Normal/Film/Slide/Microscope].

## 7.4 I would like to make text clearer and photos more colorful

### 7.4.1 Photo/Text mode descriptions

The default [Photo/Text] mode is in Photo (**Photo mode**). To change this setting, please use the **remote control** or the **control panel** to activate the options of the setting menu.

- [Photo] (default): for viewing photos or text with photos, making photos more colorful.
- [Text]: for viewing text files, making the text clearer.
- [Gray]: for viewing black & white photos which will make the grayscale differentiation distinct.

### 7.4.2 Set up Photo/Text mode

To change the settings, please use the **remote control** or the **control panel**:

1. Press [MENU] to activate the setting menu.
2. Press [▲], [▼], [▶] or [◀] to select [Photo/Text]. (Please refer to [7.4.1 Photo/Text mode descriptions](#) to make the best choice.)
3. Press [ENTER] to activate.
4. Press [▶] or [◀] to select the [Photo/Text/Gray].

## 7.5 I would like to zoom in/out images

1. Press [ZOOM+] on the **remote control** or **control panel** to zoom in images.
2. Press [ZOOM-] on the **remote control** or **control panel** to zoom out images.

**<Remark> When the magnification is too high to enable focus, it will return to normal range automatically.**

## 7.6 I would like to use the auto focus

1. Press the [FOCUS] AF button on the right side of the lens.

## 7.7 I would like to adjust the brightness

### **Remote control:**

1. Press [BRT +] to make it brighter.
2. Press [BRT -] to make it darker.

### **Control panel:**

1. Press [MENU] to activate the setting menu.
2. Press [▲], [▼], [▶] or [◀] to select [Brightness].
3. Press [ENTER] to activate.
4. Press [▶] or [◀] to adjust the brightness.

## 7.8 I would like to turn on/off the lamp

The default of the lamp is **OFF**. When using the **remote control** or **control panel**:

1. Press [LAMP] to switch On/Off. (The sequence of switching is: Off/Arm Lamp/Both Lamps/Head Lamp)

## 7.9 I would like to freeze images

1. Press [FREEZE] on the **remote control** or **control panel** to freeze the current image on the screen. Press again to defreeze.

## 7.10 I would like to rotate the image

### Remote control:

1. Press [ROTATE] key to rotate the screen. (The sequence of switching is: 0°/180°/Flip/Mirror)

### Control panel:

1. Press [MENU] to activate the setting menu.
2. Press [▲], [▼], [▶], or [◀] to select [Rotate].
3. Press [ENTER] to activate.
4. Press [▶] or [◀] to switch the rotation method. (The sequence of switching is: 0°/180°/Flip/Mirror)
5. Press [MENU] to exit.

## 7.11 I would like to capture images

### 7.11.1 Capture and save images

1. Press [CAPTURE] on the **remote control** or **control panel** to capture and save images.
  - **You cannot capture images when the capture mode is set to [Disable]. If it is set to [Continuous], you can capture images continuously. Press [Capture] to start capturing continuously, or press [Capture] again to exit.**
  - **To change the quality of captured images, please refer to [7.11.2 Setting the quality of captured images](#).**
  - **To change the setting of captured images, please refer to [7.11.3 Setting continuous capture](#).**

### 7.11.2 Setting the quality of captured images

1. Press [MENU] on the **remote control** or **control panel** to activate the setting menu.
2. Press [▲], [▼], [▶], or [◀] to select [Setting].
3. Press [ENTER] to activate.
4. Press [▶] or [◀] to the [Capture] menu.
5. Press [▼] to find [Image Quality].
6. Press [▶] or [◀] to select among [High/Medium/Low].
7. Press [MENU] to exit.

### 7.11.3 Setting continuous capture

1. Press [MENU] on the **remote control** or **control panel** to activate the setting menu.
2. Press [▲], [▼], [▶], or [◀] to select [Setting].
3. Press [ENTER] to activate.
4. Press [▶] or [◀] to the [Capture] menu.
5. Press [▼] to the [Capture Mode].
6. Press [▶] or [◀] to select [Time Lapse].
7. Press [▼] to find [Capture Time]; Press [▶] or [◀] to set capture time.
8. Press [▼] to find [Capture Interval]; Press [▶] or [◀] to set interval time.
9. Press [MENU] to exit.

## 7.12 I would like to record images

<Note> Connect USB disk to DC193 to start recording images.

### 7.12.1 Recording motion images

<Remark> You may not be able to capture or record images when [Capture Image] mode is set to [Disable].

**Remote control:**

1. Press [RECORD] on the **remote control** to start recording images.
2. Record sounds with the built-in microphone of the control panel.
3. Press [RECORD] again to stop recording.

**Control panel:**

1. Press and hold [Capture] button for about 2 seconds to start recording images
2. Press [Capture] again to stop recording.

### 7.12.2 Setting the quality of captured images

1. Press [MENU] on the **remote control** or **control panel** to activate the setting menu.
2. Press [▲], [▼], [▶], or [◀] to select [Setting].
3. Press [ENTER] to activate.
4. Press [▶] or [◀] to the [Capture] menu.
5. Press [▼] to find [Image Quality].

6. Press [▶] or [◀] to select among [High/Medium/Low].
7. Press [MENU] to exit.

### 7.12.3 Recording setup

1. Press [MENU] on the **remote control** or **control panel** to activate the setting menu.
2. Press [▲], [▼], [▶], or [◀] to select [Setting].
3. Press [ENTER] to activate.
4. Press [▶] or [◀] to the [Capture] menu.
5. Press [▼] to the [Capture Mode].
6. Press [▶] or [◀] to select [Record].
7. Press [MENU] to exit.

**<Remark> When the [Capture Image] mode is set to [Record], the function of [Capture] on the control panel is changed to image recording.**

### 7.12.4 Adjust the volume of microphone

1. Press [MENU] on the **remote control** or **control panel** to activate the setting menu.
2. Press [▲], [▼], [▶], or [◀] to select [Setting].
3. Press [ENTER] to activate.
4. Press [▶] or [◀] to the [Control] menu.
5. Press [▼] to the [MIC Vol.].
6. Press [▶] or [◀] to adjust the volume.
7. Press [MENU] to exit.

### 7.12.5 Playing images

- To play images, please refer to [7.13 I would like to view captured/recorded images.](#)

## 7.13 I would like to view captured/recorded images

1. Press [PLAYBACK] on the **remote control** or **control panel** to display thumbnails of all stored files.
2. Press [▶], [◀], [▲], or [▼] to select the thumbnail you want to play.
3. Press [ENTER] for full-screen play.
4. When the video is played, it can be paused/played by pressing [Freeze].

5. Press [▶] or [◀] to select the next or previous audio/video file.
6. Press [▲] or [▼] to adjust the volume of the video.
7. Press [MENU] to exit.

**<Note> An external speaker must be connected to AUDIO OUT to play sound when you use VGA OUT.**

## **7.14 I would like to delete the captured/recorded images**

### **Remote control:**

1. Press [PLAYBACK] to show the thumbnails of all stored files.
2. Press [▲], [▼], [◀], or [▶] to select the file you want to delete.
3. Press [DELETE] to display a [Delete File] window.
4. Press [▶] or [◀] to select [Yes].
5. Press [ENTER] to delete the selected file.
6. Select [No] and press [ENTER] to exit [Delete File] window.
7. Press [MENU] to exit.

## **7.15 I would like to automatically delete the stored images whenever it is turned off (Auto Erase)**

### **Use the remote control or control panel:**

1. Press [MENU] to activate the setting menu.
2. Press [▲], [▼], [▶], or [◀] to select [Setting].
3. Press [ENTER] to activate.
4. Press [▶] or [◀] to the [Advanced] menu.
5. Press [▲] or [▼] to [Auto Erase].
6. Press [▶] or [◀] to select [On].
7. Press [MENU] to exit.

## **7.16 I would like to enlarge a part of the image (PAN)**

### **Use remote control:**

1. Press [PAN] to activate the partial enlarged mode.
2. Press [▲], [▼], [◀], or [▶] to move and view the partial enlarged images.
3. Press [PAN] to exit the partial enlarged mode.

### **Use control panel:**

1. Press [MENU] to activate the setting menu.
2. Press [▲], [▼], [▶], or [◀] to select [PAN].



3. Press [ENTER] to execute.
4. Press [▲], [▼], [◀], or [▶] to move and view the partial enlarged images.
5. Press [MENU] to exit the partial enlarged mode.

## 7.17 I would like to use the MASK and Spotlight function

### 7.17.1 I would like to use the mask or spotlight mode

#### Use remote control:

1. Press [MASK] to activate the mask/spotlight mode menu.
2. Press [◀] or [▶] to select the mode and press [ENTER] to activate.
3. Press [▲], [▼], [◀], or [▶] to move the zone position.
4. Press [MASK] again to exit and return to the live image screen.

#### Use control panel:

1. Press [MENU] to activate the setting menu.
2. Press [▲], [▼], [▶], or [◀] to select [Mask], Press [ENTER] to activate mask mode or select [Spotlight] and press [ENTER] to activate spotlight mode.
3. Press [MENU] to activate the image OSD menu.
4. Press [▲] or [▼] to select [Live Image].
5. Press [ENTER] to return to live image.

### 7.17.2 I would like to set the size of mask

I would like to use the **remote control** under the mask mode:

1. Press [MENU] to activate the image OSD menu.
2. Press [▲] or [▼] to select the item to be modified [Transparency/Step/V Size/H Size]. **(For details, please refer to [6.2 Setting menu.](#))**
3. Press [◀] or [▶] to perform the modification.
4. Press [MENU] to exit the image OSD menu and return to the mask mode.

### 7.17.3 I would like to set spotlight function

Use the **Remote Control** under spotlight mode:

1. Press [MENU] to activate the image OSD menu.
2. Press [▲] or [▼] to select the item to be modified [Shape/Transparency/Step/V Size/H Size]. **(For details, please refer to [6.2 Setting menu.](#))**

3. Press [◀] or [▶] to perform the modification.
4. Press [MENU] to exit the image OSD menu and return to spotlight mode.

## 7.18I would like to play the slides (Slide Show)

### 7.18.1 Setting delay time

1. Press [MENU] on the **remote control** or **control panel** to activate the setting menu.
2. Press [▲], [▼], [▶], or [◀] to select [Setting].
3. Press [ENTER] to activate.
4. Press [▶] or [◀] to the [Storage] menu.
5. Press [▼] to find [Delay].
6. Press [▶] or [◀] to select the delay time between [0.5 sec/1 sec/3 sec/5 sec/10 sec/Manual].
7. Press [MENU] to exit.

### 7.18.2 Playing/Pausing/Stopping the slide show

<Note> Upper limit: The maximum size of single photo is 7 MB.

If you use the remote control or the control panel

1. Press [MENU] to activate the setting menu.
2. Press [▲], [▼], [▶], or [◀] to select [Slide Show].
3. Press [ENTER] to play.
4. Press [ENTER] again to pause/play.
5. Press [MENU] to exit.

## 7.19I would like to compare images (compare live images with stored image files (PIP))

This function will compare and contrast a live image with a stored image.

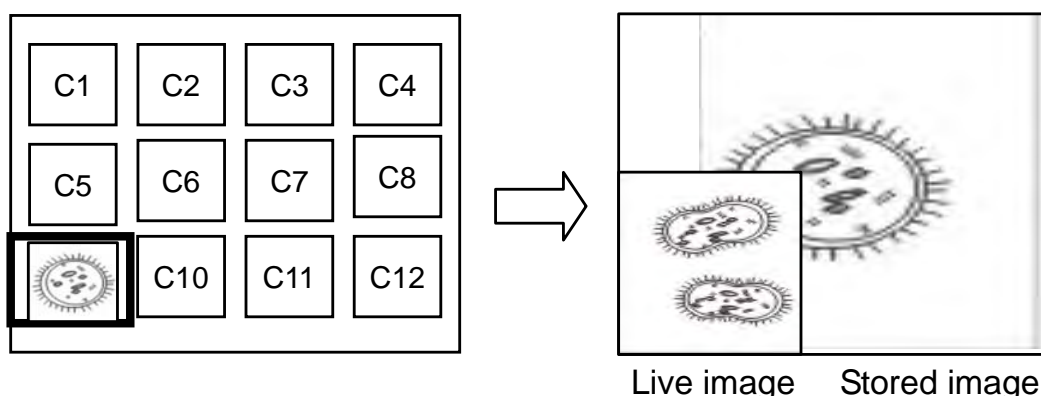

## Remote control:

1. Press [Playback] to activate the Playback image thumbnails.
2. Press [▲], [▼], [◀], or [▶] to select the file to be compared.
3. Press [PIP] to execute image comparison.
4. Press [▲], [▼], [◀], or [▶] to move the live image.
5. Repeat Steps 1 - 3 to change other image files.
6. Press [MENU] to exit.

## 7.20I would like to reduce the image noise (Projector Type)

1. This function enables Document Camera to automatically clear image noise. The noise is especially obvious when Document Camera is connected to a DLP projector. You can set the DLP projector to improve the image quality.
2. If there is special noise when VGA out is connected, please set DLP option to improve the image quality.

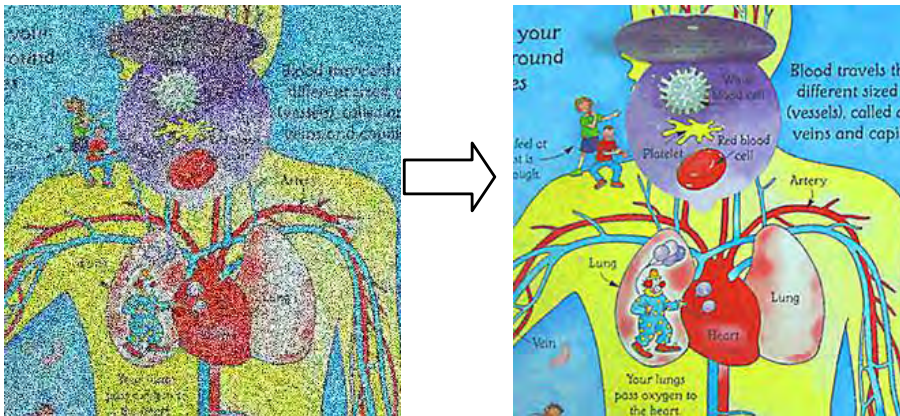

- 2.1. Press [MENU] on the **remote control** or **control panel** to activate the setting menu.
- 2.2. Press [▲], [▼], [▶], or [◀] to select [Setting].
- 2.3. Press [ENTER] to activate.
- 2.4. Press [▶] or [◀] to select [Control].
- 2.5. Press [▼] to [Projector Type].
- 2.6. Press [▶] or [◀] to select [**LCD/DLP**].
- 2.7. Press [MENU] to exit.

## 7.21 I would like to resume the factory default setting (Factory Reset)

1. Press [MENU] on the **remote control** or **control panel** to activate the setting menu.
2. Press [▲], [▼], [▶], or [◀] to select [Setting].
3. Press [ENTER] to activate.
4. Press [▶] or [◀] to select [Advanced] menu.
5. Press [▼] to select [Factory Reset].
6. Press [▶] or [◀] to select [Yes].
7. Press [ENTER] Execute ◦

## 7.22 I would like to change the power on image

<Note> The power on image file must be less than 5 MB and in JPEG format.

<Note> To save the file, please follow the instruction below:

File path: \DCIM\100MEDIA, for example: J: \DCIM\100MEDIA

File name: four English letters+ four numbers, for example: LUMN0001.JPG

1. Press [MENU] on the remote control or control panel to activate the setting menu.
2. Press [▲], [▼], [▶], or [◀] to select [Setting].
3. Press [ENTER] to activate.
4. Press [▶] or [◀] to select [Advanced] menu.
5. Press [▼] to select [Splash Screen Settings].
6. Press [ENTER] to activate.
7. Press [▲] or [▼] to select [Power On Image Setting] and press [▶] or [◀] to select [Default/Custom].
8. Press [▲] or [▼] to select [Power On Logo Show time] and press [▶] or [◀] to set up the time.
9. Skip to Step 11 if your select [Default] in Step 7
10. Press [▲] or [▼] to [Power On Image Select] and press [ENTER] to read selected file.
11. 按[▼] to [Exit] and press [ENTER] to exit.

## 7.23 Computer-related functions

Ensure that the USB cable is connected and the drivers are installed before using the computer-related functions. Refer to [Chapter 4](#)

### 7.23.1 I would like to insert a photo in MS-Paint

1. Click [File/From Scanner or Camera] in MS-Paint as shown in the bottom left figure.

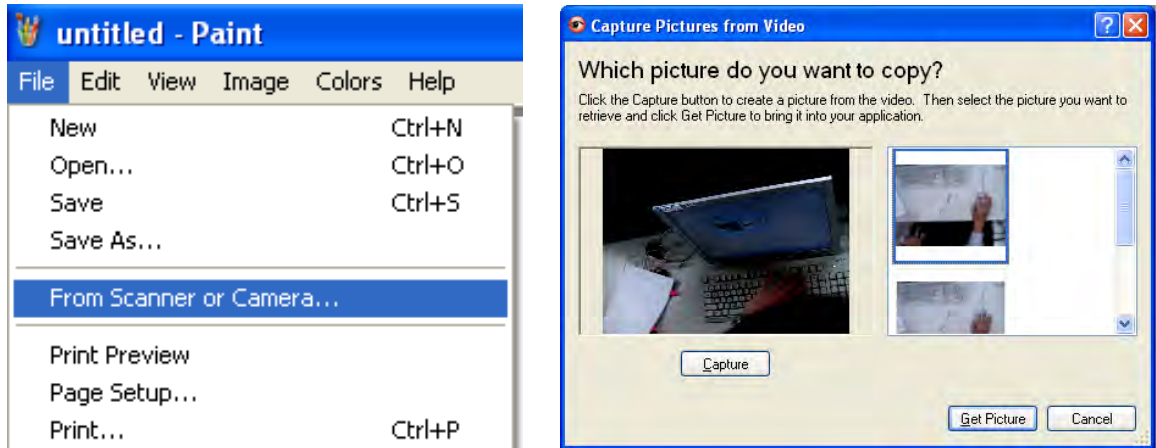

2. Complete by clicking [Get Picture] as shown in the top right figure.  
<Remark> Support Windows XP Operation System only.

### 7.23.2 I would like to insert photos in Photoshop

1. Click [File/Import/WIA-USB Video Device] in **Photoshop** as shown in the bottom left figure.

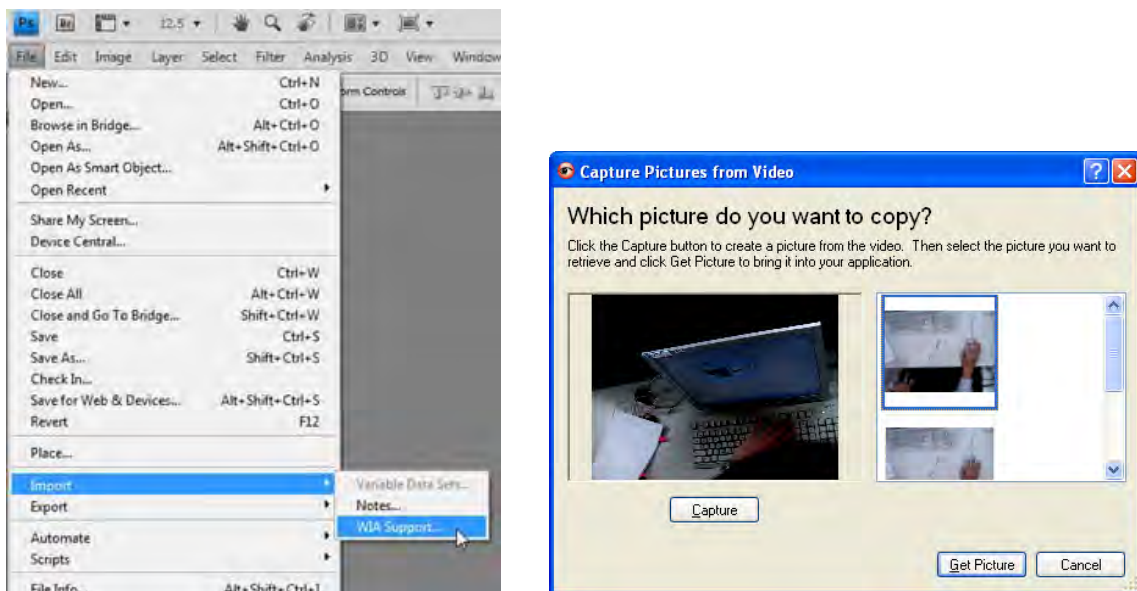

2. Complete by clicking [Capture] and then clicking [Get Picture] as shown in the top right figure.



# Chapter 8 Connecting to Microscope

- 1 Mount the microscope adapter accessories onto the microscope  
<Note> Please choose an appropriate microscope adapter. Microscope adapter accessories are applicable to eyepieces of Ø28 mm, Ø31 mm and Ø34 mm.
- 2 Connect the lens of DC193 with the microscope adapter

For eyepieces of Ø34 mm, only fit one microscope adapter (with the greatest diameter).

For eyepieces of Ø28 mm or Ø31 mm, fit one microscope adapter with the greatest diameter along with another appropriate one.

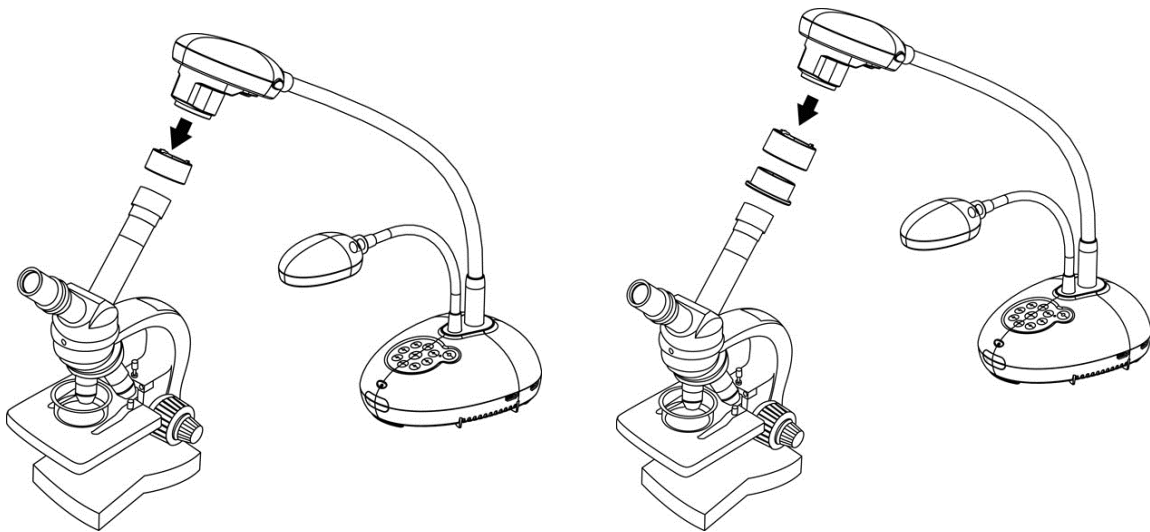

- 3 If the image is not clear
  - 3.1. Please adjust the focus of microscope.
  - 3.2. Please press the [FOCUS] button on either side of the DC193 lens to execute the auto focus.

# Chapter 9 DIP switch setting

---

<Note> You should unplug and reconnect the power cord, and then restart the DC193 for all DIP switch settings to take effect.

## 9.1 Connecting to a projector or monitor

### 9.1.1 XGA output (default values):

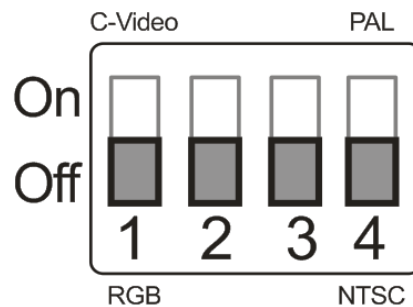

### 9.1.2 SXGA output

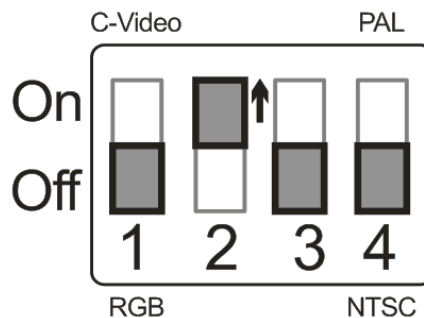

### 9.1.3 WXGA output

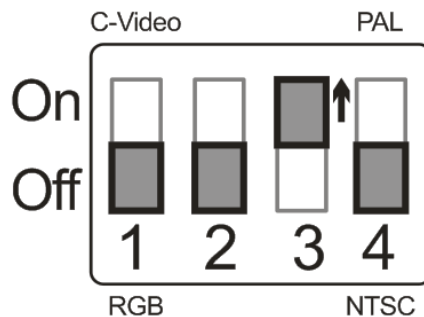

### 9.1.4 1080P output

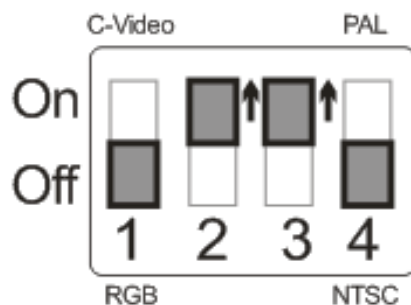

## 9.2 Connecting to a TV

### 9.2.1 NTSC: USA, Taiwan, Panama, Philippines, Canada, Chile, Japan, Korea, and Mexico

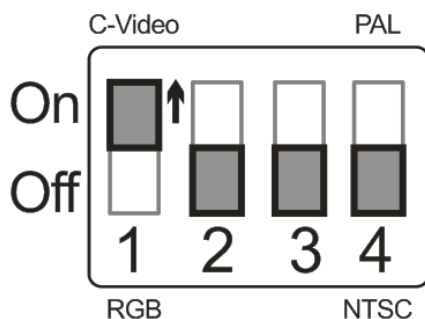

### 9.2.2 PAL: Countries/regions not listed above

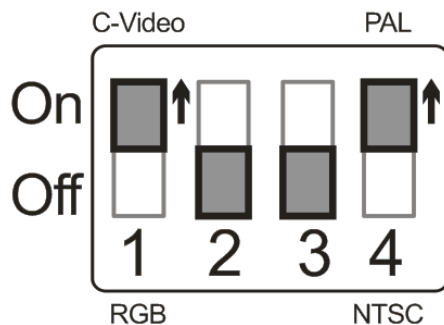

<Remark> Once C-VIDEO is enabled, VGA OUT is not supported.



# Chapter 10 Troubleshooting

This chapter describes problems you may encounter while using DC193. If you have questions, please refer to related chapters and follow all the suggested solutions. If the problem still occurred, please contact our distributors or service center.

No.	Problems	Solutions
1	<b>Boot without power signal</b>	Make sure you have plugged in the power cord.
2	<b>There is no image output from DC193</b>	<ol style="list-style-type: none"> <li>1. Check the power.</li> <li>2. Check all cable connections. Refer to <a href="#">Chapter 4 Installation and Connections</a> in this manual.</li> <li>3. Check the [Source], refer to <a href="#">7.2 I would like to switch image sources of Chapter 7 Descriptions of Major Functions</a>.</li> <li>4. Check the settings for the source of the projector. Please refer to the user manual of the projector.</li> <li>5. Check if DIP switch is properly set. Please refer to <a href="#">Chapter 9 DIP Switch Setting</a> for related settings.</li> </ol>
3	<b>Unable to focus</b>	Probably the document is too close. Press [ZOOM -] on the <b>remote control</b> or <b>control panel</b> . Or pull away the lens from the document to increase the distance, and then press the [FOCUS] button on the right side of the lens for auto focus.
4	<b>The image is incomplete</b>	Check the Auto Image setting of your projector. Please refer to the user manual of the projector or check for the DIP switch setting.
5	<b>Lumens Document Camera, Ladibug™ and other applications cannot be used simultaneously</b>	<b>Lumens Document Camera, Ladibug™</b> and other applications cannot be used simultaneously. Only one application can be executed at a time. Please close the currently running applications and then execute the application to be used.
6	<b>When DC193 is turned on, the auxiliary floodlight do not light</b>	Please make sure the arm lamp is set to [Off]. For the switch-on or -off of arm lamp, please refer to <a href="#">7.8 I would like to turn on/off the lamp of Chapter 7 Descriptions of Major Functions</a> .
7	<b>DC193 fails to store images or react</b>	<ol style="list-style-type: none"> <li>1. Check to see if the stored data have reached the maximum size of the USB disk (priority) or internal memory.</li> <li>2. Please make sure if the capture function is set to</li> </ol>

		continuous mode or the time for capture is set to be long. For the related setting, please refer to <a href="#">7.11 I would like to capture images of Chapter 7 Descriptions of Major Functions</a> .
8	<b>The images output from DC193 are too bright, dark or vague</b>	Press [AUTO TUNE] button to automatically adjust the image to have the best brightness and focusing performance.
9	<b>Unable to record images</b>	<ol style="list-style-type: none"> <li>1. Check to see if the stored data have reached the maximum size of the USB disk.</li> <li>2. The recording function is not supported in the internal memory. Please make sure that USB disk is inserted for image recording.</li> </ol>
10	<b>The operating steps in the manual are not applicable to the machine</b>	<p>The operating steps in the manual may be not applicable to the machine due to improvement in functions. Check to see if the Firmware version of your machine is up-to-date.</p> <ol style="list-style-type: none"> <li>1 Please go to Lumens official website to check whether the latest version is available for update. <a href="http://www.MyLumens.com/goto.htm">www.MyLumens.com/goto.htm</a></li> <li>2 The steps to check the FW version are as below: <ol style="list-style-type: none"> <li>2.1 Press [MENU] on the remote control or control panel to activate the setting menu.</li> <li>2.2 Press [▲], [▼], [▶], or [◀] to select [Setting].</li> <li>2.3 Press [ENTER] to activate.</li> <li>2.4 Press [▶] or [◀] to select [Advanced] menu.</li> <li>2.5 View [Firmware Version].</li> </ol> <p>If you are not sure whether it is the latest version, please consult your distributor for advice.</p> <a href="http://www.MyLumens.com/en/Request_form.php">http://www.MyLumens.com/en/Request_form.php</a> </li> </ol>
11	<b>How to unlock the locked device</b>	<ol style="list-style-type: none"> <li>1. Press [MENU] on the <b>remote control</b> or <b>control panel</b> to activate the setting menu.</li> <li>2. Press [▲], [▼], [▶], or [◀] to select [Setting].</li> <li>3. Press [ENTER] to activate.</li> <li>4. Press [▶] or [◀] to select [Advanced] menu.</li> <li>5. Press [▼] to [Lock Down].</li> <li>6. Press [▶] or [◀] to select [Off] and cancel the password setting function.</li> </ol>
12	<b>The data in the USB flash drive cannot be read.</b>	<ol style="list-style-type: none"> <li>1. The USB flash drive with the capacity of 4 G and above is recommended (up to 64 G supported)</li> <li>2. Please make sure the file was saved at the specified path: \DCIM\100MEDIA. (E.g.: J: \DCIM\100MEDIA)</li> </ol>

		3. Please make sure the file is named appropriately, e.g. four English letters + four numbers. (E.g.: LUMN0001.JPG)
--	--	---