

# INSTALLATION

## Tools Needed

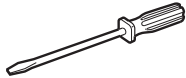

Pliers



Flat-blade  
Screwdriver

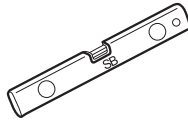

Level

## Installation Overview

Please read the following installation instructions first after purchasing this product or transporting it to another location.

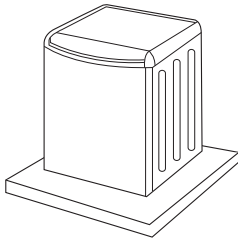

Choosing the proper location

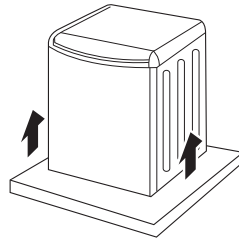

Unpacking and removing shipping material

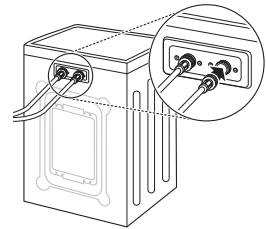

Connecting the water lines

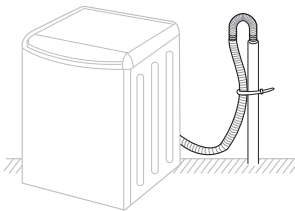

Connecting the drain hose

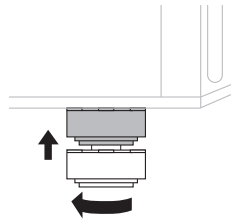

Leveling the washer

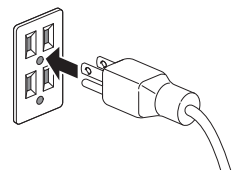

Connecting to the power supply

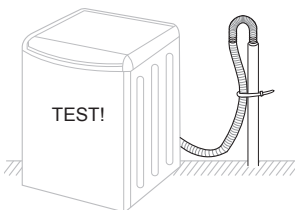

Testing the washer

## Product Specifications

The appearance and specifications listed in this manual may vary due to constant product improvements.

<b>Electrical requirements</b>	120 VAC @ 60 Hz
<b>Min. / Max. water pressure</b>	20 - 120 psi (138 - 827 kPa)
<b>Dimensions</b>	27" (W) X 28 <sup>3</sup> / <sub>8</sub> " (D) X 44 <sup>1</sup> / <sub>2</sub> " (H), 57 <sup>1</sup> / <sub>4</sub> " (H with lid (door) open) 68.6 cm (W) X 72.1 cm (D) X 113 cm (H), 145.3 cm (H with lid (door) open)
<b>Net weight</b>	134.5 lbs. (61 kg)
<b>Max spin speed</b>	950 RPM (±50 rpm)

### WARNING

- Moving or installation of the appliance requires two or more people. Failure to follow these instructions may result in injury.
- Store and install the appliance where it will not be exposed to temperatures below freezing or exposed to outdoor weather conditions. Failure to follow this warning can cause product or part failure, serious injury, fire, electric shock, or death.
- Properly ground the washer to conform with all governing codes and ordinances. Failure to follow this warning can cause serious injury, fire, electric shock, or death.
- To reduce the risk of electric shock, do not install the appliance in humid spaces. Failure to follow this warning can cause serious injury, fire, electric shock, or death.
- To ensure proper airflow, do not block the large opening on the bottom of the washer with carpeting or other materials.
- Do not remove the ground prong. Do not use an adapter or extension cord. Plug into a grounded 3-prong outlet. Failure to follow this warning can cause serious injury, fire, electric shock, or death.
- Certain internal parts are intentionally not grounded and may present a risk of electric shock only during servicing. Service personnel-do not contact the following parts while the appliance is energized. : pump, motor, noise filter cover, and heater (on applicable models).

## Choosing the Proper Location

Install the washer on a solid floor that is strong and rigid enough to support the weight of the washer, even when fully loaded, without flexing or bouncing. If the floor has too much flex, you may need to reinforce it to make it more rigid. If the floor is not solid, it may cause severe vibration and noise.

### NOTE

- Before installing the washer, make sure the floor is clean, dry and free of dust, dirt, water and oil so the washer feet cannot slide easily. Leveling feet that can move or slide on the floor can contribute to excess vibration and noise due to poor contact with the floor.
- Allow for sufficient space between the walls and the washer for installation.

## Power Outlet

- The power outlet must be within 60 inches (1.5 m) of either side of the washer.
- The appliance and outlet must be positioned so that the plug is easily accessible.
- Do not overload the outlet with more than one appliance.
- The outlet must be grounded in accordance with current electrical wiring codes and regulations.
- Use a time-delay fuse or circuit breaker.

### NOTE

- It is the personal responsibility and obligation of the product owner to have a proper outlet installed by a qualified electrician.

## Flooring

- To minimize noise and vibration, the washer must be installed on a solidly constructed floor.
- Allowable slope under the entire washer is a maximum 1 inch difference from side to side or from front to back.
- Installing on carpeting and soft tile surfaces is not recommended.
- Never install the washer on a platform or weakly supported structure.

### NOTE

- The washer must be installed on firm flooring to minimize vibration during the spin cycle. Concrete flooring is best, but a wood floor is sufficient, provided it is built to FHA standards.

## Floor Installation

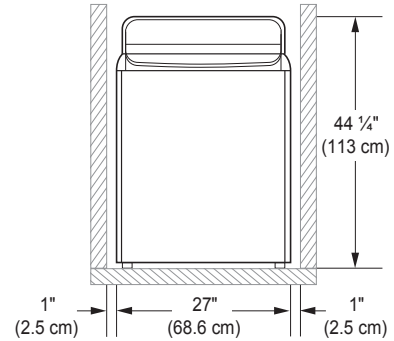

To ensure sufficient clearance for water lines, the drain line and airflow, allow minimum clearances of at least 1 inch (2.5 cm) at the sides and 4 inches (10 cm) behind the unit. Be sure to allow for wall, door, or floor moldings that may increase the required clearances.

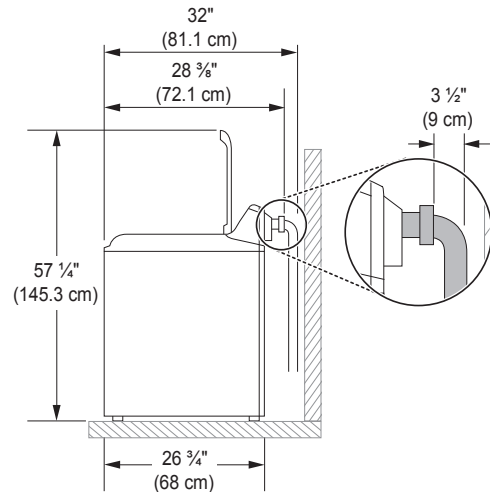

- Minimum vertical space from floor to overhead shelves, cabinets, ceilings, etc., is 58 inches (147 cm).

## Unpacking and Removing Shipping Material

Unpack all shipping materials from the washer for proper operation and inspect it for shipping damage.

### CAUTION

- Failure to remove shipping materials can cause excessive noise and vibration.

#### 1 Lift the washer off the foam base.

After removing the carton and shipping material, lift the washer off the foam base. Make sure the plastic tub support comes off with the base and is not stuck to the bottom of the washer.

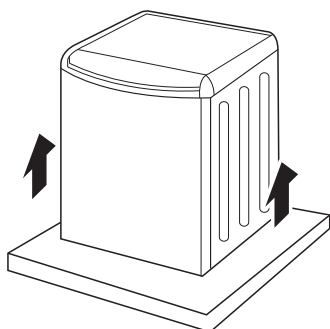

If you must lay the washer down to remove the base packaging materials, always protect the side of the washer and lay it carefully on its side. Do not lay the washer on its front or back.

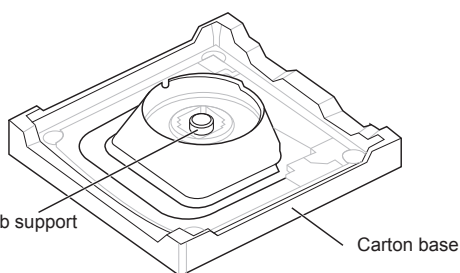

- 2 To prevent damage, do not remove the foam block containing the owner's manual, parts, and laundry product samples from the washer tub until the washer is in the final location.

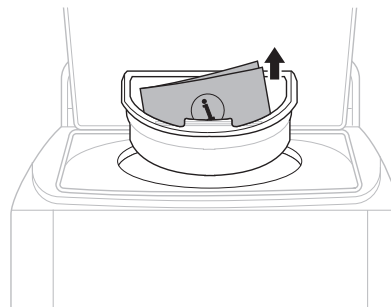

#### NOTE

- Once removed, save the foam block for future use. If the washer needs to be moved, the foam block will help prevent damage during transportation.

- 3 Unfasten the power cord from the back of the washer.

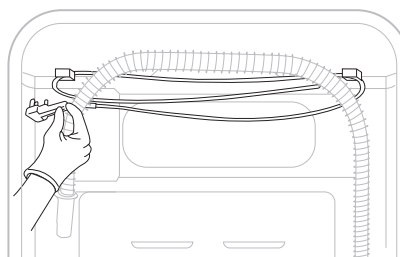

## Connecting the Water Lines

To avoid the risk of costly water damage, purchase and install new inlet hoses when installing the washer.

### 1 Check the fittings and seals.

Inspect the threaded fitting on each hose and make sure there is a rubber seal in place in both ends of each hose to prevent leaking.

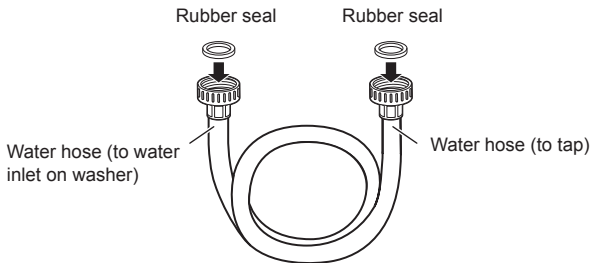

### 2 Connect the water supply hoses.

Connect the water supply hoses to the hot and cold water faucets tightly by hand and then tighten another 2/3 turn with pliers. Connect the blue hose to a cold water faucet and the red hose to a hot water faucet.

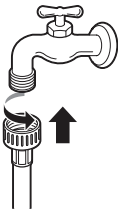

### 3 Flush out the inlet hoses.

After connecting the inlet hoses to the water faucets, turn on the water faucets to flush out foreign substances (dirt, sand or sawdust) in the water lines. Let water drain into a bucket, and check the water temperature to make sure you've connected the hoses to the correct faucets.

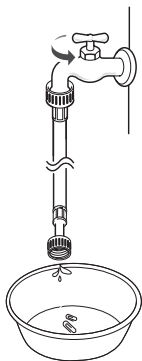

### 4 Attach the water lines to the back of the washer.

Attach the hot water line to the hot water inlet on the back of the washer. Attach the cold water line to the cold water inlet on the back of the washer. Tighten the fittings securely. Turn ON both faucets all the way and check for leaks at both ends of the hoses.

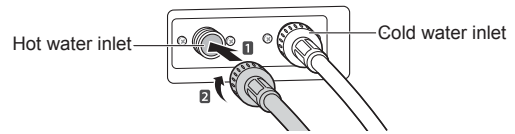

### ! WARNING

- Do not overtighten the hoses or cross-thread the hose fittings. Overtightening or cross-threading can damage the valves or couplings, resulting in leaking and property damage.
- Do not reuse old hoses. Use only new hoses when installing the washer. Old hoses could leak or burst causing flooding and property damage. Contact an LG Customer Information Center for assistance in buying hoses.

### NOTE

- Periodically check the hoses for cracks, leaks, and wear, and replace the hoses every five years. Do not stretch the water hoses intentionally, and make sure that they are not pinched, crushed or kinked by other objects.
- Water supply pressure must be between 20 psi and 120 psi (138 – 827 kPa). If the water supply pressure is more than 120 psi, a pressure reducing valve must be installed.
- To provide optimum washing performance, the hot water temperature should be set at 120 – 135 °F (48 – 57 °C) and the cold at 60 °F (15 °C).
- The washer should never be installed or stored in a location subject to freezing temperatures. Damage to the water lines and internal mechanisms of the washer can result. If the washer was exposed to freezing temperatures prior to installation, allow it to stand at room temperature for several hours before use and check for leaks prior to operation.
- Do not use flood-preventing hoses with auto shutoff devices. The devices can be tripped during fill and prevent the machine from filling properly.

## Connecting the Drain Hose

Connect the drain hose to either a standpipe or laundry tub.

### NOTE

- The drain hose should always be properly secured. Failure to properly secure the drain hose can result in flooding and property damage.
- The drain must be installed in accordance with any applicable local codes and regulations.
- Make sure that the drain hose is not stretched, pinched, crushed, or kinked.
- Do not install the drain hose with the end lower than 29.5 inches (75 cm) or higher than 96 inches (244 cm) above the bottom of the washer or more than 60 inches (152 cm) away from the washer.
- Never create an airtight seal between the hose and the drain with tape or other means. If no air gap is present, water can be siphoned out of the tub resulting in poor wash/rinse performance or clothing damage.
- Normal height of the end of the hose should be approximately 35 inches (89 cm) to 47 inches (120 cm) from the floor.

### Option 1: Standpipe

- 1 Insert the end of the drain hose into the standpipe.
- 2 Use the provided tie strap to secure the drain hose in place.

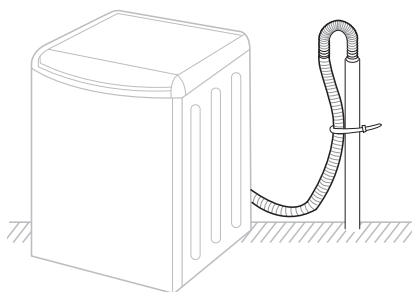

- 3 If the water valves and drain are built into the wall, fasten the drain hose to one of the water hoses with the tie strap provided (ribbed side on inside).

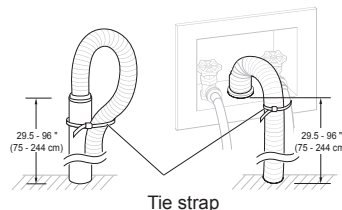

### CAUTION

- Do not insert the end of the drain hose into the standpipe more than 8 inches (20 cm). Doing so can cause siphoning, odors, or improper draining.

### NOTE

- If the drain is large enough for the flange on the hose to fit inside, then do not insert the flange more than 1-2 inches into the drain.

### Option 2: Laundry Tub

- 1 Hang the end of the drain hose over the side of the laundry tub.
- 2 Use the provided tie strap to secure the drain hose in place.

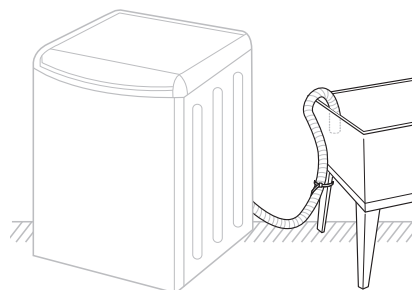

## Leveling the Washer

The tub of the washer spins at very high speeds. To minimize vibration, noise, and unwanted movement, the floor must be a level, solid surface.

### NOTE

- Adjust the leveling feet only as far as necessary to level the washer. Extending the leveling feet more than necessary can cause the washer to vibrate.
- Before installing the washer, make sure that the floor is clean, dry and free of dust, dirt, water and oil so the washer feet cannot slide easily. Feet that move or slide on the floor can contribute to excessive vibration and noise due to poor contact with the floor.

### 1 Position the washer in its final location.

Take special care not to pinch, strain, or crush the water and drain lines. If you have a carpenter's level, you can use it to check that the washer level. The slope beneath the washer should not exceed 1 inch, and all four leveling feet must rest firmly on the floor.

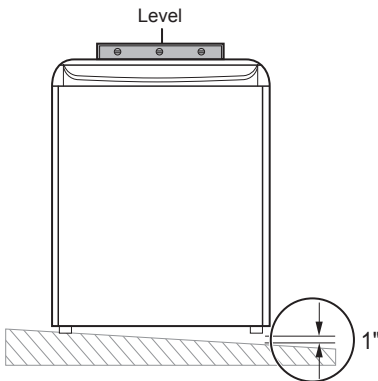

### 2 Open the lid (door) and look from above to see if the tub is centered.

If the tub is NOT centered, readjust the front feet. If you have a level, check the washer with the level.

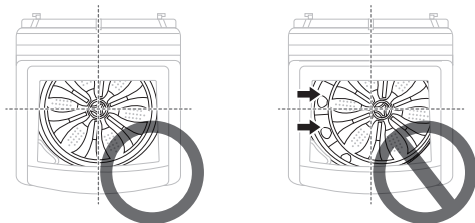

### NOTE

- To check if the washer is level from side to side, place a level on the back edge of the lid (door).
- To check if the washer is level from front to back, place a level at the side of the washer on the edge where the cabinet side meets the top cover. Do not place the level on the top of the lid (door). Using these surfaces will result in the washer being unlevel.

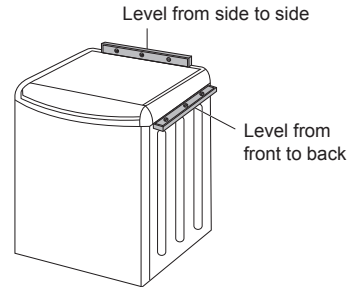

### 3 Adjust the lower leveling feet.

Turn in one direction to raise the washer or the other direction to lower it.

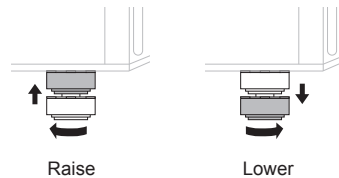

### 4 Recheck the washer's levelness.

Push or rock the top edges of the washer gently to make sure the washer does not rock. If the washer rocks, repeat steps 1-3.

## CAUTION

- Using the washer without leveling it may cause excess vibration and noise, leading to a machine malfunction.
- Extend the leveling feet only to level the washer. If you extend the leveling feet unnecessarily, it may cause abnormal vibration of the washer.

### NOTE

- If the washer is not level, the lid (door) may not stay open properly. If this happens, extend the front leveling legs until the washer is level from front to back.

## Connecting to the Power Supply

The washer should be plugged into a 120-VAC, 60 Hz grounded 3-prong outlet. Plug in the washer.

### WARNING

- Do not use a worn or damaged power cord or power plug. Replace or repair it immediately. Failure to do so may result in death, fire, electric shock, or malfunction.
- Do not modify the power cord and plug provided with the appliance. Do not damage it when installing or moving the washer. Doing so may result in death, fire, electric shock, or malfunction.
- Make sure that the washer is grounded.
- Connect this washer to a grounded outlet conforming to the rating prior to use. Failure to do so may result in fire, electric shock, or malfunction.
- Do not damage or cut off the ground prong of the power cord. Doing so may cause death, fire, electric shock, or product malfunction.
- Improper connection of the equipment-grounding conductor can result in risk of electric shock. Check with a qualified electrician or service technician if you are in doubt as to whether the appliance is properly grounded. If it does not fit the outlet, have a proper outlet installed by a qualified electrician.
- The appliance and outlet must be positioned so that the plug is easily accessible.
- Do not use adapters or extension cords. Doing so may result in serious injury, fire, electric shock, or death.
- For best performance, plug the washer into its own individual outlet. This helps prevent overloading house wiring circuits which could cause a fire hazard from overheated wires.
- If necessary, use a new, UL-listed 3-prong adapter or 3-wire extension cord with a 3-prong (grounding) plug rated at no less than the branch circuit. Do not use an extension cord longer than 3 feet. Failure to follow these warnings may result in serious injury, fire, electric shock, or death.





## Testing the Washer

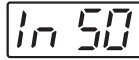
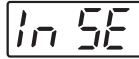

Check if the washer is properly installed and run a test cycle.



- 1 Make sure the tub is empty. Do not load anything in the tub for this test.
- 2 Press the **Power** button.
- 3 Press and hold the **Spin** and **Soil** buttons simultaneously until an  appears in the display.

Display	Information
	Initial test
	Previous test result was good.
	Previous test was ended with an error.

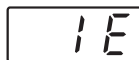
### NOTE

-  is displayed first, and ,  or  is displayed.
  - The indication is different for each model.
- 4 Press the **Start/Pause** button.  
The washer will start the test, which will last about 3 minutes. The test automatically checks the water inlet hoses and the drain hose.
  - 5 Check the display for results.  
If error code is displayed, refer to the following guide.

Error Code	Solution
	Fully open the water faucets. Straighten out any kinks in the inlet hoses and make sure the hoses are not pinned against the wall or under the washer.
	Straighten out any kinks in the drain hose and make sure the hose is not pinned against the wall or under the washer. Remove and flush out the drain hose to remove clogs. Adjust or repair the drain. Maximum drain height is 96 inches.

- 6 End of cycle.  
At the end of the test cycle,  or  will display. The test cycle will end and the washer will shut off automatically after a short delay.