

OWNER'S MANUAL COMBINATION WALL OVEN

Read this owner's manual thoroughly before operating the appliance and keep it handy for reference at all times.

LWC3063**



MFL70581901_01

www.lg.com

Copyright © 2018 LG Electronics Inc. All Rights Reserved.

TABLE OF CONTENTS

3 IMPORTANT SAFETY INSTRUCTIONS

11 PRODUCT OVERVIEW

- 11 Parts
- 11 Accessories

12 OPERATION

- 12 Control Panel Overview
- 14 Changing Oven Settings
 - 14 Clock
 - 14 Timer On/Off
 - 15 Settings
 - Setting the Hour Mode
 - Setting Convection Auto Conversion
 - Adjusting the Oven Temperature
 - Selecting the Display Language
 - Turning the Preheat Alarm Light On/Off
 - Adjusting the Beeper Volume
 - Selecting Fahrenheit or Celsius
 - 16 Demo Mode
 - 16 Lockout
 - 17 Start Time (Delayed Timed Cook)
 - 17 Cook Time (Timed Cook)
- 18 Using the Upper Oven
 - 18 Before Using the Upper Oven
 - 18 Upper Oven Light
 - 18 Microwave Cookware Guide
 - 19 Microwave Cooking Tips
 - 20 Microwave Power Levels
 - 21 +30 seconds
 - 21 Defrost
 - 23 Sensor Operation
 - 23 Using Sensor Cook
 - 25 Convection Bake
 - 25 Broil
 - 26 Speed Cook
 - 26 Auto Cook
 - 30 Soften
 - 31 Melt
 - 32 Warm
 - 32 Proof
 - 32 Popcorn
- 33 Using the Lower Oven
 - 33 Before Using the Lower Oven
 - 33 Lower Oven Light

- 33 Minimum & Maximum Default Settings
- 34 Using Oven Racks
- 34 Bake
- 35 Multi-Rack Baking
- 35 Oven Vent
- 36 Convection Mode
- 37 Broil
- 38 Recommended Broiling Guide
- 39 Steam Function
- 40 Warm
- 41 Proof
- 41 Probe
- 43 Favorite
- 43 Sabbath Mode
- 44 Wi-Fi
- 44 Remote Start

45 SMART FUNCTIONS

- 45 LG SmartThinQ Application
- 46 Smart Diagnosis™ Function
- 48 FCC Notice
- 48 FCC RF Radiation Exposure Statement

49 MAINTENANCE

- 49 Caring for the Upper Oven
 - 49 Cleaning the Interior
 - 49 Cleaning the Exterior
- 50 Caring for the Lower Oven
 - 50 EasyClean®
 - 52 Steam Feeder Tank
 - 52 Cleaning Scale on Oven Bottom
 - 52 Descaling
 - 53 Drying
 - 53 Self Clean
 - 55 Changing the Oven Light
 - 55 Cleaning the Exterior
 - 57 Removing and Replacing the Lift-Off Oven Doors
 - 57 Door Care Instructions

58 TROUBLESHOOTING

- 58 FAQs
- 61 Before Calling for Service

65 LIMITED WARRANTY

IMPORTANT SAFETY INSTRUCTIONS

Read and follow all instructions when using the oven to prevent the risk of fire, electric shock, personal injury, or damage. This guide does not cover all possible conditions that may occur. Always contact your service agent or manufacturer about problems that you do not understand.

Download this owner's manual at: <http://www.lg.com>



This is the safety alert symbol. This symbol alerts you to potential hazards that can result in property damage and/or serious bodily harm or death.

All safety messages will follow the safety alert symbol and either the word WARNING or CAUTION. These words mean:



WARNING - Indicates a hazardous situation which, if not avoided, could result in death or serious injury.



CAUTION - Indicates a hazardous situation which, if not avoided, could result in minor or moderate injury.

IMPORTANT SAFETY INSTRUCTIONS (UPPER OVEN)

When using electrical appliances basic safety precautions should be followed, including the following:

WARNING

- To reduce the risk of burns, electric shock, fire, injury to persons or exposure to excessive microwave energy when using the upper oven, follow basic safety precautions, including the following.
- **Read all the instructions before using the oven.**
- **As with any appliance, close supervision is necessary when used by children.**
- Read and follow the specific **PRECAUTIONS TO AVOID POSSIBLE EXPOSURE TO EXCESSIVE MICROWAVE ENERGY**. Needs reference to location on Page 7.
- Use this appliance only for its intended purpose, as described in the manual.
Do not use corrosive chemicals or vapors, such as sulfide and chloride, in this appliance. This type of oven is specifically designed to heat, cook, or dry food. It is not designed for industrial or laboratory use.
- **Do not store** this appliance outdoors. Do not use this product near water - for example, near a kitchen sink, in a wet basement, near a swimming pool, or similar location.
- **Do not use this oven for commercial purposes.** It is made for household use only.
- **When cleaning surfaces of door and oven that come together on closing the door, use only mild, nonabrasive soaps, or detergents applied with a sponge or soft cloth.**
- **If your oven is dropped or damaged,** have it thoroughly checked by a qualified service technician before using it.
- **To reduce the risk of fire in the oven cavity:**
 - **Do not overcook food.** Carefully attend to the upper oven when paper, plastic or other combustible materials are placed inside the oven to facilitate cooking.
 - **Do not use the cavity for storage purposes.**
Do not leave paper products, cooking utensils or food in the cavity when not in use.
 - Remove wire twist-ties from paper or plastic bags before placing bags in oven.
- **If materials inside the oven ignite:**
 - **Keep oven door closed**
 - **Turn the oven off**
 - **Disconnect the power cord or shut off power at the fuse or circuit breaker panel.**
- **To avoid electric shock:**
 - **This appliance must be grounded.** Connect only to a properly grounded outlet. See the Installation Guide.
 - **Do not operate this appliance if it has a damaged cord or plug,** if it is not working properly or if it has been damaged or dropped.
 - **Do not immerse the electrical cord or plug in water.**
 - **Keep cord away from heated surfaces.**
 - **Do not let cord hang over edge of table or counter.**
- **Take care when the door is opened to avoid injury.**
- **To avoid improperly cooking some foods:**
 - **Do not heat any type of baby bottle or baby food.** Uneven heating may occur and possibly cause personal injury.
 - **Do not heat small-necked containers,** such as syrup bottles.
 - **Do not deep-fat fry in the upper oven.**
 - **Do not attempt home canning in the upper oven.**
 - **Some products such as whole eggs and sealed containers – for example, closed glass jars – are able to explode and should not be heated in this oven.**

 **WARNING**

- Do not cover or block any openings on the appliance.
- Do not run the oven empty.
- Install or locate this appliance only in accordance with the provided installation instructions.
- This appliance should be serviced only by qualified service personnel. Contact the nearest authorized service facility for examination, repair, or adjustment.
- Liquids, such as water, coffee, or tea can be overheated beyond the boiling point without appearing to be boiling due to surface tension of the liquid. Visible bubbling or boiling when the container is removed from the upper oven is not always present.

THIS COULD RESULT IN VERY HOT LIQUIDS SUDDENLY BOILING OVER WHEN THE CONTAINER IS DISTURBED OR A SPOON OR OTHER UTENSIL IS INSERTED INTO THE LIQUID.

- To reduce the risk of injury to persons;
 - Do not overheat the liquid.
 - Stir the liquid both before and halfway through heating it.
 - Do not use straight-sided containers with narrow necks.
 - After heating, allow the container to stand in the upper oven for a short time before removing the container.
 - Use extreme care when inserting a spoon or other utensil into the container.
- Do not use the oven for the purpose of dehumidification (for example, operating the upper oven with wet newspapers, clothes, toys, electric devices, plants, soil, pets or any other living matter inside it). The oven must only be used for heating or cooking food.
 - The results of misuse can include safety risks such as fire, burns, or death due to electric shock.
- This appliance is not intended for use by persons (Including children) with reduced physical, sensory or mental capabilities, or lack of experience and knowledge, unless they have been given supervision or instruction concerning use of the appliance by a person responsible for their safety. Children should be supervised to ensure that they do not play with the appliance.
 - Improper use may cause damage such as a fire, electric shock or burn.
- Accessible parts may become hot during use. Young children should be kept away to keep them from touching hot surfaces and being burned.
- Children must not be allowed to play with accessories or hang down from the door or any part of the oven.
 - Doing so can cause serious injury and damage.
- If the door or door seals are damaged, the oven must not be operated until it has been repaired by a competent person.
- The appliance and its accessible parts become hot during use. Care should be taken to avoid touching heating elements. Children shall be kept away unless continuously supervised.
- Do not use recycled paper products.
 - They may contain impurities which may cause sparks and/or fires when used in cooking.
- Do not rinse trays and racks by placing them in water just after cooking. This may cause breakage or damage.
 - Improper use could result in damage to the oven.

⚠ WARNING

- The oven should be cleaned regularly and any food deposits should be removed.
 - Failure to maintain the oven in a clean condition could lead to deterioration of the surface that could adversely affect the life of the appliance and possibly result in a hazardous situation.
- The door or the outer surface may get hot when the appliance is operating.
- Liquids heated in certain shaped containers (especially cylindrical-shaped containers) may become overheated. The liquid may splash out with a loud noise during or after heating or when adding ingredients (instant coffee. etc.), resulting in harm to the oven and possible injury. In all containers, for best results, stir the liquid several times before heating. Always stir liquid several times between reheatings.
- Arcing can occur during both Speed Cook and Microwave cooking. If arcing occur, press the Clear/Off pad and correct the problem.
- Do not use coverings, containers or cooking bags made of foil, plastic, wax or paper when speed cooking.
- Place food directly on the trays when cooking unless prompted by the oven to do otherwise.
- Not all plastic wrap is suitable for use in upper ovens.
- Make sure to use suitable cookware during microwave cooking.
 - Use microwave-safe plastics only and use them in strict compliance with the cookware manufacturer's recommendations.
 - Do not microwave empty containers.
 - Do not permit children to use plastic cookware without complete supervision.

FEDERAL COMMUNICATIONS COMMISSION RADIO FREQUENCY INTERFERENCE STATEMENT (U.S.A. ONLY)

This equipment generates and uses ISM frequency energy and if not installed and used properly, that is in strict accordance with the manufacturer's instructions, may cause interference to radio and television reception. It has been type tested and found to comply with limits for ISM Equipment pursuant to part 18 of FCC Rules, which are designed to provide reasonable protection against such interference in a residential installation.

However, there is no guarantee that interference will not occur in a particular installation. If this equipment does cause interference to radio or television reception, which can be determined by turning the equipment off and on, the user is encouraged to try to correct the interference by one or more of the following:

- Reorient the receiving antenna of the radio or television.
- Relocate the upper oven with respect to the receiver.
- Move the upper oven away from the receiver.
- Plug the upper oven into a different outlet so that the upper oven and the receiver are on different branch circuits.

The manufacturer is not responsible for any radio or TV interference caused by unauthorized modification to this upper oven. It is the responsibility of the user to correct such interference.

PRECAUTIONS TO AVOID POSSIBLE EXPOSURE TO EXCESSIVE MICROWAVE ENERGY

- Do not attempt to operate this oven with the door open since open-door operation can result in harmful exposure to microwave energy. It is important not to defeat or tamper with the safety interlocks.
- Do not place any object between the oven front face and the door or allow soil or cleaner residue to accumulate on sealing surfaces.
- Do not operate the oven if it is damaged.
It is particularly important that the oven door closes properly and that there is no damage to the:
(1) door (bent),
(2) hinges and latches (broken or loosened),
(3) door seals and sealing surfaces.
- The oven should not be adjusted or repaired by anyone except properly qualified service personnel.

SAFETY PRECAUTIONS (LOWER OVEN)

- **DO NOT TOUCH HEATING ELEMENTS OR INTERIOR SURFACES OF OVEN.** Heating elements may be hot even though they are dark in color. Interior surfaces of an oven become hot enough to cause burns. During and after use, do not touch or let clothing or other flammable materials contact heating elements or interior surfaces of oven until they have had sufficient time to cool. Other surfaces, such as oven vent openings and surfaces near these openings, oven doors, and windows of oven doors, also get hot and may cause burns if not allowed to cool.
- **Use care when opening door.** The hot air and steam that escape can cause burns to hands, face and eyes. Let hot air or steam escape from the oven before removing or replacing food in the oven.
- Be sure your appliance is properly installed and grounded by a qualified technician.
- Do not repair or replace any part of the appliance unless specifically recommended in the manual. All other servicing should be performed by a qualified technician.
- Do not use harsh etching, abrasive cleaners or sharp metal scrapers to clean the oven door glass since they can scratch the surface. Scratches may cause the glass to shatter.
- Do not leave items such as paper, cookware or food in the oven when not in use.
- Do not use this oven for purposes other than cooking.
- Never use paper products in the convection oven.
- Do not open the door when the oven is operating.
- Use oven gloves when removing the food and accessories after cooking as the oven & accessories will be very hot.
- Scratching, hitting, jarring, or stressing the glass may weaken its structure causing an increased risk of breakage at a later time.



WARNING

If the door glass or oven heating unit of the oven are damaged, discontinue use of the oven and call for service.

- Do not use plastic to cover food. Use foil or oven-safe lids only.
- Do not allow anyone to climb, stand or hang on the oven door. They could damage the oven and even tip it over, causing severe personal injury.
- Do not line the oven walls, racks, bottom, or any other part of the oven with aluminum foil or any other material. Doing so will disrupt heat distribution, produce poor baking results and cause permanent damage to the oven interior (aluminum foil will melt to the interior surface of the oven)

- Never attempt to dry a pet in the oven.
- **Never use your appliance for warming or heating the room.**
- Always use pot holders or oven mitts when removing food from the oven. Cookware will be hot. **Use only dry pot holders.** Moist or damp pot holders on hot surfaces may result in burns from steam. Do not let the pot holder touch hot heating elements. Do not use a towel or other bulky cloth to remove food.
- **Do not heat unopened food containers.** Pressure in the containers may cause them to burst which may result in injury.
- **Keep Oven Vent Ducts Unobstructed.**
The oven vent could become hot during oven use. Never block this vent and never place plastic or heat-sensitive items on or near the vent.

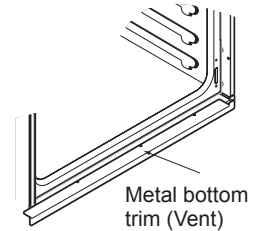

FLAMMABLE MATERIALS

WARNING

Be certain that all packing materials are removed from the appliance before operating. Keep plastic, clothes, paper, and other flammable materials away from parts of the appliance that may become hot.

- Do not store or use flammable material in the oven. Flammable materials include paper, plastic, pot holders, linens, wall coverings, curtains, and gasoline or other flammable vapors and liquids such as grease or cooking oil. These materials can be ignited when the oven is in use.
- **Wear proper apparel.** Do not wear loose-fitting or hanging garments, which may ignite if they contact hot surfaces, and cause severe burns.
- Do not use the oven for drying clothes. Only use the oven for its intended purpose.
- If a cabinet storage is provided directly above the ovens, place items that are not frequently used and can be safely stored in an area subjected to heat. Temperatures may be unsafe for volatile items such as flammable liquids, cleaners or aerosol sprays.

ELECTRICAL SAFETY

CAUTION

Be certain that all packing materials are removed from the appliance before operating. Keep plastic, clothes, paper, and other flammable materials away from parts of the appliance that may become hot.

- Always disconnect power from the appliance before servicing.
- Do not use aluminum foil or any other material to line the oven bottom. Improper installation of these liners may result in a risk of electric shock or fire.
- Do not allow aluminum foil or the temperature probe to contact heating elements.

WARNING

Before replacing the oven light bulb, switch off the electrical power to the oven at the main fuse or circuit breaker panel. Failure to do so can result in severe personal injury, death, or electrical shock.

CHILD SAFETY

- Do not touch the hot surface between the upper oven door and the lower oven door on the front of the oven while the oven is in operation. The surface becomes hot and can cause burns and other injury.
- Do not leave small children unattended near the oven.



WARNING

Do not leave children alone or unsupervised near the appliance when it is in use or is still hot. Children should never be allowed to sit or stand on any part of the appliance as they could be injured or burned.

- Never let a child hang on the oven door.
- Do not allow children to crawl into the oven.
- Let hot utensils cool in a safe place, out of reach of small children.
- Children should not be allowed to play with controls or other parts of the appliance.

ENERGY SAVING TIPS

- Multiple-rack cooking saves time and energy. Whenever possible, cook foods requiring the same cooking temperature together in one oven.
- For optimal performance and energy savings, follow the guides for proper rack and pan placements.
- Reduce energy use by cleaning light oven soils with the EasyClean® feature instead of self-clean.
- Avoid opening the oven door more than necessary during use. This helps the oven maintain temperature, prevents unnecessary heat loss, and saves on energy use.

SAFETY DURING USE

- Do not touch the oven racks while they are hot.
- Always place oven racks in desired location while oven is cool. If a rack must be moved while the oven is hot, do not let the pot holder contact the hot heating element in the oven.
- Use caution with the Timed Cook or Delayed Timed Cook features. Use the automatic timer when cooking cured or frozen meats and most fruits and vegetables. Foods that can easily spoil, such as milk, eggs, fish, meat or poultry, should be chilled in the refrigerator first. Even when chilled, they should not stand in the oven for more than 1 hour before cooking begins, and should be removed promptly when cooking is complete. Eating spoiled food can result in sickness from food poisoning.
- Accessible parts may become hot when the grill is in use.
- Do not place food or cookware on the bottom of the oven cavity. Doing so will cause permanent damage to the oven bottom finish.
- **Do not use water on grease fires.** Should an oven fire occur, leave the oven door closed and turn the oven off. If the fire continues, throw baking soda on the fire or use a fire extinguisher. Do not put water or flour on the fire. Flour may be explosive and water can spread a grease fire and cause personal injury.
- Pull the oven rack to the stop-lock position when loading and unloading food from the oven. This helps prevent burns caused by touching hot surfaces of the door and oven walls.
- Do not put your hand under the controller or between the door and metal bottom trim (vent) during operation.
The outside of the oven can become very hot to the touch.

- Do not use the oven if a heating element develops a glowing spot during use or shows other signs of damage. A glowing spot indicates the heating element may fail and present a potential burn, fire, or shock hazard. Turn the oven off immediately and have the heating element replaced by a qualified service technician.
- When using cooking or roasting bags in the oven, follow the manufacturer's directions.

SAFETY WHEN CLEANING

- Open a window or turn on a ventilation fan or hood before self-cleaning.
- If the oven is heavily soiled with oil, self-clean the oven before using the oven again. The oil could cause a fire.
- Wipe up heavy soil on the bottom of the oven before using the Self Clean function.
- **Do not use oven cleaners.** Commercial oven cleaner or oven liner protective coating of any kind should not be used in or around any part of the oven.
- Never keep pet birds in the kitchen. The health of birds is extremely sensitive to the fumes released during an oven self-clean cycle. Fumes may be harmful or fatal to birds. Move birds to a well-ventilated room.
- Clean in the self-clean cycle only parts listed in this manual. Before self-cleaning the oven, remove the broiler pan, all oven racks, the meat probe and any utensils or food from the oven.
- Important Instruction. The oven displays an F error code and sounds three long beeps during the self-cleaning process if it malfunctions in the self-clean mode. Switch off the electrical power to the main fuse or breaker and have the oven serviced by a qualified technician.
- Never pour cold water over a hot oven for cleaning. Doing so may cause the oven to malfunction.
- Make sure oven lights are cool before cleaning.
- **Do not clean door gasket.** The door gasket is essential for a good seal. Care should be taken not to rub, damage, or move the gasket.
- If there is a fire in the oven during self-clean, turn the oven off and wait for the fire to go out. Do not force the door open. Introduction of fresh air at self-clean temperatures may lead to a burst of flame from the oven. Failure to follow this instruction may result in severe burns.
- **DO NOT block the oven vent during operation.** This can damage the electric parts of the oven. Air must be able to move freely. The metal bottom trim (vent) should be properly assembled on the front bottom of oven before installing the oven door.

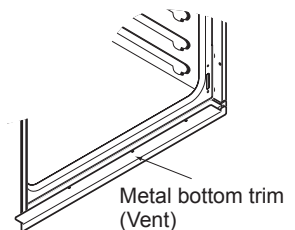

COOK MEAT AND POULTRY THOROUGHLY

- To protect against food-borne illnesses, cook meat and poultry thoroughly. The USDA has indicated the following as safe minimum internal temperatures for consumption:
 - Ground beef: 160 °F
 - Poultry: 165 °F
 - Beef, veal, pork, or lamb: 145 °F
 - Fish/seafood: 145 °F

PRODUCT OVERVIEW

Parts

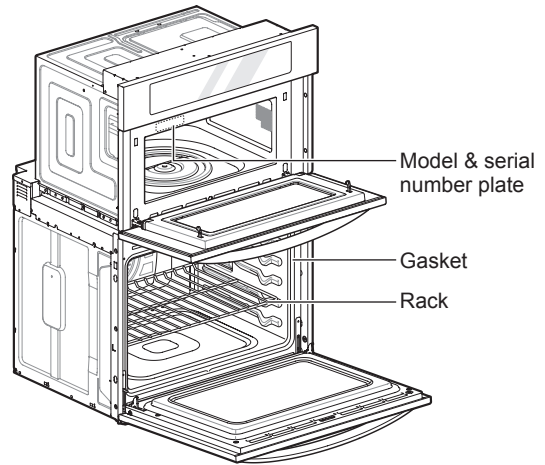
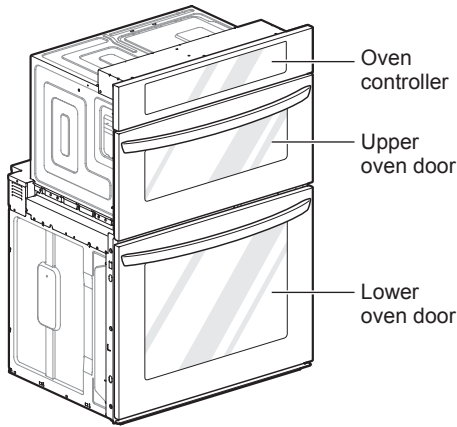

Accessories

Accessories for Upper Oven

The turntable rotates in both directions to help food cook more evenly. Do not operate the microwave oven without the glass tray in place.

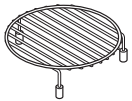

Rack
(For the Convection Bake, Broil and Speed Cook function)

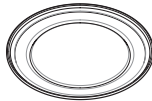

Metal Tray
(For the Convection Bake, Broil and Speed Cook function)



Glass Tray
(For the Microwave and Defrost function)



Shaft



Rotating Ring

Accessories for Lower Oven

Included Accessories



Standard rack (2ea)

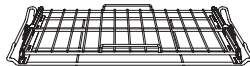

Gliding rack (1ea)



Grid (1ea)

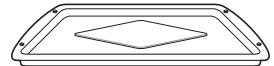

Broiler Pan (1ea)

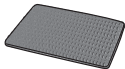

Non-scratch scouring pad (1ea)

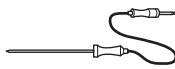

Meat probe (1ea)

Accessories for Installation



Wood Screws - Black (4X14) (6ea)
For Lower Mounting
(4 needed for installation and 2 extra's)



Wood Screws - Silver (4X14) (6ea)
For Upper Mounting
(4 needed for installation and 2 extra's)

NOTE

- Contact LG Customer Service at 1-800-243-0000 if any accessories are missing.
- For your safety and for extended product life, only use authorized components.
- The manufacturer is not responsible for product malfunction or accidents caused by the use of separately purchased, unauthorized components or parts.
- The images in this guide may be different from the actual components and accessories, which are subject to change by the manufacturer without prior notice for product improvement purposes.

OPERATION

Control Panel Overview

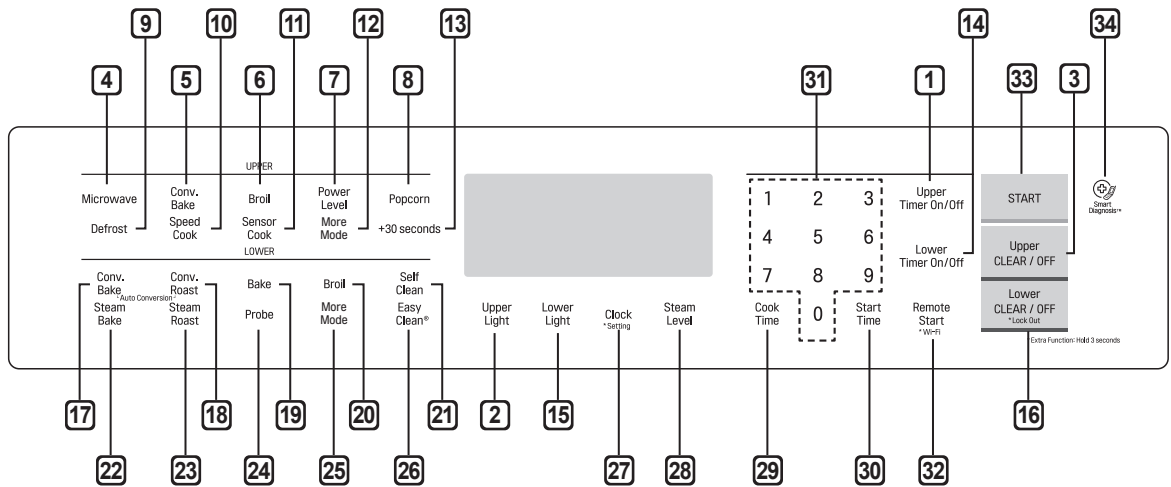

UPPER OVEN

1 Upper Timer On/Off

Use to set or cancel the timer of the upper oven.

2 Upper Light

Use to turn the oven lights of the upper oven on and off.

3 Upper Clear/Off

Use to stop cooking, cancel settings of the upper oven.

4 Microwave

Use to select the Microwave function of the upper oven.

5 Conv. Bake

Use to select the Convection Bake function of the upper oven.

6 Broil

Use to select the Broil function of the upper oven.

7 Power Level

Use to select a cooking power level.

8 Popcorn

Use to select the Popcorn function of the upper oven.

9 Defrost

Use to select the Defrost function of the upper oven.

10 Speed Cook

Use to select the Speed Cook function of the upper oven.

11 Sensor Cook

Use to select the Sensor Cook function of the upper oven.

12 More Mode

Use to select the More Mode function of the upper oven.

13 +30 seconds

Use to add 30 seconds of cooking time each time you touch it.

LOWER OVEN**14 Lower Timer On/Off**

Use to set or cancel the timer of the lower oven.

15 Lower Light

Use to turn the oven lights of the lower oven on and off.

16 Lower Clear/Off

Use to stop cooking, cancel settings of the lower oven. Press and hold button for three seconds to activate LOCKOUT.

17 Conv. Bake

Use to select the Convection Bake function of the lower oven.

18 Conv. Roast

Use to select the Convection Roast function of the lower oven.

19 Bake

Use to select the Bake function of the lower oven.

20 Broil

Use to select the Broil function of the lower oven.

21 Self Clean

Use to select the Self Clean function of the lower oven.

22 Steam Bake

Use to select the Steam Bake function of the lower oven.

23 Steam Roast

Use to select the Steam Roast function of the lower oven.

24 Probe

Use to select the Probe function of the lower oven.

25 More Mode

Use to select the More Mode function of the lower oven.

26 EasyClean®

Use to select the Easy Clean function of the lower oven.

COMMON**27 Clock**

Use to set the time of day. Press and hold button for three seconds to select and adjust oven settings.

28 Steam Level

Use to select and adjust steam level.

29 Cook Time

Use to set the length of the cook time. (Bake, Conv. Bake/Roast only)

30 Start Time

Use to set delay time. (Bake, Conv. Bake/Roast, Self Clean only)

31 Number Pads

Use to enter a temperature and all times.

32 Remote Start

Use to select the Remote Start function. Press and hold button for three seconds to connect it to a Wi-Fi network.

33 Start

Use to START all functions in the oven.

34 Smart Diagnosis™

Use with the Smart Diagnosis feature.

Flashing Time

If your oven displays a flashing clock, touch **Clock** and reset the time, or touch any key to stop the flashing.

Changing Oven Settings

Clock

The clock must be set to the correct time of day in order for the automatic oven timing functions to work properly.

- 1 Touch **Clock**. The display shows **CLO** in red.
- 2 Touch the numbers to enter the time. For example, to set the clock for 10:30, touch the numbers: **1**, **0**, **3** and **0**.
- 3 Touch **Start**.

NOTE

- The time of day cannot be changed during a timed baking or self-clean cycle.
- To check the time of day when the display is showing other information, touch **Clock**.
- If no other keys are touched within 25 seconds of touching **Clock**, the display reverts to the original setting.
- If the display time is blinking, you may have experienced a power failure. Reset the time.

Timer On/Off

The Upper or Lower Timer On/Off serves as an extra timer in the kitchen that beeps when the set time has run out. It does not start or stop cooking.

The Upper or Lower Timer On/Off feature can be used during any of the other oven control functions. The Upper and Lower Timer can be operated independently of each other.

Setting the Timer

For example, to set 5 minutes

- 1 Touch **Upper Timer On/Off** or **Lower Timer On/Off** once.
0:00 appears and **Timer** flashes in the display.
- 2 Touch **5**.
0:05 appears in the display.
- 3 Touch **Timer On/Off** to start the Timer. The remaining time countdown appears in the display.

NOTE

If **Upper Timer On/Off** or **Lower Timer On/Off** is not touched, the timer returns to the time of day.

- 4 When the set time runs out, **End** shows in the display. The indicator tones sound every 15 seconds until **Upper Timer On/Off** or **Lower Timer On/Off** is touched.

NOTE

- If the remaining time is not in the display, recall the remaining time by touching **Upper Timer On/Off** or **Lower Timer On/Off**.
- Touch **Upper Timer On/Off** or **Lower Timer On/Off** twice to set the time in minutes and seconds.
- Touch **Upper Timer On/Off** or **Lower Timer On/Off** once to set the time in hours and minutes.

Canceling the Timer

- 1 Touch **Upper Timer On/Off** or **Lower Timer On/Off** once.
The display returns to the time of day.

Settings

Press and hold **Clock** key for three seconds to select and adjust oven settings.

The **Setting** key allows you to:

- set the hour mode on the clock (12 or 24 hours)
- enable/disable convection auto conversion
- adjust the oven temperature
- select display language
- activate/deactivate the preheating alarm light
- set the beeper volume
- switch the temperature scale between Fahrenheit and Celsius
- disable/enable demo mode

Setting the Hour Mode

The control is set to use a 12-hour clock. To reset the clock to 24-hour mode, follow the steps below.

- 1 Touch and hold **Clock** until **CLO** appears in the display.
- 2 Touch **1** to select a 12-hour clock, or **2** to select a 24-hour clock.
- 3 Touch **Start** to accept the change.

Setting Convection Auto Conversion

(Only for Lower Oven)

When **Conv. Bake** and **Conv. Roast** are selected, Convection Auto Conversion automatically converts the standard recipe temperature entered to a convection temperature by subtracting 25 °F / 14 °C. This auto-converted temperature shows on the display. For example, select **Conv. Bake**, enter 350 °F, and 325 °F shows on the display after preheat.

Convection Auto Conversion is enabled by default. To change the setting, follow these instructions.

- 1 Touch and hold **Clock** until **CLO** appears in the display. Then touch **Clock** repeatedly until **Auto** appears in the display.
- 2 Touch **1** to enable or **2** to disable auto conversion.
- 3 Touch **Start** to accept the change.

Adjusting the Oven Temperature

(Only for Lower Oven)

Your new oven may cook differently from the one it replaced. Use your new oven for a few weeks to become more familiar with it before changing the temperature settings. If after familiarizing yourself with the new oven, you still think that it is too hot or too cold, you can adjust the oven temperature yourself.

NOTE

To begin, either raise or lower the thermostat 15 °F (8 °C). Try the oven with the new setting. If the oven still needs adjustment, raise or lower the thermostat again, using the first adjustment as a gauge. For example, if the adjustment was too much, raise or lower the thermostat 10 °F (5 °C). If the adjustment was not enough, raise or lower the thermostat 20 °F (12 °C). Proceed in this way until the oven is adjusted to your satisfaction.

- 1 Touch and hold **Clock** until **CLO** appears in the display. Then touch **Clock** repeatedly until **L_AJ** appears in the display.
- 2 Use the number keys to enter the number of degrees you want to adjust the oven temperature.
- 3 Adjust the temperature either up or down by touching **Clock** repeatedly to toggle between plus (+) or minus (-).
- 4 Touch **Start** to accept the change.

NOTE

- This adjustment does not affect the broiling or Self Clean temperatures. The adjustment is retained in memory after a power failure. The oven temperature can be increased (+) or decreased (-) as much as 35 °F or 19 °C.
- Once the temperature is increased or decreased, the display shows the adjusted temperature until it readjusts.

Selecting the Display Language

The oven control is set to display in English but can be changed to display in Spanish or French.

- 1 Touch and hold **Clock** until **CLO** appears in the display. Then touch **Clock** repeatedly until **Lng** appears in the display.
- 2 Touch **1** for English, **2** for Spanish, or **3** for French.
- 3 Touch **Start** to accept the change.

Turning the Preheat Alarm Light On/Off

(Only for Lower Oven)

When the oven reaches its set-temperature, the preheating alarm light flashes 5 times or until the oven door is opened.

You can activate or deactivate the preheating alarm light.

- 1 Touch and hold **Clock** until **CLO** appears in the display. Then touch **Clock** repeatedly until **PrE** appears in the display.
- 2 Touch **1** to turn on and **2** to turn off the alarm.
- 3 Touch **Start** to accept the change.

Adjusting the Beeper Volume

- 1 Touch and hold **Clock** until **CLO** appears in the display. Then touch **Clock** repeatedly until **BEEP** appears in the display.
- 2 Touch **1** for Loud, **2** for Low, and **3** for Mute.
- 3 Touch **Start** to accept the change.

Selecting Fahrenheit or Celsius

Set the oven temperature display to show either Fahrenheit (°F) or Celsius (°C) units. The oven defaults to Fahrenheit unless changed by the user.

- 1 Touch and hold **Clock** until **CLO** appears in the display. Then touch **Clock** repeatedly until **Unit** appears in the display.
- 2 Touch **1** for °F (Fahrenheit) or **2** for °C (Celsius).
- 3 Touch **Start** to accept the change.

Demo Mode

Demo Mode for showroom use only. The oven will not heat up.



- 1 Touch and hold **Clock** until **CLO** appears in the display. Then touch **Clock** repeatedly to select demo mode.
- 2 Touch **1** to enable and **2** to disable the demo mode.
- 3 Touch **Start** to accept the change.

NOTE

- When Demo Mode is on, the appliance will not heat up.
- The oven Demo Mode icon appears in the display if the Demo Mode is on.

Lockout

The Lockout feature automatically locks the lower oven door and prevents most oven controls on both ovens from being turned on. It does not disable the clock, timer or the interior oven light.

- 1 Touch and hold **Lower Clear/Off** for three seconds.
- 2 The lock melody sounds, **OVEN LOCKOUT** appears in the display and the lock  blinks in the display.
- 3 Once the oven door is locked, the lock  indicator stops blinking and remains on.
- 4 To deactivate the Lockout feature, touch and hold **Lower Clear/Off** for three seconds. The unlock melody sounds and the door and the controls unlock.

Start Time (Delayed Timed Cook)

The automatic timer of the Delayed Timed Cook function turns the oven on and off at the time you select. This feature can be used with the **Bake, Conv. Bake** and **Conv. Roast** modes.

Setting a Delayed Timed Cook

For example, to bake at 300 °F and delay the start of baking until 4:30, first set the clock for the correct time of day.

- 1 Touch **Bake**. 350 °F appears in the display.
- 2 Set the temperature: touch **3, 0** and **0**.
- 3 Touch **Cook Time** and set the baking time.
- 4 Touch **Start Time**.
- 5 Set the start time: touch **4, 3** and **0** for 4:30.
- 6 Touch **Start**. A short beep sounds and **Delay Timed** and the start time appear in the display. The oven begins baking at the set start time.

NOTE

- To cancel the Delayed Timed Cook function, touch **Clear/Off** at any time.
- To change the cooking time, repeat step 3 and touch **Start**.
- If the oven clock is set as a 12-hour clock, you can delay the cook time for 12 hours. If the oven clock is set as a 24-hour clock, you can delay the cook time for 24 hours.

The oven will continue to cook for the set amount of time and then turn off automatically. When the cooking time has elapsed:

- **End** and the time of day show in the display.
- The cook end indicator tone sounds every 60 seconds until **Clear/Off** is touched.



CAUTION

- Use the automatic timer when cooking cured or frozen meats and most fruits and vegetables. Foods that can easily spoil, such as milk, eggs, fish, meat or poultry, should be chilled in the refrigerator. Even when chilled, they should not stand in the oven for more than 1 hour before cooking begins, and should be removed promptly when cooking is completed.
- Eating spoiled food can result in sickness from food poisoning.

Cook Time (Timed Cook)

Set the oven to cook for a specific length of time using the Timed Cook feature. This feature can only be used with the **Speed Cook, Bake, Conv. Bake** and **Conv. Roast** modes.

Setting the Cook Time Function

For example, to bake at 300 °F for 30 minutes, first set the clock to the correct time of day.

- 1 Touch **Bake**. 350 °F appears in the display.
- 2 Set the temperature. Touch **3, 0** and **0**.
- 3 Touch **Cook Time**. **Timed** flashes in the display. **Bake**, 0:00 and 300 °F appear in the display.
- 4 Set the baking time: touch **3** and **0** (for 30 minutes). The baking time can be set for any amount of time between 1 minute and 11 hours and 59 minutes.
- 5 Touch **Start**.

The oven will continue to cook for the set amount of time and then turn off automatically. When the cooking time has elapsed:

- **END OF CYCLE** and the time of day show in the display.
- The cook end indicator tone sounds every 60 seconds until **Clear/Off** is touched.

Changing the Cook Time during Cooking

For example, to change the cook time from 30 minutes to 1 hour and 30 minutes, do the following.

- 1 Touch **Cook Time**.
- 2 Change the baking time: touch **1, 3, 0**.
- 3 Touch **Start** to accept the change.

Using the Upper Oven

Before Using the Upper Oven

NOTE

- To avoid risk of personal injury or property damage, do not use stoneware, metal cookware, or metal rimmed cookware in the oven.
- To program the oven, make sure you touch the center of each key firmly since the areas between the keys will not activate the oven. A tone will sound each time a key is touched correctly. Don't touch several keys at once.
- Do not strike the control panel with silverware, cookware, etc. Breakage may occur.
- Always use caution when taking cookware out of the oven. Some dishes absorb heat from the cooked food and may be hot. See Cookware Guide earlier in this section for more information.

NOTE

- Do not rinse containers by placing them in water immediately after cooking. This may cause breakage. Also, always allow the turntable to cool before removing it from the oven.
- Never operate the oven when it is empty. Food or water should always be in the oven during operation to absorb the microwave energy.
- Do not use the oven to dry newspapers or clothes. They may catch fire.
- Use thermometers that have been approved for microwave oven cooking.
- The turntable must always be in place when you operate the oven.
- Do not use your microwave oven to cook eggs in the shell. Pressure can build up inside the shell, causing it to burst.

Upper Oven Light

- 1 Touch **Upper Light** to turn the upper oven light on or off.

Microwave Cookware Guide

Use	Do Not Use
<p>OVENPROOF GLASS (treated for high intensity heat): utility dishes, loaf dishes, pie plates, cake plates, liquid measuring cups, casseroles and bowls without metallic trim.</p> <p>CHINA: bowls, cups, serving plates, and platters without metallic rims.</p> <p>PLASTIC: Plastic wrap (as a cover)- lay the plastic wrap loosely over the dish and press it to the sides. Vent plastic wrap by turning back one edge slightly to allow excess steam to escape. The dish should be deep enough so that the plastic wrap will not touch the food. As the food heats it may melt the plastic wrap wherever the wrap touches the food. Use plastic dishes, cups, semi-rigid freezer containers and plastic bags only for short cooking time. Use these with care because the plastic may soften from the heat of the food.</p> <p>PAPER: Paper towels, waxed paper, paper napkins, and paper plates with no metallic rim or design. Check the manufacturer's label before using in the microwave oven.</p> <p>NOTE: Do not use recycled paper products in the microwave oven. They sometimes contain impurities that cause arcing and sparking.</p>	<p>METAL CONTAINERS: Metal shields the food from microwave energy and produces uneven cooking. Also avoid metal skewers, thermometers, or foil trays. Metal containers can cause arcing, which can damage the microwave oven.</p> <p>METAL DECORATION: Metal-rimmed or metal-banded dinnerware, casserole dishes, etc. The metal rim interferes with normal cooking and may damage the oven.</p> <p>ALUMINUM FOIL: Avoid large sheets of aluminum foil because they hinder cooking and may cause harmful arcing. Use small pieces of foil to shield poultry legs and wings. Keep ALL aluminum foil at least 1 inch from the side walls and door of the oven.</p> <p>WOOD: Wooden bowls and boards will dry out and may split or crack when you use them in the microwave oven. Baskets react in the same way.</p> <p>TIGHTLY COVERED COOKWARE: Be sure to leave openings for steam to escape from covered containers. Pierce plastic pouches of vegetables or other food items before cooking. Tightly closed pouches could explode.</p> <p>BROWN PAPER: Avoid using brown paper bags. They absorb too much heat and could burn.</p> <p>FLAWED OR CHIPPED COOKWARE: Any container that is cracked, flawed, or chipped may break in the oven.</p> <p>METAL TWIST TIES: Remove metal twist ties from plastic or paper bags. They become hot and could cause a fire.</p>

Microwave Cooking Tips

Keeping an Eye on Things

Always watch your food while it cooks. The light inside the upper oven turns on automatically when the oven is cooking so you can monitor the cooking process. Directions given in recipes to elevate, stir, and the like should be thought of as the minimum steps recommended. If the food seems to be cooking unevenly, simply make the necessary adjustments you think appropriate to correct the problem.

Factors Affecting Microwave Cooking Times

Many factors affect cooking times. The temperature of ingredients used in a recipe makes a big difference in cooking times. For example, a cake made with ice-cold butter, milk, and eggs will take considerably longer to bake than one made with ingredients that are at room temperature. Some recipes, particularly those for bread, cake, and custards, recommend that food be removed from the oven when they are slightly undercooked.

This is not a mistake. When allowed to stand, usually covered, these foods will continue to cook outside of the oven as the heat trapped within the outer portions of the food gradually travels inward. If the food is left in the oven until it is cooked all the way through, the outer portions will become overcooked or even burnt. Practice will improve your ability to estimate both cooking and standing times for various foods.

Density of Food

Light, porous food such as cakes and breads cook more quickly than heavy, dense foods such as roasts and casseroles. You must take care when microwaving porous food so that the outer edges do not become dry and brittle.

Height of Food

The upper portion of tall foods, particularly roasts, will cook more quickly than the lower portion.

Therefore, it is wise to turn tall food several times during cooking.

Moisture Content of Food

Because the heat generated from microwaves causes moisture to evaporate, relatively dry food such as roasts and some vegetables should either be sprinkled with water prior to cooking or covered to retain moisture.

Bone and Fat Content of Food

Bones conduct heat and fat cooks more quickly than meat. Care must be taken when cooking bony or fatty cuts of meat in order to prevent unevenly cooked or overcooked meat.

Quantity of Food

The number of microwaves in your oven remains constant regardless of how much food is being cooked. Therefore, the more food you place in the oven, the longer the required cooking time. Remember to decrease cooking times by at least one third when halving a recipe.

Shape of Food

Microwaves penetrate only about 3/4 of an inch (2 cm) into food. The interior portion of thick foods is cooked as the heat generated on the outside travels inward. Only the outer edge of food is cooked by microwave energy; the rest is cooked by conduction. The worst possible shape for a food that is to be microwaved is a thick square.

The corners will burn long before the center is even warm. Round thin foods and ring-shaped foods cook most successfully in the microwave.

Covering

A cover traps heat and steam which causes food to cook more quickly. Use a lid or microwave cling film with a corner folded back to prevent splitting.

Covering with Parchment Paper

Parchment paper (not waxed paper) is microwave safe. Because it makes a looser cover than a lid or clingfilm, greaseproof paper allows the food to dry out slightly.

Stirring

Stirring is one of the most important of all microwaving techniques. In conventional cooking, food is stirred for the purpose of blending. Microwaved food, however, is stirred in order to spread and redistribute heat. Always stir from the outside towards the centre as the outside of the food heats first.

Placing Thicker Portions Facing Outward

Place thicker cuts or portions of meat, poultry, and fish toward the outer edge of the baking dish so they absorb the most microwave energy and the food cooks more evenly.

Shielding

Strips of aluminium foil (which block microwaves) can be placed over the corners or edges of square and rectangular foods to prevent those portions from overcooking. Never use too much foil and make sure the foil is secured to the dish or it may cause arcing in the oven, especially if the foil passes too closely to the walls of the oven during rotation.

Elevating

Thick or dense foods can be elevated so that microwaves can be absorbed by the underside and center of the foods.

Piercing

Foods enclosed in a shell, skin or membrane are likely to burst in the oven unless they are pierced prior to cooking. Such foods include yolks and whites of eggs, clams, oysters, potatoes, and other whole vegetables and fruits.

Testing if Cooked

Microwaves cook food quickly, so test food for doneness frequently. Some foods are left in the microwave until completely cooked, but most foods, including meats and poultry, should be removed from the oven while still slightly undercooked and allowed to finish cooking during standing time. The internal temperature of foods will rise between 5 °F (3 °C) and 15 °F (8 °C) during standing time.

Microwave Power Levels

This upper oven is equipped with 10 power levels to give you maximum flexibility and control over cooking. See the table for suggested power levels for various foods.

Microwave Power Levels Chart

Power Level	Use
P-HI (100 %)	<ul style="list-style-type: none"> • Boiling water. • Browning ground beef. • Making candy. • Cooking poultry pieces, fish, & vegetables. • Cooking tender cuts of meat.
P-90	<ul style="list-style-type: none"> • Reheating rice, pasta, & vegetables.
P-80	<ul style="list-style-type: none"> • Reheating prepared foods quickly. • Reheating sandwiches.
P-70	<ul style="list-style-type: none"> • Cooking egg, milk and cheese dishes. • Melting chocolate.
P-60	<ul style="list-style-type: none"> • Cooking veal. • Cooking whole fish. • Cooking puddings and custard.
P-50	<ul style="list-style-type: none"> • Cooking ham, whole poultry and lamb. • Cooking rib roast and sirloin tip.
P-40	<ul style="list-style-type: none"> • Thawing meat, poultry and seafood.
P-30	<ul style="list-style-type: none"> • Cooking less tender cuts of meat. • Cooking pork chops and roasts.
P-20	<ul style="list-style-type: none"> • Taking chill out of fruit. • Softening butter.
P-10	<ul style="list-style-type: none"> • Keeping casseroles and main dishes warm. • Softening butter and cream cheese.

Cooking at High Power Level

Example: To cook food for 8 minutes 30 seconds.

- 1 Touch **Microwave**.
- 2 Set the cook time: Touch **8**, **3** and **0**.
- 3 Touch **Start** to start cooking.
 - When the cook time is over a melody sounds and **END OF CYCLE** displays.

Cooking at Lower Power Levels

HIGH power cooking does not always give the best results with foods that need slower cooking, such as roasts, baked goods, or custards. The oven has 9 power settings in addition to HIGH.

Example: To cook food for 7 minutes 30 seconds at 70% power.

- 1 Touch **Microwave**.
- 2 Set the cook time: Touch **7**, **3** and **0**.
- 3 Set the power level: Touch **Power Level** and **7**.
- 4 Touch **Start** to start cooking.
 - When the cook time is over a melody sounds and **END OF CYCLE** displays.

+30 seconds

Use this to quickly add 30 seconds to microwave cooking time.

- 1 Press the button when the oven is off to immediately start the microwave function for 30 seconds at High power.
- 2 Press **Upper Clear/Off** to pause the oven. Press it again to cancel cooking.

Defrost

The oven has 4 preset defrost cycles. The defrost feature provides the best defrosting method for frozen foods. The Defrost Table shows the suggested defrost cycle for various foods.

The Defrost function conveniently chimes partway through the defrost cycle to remind you to check, turn over, separate, or rearrange the food for best results.

- 1 **Meat**
- 2 **Poultry**
- 3 **Fish**
- 4 **Bread**

Setting the Defrost Function

Example: To defrost 1.2 pounds of meat.

- 1 Touch **Defrost**.
- 2 Touch **1** to select MEAT.
- 3 Set the weight : Touch **1**, **2**. (for 1.2 lbs)
- 4 Touch **Start** to start cooking.
- 5 When cooking is complete, touch **Clear/Off**.

NOTE

- The countdown appears in the display after **START** is pressed. The oven chimes once, partway through the defrost cycle.
- At the chime, open the oven door and turn the food over. Remove any food that has thawed. Return the still frozen items to the oven and touch **Start** to complete the defrost cycle.

Weight Conversion Table

Most food weights are given in pounds and ounces. If using pounds, food weights must be entered into Auto Defrost in pounds and tenths of pounds (decimals).

Use the following table if necessary to convert food weights to decimals.

Equivalent Weight	
OUNCES	DECIMAL WEIGHT
1.6	.10
3.2	.20
4.8	.30
6.4	.40
8.0	.50 One-Half Pound
9.6	.60
11.2	.70
12.8	.80
14.4	.90
16.0	1.00 One Pound

Defrost Table

Category	Food to be Defrosted
<p>Meat (dEF1) 0.1 - 6.0 lbs</p>	<p>Beef Ground beef, round steak, stew cubes, tenderloin steak, pot roast, rib roast, rump roast, chuck roast, hamburger patties</p> <p>Lamb Chops, rolled roast</p> <p>Pork Chops, hotdogs, spareribs, country-style ribs, rolled roast, sausage</p> <p>Veal Cutlets (1 lb, ½ inch thick)</p> <p>When BEEP, turn food over. After defrosting, let stand for 5 - 15 minutes.</p>
<p>Poultry (dEF2) 0.1 - 6.0 lbs</p>	<p>Poultry Whole, cut-up, breast (boneless). Rinse chicken cavity with tap water and let stand for 60 minutes after cooking for better results.</p> <p>Cornish Hens Whole</p> <p>Turkey Breast</p> <p>When BEEP, turn food over. After defrosting, let stand for 60 minutes.</p>
<p>Fish (dEF3) 0.1 - 4.0 lbs</p>	<p>Fish Fillets, whole steaks</p> <p>Shellfish Crab meat, lobster tails, shrimp, scallops</p> <p>When BEEP, turn food over. After defrosting, let stand for 5 - 10 minutes.</p>
<p>Bread (dEF4) 0.1 - 2.0 lbs</p>	<p>Sliced bread, buns, baguettes, etc. Separate slices and place between paper towels or on flat plate.</p> <p>When BEEP, turn food over. After defrosting, let stand for 1 - 2 minutes.</p>

Defrosting Tips

- When using Defrost, the weight to be entered is the net weight in pounds and tenths of pounds (the weight of the food minus the container).
- Before starting, remove the metal twist-ties which often come with frozen food bags, and replace them with strings or elastic bands.
- Open containers such as cartons before they are placed in the oven.
- Remove fish, shellfish, meat, and poultry from its original wrapping paper or plastic package. Otherwise, the wrap will hold steam and juice close to the foods, which can cause the outer surface of the foods to cook.
- If food is foil wrapped, remove foil and place the food in a suitable container.
- Slit the skins, if any, of frozen food such as sausage.
- Bend plastic pouches of food to ensure even defrosting.
- Place foods in a shallow container or in a microwave roasting dish to catch the drippings.
- Always underestimate defrosting time. Food should still be somewhat icy in the center when removed from the oven. If defrosted food is still icy in the center, return it to the upper oven for more defrosting.
- The length of defrosting time varies according to how solidly the food is frozen.
- Depending on the shape of the food, some areas may defrost more quickly than others.
- The shape of the package affects how quickly food will defrost. Shallow packages will defrost more quickly than a deep block.
- As food begins to defrost, separate the pieces to defrost them more easily.
- Turn over food during defrosting or standing time. Break apart and remove food as required.
- For best results, shape ground meat into the form of a doughnut before freezing. When defrosting, scrape off thawed meat when the beep sounds and continue defrosting.
- Use small pieces of aluminum foil to shield parts of food such as chicken wings, leg tips, fish tails, or areas that start to get warm. Make sure the foil does not touch the sides, top, or bottom of the oven. The foil can damage the oven lining.
- For better results, let food stand after defrosting.

Sensor Operation

Sensor Cook reheats favorite foods without selecting cooking times and power levels.

The oven automatically determines required cooking time for each food item. When the internal sensor detects a certain amount of humidity coming from the food, it tells the oven how much longer to heat. The display shows the remaining heating time. For best results when sensor cooking, follow these recommendations.

- Food cooked with the sensor system should be at normal storage temperature.
- The glass tray and the outside of the container should be dry to assure best cooking results.
- Foods should always be covered loosely with microwavable plastic wrap, waxed paper, or a lid.
- Do not open the door or touch Clear/Off during the sensing time. When sensing time is over, the oven beeps and the remaining cooking time will appear in the display window. At this time you can open the door to stir, turn, or rearrange the food.

Appropriate containers and coverings help assure good sensor cooking results.

- Always use microwavable containers and cover them with lids or vented plastic wrap.
- Never use tight-sealing plastic covers. They can prevent steam from escaping and cause food to overcook.
- Match the amount to the size of the container. Fill containers at least half full for best results.
- Be sure the outside of the cooking container and the inside of the upper oven are dry before placing food in the oven. Beads of moisture turning into steam can mislead the sensor.

Using Sensor Cook

Use Sensor Cook to heat common microwave-prepared foods without needing to program times and power levels. Sensor Cook has preset programs for 9 food categories. See the Sensor Cook table for more information.

Setting the Sensor Cook Function

Example: To sensor cook rice

- 1 Touch **Sensor Cook**.
- 2 Touch **7** to select RICE.
- 3 Touch **Start**.
 - When the cook time is over a melody sounds and **END OF CYCLE** displays.

Sensor Cook Table

- The Sensor Cook function has preprogrammed settings to automatically sensor reheat certain foods.

Category	Weight	Cookware	Food Temp.	Instructions
1. Beverage	1-2 cups (240 ml per cup)	Mug or microwave-safe cup on the glass tray	Room	Use microwave safe mug or cup without covering. After cooking, stir to complete reheating. (Be careful! The beverage will be very hot. Sometimes liquids heated in cylindrical containers will splash out unexpectedly when the cup is moved.)
2. Casserole	10-20 oz	Microwave-safe bowl on the glass tray	Refrigerated	Use microwave safe bowl. Cover container with vented plastic wrap. After cooking, let stand for 3 minutes.
3. Chicken	16-20 oz	Microwave-safe bowl on the glass tray	Refrigerated	Use microwave safe bowl. Cover container with vented plastic wrap. After cooking, let stand for 3 minutes.
4. Pasta	½-2 cups	Microwave-safe bowl on the glass tray	Refrigerated	Use microwave safe bowl. Cover container with vented plastic wrap. After cooking, let stand for 3 minutes.
5. Pizza	1-3 slices	Microwave-safe plate on the glass tray	Refrigerated	This is a reheat function for leftover pizza. Use microwave safe plate without covering.
6. Plate of food	1 serving	Microwave-safe plate on the glass tray	Refrigerated	Use microwave safe plate. Cover container with vented plastic wrap. After cooking, let stand for 3 minutes.
7. Rice	½-2 cups	Microwave-safe bowl on the glass tray	Refrigerated	Use microwave safe bowl. Cover container with vented plastic wrap. After cooking, let stand for 3 minutes.
8. Soup	1-4 cups	Microwave-safe bowl on the glass tray	Room	Use microwave safe bowl. Cover container with vented plastic wrap. After cooking, let stand for 3 minutes.
9. Vegetable	1-4 cups	Microwave-safe bowl on the glass tray	Refrigerated	Use microwave safe bowl. Cover container with vented plastic wrap. After cooking, let stand for 3 minutes.

Convection Bake

During Convection Bake, a heating element is used to raise the temperature of the air inside the oven. Convection cooking temperature ranges from 100 °F to 450 °F.

It is best to preheat the oven when convection cooking.

NOTE

Reduce oven temperature by 25 °F from the temperature recommended on packaged foods. The baking time may vary according to the food condition or individual preference.

Setting the Convection Bake Function

Example: 45 minutes at 375°F with preheating

- 1 Touch **Conv.Bake**. The display flashes 350 °F.
- 2 Set the oven temperature: touch **3, 7** and **5**.
- 3 Touch **Start**. The oven starts to preheat and display shows **Conv.Bake** and the oven temperature. (Do not enter the time.)
- 4 When the melody sounds, Place the food in the oven.
- 5 Set the cook time: touch **4, 5**.
- 6 Touch **Start**.
- 7 When cooking is complete, touch **Clear/Off**.

Example: 30 minutes at 375°F without preheating

- 1 Touch **Conv. Bake**. The display flashes 350 °F.
- 2 Set the oven temperature: touch **3, 7** and **5**.
- 3 Touch **Cook Time**.
- 4 Set the cook time: touch **3, 0**.
- 5 Touch **Start**.
- 6 When cooking is complete, touch **Clear/Off**.

NOTE

- When the oven reaches the set preheat temperature, a melody will sound and the display scrolls the message PREHEAT END. The oven automatically holds that temperature for 30 minutes.
- The oven temperature drops very quickly when the door is opened; however, this should not prevent food from being fully cooked during normal cooking time.

Broil

This feature will allow you to brown and crisp food quickly. There is no need for preheating.

Setting the Broil Function

Example: Broiling for 1 minute 30 seconds

- 1 Touch **Broil**.
- 2 Set the cook time: touch **1, 3** and **0**.
- 3 Touch **Start**. The oven begins to heat.
- 4 Touch **Clear/Off** to cancel at any time or when cooking is complete.



CAUTION

Always use oven gloves when removing the food and accessories after cooking as the oven & accessories will be very hot.

NOTE

For best results, use the rack when broiling in the upper oven.

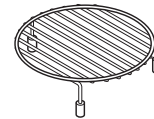

Rack

Speed Cook

This feature uses power from a halogen light, heaters, and microwaves simultaneously to allow quick cooking.

NOTE

Power levels only can be selected from 10 to 40 %. Each power level gives you heater power and microwave energy for a certain percentage of the time.



CAUTION

When using Speed Cook function, remember that the oven, door and dishes will be very hot.

Setting the Speed Convection Function

Use this mode for roast meat, roast chicken, roast vegetables, frozen pizza, cake, pies and breads.

Example: Cooking for 1 minute 30 seconds at 40 % power and 375 °F

- 1 Touch **Speed Cook**.
- 2 Touch **1** to select SPEED CONVECTION.
- 3 Set the power level: touch **4**.
- 4 Set the oven temperature: touch **3, 7, 5** and **Start**.
- 5 Set the cook time : touch **1, 3** and **0**.
- 6 Touch **Start**. The oven begins to heat.
- 7 When cooking has finished or to cancel, touch **Clear/Off**.

Setting the Speed Broil Function

Use this mode for steaks, chicken fillets, fish or seafood.

Example: Cooking for 1 minute 30 seconds at 20 % power

- 1 Touch **Speed Cook**.
- 2 Touch **2** to select SPEED BROIL.
- 3 Set the power level: touch **2**.
- 4 Set the cook time : touch **1, 3** and **0**.
- 5 Touch **Start**. The oven begins to heat.
- 6 When cooking has finished or to cancel, touch **Clear/Off**.

Auto Cook

Use Auto Cook to heat common prepared foods without selecting cooking times and power levels. Auto Cook has preset programs for 28 food functions.

Setting the Auto Cook Function

Example: To auto cook 4 slices of bacon

- 1 Touch **More Mode**.
- 2 Touch **1** to select AUTO COOK.
- 3 Select the food item: touch **1** for BACON.
- 4 Touch **Start** to enter choice.
- 5 Set the weight or amount: touch **1** to select 3-4 slices of bacon.
- 6 Touch **Start** to begin cooking.

Auto Cook Table

Category	Weight	Cookware	Food Temp.	Instructions
1. Bacon (regular sliced)	3-4 5-6 slices	Microwave-safe bacon rack or plate on the glass tray.	Refrigerated	Place bacon slices on a microwave rack for best results. Use a plate lined with paper towels if rack is not available. Press 1 for 3-4 slices. Press 2 for 5-6 slices.
2. Bagels (frozen)	1, 2-3 bagels	Metal tray	Frozen	Press 1 or 2 according to how many bagels need defrosting.
3. Baked potatoes (7-9 oz/ea)	1, 2, 3-4 potatoes	Metal tray	Room	Pierce each potato several times with a fork. Press 1 for 1 potato, 2 for 2 potatoes, and 3 for 3-4 potatoes.
4. Brownie	8" X 8" 9" X 13"	Microwave-safe bowl on the glass tray	Room	Spray microwave-safe glass or silicone bakeware with cooking spray. Pour batter into bakeware, spreading it evenly. Press 1 for an 8"x8" pan. Press 2 for a 9"x13" pan. After cooking, Allow to rest for a few minutes.
5. Cod fillets (1 lb)	-	Metal tray	Refrigerated	Brush with oil and season with salt and pepper. Turn food over at the beep.
6. Corn dog (frozen)	1-2, 3-4	Metal tray	Frozen	Press 1 for 1-2 corn dogs. Press 2 for 3-4 corn dogs.
7. Fresh vegetable	4-6, 7-9, 10-12, 13-15, 16-20 oz	Microwave-safe bowl on the glass tray	Refrigerated	Add water according to the quantity. <ul style="list-style-type: none"> • 4-12 oz : add 2 tbsp water • 13-20 oz : add 4 tbsp water Cover with vented plastic wrap. After cooking, stir and let stand for 3 minutes.
8. Frozen chicken nuggets	1-2, 3-4 servings (3.5 oz/100 g per serving)	Metal tray	Frozen	Press 1 for 1-2 servings. Press 2 for 3-4 servings. Turn food over at the beep.
9. Frozen chicken wings	1-2, 3-4 servings (3.5 oz/100 g per serving)	Metal tray	Frozen	Press 1 for 1-2 servings. Press 2 for 3-4 servings. Turn food over at the beep.
10. Frozen fries	1-2, 3-4 servings (3.5 oz/100 g per serving)	Metal tray	Frozen	Press 1 for 1-2 servings. Press 2 for 3-4 servings. Turn food over at the beep.
11. Frozen pizza (regular crust)	Individual (6") Regular (12")	Metal tray	Frozen	Press 1 for 6" pizza. Press 2 for 12" pizza.
12. Frozen soft pretzels	1, 2, 3-4 pretzels	Metal tray	Frozen	Press 1 for 1 pretzel, 2 for 2 pretzels, or 3 for 3-4 pretzels.
13. Frozen vegetable	4-6, 7-9, 10-12, 13-15, 16-20 oz	Microwave-safe bowl on the glass tray	Frozen	Add water according to the quantity. <ul style="list-style-type: none"> • 4-12 oz : add 2 tbsp water • 13-20 oz : add 4 tbsp water Cover with vented plastic wrap. After cooking, stir and let stand for 3 minutes.
14. Garlic bread (sliced, frozen)	1-2, 3-4, 5-6 pieces	Metal tray	Frozen	Press 1 for 1-2 pieces, 2 for 3-4 pieces, or 3 for 5-6 pieces. Turn food over at the beep.

Category	Weight	Cookware	Food Temp.	Instructions												
15. Hamburger (1/2" thick)	2, 3-4, 5-6 patties	Metal tray	Refrigerated	Press 1 for 2 burgers, 2 for 3-4 burgers, or 3 for 5-6 burgers. Turn food over at the beep.												
16. Lamb chops (1/2" thick, 6-7 oz)	1, 2, 3-4 chops	Metal tray	Refrigerated	Brush with oil and season with salt and pepper. Press 1 for 1 chop, 2 for 2 chops, or 3 for 3-4 chops. Turn food over at the beep.												
17. Meat loaf (9" X 5")	-	Microwave-safe glass or silicone bakeware on the glass tray	Refrigerated	<p>Ingredients</p> <table border="1"> <tr> <td>Ground meat</td> <td>800 g</td> </tr> <tr> <td>Egg (refrigerating temp.)</td> <td>115 g</td> </tr> <tr> <td>Salt</td> <td>2 g</td> </tr> </table> <p>Cooking Place meat mixture into microwave-safe 9"x5" glass or silicone bakeware.</p>	Ground meat	800 g	Egg (refrigerating temp.)	115 g	Salt	2 g						
Ground meat	800 g															
Egg (refrigerating temp.)	115 g															
Salt	2 g															
18. Nachos	1-3, 4-6 servings (8 ea / 1 serving)	Metal tray	Room	Press 1 for 1-3 servings. Press 2 for 4-6 servings.												
19. Oatmeal	1, 2 servings	Large microwave-safe bowl on the glass tray	Room	<p>Ingredients</p> <table border="1"> <tr> <td></td> <td>1 serving</td> <td>2 servings</td> </tr> <tr> <td>Oats</td> <td>½ cup (40 g)</td> <td>1 cup(80 g)</td> </tr> <tr> <td>Water or Milk</td> <td>1 cup (230 g)</td> <td>1 ½ cups (345 g)</td> </tr> <tr> <td>Salt (Optional)</td> <td>Dash</td> <td>1/8 tsp</td> </tr> </table> <p>Cooking Combine water or milk, salt and oats in a large microwave-safe bowl. Cover with vented plastic wrap. Press 1 for 1 serving. Press 2 for 2 servings. After cooking, let stand for 3 minutes.</p>		1 serving	2 servings	Oats	½ cup (40 g)	1 cup(80 g)	Water or Milk	1 cup (230 g)	1 ½ cups (345 g)	Salt (Optional)	Dash	1/8 tsp
	1 serving	2 servings														
Oats	½ cup (40 g)	1 cup(80 g)														
Water or Milk	1 cup (230 g)	1 ½ cups (345 g)														
Salt (Optional)	Dash	1/8 tsp														
20. Pork chops (1/2" thick, 6-7 oz)	1, 2, 3-4 chops	Metal tray	Refrigerated	Brush with oil and season with salt and pepper. Press 1 for 1 chop, 2 for 2 chops, or 3 for 3-4 chops. Turn food over at the beep.												
21. Quinoa	1, 2 servings	Large microwave-safe bowl on the glass tray	Room	<p>Ingredients</p> <table border="1"> <tr> <td></td> <td>1 serving</td> <td>2 servings</td> </tr> <tr> <td>Quinoa</td> <td>½ cup (40 g)</td> <td>1 cup (80 g)</td> </tr> <tr> <td>Water or Milk</td> <td>1 cup (230 g)</td> <td>1 ½ cups (345 g)</td> </tr> <tr> <td>Salt (Optional)</td> <td>Dash</td> <td>1/8 tsp</td> </tr> </table> <p>Cooking Combine water or milk, salt and quinoa in a large microwave-safe bowl. Cover with vented plastic wrap. Press 1 for 1 serving. Press 2 for 2 servings. After cooking, let stand for 3 minutes.</p>		1 serving	2 servings	Quinoa	½ cup (40 g)	1 cup (80 g)	Water or Milk	1 cup (230 g)	1 ½ cups (345 g)	Salt (Optional)	Dash	1/8 tsp
	1 serving	2 servings														
Quinoa	½ cup (40 g)	1 cup (80 g)														
Water or Milk	1 cup (230 g)	1 ½ cups (345 g)														
Salt (Optional)	Dash	1/8 tsp														
22. Ribeye steak (1" thick, 14-15 oz)	1, 2 steaks	Metal tray	Refrigerated	Brush with oil and season with salt and pepper. Press 1 for 1 steak or 2 for 2 steaks. Turn food over at the beep.												

Category	Weight	Cookware	Food Temp.	Instructions		
23. Rice	½, 1 cup	Deep and large microwave-safe bowl on the glass tray	Room	Ingredients		
					½ cup	1 cup
				Rice	½ cup (96 g)	1 cup (192 g)
				Water	1 cup (230 g)	2 cups (460 g)
				Salt	Optional	
				Cooking Cover with vented plastic wrap. Press 1 for ½ cup of dried rice or 2 for 1 cup of dried rice. After cooking, let stand for 5-10 minutes.		
24. Salmon steak (1" thick)	1, 2, 3-4 steaks	Metal tray	Refrigerated	Brush with oil and season with salt and pepper. Press 1 for 1 steak, 2 for 2 steaks, or 3 for 3-4 steaks. Turn food over at the beep.		
25. Sausage	1-6, 7-14 links	Metal tray	Refrigerated	Press 1 for 1-6 links. Press 2 for 7-14 links. Turn food over at the beep.		
26. Sirloin steak (1" thick, 18-21 oz)	1, 2 steaks	Metal tray	Refrigerated	Brush with oil and season with salt and pepper. Press 1 for 1 steak, 2 for 2 steaks. Turn food over at the beep.		
27. Tenderloin	¾, 1 ½ lb	Metal tray	Refrigerated	Brush with oil and season with salt and pepper. Press 1 for ¾ lb, 2 for 1 ½ lb. Turn food over at the beep.		
28. Vegetable-canned	4-6, 7-9, 10-12, 13-15, 16-20 oz	Microwave-safe bowl on the glass tray	Room	Transfer canned vegetables to microwave-safe bowl. Cover with vented plastic wrap. Press 1 for 4-6 oz, 2 for 7-9 oz, 3 for 10-12 oz, 4 for 13-15 oz, or 5 for 16-20 oz. After cooking, stir and let stand for 3 minutes.		

NOTE

- Do not use recycled paper products in the upper oven. They sometimes contain impurities that cause arcing and sparking.
- **NEVER** use paper products in the convection oven.

Soften

The oven uses low power to soften foods such as butter, cream cheese, frosting, and ice cream. See the following table.

Setting the Soften Function

Example, 1 pint of ice cream

- 1 Touch **More Mode**.
- 2 Touch **2** to select SOFTEN.
- 3 Set the Menu: touch **4** to select ICE CREAM and touch **Start**.
- 4 Set the amount: touch **1** to select 1 pint.
- 5 Touch **Start**.
 - When the cook time is over a melody sounds and **END OF CYCLE** displays.

Soften Table

Category	Weight	Cookware	Food Temp.	Instructions
1. Butter	½, 1, 2 sticks	Microwave-safe dish on the glass tray	Refrigerated	Press 1 for ½ stick, 2 for 1 stick, or 3 for 2 sticks. Butter will be at room temperature and ready for use in a recipe.
2. Cream cheese	3, 8 oz	Microwave-safe dish on the glass tray	Refrigerated	Press 1 for 3 oz. or 2 for 8 oz. Cream cheese will be at room temperature and ready for use in a recipe.
3. Frosting (16 oz)	-	Microwave-safe bowl on the glass tray	Refrigerated	Frosting will be at room temperature and ready for use in a recipe.
4. Ice cream	1 pint, 1 quart	Glass tray	Frozen	Remove lid and cover. Press 1 for 1 pint or 2 for 1 quart. Ice cream will be soft enough to make scooping easier.

Melt

The oven uses low power to melt foods such as butter, caramel, cheese, chocolate, and marshmallows.

See the following table.

Setting the Melt Function

Example, 8 oz of chocolate.

- 1 Touch **More Mode**.
- 2 Touch **4** to select MELT.
- 3 Set the Menu: touch **4** to select CHOCOLATE and touch **Start**.
- 4 Set the amount: touch **2** to select 8 oz.
- 5 Touch **Start**.
 - When the cook time is over a melody sounds and **END OF CYCLE** displays.

Melt Table

Category	Weight	Cookware	Food Temp.	Instructions
1. Butter	½, 1, 2 sticks	Microwave-safe bowl on the glass tray	Refrigerated	Press 1 for ½ stick, 2 for 1 stick, or 3 for 2 sticks. After cooking, stir to complete melting.
2. Caramel	4, 8, 12 oz	Microwave-safe bowl on the glass tray	Room	Press 1 for 4 oz., 2 for 8 oz., or 3 for 12 oz. After cooking, stir to complete melting.
3. Cheese	4, 8, 12 oz	Microwave-safe bowl on the glass tray	Refrigerated	Use processed cheese food only. Cut into cubes. Press 1 for 4 oz., 2 for 8 oz., or 3 for 12 oz. After cooking, stir to complete melting.
4. Chocolate	4, 8, 12 oz	Microwave-safe bowl on the glass tray	Room	Chocolate chips or squares of baking chocolate may be used. Press 1 for 4 oz., 2 for 8 oz., or 3 for 12 oz. After cooking, stir to complete melting.
5. Marshmallow	5, 10 oz	Microwave-safe bowl on the glass tray	Room	Press 1 for 5 oz. or 2 for 10 oz. After cooking, stir to complete melting.

Warm

The WARM function maintains an oven temperature of less than 230°F. This function should not be used to reheat cold food. The Warm function keeps cooked food warm for serving up to 3 hours after cooking has finished. After 3 hours the WARM function shuts the oven OFF automatically.

Setting the Warm Function

- 1 Touch **More Mode**.
- 2 Touch **4** to select WARM.
- 3 Select the temperature level: touch **1** for low, **2** for medium, or **3** for high.
- 4 Touch **Start**.
- 5 Select the type: touch **1** for moist, **2** for crisp.
- 6 Touch **Start** to start warming.
- 7 Touch **Clear/Off** at any time to cancel.

NOTE

- Low = 140°-160°F (60°-71°C)
Medium = 160°-195°F (71°-91°C)
High = 195°-230°F (91°-110°C)
- The Warm function is intended to keep food warm. Do not use it to cool food down.
- It is normal for the fan to operate during the Warm function.

Proof

This feature maintains a warm oven for rising yeast leavened products before baking.

Setting the Proof Function

- 1 Touch **More Mode**.
- 2 Touch **5** to select PROOF.
- 3 Touch **Start** to start proofing.
- 4 Touch **Clear/Off** at any time to cancel.

NOTE

- To avoid lowering the oven temperature and lengthening proofing time, do not open the oven door unnecessarily.
- Check bread products early to avoid over-proofing.
- Do not use the proofing mode for warming food or keeping food hot. The proofing oven temperature is not hot enough to hold foods at safe temperatures. Use the WARM feature to keep food warm.
- Proofing will not operate if the oven is too hot. Allow the oven to cool before proofing.

Popcorn

Setting the Popcorn Function

- 1 Touch **Popcorn**.
- 2 Touch **Start**.
The Popcorn function starts.
- 3 Touch **Clear/Off** to cancel Popcorn at any time.

NOTE

- Only pop popcorn in a microwave-safe container or commercial packages designed for microwave ovens.
- Never try to pop popcorn in a paper bag that is not microwave-approved.
- If popcorn bag size is not known, follow manufacturers' instructions and do not use this feature.
- Prepare only one bag at a time.
- Do not use popcorn popping devices in upper oven with this feature.
- Do not leave oven unattended while popping corn.
- Do not use POPCORN key pad in combination with any other feature key pads.
- Do not attempt to reheat or cook any unpopped kernels.
- Do not reuse bag. Overcooking can result in an oven fire.



CAUTION

Never use a brown paper bag for popping corn.



When popping prepackaged popcorn, place the bag carefully in the oven so it does not touch the walls as it rotates. Fold the ends of the bag up and toward the center of the bag as shown.

Using the Lower Oven

Before Using the Lower Oven

NOTE

- Because the oven temperature cycles, an oven thermometer placed in the oven cavity may not show the same temperature that is set on the oven.
- It is normal for the convection fan to run while preheating during a regular bake cycle.
- The convection fan motor may run periodically during a regular bake cycle.
- The heat turns off if the door is left open during baking. If the door is left open for longer than 30 seconds during baking, the heat turns off. The heat turns back on automatically once the door is closed.

Lower Oven Light

The interior oven light automatically turns on when the door is opened. Touch **Lower Light** to manually turn the lower oven light on. The lamp of the lower oven will turn off after 2 minutes and 30 seconds to save power.

NOTE

The oven light cannot be turned on if the Self Clean function is active.

Minimum & Maximum Default Settings

All of the features listed have a minimum and a maximum time or temperature setting that may be entered into the control. An entry acceptance beep sounds each time a control key is touched.

An entry error tone (two short tones) sounds if the entry of the temperature or time is below the minimum or above the maximum setting for the feature.

Feature	Min. Temp. / Time	Max Temp. / Time	Default	
Clock	12 Hr.	1:00 Hr. / min.	12:59 Hr. / min.	
	24 Hr.	0:00 Hr. / min.	23:59 Hr. / min.	
Timer	12 Hr.	0:01 min.	11:59 Hr. / min.	
	24 Hr.	0:01 min.	11:59 Hr. / min.	
Cook Time	12 Hr.	0:01 min.	11:59 Hr. / min.	
	24 Hr.	0:01 min.	11:59 Hr. / min.	
Conv. Bake	300 °F / 150 °C	550 °F / 285 °C	350 °F (*325 °F) / 12 Hr.	
Conv. Roast	300 °F / 150 °C	550 °F / 285 °C	350 °F (*325 °F) / 12 Hr.	
Broil	Lo 400 °F	Hi 500 °F	Hi / 3 Hr.	
Bake	170 °F / 80 °C	550 °F / 285 °C	350 °F / 12 Hr.	
Proof			12 Hr.	
Warm			3 Hr.	
Self Clean	3 Hr.	5 Hr.	4 Hr.	
EasyClean®			10 min.	

* Using Auto Conversion

- Default cook mode times are without setting cook time.

Using Oven Racks

The racks have a turned-up back edge that prevents them from being pulled out of the oven cavity.

Removing Racks

- 1 Pull the rack straight out until it stops.
- 2 Lift up the front of the rack and pull it out.

Replacing Racks

- 1 Place the end of the rack on the support.
- 2 Tilt the front end up and push the rack in.

CAUTION

- Replace oven racks before turning the oven on to prevent burns.
- Do not cover the racks with aluminum foil, or any other material, or place anything on the bottom of the oven. Doing so will result in poor baking and may damage the oven bottom.
- Only arrange oven racks when the oven is cool.

Bake

Bake is used to prepare foods such as pastries, breads and casseroles. The oven can be programmed to bake at any temperature from 170 °F (80 °C) to 550 °F (285 °C). The default temperature is 350 °F (175 °C).

Setting the Bake Function

Example: To bake at 375 °F

- 1 Touch **Bake**.
- 2 Set the oven temperature: touch **3**, **7** and **5**.
- 3 Touch **Start**. The oven starts to preheat.

As the oven preheats, the temperature is displayed and rises in 5-degree increments. Once the oven reaches the set temperature, a tone sounds and the oven light blinks on and off.

PREHEATING

Place the food in the oven after preheating. Preheating is necessary for better cooking results.

- 4 When cooking is complete, touch **Clear/Off**.
- 5 Remove food from the oven.

Changing Bake Temperature while Cooking

Example: changing from 375 °F to 425 °F

- 1 Touch **Bake**.
- 2 Set the oven temperature: touch **4**, **2** and **5**.
- 3 Touch **Start**.

NOTE

It is normal for the convection fan to operate periodically throughout a normal bake cycle in the lower oven. This is to ensure even baking results.

Baking Tips

- Baking time and temperature will vary depending on the characteristics, size, and shape of the baking pan used.
- Check for food doneness at the minimum recipe time.
- Use metal bakeware (with or without a nonstick finish), heatproof glass-ceramic, ceramic or other bakeware recommended for oven use.
- Dark metal pans or nonstick coatings will cook food faster with more browning. Insulated bakeware will slightly lengthen the cooking time for most foods.

NOTE

The oven bottom has a porcelain-enamel finish. To make cleaning easier, protect the oven bottom from excessive spillovers by placing a cookie sheet on the rack below the rack you are cooking on. This is particularly important when baking a fruit pie or other foods with a high acid content. Hot fruit fillings or other foods that are highly acidic may cause pitting and damage to the porcelain-enamel surface and should be wiped up immediately.

Multi-Rack Baking

- The oven has 5 rack positions.

Baking results will be better if baking pans are centered in the oven as much as possible. If baking with more than one pan, place the pans so each has at least 1" to 1½" of air space around it.

If cooking on multiple racks, place the oven racks in positions 2 and 4 (for two racks). Place the cookware as shown.

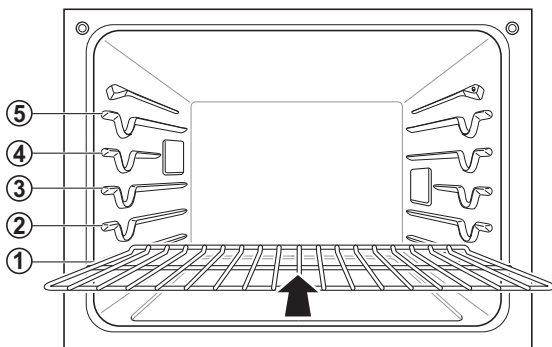

Multiple rack

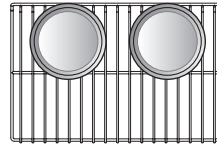

(Position 4)

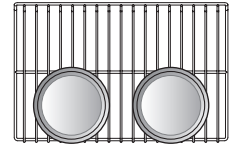

(Position 2)

Single rack

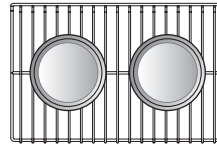

(Position 3)

NOTE

- Preheating is necessary for good results when baking cakes, cookies, pastries and breads. After the oven has reached the desired temperature, the preheat melody sounds once.
- The heating elements turn off immediately when the door is opened. They will turn on again approximately 5 seconds after the door is closed. If the oven door is left open for more than 30 minutes, all settings are canceled.
- Touch **Lower Clear/Off** to cancel Bake at any time.

Type of Food	Rack Position
Angel food cake, frozen pies	1
Bundt or pound cakes	2
Biscuits, muffins, brownies, cookies, cupcakes, layer cakes, pies	3
Casseroles	3
Turkey, roasts, or ham	1
Frozen pizza	3
Roast chicken	2

Oven Vent

- Areas near the vent may become hot during operation and may cause burns.
- **Do not** block the vent opening at the bottom of the oven.
- Avoid placing plastics near the vent as heat may distort or melt the plastic.
- It is normal for steam to be visible when cooking foods with high moisture.

Convection Mode

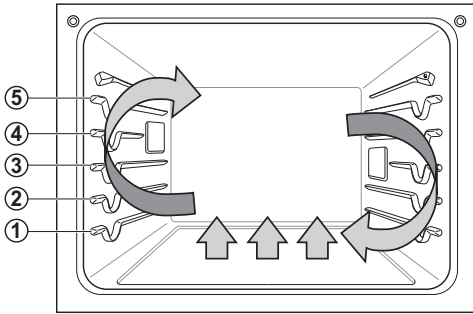

The convection system uses a fan to circulate the heat evenly within the oven. Improved heat distribution allows for even cooking and excellent results while cooking with single or multiple racks.

The lower oven uses convection auto conversion to automatically subtract 25°F/14°C from the temperature you enter. To disable convection auto conversion, see "Setting Convection Auto Conversion."

Setting the Convection Function

Example: To cook at 350°F (auto-converted)

- 1** Touch **Conv. Bake** or **Conv. Roast**. The display flashes 350 °F.
- 2** Set the oven temperature: touch **3**, **7** and **5**.
- 3** Touch **Start**. The display shows **Conv. Bake** or **Conv. Roast** and the oven temperature starting at 100 °F.

As the oven preheats, the display shows increasing temperatures in 5-degree increments. Once the oven reaches the set adjusted temperature, a tone sounds and the oven light flashes on and off. The display shows the auto converted oven temperature, 350 °F, and the fan icon.

- 4** When cooking has finished or to cancel, touch **Clear/Off**.

NOTE

The oven fan runs while convection baking. The fan stops when the door is open. In some cases, the fan may shut off during a convection bake cycle. It turns on again approximately 1 second after the door is closed. Touch **Lower Clear/Off** to cancel Convection Bake at any time.

Tips for Convection Baking

- Use Convection Bake for faster and more even multiple-rack cooking of pastries, cookies, muffins, biscuits, and breads of all kinds.
- Bake cookies and biscuits on pans with no sides or very low sides to allow heated air to circulate around the food. Food baked on pans with a dark finish will cook faster.
- When using Convection Bake with a single rack, place oven rack in position 3. If cooking on multiple racks, place the oven racks in positions 2 and 4 (for two racks).
- Multiple oven rack cooking may slightly increase cook times for some foods.
- Cakes, cookies and muffins have better results when using multiple racks.

The Convection Roast feature is designed to give optimum roasting performance. Convection Roast combines cooking with the convection fan to roast meats and poultry. The heated air circulates around the food from all sides, sealing in juices and flavors. Foods are crispy brown on the outside while staying moist on the inside. Convection roasting is especially good for large tender cuts of meat, uncovered.

Tips for Convection Roasting

Use a broiler pan and grid when preparing meats for convection roasting. The broiler pan catches grease spills and the grid helps prevent grease splatters.

- 1** Place the oven rack in position 1.
- 2** Place the grid in the broiler pan.
- 3** Place the broiler pan on the oven rack.

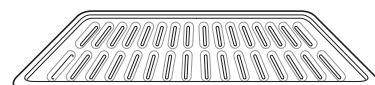

Grid

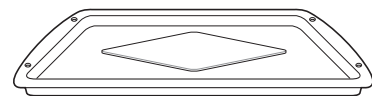

Broiler pan

CAUTION

- Do not use a broiler pan without a grid.
- Do not cover the grid with aluminum foil.
- Position food (fat side up) on the grid.

Broil

Broiling uses an intense, radiant heat to cook food. Both the inner and outer broil elements heat during full broiling. Only the inner broil element heats during center broiling. The element(s) cycle on and off at intervals to maintain the oven temperature. The meat probe cannot be used with this mode.



CAUTION

- Do not use a broiler pan without a grid. Oil can cause a grease fire.
- Do not cover the grid and broiler pan with aluminum foil. Doing so will cause a fire.
- Always use a broiler pan and grid for excess fat and grease drainage. This will help to reduce splatter, smoke, and flare-ups.

NOTE

This oven is designed for closed-door broiling. Close the door to set the Broil function. If the door is open, the Broil function cannot be set and **door** appears on the display. Close the door and reset the Broil function. Opening the door turns off the broil burner during broiling. If the door is opened during broiling, the broil burner turns off after five seconds. The broiler turns back on automatically once the door is closed.

Setting the Oven to Broil

- 1 Place the food on the broiler pan grid.
- 2 Touch **Broil**.
- 3 Touch **1** for full broiling or **2** for center broiling.
- 4 Touch **1** for High, **2** for Medium or **3** for Low broil.
- 5 Touch **Start**. The oven begins to broil.
- 6 Broil on one side until food is browned ; turn and cook on the other side.

NOTE

Always pull the rack out to the stop position before turning or removing food.

- 7 When broiling is finished, touch **Lower Clear/Off**. Touch **Clear/Off** to cancel this function at any time.

Smoking

Due to the intense heat associated with broiling, it is normal to experience smoke during the cooking process. This smoke is a natural byproduct of searing and should not cause you to worry. If you are experiencing more smoke than you are comfortable with, use the following tips to reduce the amount of smoke in your oven.

- 1 Always use a broiler pan. Do not use saute pans or regular baking sheets for safety reasons.
- 2 The broiler pan should always be thoroughly cleaned and at room temperature at the beginning of cooking.
- 3 Keep the interior of your oven as clean as possible. Leftover debris from prior meals can burn or catch fire.
- 4 Avoid fatty marinades and sugary glazes. Both of these will increase the amount of smoke you experience. If you would like to use a glaze, apply it at the very end of cooking.
- 5 If you are experiencing significant smoke with any food item, consider:
 - Lowering the broiler to the Lo setting.
 - Lowering the rack position to cook the food further away from the broiler.
 - Using the Hi broil setting to achieve the level of searing you desire, and then either switching to the Lo broil setting, or switching to the Bake function.
- 6 As a rule, fattier cuts of meat and fish will produce more smoke than leaner items.
- 7 Adhere to the recommended broil settings and cooking guidelines in the chart on the following page whenever possible.

Recommended Broiling Guide

The size, weight, thickness, starting temperature, and your preference of doneness will affect broiling times.

This guide is based on meats at refrigerator temperature. For best results when broiling, use a pan designed for broiling.

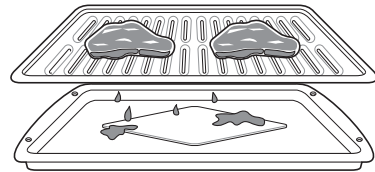

Food	Quantity and/ or Thickness	Shelf Position	First Side Time (min.)	Second Side Time (min.)	Comments
Ground Beef	1 lb. (4 patties) 1/2 to 3/4" thick	5	4-6	3-4	Space evenly. Up to 8 patties may be broiled at once.
Beef Steaks					Steaks less than 1" thick cook through before browning. Pan frying is recommended. Remove fat.
Rare	1" thick	4	6	2-3	
Medium	1 to 1 1/2 lbs.	4	7	2-3	
Well Done		4	8	3-4	
Rare	1 1/2" thick	4	10	4-6	
Medium	2 to 2 1/2 lbs.	4	12	6-8	
Well Done		4	14	8-10	
Chicken	1 whole cut up 2 to 2 1/2 lbs., split lengthwise	3	20	6-8	Broil skin-side-down first.
	2 Breasts	3	20	6-10	
Lobster Tails	2-4 10 to 12 oz. each	3	12-14	Do not turn over.	Cut through back of shell. Spread open. Brush with melted butter before broiling and after half of broiling time.
Fish Fillets	1/4 to 1/2" thick	4 or 5	5-6	3-4	Handle and turn very carefully. Brush with lemon butter before and during cooking, if desired.
Ham Slices (precooked)	1/2" thick	4	5	3-5	Increase time 5 to 10 minutes per side for 1 1/2" thick or home-cured ham.
Pork Chops	2 (1/2" thick)	4 or 5	7	6-8	Remove fat.
Well Done	2 (1" thick) about 1 lb.	4 or 5	9-10	7-9	
Lamb Chops					Remove fat.
Medium	2 (1" thick) about 10 to 12 oz.	4	6	4-6	
Well Done		4	8	7-9	
Medium	2 (1 1/2" thick)	4	11	9	
Well Done	about 1 lb.	4	13	9-11	
Salmon Steaks	2 (1" thick)	4 or 5	8	3-4	Grease pan. Brush steaks with melted butter.
	4 (1" thick) about 1 lb.	4 or 5	9	4-6	

- This guide is only for reference. Adjust cook time according to your preference.

NOTE

The USDA advises that consuming raw or undercooked fish, meat, or poultry can increase your risk of food-borne illness.

The USDA has indicated the following as safe minimum internal temperatures for consumption:

- Ground beef: 160 °F (71.1 °C)
- Poultry: 165 °F (73.9 °C)
- Beef, veal, pork, or lamb: 145 °F (62.8 °C)
- Fish / Seafood: 145 °F (62.8 °C)

Tips for Broiling

Beef

- Steaks and chops should always be allowed to rest for five minutes before being cut into and eaten. This allows the heat to distribute evenly through the food and creates a more tender and juicy result.
- Pieces of meat that are thicker than two inches should be removed from the refrigerator 30 minutes prior to cooking. This will help them cook more quickly and evenly, and will produce less smoke when broiling. Cooking times will likely be shorter than the times indicated in the Broiling Chart.
- For bone-in steaks or chops that have been *frenched* (all meat removed from around the bone), wrap the exposed sections of bone in foil to reduce burning.

Seafood

- When broiling skin-on fish, always use the Lo broil setting and always broil the skin side last.
- Seafood is best consumed immediately after cooking. Allowing seafood to rest after cooking can cause the food to dry out.
- It is a good idea to rub a thin coating of oil on the surface of the broiling pan before cooking to reduce sticking, especially with fish and seafood. You can also use a light coating of non-stick pan spray.

Vegetables

- Toss your vegetables lightly in oil before cooking to improve browning.

Steam Function

The Steam mode heats food gradually, using the oven heating elements and moist steam heat.

This is an ideal cooking method for delicate food items such as seafood, which can lose nutrients when boiled.

The oven provides 2 methods of steam cooking: Steam Bake, and Steam Roast.

CAUTION

- Take care when opening the oven door during or after steam cooking. Hot steam can cause scalding.

Using the Steam Feeder Tank

The steam feeder tank is located over the oven cavity.

- 1 Gently push the front of the steam feeder tank to slide it out.

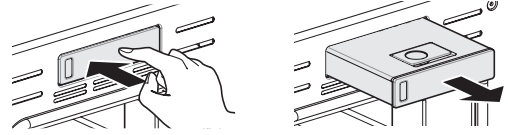

CAUTION

- During operation, the steam feeder tank can become very hot to the touch. Always use oven gloves when removing the tank during or after cooking.

- 2 Remove the tank and place it on a flat surface.
- 3 Remove the tank cover or flip open the fill lid at the front of the tank cover.
- 4 Fill the tank to the max line located at the front of the tank. Use softened, filtered water, if possible. Hard water may clog the steam generator more quickly with scale buildup.

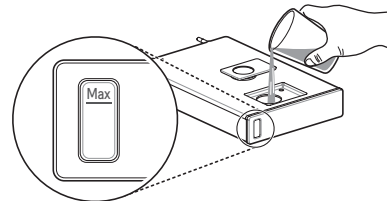

MAX LINE

- 5 Assemble the cover or snap closed the fill lid.

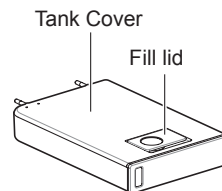

CAUTION

- Make sure the tank cover and fill lid are closed before putting in the oven.

- 6 Carefully insert the tank into the steam feeder slot, making sure to keep the tank level while carrying it. If the tank is not kept level, water will drain out of the tubes in the back.
- 7 Slide the tank into the slot until it clicks into place.

Setting Steam Function

Example: To steam cook at 375 °F

- 1** Touch **Steam Bake** or **Steam Roast**.
- 2** Touch **Steam Level** repeatedly until desired steam level appears in the display: Low, Med, or High.
- 3** Touch **Start**. The display shows 350 °F.
- 4** Set the oven temperature: touch **3**, **7** and **5**. If desired, set the cook time and delayed start time.
- 5** Touch **Start**. The display shows **Steam Bake** or **Steam Roast** and the oven temperature starting at 100 °F.
- 6** Once cooking is finished, allow oven to cool completely, then wipe up any water left on oven interior.

Once Steam function is started, an indicator on the display shows the status of the steam function. Make sure the steam feeder tank is filled with water before starting the Steam Bake or Steam Roast function. If the water in the tank runs out during cooking, a chime sounds and **Fill the water** shows in the display. The oven continues to cook without steam.

NOTE

- Remember to drain the steam feeder tank after use.
- It is normal to hear the sound of boiling water from the steam generator while running the steam functions.
- If mineral deposits remain on the oven bottom after steam mode, use a cloth or sponge soaked in vinegar or a weak citric acid solution to remove them before using the steam mode again. See the Maintenance section under Descaling for more info. To remove stubborn hard water scale, use the Descaling function.
- Wipe away excess water left over after cooling.
- To avoid damage and extent product life, descale the steam feeder after every 10 hours of use, or more often if needed.
- After the steam mode is used for 8 hours, a reminder to descale the product appears in the display the next time the steam mode is selected. You will not be able to use the steam mode until the Descaling function is run. To avoid this delay, run the Descaling function after every 2-3 uses of the steam mode.
- If the descaling reminder appears, touch **start** to run the Descaling function.

Warm

The WARM function maintains an oven temperature of less than 230°F. This function should not be used to reheat cold food. The Warm function keeps cooked food warm for serving up to 3 hours after cooking has finished.

After 3 hours the WARM function shuts the oven OFF automatically.

Setting the Warm Function

- 1** Touch **More Mode**.
- 2** Touch **2** to select WARM.
- 3** Select the temperature level: touch **1** for high, **2** for medium, or **3** for low.
- 4** Touch **Start** to start warming.
- 5** Touch **Clear/Off** at any time to cancel.

NOTE

- The Warm function is intended to keep food warm. Do not use it to cool food down.
- It is normal for the fan to operate during the Warm function.

Proof

This feature maintains a warm oven for rising yeast leavened products before baking.

Setting the Proof Function

- 1 Use rack position 2 or 3 for proofing.
- 2 Touch **More Mode**.
- 3 Touch **3** to select PROOF.
- 4 Enter the proofing time, if desired, and touch **Start**.
- 5 Touch **Clear/Off** at any time to cancel.

NOTE

- To avoid lowering the oven temperature and lengthening proofing time, do not open the oven door unnecessarily. Check bread products early to avoid over proofing.
- Do not use the proofing mode for warming food or keeping food hot. The proofing oven temperature is not hot enough to keep foods at safe temperatures. Use the Warm feature to keep food warm. Proofing does not operate when the oven is above 125 °F. **OVEN IS HOT** shows in the display.
- It is normal for the fan to operate during the Proof function.

Probe

The probe accurately measures the internal temperature of meat, poultry and casseroles. It should not be used during broiling, self clean, warming or proofing. Always unplug and remove the probe from the oven when removing food. Before using, insert the probe into the center of the thickest part of the meat or into the inner thigh or breast of poultry, away from fat or bones. Place the food in the oven and connect the probe to the jack. Keep the probe as far away from heat sources as possible.

- The probe cannot be used in Broil, Self Clean, Easy Clean®, Warm or Proof modes.
- For thin cuts of meat, insert probe in thickest side of meat.

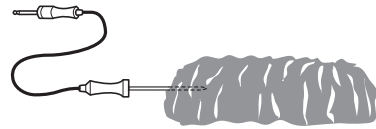

Recommended Probe Placement Chart

Category	Examples of Food	Probe Placement
Ground Meat & Meat Mixtures	Meatloaf	Insert in the thickest part
	Meatballs	
Fresh Beef, Veal, Lamb	Steaks, Roasts, Chops	Insert in the thickest part, away from bone, fat and gristle
Poultry	Whole Chicken or Turkey	Insert in the thickest part of thigh, avoiding bone
	Poultry Breasts or Roasts	
	Duck, Goose, Pheasant	
	Stuffing (Alone or in Bird)	Insert in the thickest part of the dish
Pork & Ham	Fresh Pork	Insert in the thickest part, away from bone, fat and gristle
	Fresh Ham (Raw)	
	Precooked Ham (Reheat & Serve)	
Leftovers & Casseroles	Leftovers	Insert in the thickest part of the dish
	Casseroles	
Seafood	Whole Fish	Insert in the thickest part of the fish
	Fish Fillet (Side of Fish)	
	Fish Steaks or Portions	

Using the Probe

- 1 Insert the probe into the food.
- 2 Connect the probe to the jack in the oven.
- 3 Touch an appropriate cooking mode.
- 4 Touch the numbers to set the oven temperature.
- 5 Touch **Start** or **Probe**. PRESS START OR ENTER PROBE TEMP / 80F – 210F appears in the display.
- 6 Touch numbers to set the probe temperature. The default probe temperature is 150 °F (65 °C), but can be changed to any temperature between 80 °F (27 °C) and 210 °F (100 °C)
- 7 Touch **Start**. The display shows the changing probe temperature.
- 8 When the set probe temperature is reached, the oven shuts off automatically.
- 9 Touch **Clear/Off** at any time to stop cooking.

Changing the Probe Temperature while Cooking

- 1 Touch **Probe**.
- 2 Set the probe temperature.
- 3 Touch **Start**.

**CAUTION**

- Always use an oven mitt to remove the temperature probe. Do not touch the broil element. Failure to obey this caution can result in severe personal injury.
- To avoid damage to the meat probe, do not use tongs to pull on the probe when removing it.
- Do not store the meat probe in the oven.
- To avoid breaking the probe, make sure food is completely defrosted before inserting.

Recommended Probe Temperature Chart

Category	Examples of Food	Target Internal Temp.	Desired Doneness
Ground Meat & Meat Mixtures	Meatloaf	160 °F (71 °C)	
	Meatballs	165 °F (74 °C)	
Fresh Beef, Veal, Lamb	Steaks, Roasts, Chops	145 °F (63 °C)	Rare: 130 °F (54 °C) Medium Rare: 140 °F (60 °C) Medium: 150 °F (66 °C) Well Done: 160 °F (71 °C)
Poultry	Whole Chicken or Turkey	165 °F (74 °C)	
	Poultry Breasts or Roasts		
	Duck, Goose, Pheasant		
	Stuffing (Alone or in Bird)		
Pork & Ham	Fresh Pork	145 °F (63 °C)	Well Done: 170 °F (77 °C)
	Fresh Ham (Raw)		Well Done: 160 °F (71 °C)
	Precooked Ham (Reheat & Serve)	140 °F (60 °C)	
Leftovers & Casseroles	Leftovers	165 °F (74 °C)	
	Casseroles		
Seafood	Whole Fish	145 °F (63 °C)	
	Fish Fillet (Side of Fish)		
	Fish Steaks or Portions		

Favorite

The Favorite feature is used to record and recall favorite recipe settings. This feature can store and recall up to 3 different settings. The Favorite feature can be used with the Cook Time mode. It will not work with any other function including the Start Time (delayed cook) mode.

- 1 Place the food in the oven.
- 2 Touch **More Mode**.
- 3 Touch **1** to select FAVORITE.
- 4 Touch **More Mode** repeatedly until desired recipe appears in the display: Bread, Meat or Chicken.
- 5 Touch the numbers to set the desired oven temperature. This temperature is stored and recalled when next used.
- 6 Touch **Start**. The preheat indicator beeps 3 times when the oven reaches the set temperature.

Category	Default Temp. (may be changed and recalled)	Operating Feature
1. Bread	375 °F	BAKE
2. Meat	325 °F	Convection Roast
3. Chicken	350 °F	Convection Roast

NOTE

- Only the selected temperature is stored, not the cooking time.
- If the oven temperature is changed, the changed temperature is stored.

Sabbath Mode

Sabbath mode is used on the Jewish Sabbath and Holidays.

While the oven is in Sabbath mode, the temperature cannot be changed and the timer, light, and alarm functions are disabled. If the oven light is on when the oven is put in Sabbath mode, it will remain on.

Sabbath mode is only available when upper oven is not operating and lower oven is in Bake mode. All function buttons, except for the CLEAR/OFF is inactive.

Setting Sabbath Mode

- 1 Disconnect the probe. The Probe function is not available in Sabbath mode.
- 2 Touch **Bake** and set the desired temperature and cook time. Any cook time can be set from 1 minute to 73 hours 59 minutes.
- 3 Touch **Start**.
- 4 Touch and hold **More Mode** for three seconds. **SB** and appears in the display when the Sabbath mode is activated.
- 5 To stop Sabbath mode, touch and hold **More Mode** for three seconds. To cancel the Bake function, touch **Clear/Off** at any time.

NOTE

- If a cook time is set, the oven turns off automatically at the end of the cook time, without chiming. The oven remains in Sabbath mode, but is turned off.
- If no cook time is set, the oven will not automatically turn off.
- After a power failure, the display will turn back on in Sabbath mode, but the oven will be off.
- During Sabbath mode, the upper oven functions are blocked and Wi-Fi network cannot be connected.

Wi-Fi

Connect the appliance to a home Wi-Fi network to use Remote Start and other smart functions. See the Smart Functions section for more details.

Setting Up Wi-Fi

- 1 Touch and hold **Remote Start** key for three seconds.
The Wi-Fi icon  appears at the bottom of the display.

Remote Start

If the appliance is registered on a home Wi-Fi network, the preheating function of the oven can be started or stopped using the LG SmartThinQ Application.

Preparing the Oven for a Remote Start

- 1 Touch **Remote Start**. **REMOTE READY** and Wi-Fi icon  show in the display. In this mode, the controls for both ovens are locked.
- 2 Follow the instructions in the LG SmartThinQ application for using the Remote Start function.

NOTE



- Remote Start is disconnected in the following situations:
 - Remote Start is never set up in the smart phone app.
 - The Remote Start status is “ready”.
 - Remote Start experiences a problem during operation.
- The Wi-Fi icon on the display shows the status of the appliance's network connection. If the Wi-Fi icon is not lit, use the smart phone app to select the Wi-Fi network or register the product again.
- A faulty Wi-Fi connection could delay the Remote Start function.
- Disconnect the probe if attached.

SMART FUNCTIONS

LG SmartThinQ Application

The LG SmartThinQ application allows you to communicate with the appliance using a smartphone.

Before Using LG SmartThinQ

- For appliances with the  or  logo
- 1 Use a smartphone to check the strength of the wireless router (Wi-Fi network) near the appliance.
 - If the distance between the appliance and the wireless router is too far, the signal strength becomes weak. It may take a long time to register or installation may fail.
 - 2 Turn off the **Mobile data** or **Cellular Data** on your smartphone.
 - For iPhones, turn data off by going to **Settings** → **Cellular** → **Cellular Data**.

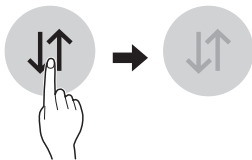

- 3 Connect your smartphone to the wireless router.

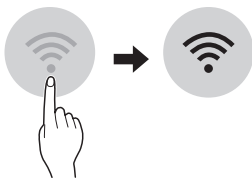

NOTE

- To verify the Wi-Fi connection, check that **Wi-Fi**  icon on the control panel is lit.
- The appliance supports 2.4 GHz Wi-Fi networks only. To check your network frequency, contact your Internet service provider or refer to your wireless router manual.
- LG SmartThinQ is not responsible for any network connection problems or any faults, malfunctions, or errors caused by network connection.
- The surrounding wireless environment can make the wireless network service run slowly.

NOTE

- If the appliance is having trouble connecting to the Wi-Fi network, it may be too far from the router. Purchase a Wi-Fi repeater (range extender) to improve the Wi-Fi signal strength.
- The network connection may not work properly depending on the Internet service provider.
- The Wi-Fi connection may not connect or may be interrupted because of the home network environment.
- If the appliance cannot be registered due to problems with the wireless signal transmission, unplug the appliance and wait about a minute before trying again.
- If the firewall on your wireless router is enabled, disable the firewall or add an exception to it.
- The wireless network name (SSID) should be a combination of English letters and numbers. (Do not use special characters.)
- Smartphone user interface (UI) may vary depending on the mobile operating system (OS) and the manufacturer.
- If the security protocol of the router is set to **WEP**, network setup may fail. Change the security protocol (**WPA2** is recommended), and register the product again.

Installing the LG SmartThinQ Application

Search for the LG SmartThinQ application from the Google Play Store or Apple App Store on a smart phone. Follow instructions to download and install the application.

LG SmartThinQ Application Features

- For appliances with the  or  logo

EasyClean®

Allows you to set EasyClean® alerts, read the instruction guide, and simulate and compare energy consumption when using EasyClean® versus selfclean cycles.

Smart Diagnosis™

This function provides useful information for diagnosing and solving issues with the appliance based on the pattern of use.

Settings

Allows you to set various options on the oven and in the Application.

Monitoring

This function shows the current status, remaining time, cook settings and end time on one screen.

Push Alerts

Turn on the Push Alerts to receive appliance status notifications.

The notifications are triggered even if the LG SmartThinQ application is off.

Timer

You can set the timer from the application.

Firmware Update

Keep the appliance updated.

NOTE

- If you change your wireless router, Internet service provider, or password, delete the registered appliance from the LG SmartThinQ application and register it again.
- This information is current at the time of publication. The application is subject to change for product improvement purposes without notice to users.

Smart Diagnosis™ Function

Should you experience any problems with the appliance, it has the capability of transmitting data via your telephone to the LG Customer Information Center. NFC or Wi-Fi equipped models can also transmit data to a smartphone using the LG SmartThinQ application.

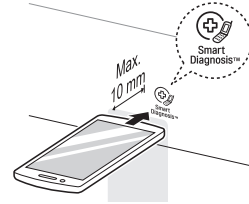

Smart Diagnosis™ through the Customer Information Center

- For appliances with the  or  logo

This method allows you to speak directly to our trained specialists. The specialist records the data transmitted from the appliance and uses it to analyze the issue, providing a fast and effective diagnosis.

- 1 Call the LG Customer Information Center at 1-800-243-0000.
- 2 When instructed to do so by the call center agent, hold the mouthpiece of your phone over the Smart Diagnosis™ logo on the machine. Hold the phone no more than one inch from (but not touching) the machine.

NOTE

Do not touch any other buttons or icons on the display screen.

- 3 Touch and hold the **Start** button for three seconds.
- 4 Keep the phone in place until the tone transmission has finished. This takes about 6 seconds and the display will count down the time.
- 5 Once the countdown is over and the tones have stopped, resume your conversation with the call center agent, who will then be able to assist you in using the information transmitted for analysis.

NOTE

- For best results, do not move the phone while the tones are being transmitted.
- If the call center agent is not able to get an accurate recording of the data, you may be asked to try again.

LG SmartThinQ Smart Diagnosis™

- For appliances with the  or  logo

Use the Smart Diagnosis feature in the LG SmartThinQ application for help diagnosing issues with the appliance without the assistance of the LG Customer Information Center.

Follow the instructions in the LG SmartThinQ application to perform a Smart Diagnosis using your smartphone.

- 1 Open the LG SmartThinQ application on the smart phone.
- 2 In the application, select the appliance from your list of connected appliances and then touch the dots at the upper right of the screen.
- 3 Select **Smart Diagnosis**, then touch the **Start Smart Diagnosis** button.

NOTE

If the diagnosis fails several times, use the following instructions.

- 4 Select the **Audible Diagnosis**.
- 5 Follow the instructions on the smart phone.
- 6 Keep the phone in place until the tone transmission has finished. View the diagnosis on the phone.

NOTE

- Smart Diagnosis™ cannot be activated unless the appliance can be turned on using the **Power** button. If the appliance cannot be turned on, troubleshooting must be done without using Smart Diagnosis™.
- The Smart Diagnosis™ function depends on the local call quality.
- A landline phone may result in clearer transmission and more accurate diagnosis.
- If the Smart Diagnosis™ data transfer is poor due to poor call quality, you may not receive an accurate Smart Diagnosis result.

Open Source Software Notice Information

To obtain the source code under GPL, LGPL, MPL, and other open source licenses, that is contained in this product, please visit <http://opensource.lge.com>. In addition to the source code, all referred license terms, warranty disclaimers and copyright notices are available for download.

LG Electronics will also provide open source code to you on CD-ROM for a charge covering the cost of performing such distribution (such as the cost of media, shipping, and handling) upon email request to opensource@lge.com. This offer is valid for a period of three years after our last shipment of this product. This offer is valid to anyone in receipt of this information.

Wireless module (LCW-004) Specifications

Frequency Range	2412~2462 MHz
Output Power (max.)	IEEE 802.11 b : 22.44 dBm
	IEEE 802.11 g : 24.68 dBm
	IEEE 802.11 n : 24.11 dBm

FCC Notice (For transmitter module contained in this product)

The following notice covers the transmitter module contained in this product.

This equipment has been tested and found to comply with the limits for a Class B digital device, pursuant to Part 15 of the FCC Rules and also Part 18 of the FCC Rules. These limits are designed to provide reasonable protection against harmful interference in a residential installation. This equipment generates, uses, and can radiate radio frequency energy and, if not installed and used in accordance with the instructions, may cause harmful interference to radio communications. However, there is no guarantee that interference will not occur in a particular installation. If this equipment does cause harmful interference to radio or television reception, which can be determined by turning the equipment off and on, the user is encouraged to try to correct the interference by one or more of the following measures:

- Reorient or relocate the receiving antenna.
- Increase the separation between the equipment and the receiver.
- Connect the equipment to an outlet on a circuit different from that to which the receiver is connected.
- Consult the dealer or an experienced radio/TV technician for help.

This device complies with Part 15, Part 18 of the FCC Rules. Operation is subject to the following two conditions:

- 1) this device may not cause harmful interference and
- 2) this device must accept any interference received, including interference that may cause undesired operation of the device.

Any changes or modifications in construction of this device which are not expressly approved by the party responsible for compliance could void the user's authority to operate the equipment.

FCC RF Radiation Exposure Statement

This equipment complies with FCC radiation exposure limits set forth for an uncontrolled environment. This transmitter must not be co-located or operating in conjunction with any other antenna or transmitter.

This equipment should be installed and operated with a minimum distance of 20 cm (7.8 inches) between the antenna and your body. Users must follow the specific operating instructions for satisfying RF exposure compliance.

MAINTENANCE

Caring for the Upper Oven

To make sure the microwave oven looks good and works well for a long time, maintain it properly. For proper care, follow these instructions carefully.

Cleaning the Interior

Wash often with warm, sudsy water and a sponge or soft cloth. Use only mild, nonabrasive soaps or a mild detergent. **Keep the areas clean where the door and oven frame touch when closed.**

Wipe well with a clean cloth. Over time, stains can occur on the surfaces as the result of food particles spattering during cooking. This is normal.

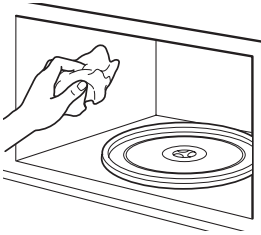

For stubborn soil, boil a cup of water in the oven for 2 to 3 minutes. Steam will soften the soil. To get rid of odors inside the oven, boil a cup of water with some lemon juice or vinegar in it.

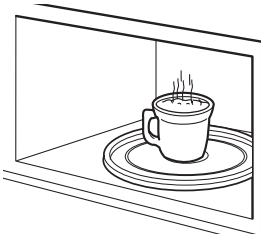

Cleaning the Exterior

Use a soft cloth sprayed with glass cleaner.

Apply the glass cleaner to the soft cloth; do not spray directly on the oven.

NOTE

Abrasive cleansers, steel wool pads, gritty wash cloths, some paper towels, etc., can damage the control panel and the interior and exterior oven surfaces.

To clean the glass tray and rotating ring, wash in mild, sudsy water.

For heavily soiled areas use a mild cleanser and scouring sponge.

The glass tray and rotating ring are dishwasher safe.

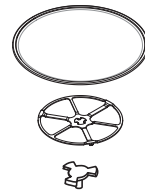

Glass Tray

Rotating Ring

Shaft

Caring for the Lower Oven

EasyClean®

LG's EasyClean® enamel technology provides two cleaning options for the inside of the lower oven. The EasyClean® feature takes advantage of LG's new enamel to help lift soils without harsh chemicals, and it runs using ONLY WATER for just 10 minutes in low temperatures to help loosen LIGHT soils before hand-cleaning.

While EasyClean® is quick and effective for small and LIGHT soils, the Self Clean feature can be used to remove HEAVY, built up soils. The intensity and high heat of the Self Clean cycle may result in smoke which will require the opening up of windows to provide ventilation. Compared to the more intense Self Clean process, your LG oven gives you the option of cleaning with LESS HEAT, LESS TIME, and virtually NO SMOKE OR FUMES.

When needed, the oven still provides the Self Clean option for longer, more thorough oven cleaning for heavier, built up soils.

Benefits of EasyClean®

- Helps loosen light soils before hand-cleaning
- EasyClean® only uses water; no chemical cleaners
- Makes for a better self-clean experience
 - Delays the need for a self-clean cycle
 - Minimizes smoke and odors
 - Can allow shorter self-clean time

When to Use EasyClean®

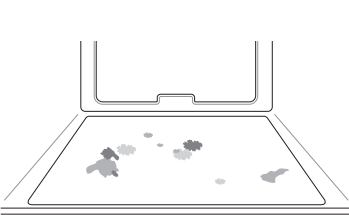
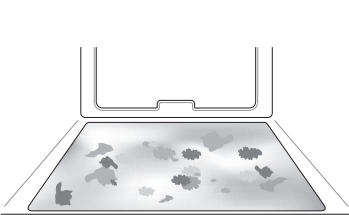
Suggested Cleaning Method	Example of Oven Soiling	Soil Pattern	Types of Soils	Common Food Items That Can Soil Your Oven
EasyClean®		Small drops or spots	Cheese or other ingredients	Pizza
		Light splatter	Fat/grease	Steaks, broiled
				Fish, broiled
Self Clean*		Medium to heavy splatter	Fat/grease	Meat roasted at high temperatures
		Drops or spots	Filling or sugar based soils	Pies
			Cream or tomato sauce	Casseroles

* The Self Clean cycle can be used for soil that has been built up over time.

Cleaning Tips

- Allow the oven to cool to room temperature before using the EasyClean® cycle. If your oven cavity is above 150 °F (65 °C), **OVEN IS HOT** will appear in the display, and the EasyClean® cycle will not be activated until the oven cavity cools down.
- A plastic spatula can be used as a scraper to scrape off any chunks or debris before and during oven cleaning.
- Using the rough side of a non-scratch scouring pad may help to take off burnt-on stains better than a soft sponge or towel.
- Certain non-scratch scrubbing sponges, such as those made of melamine foam, available at your local stores, can also help improve cleaning.
- The Oven must be level to ensure that the lower surface of the oven cavity is completely covered with water at the beginning of the EasyClean® cycle.
- For best results, use distilled or filtered water. Tap water may leave mineral deposits on the oven bottom.
- Soil baked on through several cooking cycles will be more difficult to remove with the EasyClean® cycle.
- Do not open the oven door during the EasyClean® cycle. Water will not get hot enough if the door is opened during the cycle.
- For hard to reach areas such as the back surface of the oven, it is better to use the Self Clean cycle.

EasyClean® Instruction Guide

- 1 Remove oven racks and accessories from the oven.
- 2 Scrape off and remove any burnt-on debris with a plastic scraper.

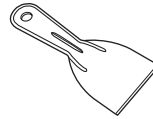

Suggested plastic scrapers:

- Hard plastic spatula
- Plastic pan scraper
- Plastic paint scraper
- Old credit card

- 3 Fill the steam feeder tank with water to the maximum fill line (34 oz/1000 cc).
- 4 Close the oven door. Touch **EasyClean®**. Touch **Start**.

CAUTION

- Some surfaces may be hot after the EasyClean® cycle. Wear rubber gloves while cleaning to prevent burns.
- During the EasyClean® cycle, the oven becomes hot enough to cause burns. After the cycle ends, open the oven door and wait a minute to let the steam run out before wiping the inside surface of the oven. Failure to do so may result in burns.
- Avoid leaning or resting on the oven door glass while cleaning the oven cavity.

- 5 A tone will sound at the end of the 10 minute cycle. Touch **Clear/Off** to clear the display and end the tone.
- 6 After the cleaning cycle and during hand-cleaning, enough water should remain on the oven bottom to completely submerge all soils. Add water if necessary. Place a towel on the floor in front of the oven to capture any water that may spill out during hand-cleaning.
- 7 Clean the oven cavity immediately after the EasyClean® cycle by scrubbing with a wet, non-scratch scouring sponge or pad. (The scouring side will not scratch the finish.) Some water may spill into the bottom vents while cleaning, but it will be captured in a pan under the oven cavity and will not hurt the burner.

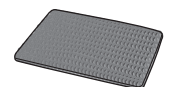

NOTE

Do not use any steel scouring pads, abrasive pads or cleaners as these materials can permanently damage the oven surface.

- 8 Once the oven cavity is cleaned, wipe any excess water with a clean dry towel. Replace racks and any other accessories.
- 9 If some light soils remain, repeat the above steps, making sure to thoroughly soak the soiled areas.

If stubborn soils remain after multiple EasyClean® cycles, run the Self Clean cycle. Be sure that the oven cavity is empty of oven racks and other accessories, and that the oven cavity surface is dry before running the Self Clean cycle. Consult the Self Clean section of your owner's manual for further details.

NOTE

- The cavity gasket may be wet when the EasyClean® cycle finishes. This is normal. Do not clean the gasket.
- If mineral deposits remain on the oven bottom after cleaning, use a cloth or sponge soaked in vinegar to remove them.
- It is normal for the fan to operate during the EasyClean® cycle.
- It is normal to hear the sound of boiling water from the steam generator while running the EasyClean® cycle.

Steam Feeder Tank

The steam feeder tank is used during the steam cooking functions. Use filtered, softened water if possible.

NOTE

- After using the steam function, the steam feeder tank should be drained. To avoid bacteria or odors, clean and dry the steam feeder tank after every use.
- Do not clean in a dishwasher.

Hard Water Scale

If hard water is used in the steam feeder tank, the steam generator may become clogged with hard water scale. In areas with hard water, run the Descaling function frequently or use softened water.

Cleaning Scale on Oven Bottom

To remove mineral deposits that remain on the oven bottom after using the steam mode, use a cloth or sponge soaked in vinegar or a weak citric acid solution. For more stubborn or extensive scaling, use the Descaling function.

Descaling

Use this function to remove the white deposits that form after the steam generator is used for a long period.

The Descaling function runs for 65 minutes. Water will come out of the steam generator while it is being cleaned.

For instructions on removing and filling the steam feeder tank, see "Using the Steam Feeder Tank."

Using Descaling

- 1 Fill the steam feeder tank with a 20:1 mixture of water and citric acid. For example, use 4 tsp of citric acid in 4¹/₄ cups water (20 g citric acid in 1000 ml water).
- 2 Insert the steam feeder tank into the slot over the oven cavity and push it in until it clicks into place.
- 3 Touch **More Mode**.
- 4 Touch **4** to select DESCALING.
- 5 After a few minutes of descaling, **Insert the water tank** will appear in the display. Following the instructions, drain the tank and fill it with clean water.
- 6 Insert the tank and start the Rinsing function.
- 7 Once the Rinsing function is complete, dry the inside of the oven with a soft cloth.

NOTE

The Rinsing function must be completed even if the Descaling function is canceled.

Drying

The Drying function removes residual water inside the steam generator. The function takes a little over 1 minute and runs automatically after any steam cooking cycle. The Drying function can also be started manually, if needed.

Using Drying

- 1 Check whether there is water in the steam feeder tank. The remaining water in the tank must be drained.
- 2 Touch **More Mode**.
- 3 Touch **5** to select DRYING.
- 4 Touch **Start** to begin Drying. The remaining time appears in the display.

Self Clean

The Self Clean cycle uses extremely hot temperatures to clean the oven cavity. While running the Self Clean cycle, you may notice smoking or an odor. This is normal; especially if the oven is heavily soiled.

During Self Clean, the kitchen should be well ventilated to minimize the odors from cleaning.

Before Starting Self Clean

- Remove the oven racks, broiler pan, broiler grid, all cookware, aluminum foil or any other material from the oven.
- The kitchen should be well ventilated to minimize the odors from cleaning.
- Wipe any heavy spillovers on the bottom of the oven.
- Make sure that the oven light bulb cover is in place and the oven light is off.
- The oven light cannot be turned on during a Self Clean cycle. The oven light cannot be turned on until the oven temperature has cooled below 500 °F (260 °C) after a Self Clean cycle is complete.

CAUTION

- Do not leave small children unattended near the appliance. During the Self Clean cycle, the outside of the oven can become very hot to the touch.
- If you have pet birds, move them to another well-ventilated room. The health of some birds is extremely sensitive to the fumes given off during the Self Clean cycle of any oven.
- Do not line the oven walls, racks, bottom or any other part of the oven with aluminum foil or any other material. Doing so will destroy heat distribution, produce poor baking results and cause permanent damage to the oven interior (aluminum foil will melt to the interior surface of the oven).
- Do not force the door open. This can damage the automatic door locking system. Use care when opening the oven door after the Self Clean cycle. Stand to the side of the oven when opening the door to allow hot air or steam to escape. The oven may still be VERY HOT.

NOTE

- Remove oven racks and accessories before starting the Self Clean cycle.
- If oven racks are left in the oven cavity during the Self Clean cycle, they will discolor and become difficult to slide in and out.
- Clean the frame of the oven and door with hot soapy water. Rinse well.
- Do not clean the gasket. The fiberglass material of the oven door gasket cannot withstand abrasion. It is essential for the gasket to remain intact. If you notice it becoming worn or frayed, replace it.
- Wipe up any heavy spillovers on the oven bottom.
- Make sure that the oven light bulb cover is in place and the oven light is off.
- It is normal for the fan to operate during the Self Clean cycle.

Setting Self Clean

The Self Clean function has cycle times of 3, 4, or 5 hours.

Self Clean Soil Guide

Soil Level	Cycle Setting
Lightly Soiled Oven Cavity	3-Hour Self Clean
Moderately Soiled Oven Cavity	4-Hour Self Clean
Heavily Soiled Oven Cavity	5-Hour Self Clean

- 1 Remove all racks and accessories from the oven.
- 2 Touch **Self Clean**. The oven defaults to the recommended four-hour self clean for a moderately soiled oven. Touch twice for a five-hour self clean or three times for a three-hour self clean.
- 3 Touch **Start**.
- 4 Once the self-clean cycle is set, the oven door locks automatically and the lock icon displays. You will not be able to open the oven door until the oven has cooled. The lock releases automatically when the oven has cooled.



CAUTION

Do not force the oven door open when the lock icon is displayed. The oven door remains locked until the oven temperature has cooled. Forcing the door open will damage the door.

Setting Self Clean with a Delayed Start

- 1 Remove all racks and accessories from the oven.
- 2 Touch **Self Clean**. The oven defaults to the recommended four-hour self clean for a moderately soiled oven. Touch twice for a five-hour self clean or three times for a three-hour self clean.
- 3 Touch **Start Time**.
- 4 Use the number keys to enter the time of day you would like the Self Clean to start.
- 5 Touch **Start**.

NOTE

It may become necessary to cancel or interrupt a Self Clean cycle due to excessive smoke or fire in the oven. To cancel the Self Clean function, touch **Clear/Off**.

During Self Clean

- The Self Clean cycle uses extremely hot temperatures to clean the oven cavity. While running the Self Clean cycle, you may notice smoking or an odor. This is normal, especially if the oven is heavily soiled.
- As the oven heats, you may hear sounds of metal parts expanding and contracting. This is normal and will not damage the oven.
- Do not force the oven door open when the lock  is displayed. The oven door remains locked until the oven temperature has cooled. Forcing the door open will damage the door.
- Do not remove the steam feeder tank from the oven during the self-clean cycle. Doing so, could result in product damage.

After the Self Clean Cycle

- The oven door remains locked until the oven temperature has cooled.
- You may notice some white ash in the oven. Wipe it off with a damp cloth or a soap-filled pad after the oven cools. If the oven is not clean after one self-clean cycle, repeat the cycle.
- If oven racks were left in the oven and do not slide smoothly after a self-clean cycle, wipe racks and rack supports with a small amount of vegetable oil to make them glide more easily.
- Fine lines may appear in the porcelain because it went through heating and cooling. This is normal and will not affect performance.

NOTE

- The Self Clean cycle cannot be started if the Lockout feature is active.
- Once the Self Clean cycle is set, the oven door locks automatically. You will not be able to open the oven door until the oven is cooled. The lock releases automatically.
- Once the door has been locked, the lock  indicator light stops flashing and remains on. Allow about 15 seconds for the oven door lock to activate.
- If the clock is set for a 12-hour display (default) the Delayed Self Clean can never be set to start more than 12 hours in advance.
- After the oven is turned off, the convection fan keeps operating until the oven has cooled down.

Changing the Oven Light

The oven light is a standard 50-watt appliance bulb. It turns on when the oven door is open. When the oven door is closed, touch **Light** to turn it on or off.

Replacing Lamp on Side Wall

- 1 Unplug oven or disconnect power.
- 2 Remove oven racks.
- 3 Slide a flat blade screwdriver between the housing and the glass light cover.
- 4 Support the glass light cover with two fingers to prevent the cover from falling to the bottom of the oven.

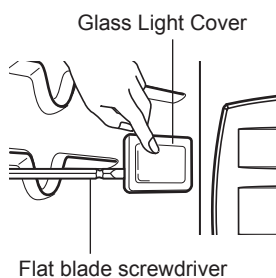

- 5 Gently twist the screwdriver blade to loosen the glass light cover.

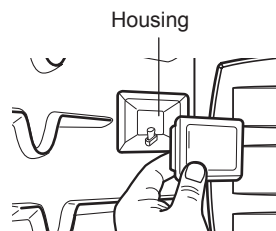

- 6 Remove bulb from socket.
- 7 Replace bulb, replace light cover by snapping back into place.
- 8 Plug in oven or reconnect power.

! WARNING

- Make sure that the oven and bulb are cool.
- Disconnect the electrical power to the oven at the main fuse or circuit breaker panel. Failure to do so can result in severe personal injury, death, or electrical shock.
- Wear gloves while changing the oven light. Glass fragments from broken bulbs can cause risk of injury.

Cleaning the Exterior

Painted and Decorative Trim

For general cleaning, use a cloth with hot soapy water. For more difficult soils and built-up grease, apply a liquid detergent directly onto the soil. Leave it on for 30 to 60 minutes. Rinse with a damp cloth and dry. Do not use abrasive cleaners.

Stainless Steel Surfaces

To avoid scratches, do not use steel wool pads.

- 1 Place a small amount of stainless steel appliance cleaner or polish on a damp cloth or paper towel.
- 2 Clean a small area, rubbing with the grain of the stainless steel if applicable.
- 3 Dry and buff with a clean, dry paper towel or soft cloth.
- 4 Repeat as necessary.

NOTE

- Do not use a steel wool pad. It will scratch the surface.
- To clean the stainless steel surface, use warm sudsy water or a stainless steel cleaner or polish.
- Always wipe in the direction of the metal surface finish.
- To purchase stainless steel appliance cleaner or polish, or to locate a dealer near you, call our toll-free customer service number: 1-800-243-0000 (USA), or visit our website at: www.lg.com

Oven Door

- Use soapy water to thoroughly clean the oven door. Rinse well. Do not immerse the door in water.
- You may use a glass cleaner on the outside glass of the oven door. Do not spray water or glass cleaner on the door vents.
- Do not use oven cleaners, cleaning powders, or harsh abrasive cleaning materials on the outside of the oven door.
- Do not clean the oven door gasket. The oven door gasket is made of a woven material that is essential for a good seal. Care should be taken not to rub, damage, or remove this gasket.



CAUTION

Do not use harsh cleaners or harsh abrasive cleaning materials on the outside of the oven door. Doing so can cause damage.

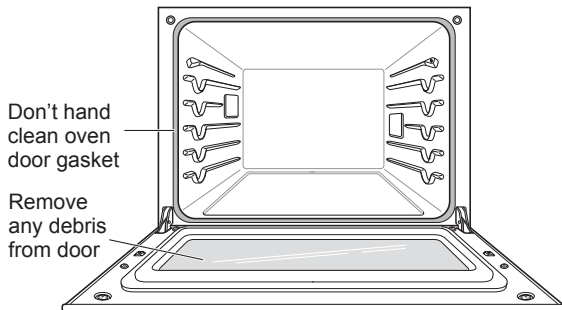

Broiler Pan and Grid

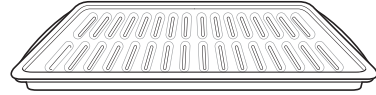

- Do not store a soiled broiler pan or grid anywhere in the oven.
- Do not clean the broiler pan or grid in a self-cleaning mode.
- Remove the grid from the pan. Carefully pour out the grease from the pan into a proper container.
- Wash and rinse the broiler pan and grid in hot water with a soap-filled or plastic scouring pad.
- If food has burned on, sprinkle the grid with cleaner while hot and cover with wet paper towels or a dishcloth. Soaking the pan will remove burned-on foods.
- Both the broiler pan and grid may be cleaned with a commercial oven cleaner or in the dishwasher.

Oven Racks

Remove the oven racks before operating the self clean cycle.

- 1 Food spilled into the tracks could cause the racks to become stuck. Clean racks with a mild, abrasive cleaner.
- 2 Rinse with clean water and dry.

NOTE

If the racks are cleaned using the self clean cycle (not recommended), the color will turn slightly blue and the finish will become dull. After the self clean cycle is complete, and the oven has cooled, rub the sides of the racks with wax paper or a cloth containing a small amount of vegetable oil. This will make the racks glide more easily into the rack tracks.

Removing and Replacing the Lift-Off Oven Doors

CAUTION

- Be careful when removing and lifting the door.
- Do not lift the door by the handle. The door is very heavy.

Removing the Door

- 1 Open the door fully.
- 2 Pull the hinge locks down toward the door frame to the unlocked position.

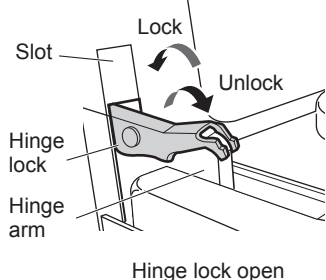

- 3 Firmly grasp both sides of the door at the top.
- 4 Close door to the door removal position, which is approximately 5 degrees.

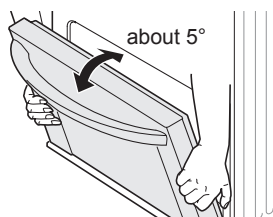

- 5 Lift door up and out until the hinge arm is clear of the slot.

Replacing the Door

- 1 Firmly grasp both sides of the door at the top.
- 2 With the door at the same angle as the removal position, seat the indentation of the hinge arm into the bottom edge of the hinge slot. The notch in the hinge arm must be fully seated into the bottom of the slot.

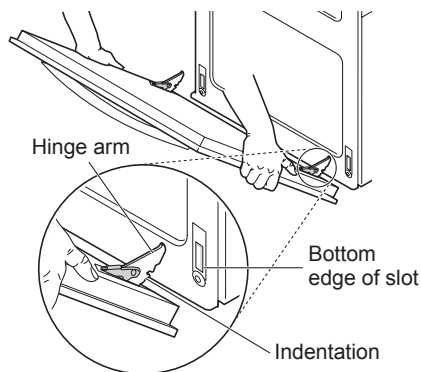

- 3 Open the door fully. If the door will not open fully, the indentation is not seated correctly in the bottom edge of the slot.
- 4 Push the hinge locks up against the front frame of the oven cavity to the locked position.

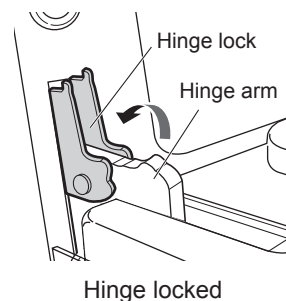

- 5 Close the oven door.

Door Care Instructions

Most oven doors contain glass that can break.

CAUTION

- Do not close the oven door until all the oven racks are fully in place.
- Do not hit the glass with pots, pans, or any other object.
- Scratching, hitting, jarring, or stressing the glass may weaken its structure causing an increased risk of breakage at a later time.

TROUBLESHOOTING

FAQs

Can I use a rack in my upper oven to reheat or cook on two levels at once?

Only use the rack that is supplied with your upper oven. Use of any other rack can result in poor cooking performance and/or arcing and may damage your oven.

Will the upper oven be damaged if it operates empty?

Yes. Never operate the oven empty or without the glass tray.

Does microwave energy pass through the viewing screen in the door?

No. The metal screen bounces the energy back to the oven cavity. The holes (or ports) allow only light to pass through. They do not let microwave energy pass through.

Why do I see light reflection around the outer case?

This light is from the upper oven light which is located between the oven cavity and the outer wall of the oven.

What are the various sounds I hear when the upper oven is operating?

The clicking sound is caused by a mechanical switch turning the microwave oven's magnetron ON and OFF.

The heavy hum and clunk is from the change in power the magnetron draws as it is turned ON and OFF by a mechanical switch. The change in blower speed is from the change in line voltage caused by the magnetron being turned ON and OFF.

Can my upper oven be damaged if food is cooked for too long?

Like any other cooking appliance, it is possible to overcook food to the point that the food creates smoke and even possibly fire, and damage to the inside of the oven. It is always best to be near the oven while you are cooking.

Why is a standing time recommended after microwave cooking time is over?

Standing time allows foods to continue cooking evenly for a few minutes after the actual microwave oven cooking cycle. The amount of standing time depends upon the density of the foods.

Why is additional time required for cooking food stored in the refrigerator?

As in conventional cooking, the initial temperature of food affects total cooking time. You need more time to cook food taken out of a refrigerator than for food at room temperature.

Can I use either metal or aluminum pans in my upper oven?

Usable metal includes aluminum foil for shielding (use small, flat pieces), and shallow foil trays (if tray is $\frac{3}{4}$ inch deep and filled with food to absorb microwave energy). Never allow metal to touch walls or door.

Sometimes the door of my upper oven appears wavy. Is this normal?

This appearance is normal and does not affect the operation of your oven.

The glass tray does not move.

The glass tray is not correctly in place. It should be correct-side up and sitting firmly on the center hub. The support is not operating correctly. Remove the glass tray and restart the oven. Cooking without the glass tray can give you poor results.

Why does the dish become hot when I microwave food in it? I thought that this should not happen.

As the food becomes hot it will conduct the heat to the dish. Use hot pads to remove food after cooking.

What does standing time mean?

Standing time means that food should be taken out of the oven and covered for additional time after cooking. This process allows the cooking to finish, saves energy, and frees the oven for other purposes.

Can I pop popcorn in my upper oven? How do I get the best results?

Yes. Pop packaged microwave popcorn following manufacturer's guidelines or use the preprogrammed Popcorn key.

Do not use regular paper bags. Use the listening test by stopping the oven as soon as the popping slows to a pop every one or two seconds. Do not try to repop unpopped kernels. You can also use special microwave poppers. When using a popper, be sure to follow manufacturer's directions. Do not pop popcorn in glass utensils.

Why does steam come out of the air exhaust vent?

Steam is normally produced during cooking. The upper oven has been designed to vent steam out of the top vent.

The Lower oven doesn't cook like my old one. Is there something wrong with the temperature settings?

No, your oven has been factory tested and calibrated. For the first few uses, follow your recipe times and temperatures carefully. If you still think your new oven is too hot or too cold, you can adjust the oven temperature yourself to meet your specific cooking needs. Refer to the Oven Temperature Adjustment section in this manual for easy instructions on how to adjust your thermostat.

Is it normal to hear a clicking noise coming from the back of the lower oven when I am using it?

Your new oven is designed to maintain a tighter control over your oven's temperature. You may hear your oven's heating elements click on and off more frequently on your new oven. This is NORMAL.

Why is the time flashing?

This means that the product has just been plugged in, or that it has experienced a power interruption. To clear the flashing time, touch any button and reset the clock if needed.

During convection cooking the fan stops when I open the door. Is that normal?

Yes, this is normal. When the door is opened, the convection fan will stop until the door is closed.

Can I use aluminum foil to catch drippings in the lower oven cavity?

Never use aluminum foil to line the bottom or sides of the oven. The foil will melt and stick to the bottom surface of the oven and will not be removable. Use a sheet pan placed on a lower oven rack to catch drippings instead. (If foil has already melted onto the bottom of the oven, it will not interfere with the oven's performance.)

Can I use aluminum foil on the racks?

Do not cover racks with aluminum foil. Covering entire racks with foil restricts air flow, leading to poor cooking results. Use a sheet pan lined with foil under fruit pies or other acidic or sugary foods to prevent spillovers from damaging the oven finish.



CAUTION

Foil may be used to wrap food in the lower oven, but do not allow the foil to come into contact with the exposed heating/broiling elements in the oven. The foil could melt or ignite, causing smoke, fire, or injury.

Can I leave my racks in the oven when running a Self Clean cycle?

No. Although it will not damage the racks, it will discolor them and may make them hard to slide in and out during use. Remove all items from the oven before starting a Self Clean cycle.

What should I do if my racks are sticky and have become hard to slide in and out?

Over time, the racks may become hard to slide in and out. Apply a small amount of olive oil to the ends of the racks. This will work as a lubricant for easier gliding.

Why aren't the function buttons working?

Make sure that the oven is not in Lockout mode. The lock  will show in the display if Lockout is activated. To deactivate Lockout, touch and hold **Lower Clear/Off** for three seconds. The unlock melody sounds and **Loc** appears in the display until the controls are unlocked.

My oven is still dirty after running the EasyClean® cycle. What else should I do?

The EasyClean® cycle only helps to loosen light soils in your oven to assist in hand-cleaning of your oven. It does not automatically remove all soils after the cycle. Some scrubbing of your oven is required after running the EasyClean® cycle.

I tried scrubbing my oven after running EasyClean®, but some soils still remain. What can I do?

The EasyClean® feature works best when the soils are fully soaked and submerged in water before running the cycle and during hand-cleaning. If soils are not sufficiently soaked in water, it can negatively affect the cleaning performance. Repeat the EasyClean® process using sufficient water. Sugar-based and certain greasy soils are especially hard to clean. If some stubborn soils remain, use the Self Clean feature to thoroughly clean your oven.

Soil on the oven walls is not coming off. How can I clean the oven walls?

Soils on the side and rear walls of your oven may be more difficult to fully soak with water. Try repeating the EasyClean® process with more than the ¼ cup (2 oz or 60 ml).

Will EasyClean® get all of the soils and stains out completely?

It depends on the soil type. Sugar-based and certain grease stains are especially hard to clean. Also, if stains are not sufficiently soaked in water, this can negatively affect cleaning performance. If stubborn or built-up stains remain, use the Self Clean feature. Refer to the Self Clean section of your owner's manual.

Are there any tricks to getting some of the stubborn soils out?

Scraping the soils with a plastic scraper before and during hand-cleaning is recommended. Fully saturating soils with water is also recommended. However, certain types of soils are harder to clean than others. For these stubborn soils, the Self Clean cycle is recommended. Consult the Self Clean section of your owner's manual for details.

Is it safe for my convection fan, broil burner or heater element to get wet during EasyClean®?

Yes. The convection fan, broiler burner or heater element may get a little wet during cleaning. However, direct spray onto the broil burner and heater elements is not necessary because these are self-cleaning during regular use.

I see smoke coming out of my oven's vents during EasyClean®. Is this normal?

This is normal. This is not smoke. It is actually water vapor (steam) from the water in the oven cavity. As the oven heats briefly during EasyClean®, the water in the cavity evaporates and escapes through the oven vents.

How often should I use EasyClean®?

EasyClean® can be performed as often as you wish. EasyClean® works best when your oven is LIGHTLY soiled from such things as LIGHT grease splatter and small drops of cheese. Please refer to the EasyClean® section in your owner's manual for more information.

What is required for EasyClean®?

A plastic scraper, a non-scratch scrubbing pad and a towel. You should not use abrasive scrubbers such as heavy-duty scouring pads or steel wool. Except for a towel, all of the materials you need are included in a special cleaning kit with your new oven.

Before Calling for Service

Before you call for service, review this list. It may save you time and expense. The list includes common occurrences that are not the result of defective workmanship or materials in this appliance.

Symptoms	Possible Causes / Solutions							
Oven control beeps and displays any F code error	<ul style="list-style-type: none"> Electronic control has detected a fault condition. Touch Clear/Off to clear the display and stop beeping. Reprogram oven. If fault recurs, record fault number. Touch Clear/Off and contact a Service agent. 	<table border="1"> <thead> <tr> <th data-bbox="847 311 945 349">CODE</th> <th data-bbox="945 311 1274 349">CAUSE</th> </tr> </thead> <tbody> <tr> <td data-bbox="847 349 945 394">F-3</td> <td data-bbox="945 349 1274 394">Touch key error</td> </tr> <tr> <td data-bbox="847 394 945 465">F-19</td> <td data-bbox="945 394 1274 465">Oven not heating (Lower oven)</td> </tr> </tbody> </table>	CODE	CAUSE	F-3	Touch key error	F-19	Oven not heating (Lower oven)
CODE		CAUSE						
F-3	Touch key error							
F-19	Oven not heating (Lower oven)							
Oven will not work	<ul style="list-style-type: none"> Plug on range is not completely inserted in the electrical outlet. <ul style="list-style-type: none"> Make sure electrical plug is plugged into a live, properly grounded outlet. A fuse in your home may be blown or the circuit breaker tripped. <ul style="list-style-type: none"> Replace the fuse or reset the circuit breaker. Oven controls improperly set. <ul style="list-style-type: none"> See the Using the Oven section. Oven too hot. <ul style="list-style-type: none"> Allow the oven to cool to below locking temperature. 							
Arcing or Sparking (Upper Oven)	<ul style="list-style-type: none"> Cookware is not microwave safe. When in doubt, test cookware before use. Do not operate oven while empty. 							
Unevenly Cooked Foods (Upper Oven)	<ul style="list-style-type: none"> Test cookware to make sure it is microwave safe. Do not cook without the glass tray. Turn or stir food while cooking. Defrost food completely before cooking. Use correct cook time and power level. 							
Overcooked Foods (Upper Oven)	<ul style="list-style-type: none"> Change cook time or power level. 							
Undercooked Foods (Upper Oven)	<ul style="list-style-type: none"> Test that cookware is microwave safe. Defrost food completely before cooking. Change cook time or power level. Make sure ventilation ports are not blocked. 							
Improper Defrosting (Upper Oven)	<ul style="list-style-type: none"> Test that cookware is microwave safe. Change defrost time or weight. Turn or stir food during defrost cycle. 							
If the display shows a time counting down but the oven is not cooking	<ul style="list-style-type: none"> Check that door is firmly closed. Check that timer wasn't started instead of a cooking function. 							
Steam is exhausted through the oven vent	<ul style="list-style-type: none"> Cooking foods with high moisture produces steam. This is normal. 							

Symptoms	Possible Causes / Solutions
Appliance does not operate	<ul style="list-style-type: none"> • Make sure cord is plugged correctly into outlet. Check circuit breakers. • Service wiring is not complete. Contact your electrician for assistance. • Power outage. Check house lights to be sure. Call your local electric company for service.
Oven light does not work	<ul style="list-style-type: none"> • Replace or tighten bulb. See Changing the Oven Light section in this Owner's Manual.
Oven smokes excessively during broiling	<ul style="list-style-type: none"> • Control not set properly. Follow instructions under Setting Oven Controls. • Meat too close to the element. Reposition the rack to provide proper clearance between the meat and the element. Preheat broil element for searing. • Meat not properly prepared. Remove excess fat from meat. Cut remaining fatty edges to prevent curling. • Insert on broiler pan wrong side up and grease not draining. Always place grid on the broiler pan with ribs up and slots down to allow grease to drip into pan. • Grease has built up on oven surfaces. Regular cleaning is necessary when broiling frequently. <ul style="list-style-type: none"> - Old grease or food spatters cause excessive smoking.
Food does not bake or roast properly	<ul style="list-style-type: none"> • Oven controls improperly set. <ul style="list-style-type: none"> - See the Using the Oven section. • Rack position is incorrect or the rack is not level. <ul style="list-style-type: none"> - See the Using the Oven section. • Incorrect cookware or cookware of improper size being used. <ul style="list-style-type: none"> - See the Using the Oven section. • Oven sensor needs to be adjusted. <ul style="list-style-type: none"> - See Oven Temperature Adjustment in the Features section.
Food does not broil properly	<ul style="list-style-type: none"> • Oven controls improperly set. <ul style="list-style-type: none"> - Make sure you touch Broil. • Improper rack position being used. <ul style="list-style-type: none"> - See the Broiling Guide. • Cookware not suited for broiling. <ul style="list-style-type: none"> - Use broiling pan and grid. • Aluminum foil used on the broiling pan and grid has not been fitted properly and slit as recommended. <ul style="list-style-type: none"> - See the Using the Oven section. • In some areas the power voltage may be low. <ul style="list-style-type: none"> - Preheat the broil element for 5-7 minutes. - See the Broiling Guide.
Oven temperature too hot or too cold	<ul style="list-style-type: none"> • Oven sensor needs to be adjusted. <ul style="list-style-type: none"> - See Oven Temperature Adjustment in the Features section.

Symptoms	Possible Causes / Solutions
Oven will not Self Clean	<ul style="list-style-type: none"> • The oven temperature is too high to set a Self Clean operation. <ul style="list-style-type: none"> - Allow the oven to cool and reset the controls. • Oven controls improperly set. <ul style="list-style-type: none"> - See the Self Clean section. • A Self Clean cycle cannot be started if the oven lockout feature is active. • Make sure to slide the tank into the slot until it clicks into place.
“Crackling” or “popping” sound	<ul style="list-style-type: none"> • This is the sound of the metal heating and cooling during both the cooking and Self Clean functions. <ul style="list-style-type: none"> - This is normal.
Fan noise	<ul style="list-style-type: none"> • A convection fan may automatically turn on and off. <ul style="list-style-type: none"> - This is normal.
Convection Fan stops	<ul style="list-style-type: none"> • Convection fan stops during a convection bake cycle. <ul style="list-style-type: none"> - This is normal and is done to allow for more even heating during the cycle. This is not a failure of the oven and should be considered normal operation.
Displayed Time is flashing	<ul style="list-style-type: none"> • This is normal. This means that the product has just been plugged in, or that it has experienced a power interruption. Touch the Clock key and reset the time, or touch any key to stop the flashing.
Excessive smoking during a Self Clean cycle	<ul style="list-style-type: none"> • Excessive soil. <ul style="list-style-type: none"> - Touch the Clear/Off button. Open the windows to rid the room of smoke. Wait until the Self Clean mode is cancelled. Wipe up the excess soil and reset the clean.
Oven door does not open after a Self Clean cycle	<ul style="list-style-type: none"> • Oven is too hot. <ul style="list-style-type: none"> - Allow the oven to cool below locking temperature. • Allow about one hour for the oven to cool after the completion of a Self Clean cycle. The door can be opened when the lock  is no longer displayed. • The control and door may be locked.
The oven does not clean after a Self Clean cycle	<ul style="list-style-type: none"> • Oven controls not properly set. <ul style="list-style-type: none"> - See the Self Clean section. • Oven was heavily soiled. <ul style="list-style-type: none"> - Clean up heavy spillovers before starting the clean cycle. Heavily soiled ovens may need to Self Clean again or for a longer period of time.
CLEAN and door flash in the display	<ul style="list-style-type: none"> • The Self Clean cycle has been selected, but the door is not closed. <ul style="list-style-type: none"> - Close the oven door.
LOCKED is on in the display when you want to cook	<ul style="list-style-type: none"> • The oven door is locked because the temperature inside the oven has not dropped below the locking temperature. <ul style="list-style-type: none"> - Touch the Clear/Off button. Allow the oven to cool.
Burning or oily odor emitting from the vent	<ul style="list-style-type: none"> • This is normal in a new oven and will disappear in time. <ul style="list-style-type: none"> - To speed the process, set a Self Clean cycle for a minimum of 3 hours. See the Self Clean section.
Oven racks are difficult to slide	<ul style="list-style-type: none"> • The shiny, silver-colored racks were cleaned in a Self Clean cycle. <ul style="list-style-type: none"> - Apply a small amount of vegetable oil to a paper towel and wipe the edges of the oven racks with the paper towel.

Symptoms	Possible Causes / Solutions
Moisture collects on oven window or steam comes from oven vent	<ul style="list-style-type: none"> • This is normal when cooking foods high in moisture. • Excessive moisture was used when cleaning the window.
Oven will not Steam cook	<ul style="list-style-type: none"> • Make sure to slide the tank into the slot until it clicks into place. • The drain in the steam feeder tank may be clogged with hard water scale. If this happens, the descaling function must be run before the steam function can be used.
Water pools in the bottom of the oven during or after steam cooking	<ul style="list-style-type: none"> • During steam cooking, the water in the steam feeder is transferred to the bottom of the oven. It is normal for water to fill the bottom of the oven during or after the Steam mode. • If the water leaves mineral deposits on the oven bottom, remove the deposits with a cloth or sponge soaked in vinegar.
White residue appears on the oven bottom after steam cooking	<ul style="list-style-type: none"> • Using hard water in the steam feeder can result in hard water scale on the oven bottom. • To remove mineral deposits that remain on the oven bottom, use a cloth or sponge soaked in vinegar or a weak citric acid solution.
Trouble connecting appliance and smartphone to Wi-Fi network	<ul style="list-style-type: none"> • The password for the Wi-Fi network was entered incorrectly. <ul style="list-style-type: none"> - Delete your home Wi-Fi network and begin the registration process again. • Mobile data for your smartphone is turned on. <ul style="list-style-type: none"> - Turn off the Mobile data on your smartphone before registering the appliance. • The wireless network name (SSID) is set incorrectly. <ul style="list-style-type: none"> - The wireless network name (SSID) should be a combination of English letters and numbers. (Do not use special characters.) • The router frequency is not 2.4 GHz. <ul style="list-style-type: none"> - Only a 2.4 GHz router frequency is supported. Set the wireless router to 2.4 GHz and connect the appliance to the wireless router. To check the router frequency, check with your Internet service provider or the router manufacturer. • The distance between the appliance and the router is too far. <ul style="list-style-type: none"> - If the appliance is too far from the router, the signal may be weak and the connection may not be configured correctly. Move the router closer to the appliance or purchase and install a Wi-Fi repeater.

LIMITED WARRANTY (USA)

ARBITRATION NOTICE: THIS LIMITED WARRANTY CONTAINS AN ARBITRATION PROVISION THAT REQUIRES YOU AND LG TO RESOLVE DISPUTES BY BINDING ARBITRATION INSTEAD OF IN COURT, UNLESS YOU CHOOSE TO OPT OUT. IN ARBITRATION, CLASS ACTIONS AND JURY TRIALS ARE NOT PERMITTED. PLEASE SEE THE SECTION TITLED "PROCEDURE FOR RESOLVING DISPUTES" BELOW.

Should your LG Electric Oven ("Product") fail due to a defect in materials or workmanship under normal and proper use, during the warranty period set forth below, LG Electronics ("LG") will, at its option, repair or replace the Product. This limited warranty is valid only to the original retail purchaser of the Product and applies only when purchased and used within the United States including U.S. Territories.

Warranty Period	Scope of Warranty	HOW SERVICE IS HANDLED
One (1) year from date of original retail purchase	Parts and Labor (internal / functional parts only)	LG will provide, free of charge, all labor and in-home service to replace defective part(s).
Five (5) years from the date of original retail purchase	Magnetron Only	
Ten (10) years from the date of original retail purchase	Inverter Magnetron Only	

- Replacement products and parts are warranted for the remaining portion of the original warranty period or ninety (90) days, whichever is greater.
- Replacement products and parts may be new, reconditioned, refurbished, or otherwise factory remanufactured.
- Proof of original retail purchase specifying the Product model and date of purchase is required to obtain warranty service under this limited warranty.

EXCEPT TO THE EXTENT PROHIBITED BY APPLICABLE LAW, ANY IMPLIED WARRANTY OF MERCHANTABILITY OR FITNESS FOR A PARTICULAR PURPOSE ON THE PRODUCT IS LIMITED IN DURATION TO THE DURATION OF THE ABOVE LIMITED WARRANTY. UNDER NO CIRCUMSTANCES SHALL LG OR ITS U.S. DISTRIBUTORS/DEALERS BE LIABLE FOR ANY INDIRECT, INCIDENTAL, CONSEQUENTIAL, SPECIAL, OR PUNITIVE DAMAGES, INCLUDING, WITHOUT LIMITATION, LOST GOODWILL, LOST REVENUES OR PROFITS, WORK STOPPAGE, IMPAIRMENT OF OTHER GOODS, COST OF REMOVAL AND REINSTALLATION OF THE PRODUCT, LOSS OF USE, OR ANY OTHER DAMAGES WHETHER BASED IN CONTRACT, TORT, OR OTHERWISE. LG'S TOTAL LIABILITY, IF ANY, SHALL NOT EXCEED THE PURCHASE PRICE PAID BY YOU FOR THE PRODUCT.

Some states do not allow the exclusion or limitation of incidental or consequential damages or limitations on how long an implied warranty lasts, so the above exclusions or limitations may not apply to you. This limited warranty gives you specific legal rights and you may also have other rights that vary from state to state.

THIS LIMITED WARRANTY DOES NOT COVER:

- Service trips to deliver, pick up, or install, educate how to operate, correct wiring, or correct unauthorized repairs.
- Damage or failure of the Product to perform during power failures and interrupted or inadequate electrical service.
- Damage or failure resulting from operating the Product in a corrosive atmosphere or contrary to the Product owner's manual.
- Damage or failure to the Product caused by accidents, pests and vermin, lightning, wind, fire, floods, acts of God, or any other causes beyond the control of LG.
- Damage or failure caused by unauthorized modification or alteration, or if used for other than the intended purpose.
- Damage or failure resulting from misuse, abuse, improper installation, repair, or maintenance. Improper repair includes use of parts not authorized by LG. Improper installation or maintenance includes installation or maintenance contrary to the Product owner's manual.
- Damage or failure caused by incorrect electrical current, voltage, or ventilation/plumbing codes.

- Damage or failure caused by transportation and handling, including scratches, dents, chips, and/or other damage to the finish of the Product, unless such damage is reported within one (1) week of delivery.
- Damage or missing items to any display, open box, or discounted Product.
- Refurbished Product or any Product sold “As Is”, “Where Is”, “With all Faults”, or similar disclaimer.
- Products with original serial numbers that have been removed, altered, or cannot be readily determined.
- Increases in utility costs and additional utility expenses.
- Any noises associated with normal operation.
- Use of accessories, components, or consumable cleaning products that are not authorized by LG.
- Replacement of light bulbs, filters, or any consumable parts.
- When Product is used for other than normal and proper household use (e.g. commercial or industrial use, offices, and recreational facilities or vehicles) or contrary to the Product’s owner’s manual.
- Costs associated with removal and reinstallation of your Product for repairs.
- Shelves, drawers and accessories, except for internal/functional parts covered under this limited warranty.

Not Covered by this Limited Warranty

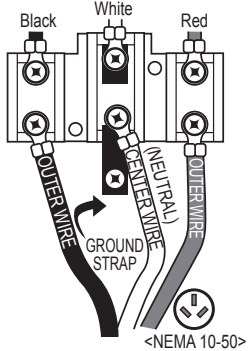
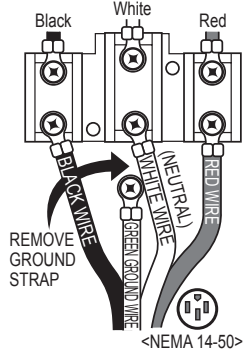
Problem	Cause	Prevention
<ul style="list-style-type: none"> • Spark / Arcing 	Aluminum foil or metal utensil used in microwave mode.	<ul style="list-style-type: none"> • DO NOT use aluminum foil or metal utensils in microwave mode. - Check user instructions
<ul style="list-style-type: none"> • Unit has no power 	<ol style="list-style-type: none"> 1. House power turned off (power supply) 2. Tripped breaker 3. The power cord is not installed properly 	<ol style="list-style-type: none"> 1. Check house power supply 2. Check proper power cord connection 3. Check extension cord
<ul style="list-style-type: none"> • Oven or racks are stained after using aluminum foil 	Aluminum foil has melted in the oven 	<ul style="list-style-type: none"> • Never cover the oven bottom or cover an entire rack with materials such as aluminum foil. • If the foil has already melted onto the oven, it will not affect the performance of the oven.
<ul style="list-style-type: none"> • Unit has no power 	<ol style="list-style-type: none"> 1. House power turned off (power supply) 2. Tripped breaker 3. The power cord is not installed properly. <div style="display: flex; justify-content: space-around;"> <div data-bbox="395 1367 642 1754"> <p>3-WIRE HOOK UP</p>  </div> <div data-bbox="655 1367 902 1754"> <p>4-WIRE HOOK UP</p>  </div> </div>	<ul style="list-style-type: none"> • Check power at main board before calling for service. • Match power cord type and outlet type

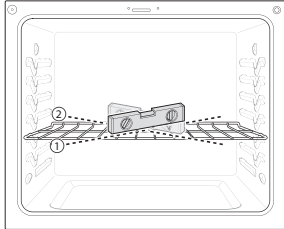
Problem	Cause	Prevention
<ul style="list-style-type: none"> • Surface is not level • Oven is tipping 	<p>Oven not leveled</p>  <p>Use carpenter's level to check level.</p>	<ul style="list-style-type: none"> • Check with installer first

The cost of repair or replacement under the above excluded circumstances shall be borne by the consumer.

TO OBTAIN WARRANTY SERVICE AND ADDITIONAL INFORMATION

Call 1-800-243-0000 and select the appropriate option from the menu.

Or visit our website at <http://www.lg.com>

Or by mail: LG Electronics Customer Service P.O. Box 240007 Huntsville, AL 35813 ATTN: CIC

PROCEDURE FOR RESOLVING DISPUTES:

ALL DISPUTES BETWEEN YOU AND LG ARISING OUT OF OR RELATING IN ANY WAY TO THIS LIMITED WARRANTY OR THE PRODUCT SHALL BE RESOLVED EXCLUSIVELY THROUGH BINDING ARBITRATION, AND NOT IN A COURT OF GENERAL JURISDICTION. BINDING ARBITRATION MEANS THAT YOU AND LG ARE EACH WAIVING THE RIGHT TO A JURY TRIAL AND TO BRING OR PARTICIPATE IN A CLASS ACTION.

Definitions. For the purposes of this section, references to "LG" mean LG Electronics U.S.A., Inc., its parents, subsidiaries and affiliates, and each of their officers, directors, employees, agents, beneficiaries, predecessors in interest, successors, assigns and suppliers; references to "dispute" or "claim" shall include any dispute, claim or controversy of any kind whatsoever (whether based in contract, tort, statute, regulation, ordinance, fraud, misrepresentation or any other legal or equitable theory) arising out of or relating in any way to the sale, condition or performance of the product or this Limited Warranty.

Notice of Dispute. In the event you intend to commence an arbitration proceeding, you must first notify LG in writing at least 30 days in advance of initiating the arbitration by sending a letter to LG at LG Electronics, USA, Inc. Attn: Legal Department- Arbitration 1000 Sylvan Ave, Englewood Cliffs 07632. You and LG agree to engage in good faith discussions in an attempt to amicably resolve your claim. The notice must provide your name, address, and telephone number; identify the product that is the subject of the claim; and describe the nature of the claim and the relief being sought. If you and LG are unable to resolve the dispute within 30 days, either party may proceed to file a claim for arbitration.

Agreement to Binding Arbitration and Class Action Waiver. Upon failure to resolve the dispute during the 30 day period after sending written notice to LG, you and LG agree to resolve any claims between us only by binding arbitration on an individual basis, unless you opt out as provided below. Any dispute between you and LG shall not be combined or consolidated with a dispute involving any other person's or entity's product or claim. More specifically, without limitation of the foregoing, any dispute between you and LG shall not under any circumstances proceed as part of a class or representative action. Instead of arbitration, either party may bring an individual action in small claims court, but that small claims court action may not be brought on a class or representative basis.

Arbitration Rules and Procedures. To begin arbitration of a claim, either you or LG must make a written demand for arbitration. The arbitration will be administered by the American Arbitration Association (“AAA”) and will be conducted before a single arbitrator under the AAA’s Consumer Arbitration Rules that are in effect at the time the arbitration is initiated (referred to as the “AAA Rules”) and under the procedures set forth in this section. The AAA Rules are available online at www.adr.org/consumer. Send a copy of your written demand for arbitration, as well as a copy of this provision, to the AAA in the manner described in the AAA Rules. You must also send a copy of your written demand to LG at LG Electronics, USA, Inc. Attn: Legal Department- Arbitration 1000 Sylvan Avenue Englewood Cliffs, NJ 07632. If there is a conflict between the AAA Rules and the rules set forth in this section, the rules set forth in this section will govern. This arbitration provision is governed by the Federal Arbitration Act. Judgment may be entered on the arbitrator’s award in any court of competent jurisdiction. All issues are for the arbitrator to decide, except that issues relating to the scope and enforceability of the arbitration provision and to the arbitrability of the dispute are for the court to decide. The arbitrator is bound by the terms of this provision.

Governing Law. The law of the state of your residence shall govern this Limited Warranty and any disputes between us except to the extent that such law is preempted by or inconsistent with applicable federal law.

Fees/Costs. You do not need to pay any fee to begin an arbitration. Upon receipt of your written demand for arbitration, LG will promptly pay all arbitration filing fees to the AAA unless you seek more than \$25,000 in damages, in which case the payment of these fees will be governed by the AAA Rules. Except as otherwise provided for herein, LG will pay all AAA filing, administration and arbitrator fees for any arbitration initiated in accordance with the AAA Rules and this arbitration provision. If you prevail in the arbitration, LG will pay your attorneys’ fees and expenses as long as they are reasonable, by considering factors including, but not limited to, the purchase amount and claim amount. Notwithstanding the foregoing, if applicable law allows for an award of reasonable attorneys’ fees and expenses, an arbitrator can award them to the same extent that a court would. If the arbitrator finds either the substance of your claim or the relief sought in the demand is frivolous or brought for an improper purpose (as measured by the standards set forth in Federal Rule of Civil Procedure 11(b)), then the payment of all arbitration fees will be governed by the AAA Rules. In such a situation, you agree to reimburse LG for all monies previously disbursed by it that are otherwise your obligation to pay under the AAA Rules. Except as otherwise provided for, LG waives any rights it may have to seek attorneys’ fees and expenses from you if LG prevails in the arbitration.

Hearings and Location. If your claim is for \$25,000 or less, you may choose to have the arbitration conducted solely on the basis of (1) documents submitted to the arbitrator, (2) through a telephonic hearing, or (3) by an in-person hearing as established by the AAA Rules. If your claim exceeds \$25,000, the right to a hearing will be determined by the AAA Rules. Any in-person arbitration hearings will be held at a location within the federal judicial district in which you reside unless we both agree to another location or we agree to a telephonic arbitration.

Opt Out. You may opt out of this dispute resolution procedure. If you opt out, neither you nor LG can require the other to participate in an arbitration proceeding. To opt out, you must send notice to LG no later than 30 calendar days from the date of the first consumer purchaser’s purchase of the product by either: (i) sending an e-mail to optout@lge.com, with the subject line: “Arbitration Opt Out” or (ii) calling 1-800-980-2973. You must include in the opt out e-mail or provide by telephone: (a) your name and address; (b) the date on which the product was purchased; (c) the product model name or model number; and (d) the serial number (the serial number can be found (i) on the product; or (ii) online by accessing <https://www.lg.com/us/support/repair-service/schedule-repair-continued> and clicking on “Find My Model & Serial Number”).

You may only opt out of the dispute resolution procedure in the manner described above (that is, by e-mail or telephone); no other form of notice will be effective to opt out of this dispute resolution procedure. Opting out of this dispute resolution procedure will not affect the coverage of the Limited Warranty in any way, and you will continue to enjoy the full benefits of the Limited Warranty. If you keep this product and do not opt out, then you accept all terms and conditions of the arbitration provision described above.