

Installation

SCREW (TYPE A) 14 EA 	SCREW (TYPE B) 3 EA 	SCREW (TYPE C) 5 EA 	SILL SUPPORT 2 EA
BOLT 2 EA 	NUT 2 EA 	FRAME CURTAIN 2 EA 	
FOAM-STRIP (Not adhesive backed) 1 EA 	DRAIN PIPE 1 EA 	Left Guide Panel 	
FRAME GUIDE 2 EA 	WINDOW LOCKING BRACKET 1 EA 	Right Guide Panel 	Curtain
FRAME GUIDE 2 EA 	WINDOW LOCKING BRACKET 1 EA 	FOAM-PE (Adhesive backed) 6EA 	FOAM-HEATPROOF (Adhesive backed) 2 EA

Have the following tools available for installation:

* Phillips head
screwdriver

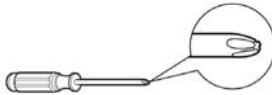

* Ruler

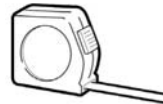

* Scissors or
knife



* Level



* Pencil



* Adjustable
Wrench



How to Install the Unit

- 1 To prevent vibration and noise, make sure the unit is installed securely and firmly
- 2 Install the unit where the sunlight does not shine directly on the unit.
- 3 The outside of the cabinet must extend outward for at least 12" and there should be no obstacles, such as a fence or wall, within 20" from the back of the cabinet because it will prevent heat radiation of the condenser.
Restriction of outside air will greatly reduce the cooling efficiency of the air conditioner.

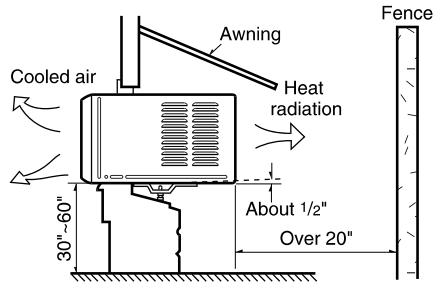

CAUTION: All side louvers of the cabinet must remain exposed to the outside of the structure.

- 4 Install the unit slightly tilted so the back is slightly lower than the front (about 1/2"). This will force condensed water to flow to the outside.
- 5 Install the unit with the bottom between 30"-60" above the floor level.

Window Requirements

NOTICE : All supporting parts should be secured to firm wood, masonry, or metal.

- This unit is designed for installation in standard double hung windows with actual opening widths from 27" to 39".
- The top and bottom window sash must open sufficiently to allow a clear vertical opening of 16" from the bottom of the upper sash to the window stool.

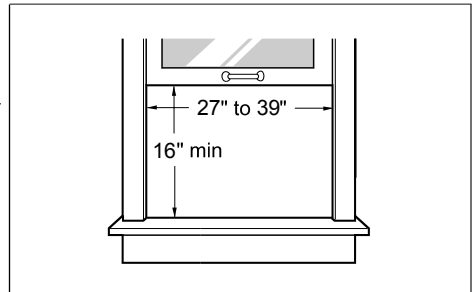

Preparation Of Chassis

- 1 Remove 4 screws which fasten the cabinet at both sides and at the back. (Keep the screws for later use.)

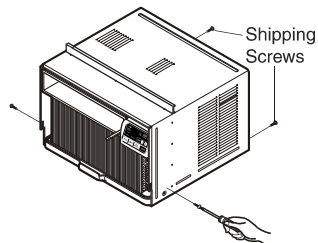

- Slide the unit from the cabinet by gripping the base pan handle and pulling forward while bracing the cabinet.

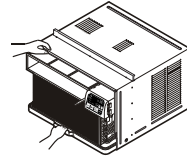

- Cut the window sash seals to the proper length. Peel off the backing and attach the Foam-PE (Adhesive backed) to the underside of the window sash and bottom of window frame.

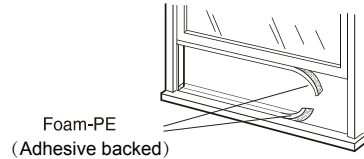

- Insert the frame guides into the bottom of the cabinet.

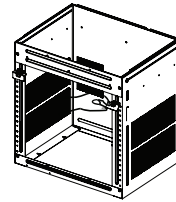

- Insert the frame curtain into the upper guide and frame guides.
- Fasten the curtains to the unit with 8 Type A screws.

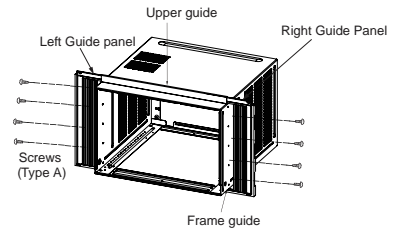

Cabinet Installation

- Open the window. Mark a line on center of the window stool. Carefully place the cabinet on the window stool and align the center hole on the bottom front with the center line marked in the window stool.
- Pull the bottom window sash down behind the upper guide until it meets.

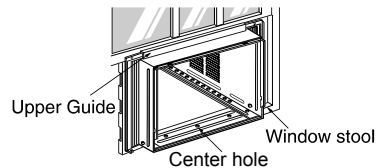

NOTICE Do not pull the window sash down tightly that the movement of frame curtain is restricted.

- Loosely assemble the sill support.

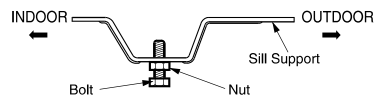

- 4 Select the position that will place the Sill Support near the outermost point on sill

NOTICE Be careful when you install the cabinet (frame guides are broken easily).

- 5 Attach the sill support to the cabinet track hole in relation to the selected position using 2 Type A screws in each support
- 6 The cabinet should be installed with a very slight tilt (about 1/2") downward toward the outside

Adjust the bolt and the nut of sill support for balancing the cabinet.

- 7 Attach the cabinet to the window stool by driving the screws (Type B) through the front angle into window stool.

- 8 Pull each frame curtain fully to each window sash track.

- 9 Attach each frame curtain the window sash using screws (Type C).

CAUTION: Do not drill a hole in the bottom pan. The unit is designed to operate with approximately 1/2" of water in bottom pan. There is no need to add water if the pan is dry.

- 10 Slide the unit into the cabinet.

CAUTION: For security purpose, reinstall screws (removed from the cabinet) at cabinet's sides. See page 12.

- 11 Cut the Foam-Strip (Not adhesive backed) to the proper length and insert between the upper window sash and the lower window sash.

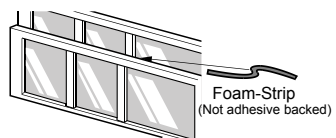
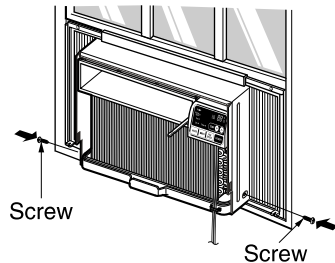
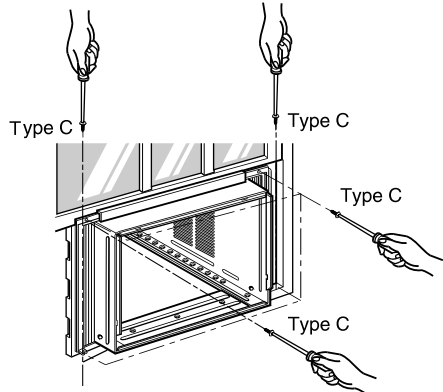
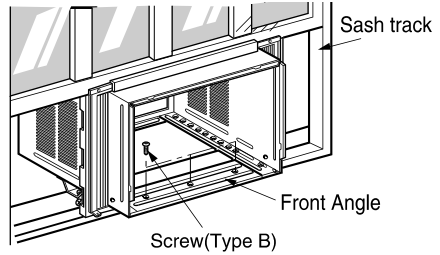
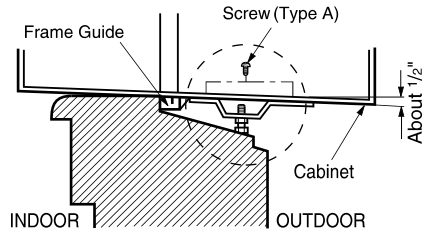

- 12 Attach the window locking bracket with a Type C screw .

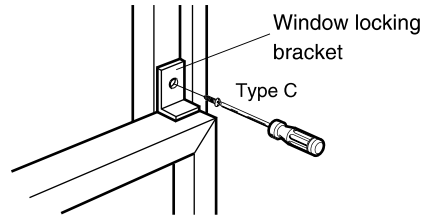

- 13 Before installing the front grille, pull out the vent control lever located above the unit control knobs, as shown.

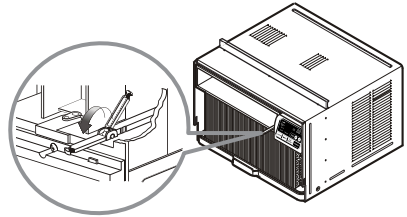

- 14 Cut the adhesive-backed Foam-Heatproofs to the Guide Panel size. Remove the backing from the Foam-Heatproofs and attach the Foam-Heatproofs to Guide Panel.

Tip! Foam-Heatproof improves the cooling capability of the unit.

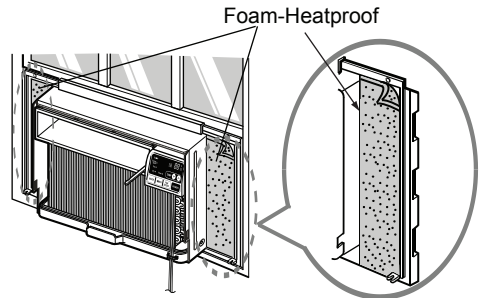

- 15 Attach the front grille to the cabinet by inserting the tabs the grille into the slots on the front the cabinet. Push the grille in until it snaps into place.

NOTICE Guide the lever carefully through the grille as you push it in.

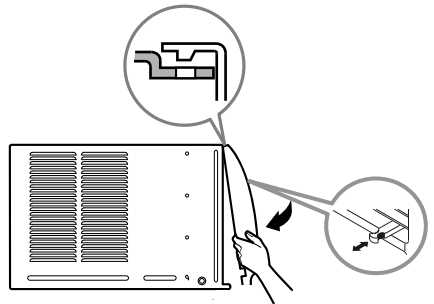

- 16 Take out the air filter and secure it with 2 Type A screws through the front grille.

NOTICE These 2 Type A screws are packaged by bag.

Window installation of room air conditioner is now completed. See ELECTRICAL DATA for attaching power cord to electrical outlet.

