

Kramer Electronics, Ltd.



USER MANUAL

Models:

PT-571HDCP DVI Line Transmitter

PT-572HDCP+ DVI Line Receiver

Contents

1	Introduction	1
2	Getting Started	1
2.1	Quick Start	2
3	Overview	2
3.1	Summarizing the DVI Line Transmitter/Receiver System	3
3.2	About the Power Connect™ Feature	3
3.3	Using Twisted Pair Cable	4
3.4	About HDCP	4
3.5	Achieving the Best Performance	4
4	Your PT-571HDCP/PT-572HDCP+	5
4.1	Your PT-571HDCP DVI Line Transmitter	5
4.2	Your PT-572HDCP+ DVI Line Receiver	6
5	Connecting the PT-571HDCP and PT-572HDCP+	7
5.1	Wiring the CAT 5 LINE IN/LINE OUT RJ-45 Connectors	8
6	Technical Specifications	8

Figures

Figure 1:	PT-571HDCP DVI Line Transmitter	5
Figure 2:	PT-572HDCP+ DVI Line Receiver	6
Figure 3:	Connecting the PT-571HDCP/PT-572HDCP+ DVI Line Transmitter/Receiver	7
Figure 4:	CAT 5 PINOUT	8

Tables

Table 1:	PT-571HDCP DVI Line Transmitter Features	5
Table 2:	PT-572HDCP+ DVI Line Receiver Features	6
Table 3:	CAT 5 PINOUT	8
Table 4:	Technical Specifications	8

1 Introduction

Welcome to Kramer Electronics! Since 1981, Kramer Electronics has been providing a world of unique, creative, and affordable solutions to the vast range of problems that confront the video, audio, presentation, and broadcasting professional on a daily basis. In recent years, we have redesigned and upgraded most of our line, making the best even better! Our 1,000-plus different models now appear in 11 groups¹ that are clearly defined by function.

Thank you for purchasing the Kramer PicoTOOLS™ **PT-571HDCP DVI Line Transmitter** and the **PT-572HDCP+ DVI Line Receiver**, which are ideal for²:

- Board, conference, and training rooms
- Presentation systems
- Signal distribution and home theater

Each package includes the following items:

- **PT-571HDCP DVI Line Transmitter** or **PT-572HDCP+ DVI Line Receiver**
- Power adapter (12V DC Input) and this user manual³

2 Getting Started

We recommend that you:

- Unpack the equipment carefully and save the original box and packaging materials for possible future shipment
- Review the contents of this user manual
- Use Kramer high-performance high-resolution cables⁴

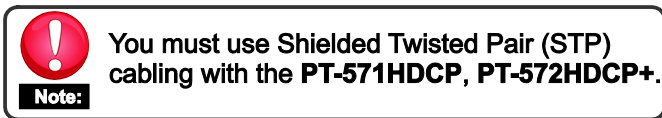

1 GROUP 1: Distribution Amplifiers; GROUP 2: Switchers and Matrix Switchers; GROUP 3: Control Systems; GROUP 4: Format/Standards Converters; GROUP 5: Range Extenders and Repeaters; GROUP 6: Specialty AV Products; GROUP 7: Scan Converters and Scalers; GROUP 8: Cables and Connectors; GROUP 9: Room Connectivity; GROUP 10: Accessories and Rack Adapters; GROUP 11: Sierra Products

2 Ultra-Compact PicoTOOLS™ - 4 units can be rack mounted side-by-side in a 1U rack space with the optional RK-4PT rack adapter

3 Download up-to-date Kramer user manuals from our Web site at <http://www.kramerelectronics.com>

4 The complete list of Kramer cables is on our Web site at <http://www.kramerelectronics.com>

2.1 Quick Start

This quick start chart summarizes the basic setup and operation steps.

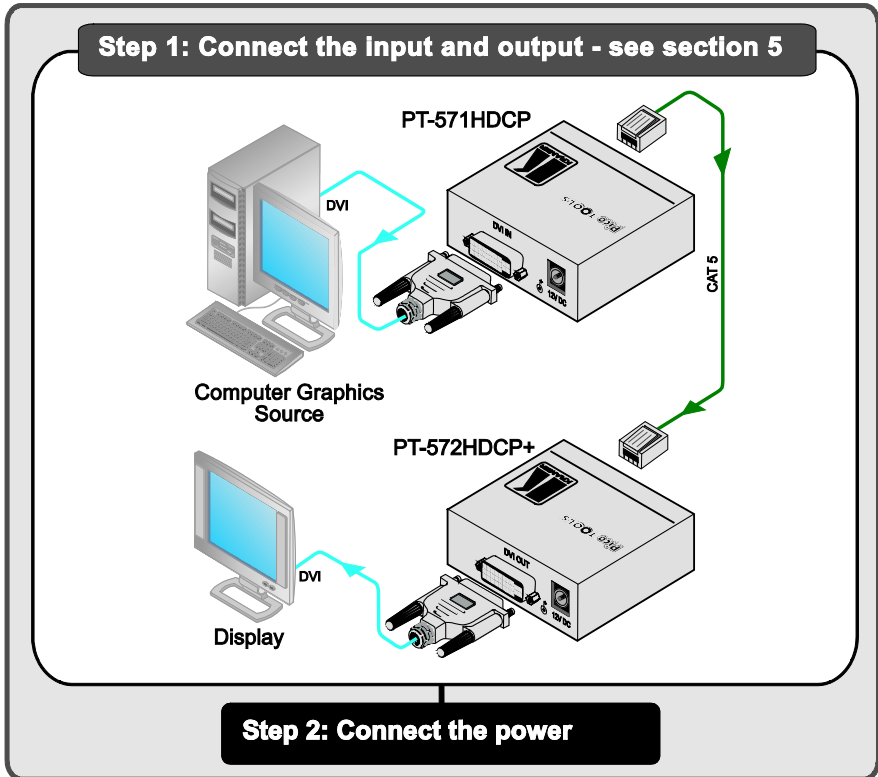

3 Overview

This section summarizes:

- The *DVI Line Transmitter/Receiver System*¹, see section [3.1](#)
- The power connect feature, see section [3.2](#)
- Using Twisted Pair Cable, see section [3.3](#)
- The HDCP standard, see section [3.4](#)
- Recommendations for achieving the best performance, see section [3.5](#)

¹ For details of the PT-571HDCP DVI Line Transmitter and PT-572HDCP+ DVI Line Receiver, see sections [4.1](#) and [4.2](#), respectively

3.1 Summarizing the DVI Line Transmitter/Receiver System

Using the **PT-571HDCP** *DVI Line Transmitter* with the **PT-572HDCP+** *DVI Line Receiver* constitutes a DVI-to-twisted pair transmitter and receiver system. The *DVI Line Transmitter/Receiver* system features:

- Maximum data rate/bandwidth up to 1.65Gbps
- HDTV compatibility and HDCP compliance
- EDID PassThru that passes EDID/HDCP signals from source to display
- System Range¹ - Up to 90m (295ft) at 1080i, or up to 30m (98ft) at 1080p on shielded **BC-DGKat524** cable; 90m (295ft) at 1080i, or up to 70m (230ft) at 1080p on shielded **BC-DGKat623** cable; 100m (330ft) at 1080i or up to 90m (295ft) at 1080p on shielded **BC-DGKat7a23** cable
- Power Connect™ that feeds 12V DC over the CAT 5 cable from transmitter to receiver (see section [3.2](#))
- Two DVI-I connectors, that are compatible with all types of DVI cables

Note that only the digital signal (DVI D) is available on the DVI connector.

3.2 About the Power Connect™ Feature

The Power Connect™ feature here means that only one unit in a system, the transmitter or receiver, can be connected to a power source when the devices are within 270 feet (90 meters) of each other. The Power Connect™ feature applies as long as the cable can carry power. The distance does not exceed 90 meters on standard CAT 5 cable, for longer distances, heavy gauge cable should be used².

¹ Note that the transmission range depends on the signal resolution, graphics card and display used. The distance using non-Kramer CAT 5, CAT 6 and CAT 7a cables may not reach these ranges

² CAT 5 cable is still suitable for the video/audio transmission, but not for feeding the power at these distances

3.3 Using Twisted Pair Cable

Kramer engineers have developed special twisted pair cables to best match our digital twisted pair products; the Kramer: **BC-DGKat524** (CAT 5 24 AWG), the Kramer: **BC-DGKat623** (CAT 6 23 AWG cable), and the Kramer: **BC-DGKat7a23** (CAT 7a 23 AWG cable). These specially built cables significantly outperform regular CAT 5/CAT 6/CAT 7a cables.

3.4 About HDCP

The High-Bandwidth Digital Content Protection (HDCP) standard¹, protects digital video and audio signals transmitted over DVI or HDMI connections between two HDCP-enabled devices to eliminate the reproduction of copyrighted material. To protect copyright holders (such as movie studios) from having their programs copied and shared, the HDCP standard provides for the secure and encrypted transmission of digital signals.

3.5 Achieving the Best Performance

To achieve the best performance:

- Use only good quality connection cables² to avoid interference, deterioration in signal quality due to poor matching, and elevated noise levels (often associated with low quality cables).
- Avoid interference from neighboring electrical appliances that may adversely influence signal quality and position your Kramer devices away from moisture, excessive sunlight and dust

	Caution: No operator serviceable parts inside unit
	Warning: Use only the Kramer Electronics input power wall adapter that is provided with the unit
	Warning: Disconnect power and unplug unit from wall before installing or removing the device or servicing unit

¹ Developed by Intel

² Available from Kramer Electronics on our Web site at <http://www.kramerelectronics.com>

4 Your PT-571HDCP/PT-572HDCP+

This section describes the:

- **PT-571HDCP DVI Line Transmitter**, see section [4.1](#)
- **PT-572HDCP+ DVI Line Receiver**, see section [4.2](#)

4.1 Your PT-571HDCP DVI Line Transmitter

The **PT-571HDCP DVI Line Transmitter** receives a DVI signal, encodes it, and transmits it over a CAT 5 cable to the **PT-572HDCP+**. The **PT-571HDCP** has:

- A DVI input connector
- An RJ-45 CAT 5 output connector
- One power status LED

[Figure 1](#) and [Table 1](#) define the **PT-571HDCP**:

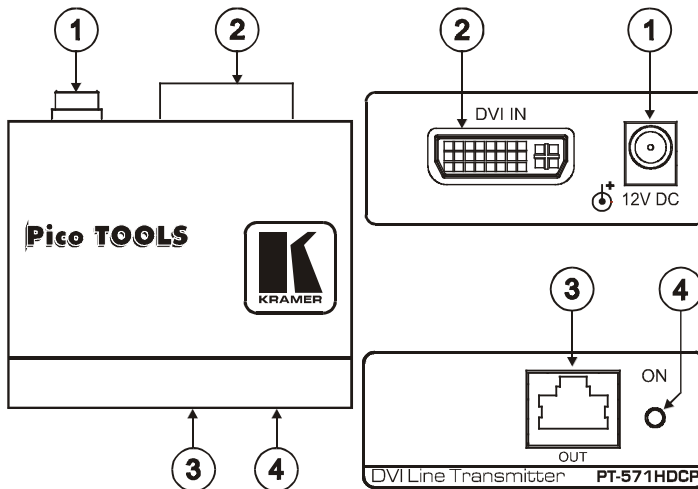

Figure 1: PT-571HDCP DVI Line Transmitter

Table 1: PT-571HDCP DVI Line Transmitter Features

#	Feature	Function
1	12V DC	+12V DC connector for powering the unit
2	DVI IN Connector	Connect to the DVI source
3	OUT RJ-45 Connector	Connect to the IN RJ-45 connector on the PT-572HDCP+
4	ON LED	Lights only when the machine is powered (whether directly from the power adapter or via the PT-572HDCP+) and an input ¹ is connected

¹ Note, if no input is connected the unit invokes the power save mode automatically turning off the power

4.2 Your PT-572HDCP+ DVI Line Receiver

The **PT-572HDCP+ DVI Line Receiver** receives an encoded signal over a CAT 5 cable transmitted from the **PT-571HDCP**, decodes it, and converts it to a DVI output.

The **PT-572HDCP+** has:

- A DVI output connector
- An RJ-45 CAT 5 input connector
- One power status LED

[Figure 2](#) and [Table 2](#) define the **PT-572HDCP+**:

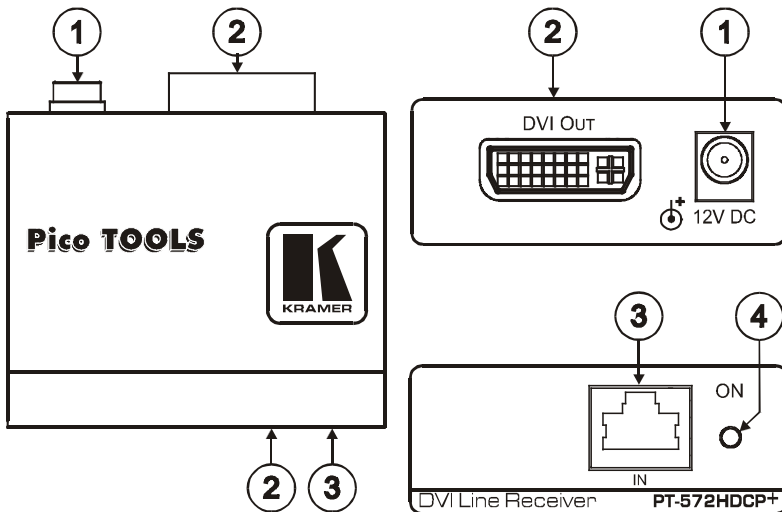

Figure 2: PT-572HDCP+ DVI Line Receiver

Table 2: PT-572HDCP+ DVI Line Receiver Features

#	Feature	Function
1	12V DC	+12V DC connector for powering the unit
2	DVI OUT Connector	Connect to the DVI acceptor
3	IN RJ-45 Connector	Connect to the OUT RJ-45 connector on the PT-571HDCP
4	ON LED	Lights red when receiving power only, orange when output and power are attached, and yellow when both an active input and output are attached

5 Connecting the PT-571HDCP and PT-572HDCP+

You can use the **PT-571HDCP DVI Line Transmitter** with the **PT-572HDCP+ DVI Line Receiver** to configure a DVI transmitter/receiver system.

To connect the **PT-571HDCP** to the **PT-572HDCP+**, as illustrated in the example in [Figure 3](#), do the following:

1. Connect the CAT 5 OUT RJ-45 connector on the **PT-571HDCP** to the CAT 5 IN RJ-45 connector on the **PT-572HDCP+** via a CAT 5 cable (see section [5.1](#)).
2. On the **PT-571HDCP**, connect a DVI source (for example, a computer graphics source) to the DVI IN connector.
3. On the **PT-572HDCP+**, connect the DVI OUT connector to a DVI acceptor (for example, a display).
4. Connect the 12V DC power adapter to the power socket on the **PT-571HDCP** or the **PT-572 HDCP +** and connect the adapter to the mains electricity (not shown in [Figure 3](#)).

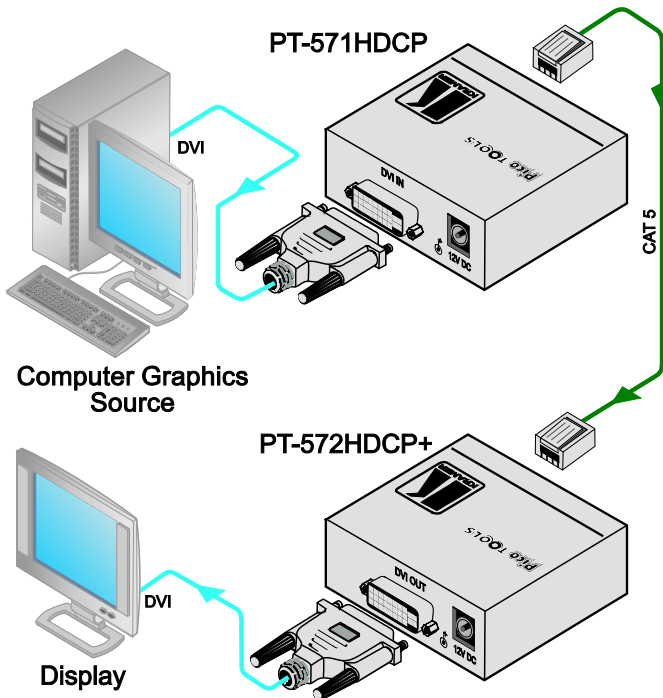

Figure 3: Connecting the PT-571HDCP/PT-572HDCP+ DVI Line Transmitter/Receiver

5.1 Wiring the CAT 5 LINE IN/LINE OUT RJ-45 Connectors

[Table 3](#) and [Figure 4](#) define the CAT 5 pinout, using a straight pin-to-pin cable with RJ-45 connectors (**note, that the cable Ground shielding must be connected/soldered to the connector shield**):

Table 3: CAT 5 PINOUT

EIA /TIA 568A		EIA /TIA 568B	
PIN	Wire Color	PIN	Wire Color
1	Green/White	1	Orange/White
2	Green	2	Orange
3	Orange/White	3	Green/White
4	Blue	4	Blue
5	Blue/White	5	Blue/White
6	Orange	6	Green
7	Brown/White	7	Brown/White
8	Brown	8	Brown
Pair 1		4 and 5	
Pair 2		3 and 6	
Pair 3		1 and 2	
Pair 4		7 and 8	

Figure 4: CAT 5 PINOUT

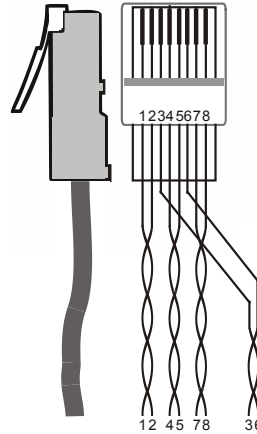

6 Technical Specifications

The **PT-571HDCP/PT-572HDCP+** technical specifications are shown in [Table 4](#).

Table 4: Technical Specifications¹

	PT-571HDCP	PT-572HDCP+
INPUTS:	1 DVI, 1.2Vpp on a DVI Molex 24pin female connector; DDC signal 5Vpp (TTL)	1 RJ-45 connector
OUTPUTS:	1 RJ-45 connector	1 DVI, 1.2Vpp on a DVI Molex 24-pin female connector; DDC signal 5Vpp (TTL)
BANDWIDTH:	Supports up to 1.65Gbps	
POWER SOURCE:	12V DC, 250mA	12V DC, 250mA
DIMENSIONS:	6.2cm x 5.2cm x 2.4cm (2.4" x 2.1" x 1") W, D, H.	
WEIGHT:	0.14kg (0.3lbs)	
ACCESSORIES:	Power supply, mounting bracket	
OPTIONS:	19" RK-4PT rack adapter, Kramer DVI cables ² and BC-DGKat524 (CAT 5 24 AWG), BC-DGKat623 (CAT 6 23 AWG) and BC-DGKat7a23 (CAT 7a 23 AWG) cables	

¹ Specifications are subject to change without notice

² The complete list of Kramer cables is on our Web site at <http://www.kramerelectronics.com>

LIMITED WARRANTY

Kramer Electronics (hereafter *Kramer*) warrants this product free from defects in material and workmanship under the following terms.

HOW LONG IS THE WARRANTY

Labor and parts are warranted for three years from the date of the first customer purchase.

WHO IS PROTECTED?

Only the first purchase customer may enforce this warranty.

WHAT IS COVERED AND WHAT IS NOT COVERED

Except as below, this warranty covers all defects in material or workmanship in this product. The following are not covered by the warranty:

1. Any product which is not distributed by Kramer, or which is not purchased from an authorized Kramer dealer. If you are uncertain as to whether a dealer is authorized, please contact Kramer at one of the agents listed in the Web site www.kramerelectronics.com.
2. Any product, on which the serial number has been defaced, modified or removed, or on which the WARRANTY VOID IF TAMPERED sticker has been torn, reattached, removed or otherwise interfered with.
3. Damage, deterioration or malfunction resulting from:
 - i) Accident, misuse, abuse, neglect, fire, water, lightning or other acts of nature
 - ii) Product modification, or failure to follow instructions supplied with the product
 - iii) Repair or attempted repair by anyone not authorized by Kramer
 - iv) Any shipment of the product (claims must be presented to the carrier)
 - v) Removal or installation of the product
 - vi) Any other cause, which does not relate to a product defect
 - vii) Cartons, equipment enclosures, cables or accessories used in conjunction with the product

WHAT WE WILL PAY FOR AND WHAT WE WILL NOT PAY FOR

We will pay labor and material expenses for covered items. We will not pay for the following:

1. Removal or installations charges.
2. Costs of initial technical adjustments (set-up), including adjustment of user controls or programming. These costs are the responsibility of the Kramer dealer from whom the product was purchased.
3. Shipping charges.

HOW YOU CAN GET WARRANTY SERVICE

1. To obtain service on you product, you must take or ship it prepaid to any authorized Kramer service center.
2. Whenever warranty service is required, the original dated invoice (or a copy) must be presented as proof of warranty coverage, and should be included in any shipment of the product. Please also include in any mailing a contact name, company, address, and a description of the problem(s).
3. For the name of the nearest Kramer authorized service center, consult your authorized dealer.

LIMITATION OF IMPLIED WARRANTIES

All implied warranties, including warranties of merchantability and fitness for a particular purpose, are limited in duration to the length of this warranty.

EXCLUSION OF DAMAGES

The liability of Kramer for any effective products is limited to the repair or replacement of the product at our option. Kramer shall not be liable for:

1. Damage to other property caused by defects in this product, damages based upon inconvenience, loss of use of the product, loss of time, commercial loss; or:
2. Any other damages, whether incidental, consequential or otherwise. Some countries may not allow limitations on how long an implied warranty lasts and/or do not allow the exclusion or limitation of incidental or consequential damages, so the above limitations and exclusions may not apply to you.

This warranty gives you specific legal rights, and you may also have other rights, which vary from place to place.

NOTE: All products returned to Kramer for service must have prior approval. This may be obtained from your dealer.

This equipment has been tested to determine compliance with the requirements of:

- EN-50081: "Electromagnetic compatibility (EMC);
generic emission standard.
Part 1: Residential, commercial and light industry"
EN-50082: "Electromagnetic compatibility (EMC) generic immunity standard.
Part 1: Residential, commercial and light industry environment".
CFR-47: FCC* Rules and Regulations:
Part 15: "Radio frequency devices
Subpart B Unintentional radiators"

CAUTION!

- Servicing the machines can only be done by an authorized Kramer technician. Any user who makes changes or modifications to the unit without the expressed approval of the manufacturer will void user authority to operate the equipment.
- Use the supplied DC power supply to feed power to the machine.
- Please use recommended interconnection cables to connect the machine to other components.
* FCC and CE approved using STP cable (for twisted pair products)



For the latest information on our products and a list of Kramer distributors, visit our Web site: www.kramerelectronics.com where updates to this user manual may be found. We welcome your questions, comments and feedback.



Caution

Safety Warning:

Disconnect the unit from the power supply before opening/servicing.



Kramer Electronics, Ltd.

Web site: www.kramerelectronics.com

E-mail: info@kramerel.com

P/N: 2900-000689 REV 3