



Owner's Manual

Original Instructions

Window Type Air Conditioner

Thank you for choosing our product.
Please read this Owner's Manual carefully before operation and retain it for future reference.
If you have lost the Owner's Manual, please contact the local agent or visit www.gree.com or send an email to global@cn.gree.com for the electronic version.

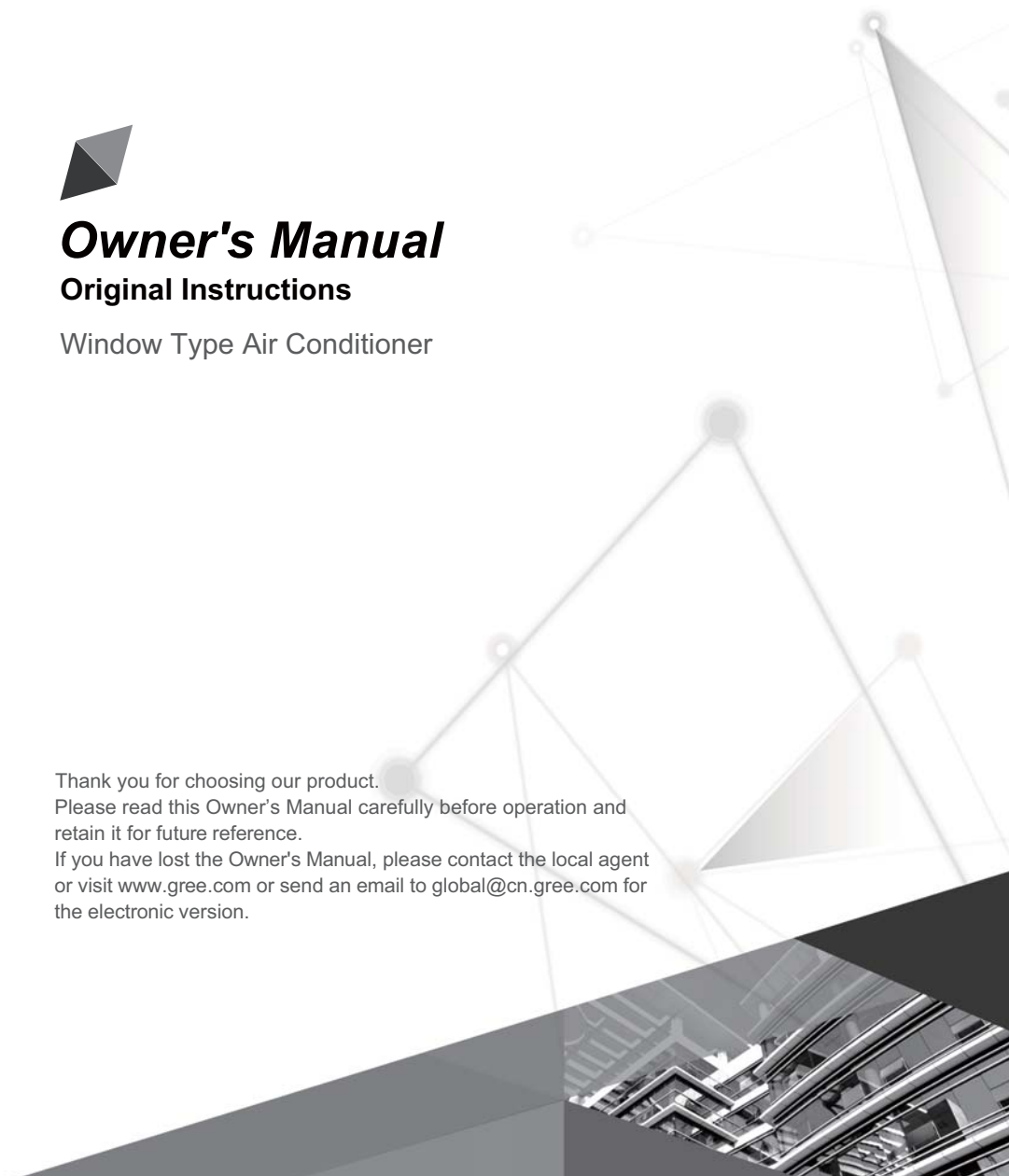

GJC12BR-A6NRNC5D
GJC12BR-A6NRND2B

Contents

Operation and Maintenance

Operation Notices

The Refrigerant.....	1
Safety Precautions.....	3
Precautions.....	6
Parts Name.....	7

Operation Guide

Function and Control.....	8
Introduction of remote controller....	11
Instruction for fan direction adjusting.....	14

Maintenance

Clean and Maintenance.....	15
----------------------------	----

Malfunction

Malfunction analysis.....	16
---------------------------	----

Installation

Installation Notice

Installation and Maintenance.....	19
Preparation before installation.....	21

Installation

Window types and requirements...22
Installation procedure.....23
Sponge Sticking Method and Procedures.....26
Safety operation of flammable refrigerant.....28
Safety notices for maintenance....30
Information on servicing.....32

READ THIS MANUAL

Inside you will find many helpful hints on how to use and maintain your air conditioner properly. Just a little preventive care on your part can save you a great deal of time and money over the life of your air conditioner. You'll find many answers to common problems in the chart of troubleshooting tips. If you review our chart of Troubleshooting Tips first, you may not need to call for service at all.

CAUTION

Contact the authorized service technician for repair or maintenance of this unit.

Contact the installer for installation of this unit.

The air conditioner is not intended for use by young children or infirm persons without supervision.

Young children should be supervised to ensure that they do not play with the air conditioner.

If the SUPPLY CORD is damaged, it must be replaced by the manufacturer, its service agent or similarly qualified persons in order to avoid a hazard.

Installation work must be performed in accordance with the national wiring standards by authorized personnel only.

This appliance is not intended for use by persons (including children) with reduced physical, sensory or mental capabilities or lack of experience and knowledge, unless they have been given supervision or instruction concerning use of the appliance by a person responsible for their safety. Children should be supervised to ensure they are away from the appliance.

This appliance can be used by children aged from 8 years and above and persons with reduced physical, sensory or mental capabilities or lack of experience and knowledge if they have been given supervision or instruction concerning use of the appliance in a safe way and understand the hazards involved.

Children shall not play with the appliance.

Cleaning and user maintenance shall not be made by children without supervision.

Instructions for cord-connected room air conditioners shall include manufacturer's recommendations regarding the use of cord sets (extension cords). If use of an extension cord is not recommended, the instructions shall state this. Recommendations for an extension cord shall specify at least the use of a cord set with an equipment grounding conductor, grounding-type attachment plug, and grounding-type connector (load fitting) and the ampacity and voltage rating of the cord set.

Exception Clauses

Manufacturer will bear no responsibilities when personal injury or property loss is caused by the following reasons.

1. Damage the product due to improper use or misuse of the product;
2. Alter, change, maintain or use the product with other equipment without abiding by the instruction manual of manufacturer;
3. After verification, the defect of product is directly caused by corrosive gas;
4. After verification, defects are due to improper operation during transportation of product;
5. Operate, repair, maintain the unit without abiding by instruction manual or related regulations;
6. After verification, the problem or dispute is caused by the quality specification or performance of parts and components that produced by other manufacturers;
7. The damage is caused by natural calamities, bad using environment or force majeure.

If it needs to install, move or maintain the air conditioner, please contact dealer or local service center to conduct it at first. Air conditioner must be installed, moved or maintained by appointed unit. Otherwise, it may cause serious damage or personal injury or death.

When refrigerant leaks or requires discharge during installation, maintenance, or disassembly, it should be handled by certified professionals or otherwise in compliance with local laws and regulations.

Please read this operating manual carefully before operating the unit.



Caution, risk of fire.



Before use the appliance, read the owner's manual first.



Before install the appliance, read the installation manual first.



Before repair the appliance, read the service manual first.

The figures in this manual may be different with the material objects, please refer to the material objects for reference.

The Refrigerant

- To realize the function of the air conditioner unit, a special refrigerant circulates in the system. The used refrigerant is the fluoride R32, which is specially cleaned. The refrigerant is flammable and inodorous. Furthermore, it can lead to explosion under certain conditions. But the flammability of the refrigerant is very low. It can be ignited only by fire.
- Compared to common refrigerants, R32 is a nonpolluting refrigerant with no harm to the ozoneosphere. The influence upon the greenhouse effect is also lower. R32 has got very good thermodynamic features which lead to a really high energy efficiency. The units therefore need a less filling.

WARNING:

Keep ventilation openings, in the appliance enclosure or in the built-in structure, clear of Obstruction.

Do not use means to accelerate the defrosting process or to clean, other than those recommended by the manufacture. Should repair be necessary, contact your nearest authorized Service Centre.

Any repairs carried out by unqualified personnel may be dangerous.

Do not pierce or burn.

Appliance shall be installed, operated and stored in a room with a floor area larger than $X \text{ m}^2$. (Please refer to table "a" in section of " Safety operation of flammable refrigerant " for Space X.)

Appliance filled with flammable gas R32. For repairs, strictly follow manufacturer's instructions only.

Be aware that refrigerants may not contain an odour.

Read specialist's manual.

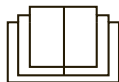



WARNING:

Do not use means to accelerate the defrosting process or to clean, other than those recommended by the manufacturer.

The appliance shall be stored in a room without continuously operating ignition sources (for example: open flames, an operating gas appliance or an operating electric heater.)

Do not pierce or burn. Be aware that refrigerants may not contain an odor.

Adopt R32 flammable refrigerant. When maintaining or disposing the unit, the refrigerant inside the system must be eliminated. Refrigerant should be recovered, which can't be discharged freely.

Keep ventilation opening clear of obstruction.

The unit can only be maintained according to the method suggested by manufacturer.

Appliance shall be stored in a room without continuously operating open flames (for example an operating gas appliance) and ignition sources (for example an operating electric heater) close to the appliance. No open fire (fired equipment such as electrical heater and gas stove etc.) or any equipment (e.g. switch) that might generate arc around the appliance.

The appliance shall be stored so as to prevent mechanical damage from occurring.

NOTE:

Any person who is involved with working on or breaking into a refrigerant circuit should hold a current valid certificate from an industry-accredited assessment authority, which authorizes their competence to handle refrigerants safely in accordance with an industry recognized assessment specification.

Servicing shall only be performed as recommended by the equipment manufacturer.

Maintenance and repair requiring the assistance of other skilled personnel shall be carried out under the supervision of the person competent in the use of flammable refrigerants.

Safety Precautions



DANGER

Indicates a hazardous situation that, if not avoided, will result in death or serious injury.



WARNING

Indicates a hazardous situation that, if not avoided, could result in death or serious injury.



CAUTION

Indicates a hazardous situation that, if not avoided, may result in minor or moderate injury.

NOTICE

Indicates important but not hazard-related information, used to indicate risk of property damage.



Indicates a hazard that would be assigned a signal word **WARNING** or **CAUTION**.

- Meaning of symbols used in this manual are as shown below.

	NEVER DO THIS.
	ALWAYS DO THIS.

WARNING

Plug in power plug properly

- Otherwise, it may cause electric shock or fire due to excess heat generation.

Do not operate or stop the unit by inserting or pulling out the power plug.

- It may cause electric shock or fire due to heat generation.

Do not damage or use an unspecified power cord.

- If the power cord is damaged, it must be replaced by the manufacturer or an authorized service center in order to avoid hazard.

Do not modify power cord length or share the outlet with other appliances.

- It may cause electric shock or fire due to heat generation.

Do not operate with wet hands or in damp environment.

- It may cause electric shock.

Do not direct airflow at room occupants only.

- This could damage your health.

Always ensure effective grounding.

- Incorrect grounding may cause electric shock.

Do not allow water to run into electric parts.

- It may cause failure of machine or electric shock.

Always install circuit breaker and a dedicated power circuit.

- Incorrect installation may cause fire and electric shock.

Unplug the unit if strange sounds, smell, or smoke comes from it.

- It may cause fire and electric shock.

Do not use the socket if it is loose or damaged.

- It may cause fire and electric shock.

Do not open the unit during operation.

- It may cause electric shock.

Keep firearms away.

- It may cause fire.

Do not use the power cord close to heating appliances.

- It may cause fire and electric shock.

Do not use the power cord near flammable gas or combustibles, such as gasoline, benzene, thinner, etc.

- It may cause an explosion or fire.

Ventilate room before operating air conditioner if there is a gas leakage from another appliance.

- It may cause explosion, fire and burns.

Do not disassemble or modify unit.

- It may cause failure and electric shock.

Safety Precautions

⚠ CAUTION

⊘ When the air filter is to be removed, do not touch the metal parts of the unit.

- It may cause an injury.

⊘ Do not clean the air conditioner with water.

- Water may enter the unit and degrade the insulation. It may cause an electric shock.

⊘ Ventilate the room well when used together with a stove, etc.

- An oxygen shortage may occur.

⊘ When the unit is to be cleaned, switch off, and turn off the circuit breaker.

- Do not clean unit when power is on as it may cause fire and electric shock, it may cause an injury.

⊘ Do not put a pet or house plant where it will be exposed to direct air flow.

- This could injure the pet or plant.

⊘ Do not use for special purposes.

- Do not use this air conditioner to preserve precision devices, food, pets, plants, and art objects. It may cause deterioration of quality, etc.

⊘ Stop operation and close the window in storm or hurricane.

- Operation with windows opened may cause wetting of indoor and soaking of household furniture.

⊘ Hold the plug by the head of the power plug when taking it out.

- It may cause electric shock and damage.

⊘ Turn off the main power switch when not using the unit for a long time.

- It may cause failure of product or fire.

⊘ Do not place obstacles around air-inlets or inside of air-outlet.

- It may cause failure of appliance or accident.

⊘ Ensure that the installation bracket of the outdoor appliance is not damaged due to prolonged exposure.

- If bracket is damaged, there is concern of damage due to falling of unit.

⊘ Always insert the filters securely. Clean the filter once every two weeks.

- Operation without filters may cause failure.

⊘ Do not use strong detergent such as wax or thinner but use a soft cloth.

- Appearance may be deteriorated due to change of product color or scratching of its surface.

⊘ Do not place heavy object on the power cord and ensure that the power cord is not compressed.

- There is danger of fire or electric shock.

⊘ Do not drink water drained from air conditioner.

- It contains contaminants and could make you sick.

⊘ Use caution when unpacking and installing. Sharp edges could cause injury.

⊘ If water enters the unit, turn the unit off at the power outlet and switch off the circuit breaker. Isolate supply by taking the power plug out and contact a qualified service technician.

Safety Precautions

The power supply cord with this air conditioner contains a current detection device designed to reduce the risk of fire. Please refer to the section "Operation of Current Device" for details. In the event that the power supply cord is damaged, it cannot be repaired-it must be replaced with a cord from the Product Manufacturer.

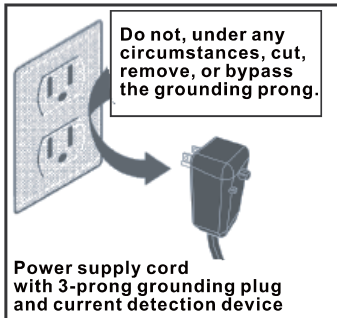

⚠ WARNING For your safety

- Do not store or use gasoline or other flammable vapors and liquids in the vicinity of this or any other appliance.
- Avoid fire hazard or electric shock. Do not use an extension cord or an adaptor plug. Do not remove any prong from the power cord.

⚠ WARNING Electrical Information

- Be sure the electrical service is adequate for the model you have chosen. This information can be found on the serial plate, which is located on the side of the cabinet and behind the grille.
 - Be sure the air conditioner is properly grounded. To minimize shock and fire hazards, proper grounding is important. The power cord is equipped with a three-prong grounding plug for protection against shock hazards.
 - Your air conditioner must be used in a properly grounded wall receptacle. If the wall receptacle you intend to use is not adequately grounded or protected by a time delay fuse or circuit breaker, have a qualified electrician install the proper receptacle.
 - Ensure the receptacle is accessible after the unit installation.
 - Do not run air conditioner without side protective cover in place. This could result in mechanical damage within the air conditioner.
- Do not use an extension cord or an adapter plug.**

Operation of Current Device

The power supply cord contains a current device that senses damage to the power cord. To test your power supply cord do the following:

1. Plug in the Air Conditioner.
2. The power supply cord will have TWO buttons on the plug head. Press the TEST button, you will notice a click as the RESET button pops out.
3. Press the RESET button, again you will notice a click as the button engages.
4. The power supply cord is now supplying electricity to the unit. (On some products this is also indicated by a light on the plug head.)

NOTICE:

- Do not use this device to turn the unit on or off.
- Always make sure the RESET button is pushed in for correct operation.
- The power supply must be replaced if it fails reset when either the TEST button is pushed, or it cannot be reset. Please contact Customer Service.
- If power supply cord is damaged, it cannot be repaired. It MUST be replaced with a new cord - please contact Customer Service.

Precautions

Warning

- Air Conditioner should be properly grounded. Incorrect grounding may cause electric shock.
- Do not connect air conditioner to multipurpose socket. Otherwise, it may cause fire hazard.
- Do install the air switch. If not, it may cause malfunction.
- Do not spill water on the remote controller, otherwise the remote controller may be broken.
- Do not spray water on air conditioner. It may cause electric shock or malfunction.
- Do not extend fingers or objects into air inlet or air outlet. It may cause personal injury or damage.
- Do not step on air conditioner, or put heavy objects. It may cause damage or personal injury.
- Do not block air outlet or air inlet. It may cause malfunction.
- Do disconnect power supply when cleaning air conditioner. Otherwise, it may cause electric shock.
- Do not repair air conditioner by yourself. It may cause electric shock or damage. Please contact dealer when you need to repair air conditioner.
- Maintenance must be performed by qualified professionals. Otherwise, it may cause personal injury or damage.

Note:

The power cord of window type unit has creepage protection device. There're test button and reset button on the plug. You are suggested to check the power cord periodically.

Check method:

After putting through the power, indicator is ON. After pressing test button, indicator is OFF and you can heard a sound. Then press reset button, indicator will be ON, which indicates the protection device is normal.

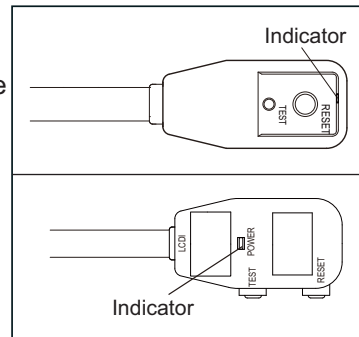

Note: Plug may be different with the actual product. Please refer to actual product.

Working temperature range

※ Operating Temperature Range		
	Indoor side DB/WB(°C/°F)	Outdoor side DB/WB(°C/°F)
Maximum cooling	40°C(104°F)/26.7°C(80°F)	40°C(104°F)/26.7°C(80°F)

The operating temperature range (outdoor temperature) for cooling only unit is 18°C~ 40°C(65~ 104°F).

Parts Name

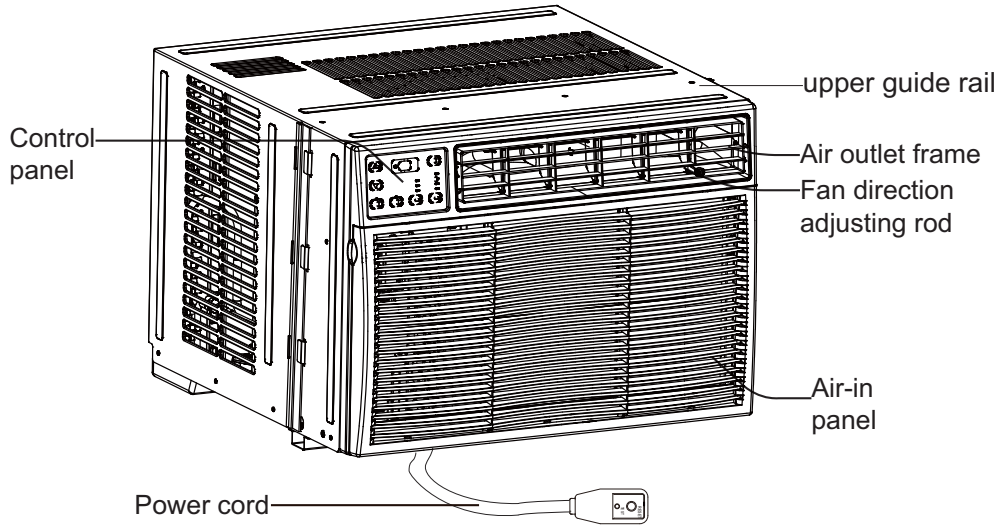

Function and Control

- After putting through the power, air conditioner will give out a sound and indicators on control panel will be on. After that, you operate the air conditioner through remote controller or control panel.

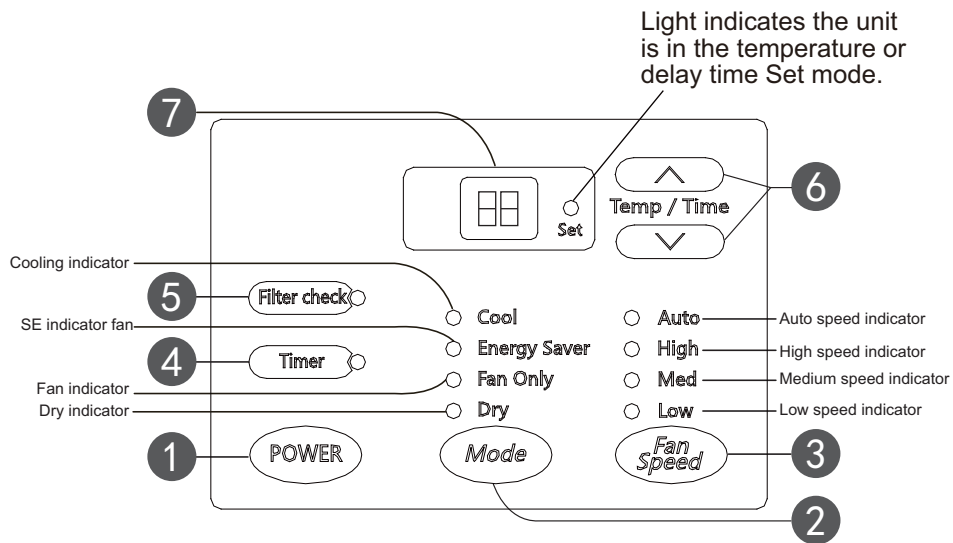

- ① Power button
- ② Mode button
- ③ Fan Speed button
- ④ Timer button
- ⑤ Filter check button
- ⑥ ^ / v button
- ⑦ Display

1 Power button

Press this button can turn on or turn off air conditioner.

NOTE: Press this button to turn on air conditioner, the unit will operate in Energy Save mode; if the unit is energized after power failure, the unit will still operate according to the status before power failure.

2 Mode button

Press this button can your required operation mode in turn. Corresponding indicator will be on.

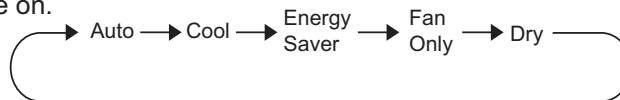

- **Auto:** Under this mode, the unit will operate automatically according to ex-factory setting. In this case, set temperature cannot be adjusted.
- **Cool:** Under this mode, air conditioner operates under cooling mode. Cooling indicator will be on. Press “Fan Speed” button can adjust the fan speed.
- **Energy Save:** Under this mode, air conditioner operates under SE mode. SE indicator will be on. Press “Fan Speed” button can adjust the fan speed.
- **Fan Only:** Under this mode, air conditioner will not cool or heat, only blow wind. Fan indicator will be on. Press “Fan Speed” button can adjust the fan speed. (No auto fan speed under fan mode)
- **Dry:** Under this mode, the unit runs in low fan speed for dehumidification and the corresponding indicator is on; under dry mode, the fan speed cannot be adjusted.

3 Fan Speed button

Press this button can select your required fan speed in turn. Corresponding speed indicator will be on.

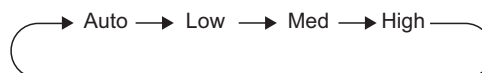

4 Timer button

Timer ON: Can be set under off state of unit. If timer ON reaches, the system will run under Energy Save mode. The setting range is 0.5~24hr.

Timer OFF: Can be set under on state of unit. If timer OFF reaches, the unit will turn off. The timer can be set in 0.5 hour increment below 10 hours and in 1 hour increment for 10 hours or above.

5 Filter check button

After fan rotates for 250h totally, lamp of cleaning filter is on to remind customer clean it.

Note: When user cleaned the filter, press Filter check button to clear the operation time. Meanwhile, the warning indicator will turn off.

6 ^ / v button

Under temperature setting status, after each pressing of “^” or “v” button, temperature will increase or decrease 1°C. Temperature setting range: 16~30°C. Under timer setting status, after each pressing of “^” or “v” button, time will increase or decrease 0.5h or 1h.

7 Display

1. Under ON status without timer setting, the operation mode is Auto, Cool, Energy Saver or Dry mode, and the set temperature will be displayed.
2. Under ON status without timer setting, the operation mode is fan mode and the ambient temperature will be displayed.
3. Time will be displayed under timer setting or timer preview.

Introduction of remote controller

Note:

This is a general use remote controller, it could be used for the air conditioners with multifunction; For some function, which the model doesn't have, if press the corresponding button on the remote controller that the unit will keep the original running status.

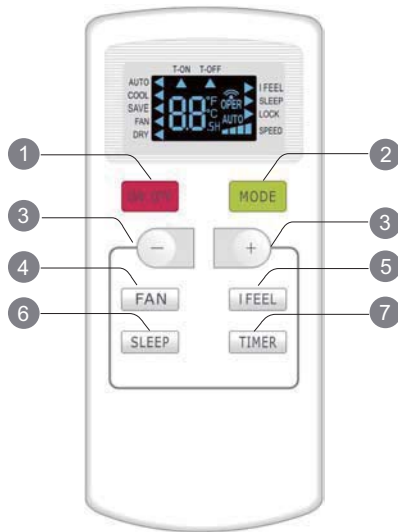

- 1 ON/OFF button
- 2 MODE button
- 3 + / - button
- 4 FAN button
- 5 I FEEL button
- 6 SLEEP button
- 7 TIMER button

1 ON/OFF button

Press this button to turn on the unit, turning on the unit with remote controller, the unit will operate in energy-saving mode. Press this button again to turn off the unit. NOTE: If energize the unit and turn it on, or turn it off and then turn it on, the unit will operate in energy-saving mode; if the unit is energized after power failure, the unit will still operate according to the status before power failure.

2 MODE button

Each time you press the button, a mode is selected in a sequence that goes from AUTO, COOL, SAVE, FAN and DRY, as the following:

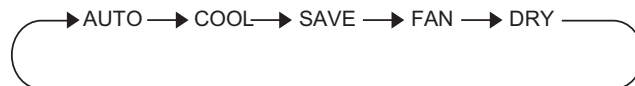

3 - / + button

- Pressing + or - button once will increase or decrease set temperature by 1°F(°C). Hold + or - button for 2s, set temperature on remote controller will change quickly. Release the button after your required set temperature is reached.
- Under timer setting status, after each pressing of “+” or “-” button, time will increase or decrease 0.5h . Hold “+” or “-” button, 2s later, time displayed on dual-8 nixie tube will change quickly. Loosen the button until the time is reached to your set time.

4 FAN button

This button is used for setting Fan Speed in the sequence that goes from AUTO,

▲, ▲▲, ▲▲▲, to ▲▲▲▲ then back to Auto.

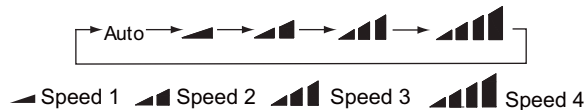

NOTE: There are 3 speeds for the Fan Speed of this model.

5 I FEEL button

I feel function will be action if pressing this button. If controller receives I FEEL order, it will work under ambient temperature value which sending by remote controller, and remote controller will send ambient temperature value to controller every 10min. After 11min, if controller does not receive ambient temperature value which sending by remote controller, it will run with AC ambient temperature; if I FEEL is not set, ambient temperature will adopt sampling value of AC temperature sensor. If power off happens, this function will not be memorized.

6 SLEEP button

Press this button to go into the SLEEP operation mode. Press it again to cancel this function. This function is available in COOL, HEAT (Only for models with heating function) or DRY mode to maintain the most comfortable temperature for you.

7 TIMER button

Press this button to initiate auto-on/auto-off timer. To cancel auto-timer program, press this button twice.

Replacement of Batteries in Remote Controller

1. Press the mark “” on back cover of batteries box cover for remote controller with fingers as shown in the fig, and then remove the batteries box cover along the arrow direction.
2. Replace with two #7 (AAA 1.5V) dry batteries. Make sure positions for “+” pole and “-” pole are correct.
3. Reinstall batteries box cover.

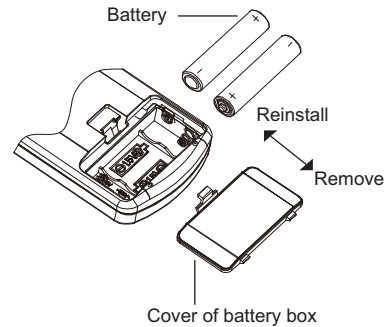

NOTICE

- The distance between signal sender and receiving window should be no more than 8m, and there should be no obstacles between them.
- As the signal will be interfered in the room with electronic fluorescent lamp, conversion fluorescent lamp or wireless phone, please get closer to the air conditioner when using the remote controller.
- Replace new batteries of the same model when replacement is required.
- When you don't use remote controller for a long time, please take out the batteries.

Instruction for fan direction adjusting

- You can adjust the fan direction adjusting rod to select left&right air outlet direction according to your requirement.

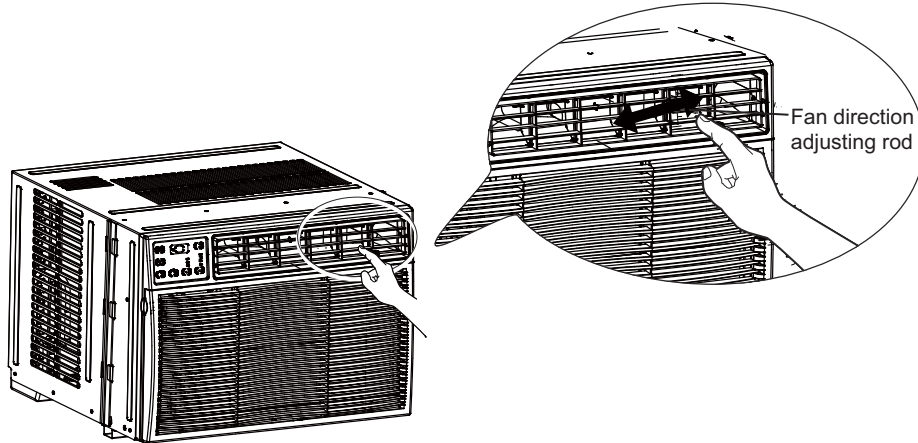

- You can adjust the air outlet frame to select up&down air outlet direction according to your requirement.

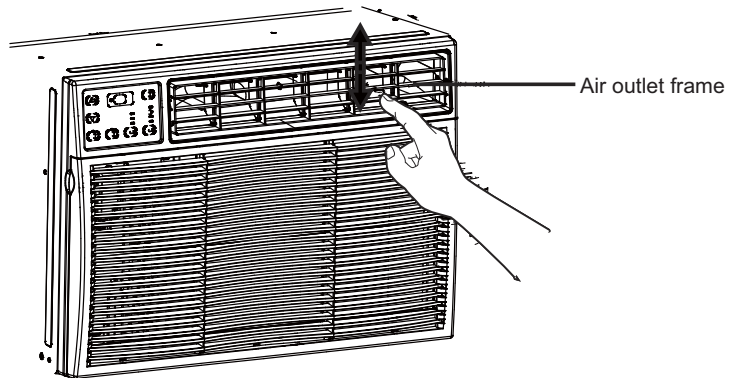

Clean and Maintenance

WARNING

- Turn off the air conditioner and disconnect the power before cleaning the air conditioner to avoid electric shock.
- Do not wash the air conditioner with water to avoid electric shock.
- Do not use volatile liquid to clean the air conditioner.

Clean filter

1. Open the panel
Pull the groove at both sides of panel forcibly to open the panel to a certain angle as shown in the fig.
2. Remove the filter
Remove the filter as shown in the fig.
3. Clean the filter
 - Use dust catcher or water to clean the filter.
 - If the filter is very dirty, you can use the warm water (below 45 degree) dissolved with neutral abluent, and then put it under the shady place.
4. Install filter
Install the filter and then buckle the panel cover tightly.

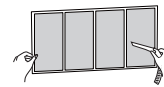
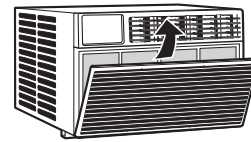
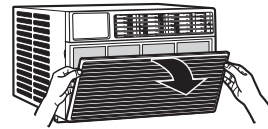

NOTICE:

- Clean the filter about once every three month. If there are lots of dust in operation environment , you can increase the clean times.
- Due to there's shaft metal fins in the air conditioner, do no touch the fins after removing filter to avoid scratching.
- Do not dry the filter on fire or use hair drier to dry the filter. Otherwise, the filter may be deformed or catch fire.
- Do not operate the air conditioner when the filter hasn't been installed.

Clean the panel

If the surface of panel is very dirty, you are suggested to use soft dry cloth or wet cloth dipped with neutral abluent to wipe it.

Note: Do not remove the panel when cleaning it.

Maintain the outer case

You are suggested to check the outer case of air conditioner one or twice every year. If the outer case is damaged or rusted, please contact dealer.

Note: In order to reduce damage or rust under no-use season, you can cover the air conditioner with protective covering.

Qualification of workers

Qualification of the working personnel for maintenance, service and repair operations should according to CAS/UL 60335-2-40:17 Annex HH.. Every working procedure that affects safety means shall only be carried out by competent persons according to Annex HH. Special training additional to usual refrigerating equipment repair procedures is required when equipment with FLAMMABLE REFRIGERANTS is affected.

Malfunction analysis

General phenomenon analysis

Please check below items before asking for maintenance. If the problem still can't be solved, please contact dealer or professional person.

Phenomenon	Troubleshooting	Solution
Air conditioner can't operate	• Power failure?	• Wait after power recovery.
	• Is plug loose?	• Reinsert the plug.
	• Whether the air switch is tripped off or fuse is burnt?	• Ask professional person to replace air switch or fuse.
	• Is there's malfunction for the circuit?	• Ask professional person to replace circuit.
	• Whether the unit is restarted up after stopping immediately?	• Wait after voltage is resumed.
	• The protection device for the plug of power cord trips off?	• Please press reset button on plug again. If the power trips off again and heard a sound, there's malfunction for the plug or the unit. Please contact after-sales maintenance person.
Poor cooling (heating)	• Is the power too low?	• Wait after voltage is resumed.
	• Whether the air filter is too dirty?	• Clean the air filter.
	• Whether the set temperature is proper?	• Adjust the temperature.
	• Whether door and window are closed?	• Close door and window.

Air conditioner can't receive signal from remote controller or remote controller is not sensible.	<ul style="list-style-type: none"> Whether the unit is interfered seriously (such as static pressure, unstable voltage)? 	<ul style="list-style-type: none"> Please pull out the plug. Insert the plug after about 3min, and then turn on the unit.
	<ul style="list-style-type: none"> Whether remote controller is within the receiving range? 	<ul style="list-style-type: none"> The receiving range of remote controller is 8m. Do not exceed this range.
	<ul style="list-style-type: none"> Whether it's blocked by obstacles? 	<ul style="list-style-type: none"> Remove the obstacles.
	<ul style="list-style-type: none"> Is sensitivity of remote controller low? 	<ul style="list-style-type: none"> Check the batteries of remote controller. If the power is low, please replace the batteries.
	<ul style="list-style-type: none"> Whether there's fluorescence lamp in the room? 	<ul style="list-style-type: none"> Move the remote controller close to air conditioner. Turn off the fluorescence lamp and try it again.
No fan blowed out from air conditioner	<ul style="list-style-type: none"> Whether air outlet or air inlet is blocked? 	<ul style="list-style-type: none"> Eliminate the obstacles.
	<ul style="list-style-type: none"> Under heating mode, whether indoor temperature is reached to set temperature? 	<ul style="list-style-type: none"> The unit will stop blowing fan after reaching to set temperature.
	<ul style="list-style-type: none"> Whether heating mode is started up just now? 	<ul style="list-style-type: none"> In order to prevent cold air, air conditioner will delay for a while to be started up, which is the normal phenomenon.
Set temperature can't be adjusted	<ul style="list-style-type: none"> Whether the unit operates under auto mode or Fan mode? 	<ul style="list-style-type: none"> Temperature can't be adjusted under auto mode or Fan mode.
	<ul style="list-style-type: none"> Whether the required temperature exceeds the temperature setting range? 	<ul style="list-style-type: none"> Temperature setting range: 61°F ~86°F.
There's off flavour	<ul style="list-style-type: none"> There's off-flavour source in the room, such as furniture, cigarette etc. 	<ul style="list-style-type: none"> Eliminate the off-flavor source.
		<ul style="list-style-type: none"> Clean the filter.
There's abnormal sound during operation	<ul style="list-style-type: none"> Whether the unit is interfered by thunder, radio, etc? 	<ul style="list-style-type: none"> Disconnect power, put through the power again, and then turn on the unit again.
You can heard water-flowing sound	<ul style="list-style-type: none"> Whether the unit is turned on or turned off just now? 	<ul style="list-style-type: none"> There's flowing sound of refrigerant inside the air conditioner, which is the normal phenomenon.
You can heard the sound of "PAPA"	<ul style="list-style-type: none"> Whether the unit is turned on or turned off just now? 	<ul style="list-style-type: none"> Heat expansion or shrinkage for the panel due to change of temperature, which cause friction sound.

Malfunction code

When there's abnormal phenomenon for the air conditioner, dual-8 nixie tube displays corresponding malfunction code:

Malfunction code	Solution
FO、F1、F2、F4	Please contact professional person to deal with it.
H3、E8	High temperature protection of condenser

Note:

HS malfunction codes are only applicable for electric heating model.

WARNING

- If there's below phenomenon, please turn off the air conditioner and disconnect the power immediately. After that, please contact dealer at once.
 - Power cord is overheating or damaged.
 - There's abnormal sound during operation.
 - There's burning smell.
 - Power cord test or reset button often bounces automatically.
 - Water leakage at indoor side.
- Do not repair or refit the air conditioner by yourself.
- Operate the air conditioner under abnormal status will cause malfunction, electric shock or fire hazard.

Installation and Maintenance

Warning

- Observe all governing codes and ordinances.
- Do not use damaged or non-standard power cord.
- Be caution during installation and maintenance. Prohibit incorrect operation to prevent electric shock, casualty and other accidents.

Selection of Installation Location

Basic requirement

Installing the unit in the following places may cause malfunction. If it is unavoidable, please consult the local dealer:

1. The place with strong heat sources, vapors, flammable or explosive gas, or volatile objects spread in the air.
2. The place with high-frequency devices (such as welding machine, medical equipment).
3. The place near coast area.
4. The place with oil or fumes in the air.
5. The place with sulfureted gas.
6. Other places with special circumstances.

Requirement of complete unit

1. There should be no obstruction near air inlet and air outlet.
2. Select a location where the condensation water can be dispersed easily and won't affect other people.
3. The location should be able to withstand the weight of the unit and won't increase noise and vibration.
4. Select a location where the noise and outflow air emitted by the unit will not affect neighborhood.
5. The location should be able to withstand the weight of unit.
6. Select a location which is out of reach for children and far away from animals or plants. If it is unavoidable, please add fence for safety purpose.
7. Please try your best to keep far away from fluorescent lamp.

Requirements for Electric Connection

Safety precaution











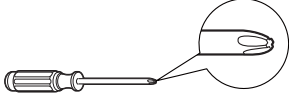

1. Must follow the electric safety regulations when installing the unit.
2. According to the local safety regulations, use qualified power supply circuit and air switch.
3. Make sure the power supply matches with the requirement of air conditioner. Unstable power supply or incorrect wiring may result in electric shock, fire hazard or malfunction.
4. Please make sure the power supply complies with the requirement of air conditioner. Unstable power supply or wrong wiring may lead to electric shock, fire hazard or malfunction.
5. Properly connect the live wire, neutral wire and grounding wire of power socket.
6. Be sure to cut off the power supply before proceeding any work related to electricity and safety.
7. Do not put through the power before finishing installation.
8. The air conditioner is first class electric appliance. It must be properly grounding with specialized grounding device by a professional. Please make sure it is always grounded effectively, otherwise it may cause electric shock.
9. The yellow-green wire or green wire in air conditioner is grounding wire, which can't be used for other purposes.
10. The grounding resistance should comply with national electric safety regulations.

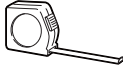
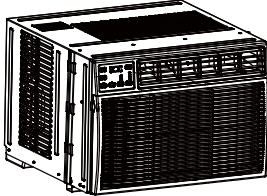
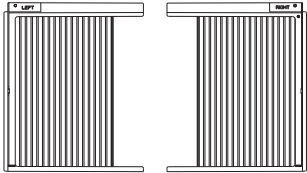
Electric wiring

- Must connect with ground reliably.
- The exclusive circuit must be used. But removable socket can't be used because poor contact of it can cause over heat or fire.
- Don't pull the power cord strongly.
- Connecting method between air conditioners and power cord and interconnecting method of each individual element with one another should accord with wiring diagram on the unit.
- The air conditioner should be installed in accordance with national wiring regulation.
- An all-pole disconnection switch having a contact separation of at least 3mm in all poles should be connected in fixed wiring.
- Air switch (thermal-magnetic breaker) should be installed in the circuit.

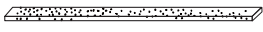

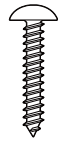
Preparation before installation

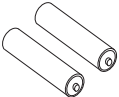
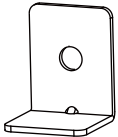
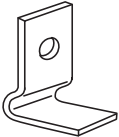
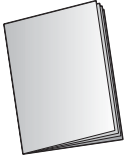
Tools for installation					
	Phillips-head screwdriver		Flat-blade screwdriver		
					
	Level	Scissors or knife	Pencil	Ruler or tape measure	
Spare parts list					
	Air conditioner		Left and right accordion panel		
					
	Window sill and sash seal (2)		Top mounting rail		
					
	Foam top window gasket		Top mounting rail seal strip		
					
	Accordion panel seal (2)	Foam Insulation (2)	Type A screws(4)	Type B screws(6)	
					
	Remote controller	Batteries	Window locking bracket (1)	Frame locking bracket (2)	User Manual

Window types and requirements

Note:

- The description for below installation is for the standard window. If it's other types of window, you may need to adjust the window.
- If you need to install the air conditioner at the small window, you may not need to use the accordion panel sub-assy. Please refer to requirement of window size for details.
- All parts used for supporting air conditioner should be fixed at solid wooden strap, brick or metal.
- Socket must be installed at the position where the power cord is available.

Standard window

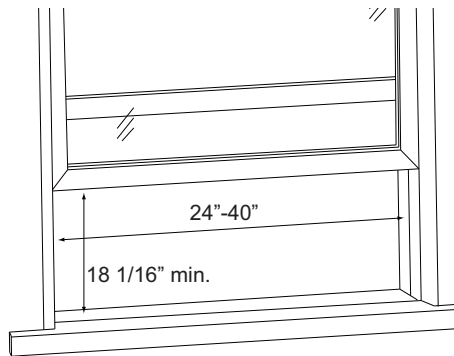

Weather-proof type window

The height of window frame is higher than windowsill for some weather-proof type window, which will affect the installation of air conditioner. In this case, before installing the air conditioner, add wooden strap on the windowsill, and fix the wooden strap at the windowsill.

Specification of wooden strap:

Width: about 2"

Length: same to the inner frame size of window

Height: Put the wooden strap on the windowsill, top part of wooden strap and window frame should be at the same horizontal level, or higher than the top part of window frame for about 1/2"

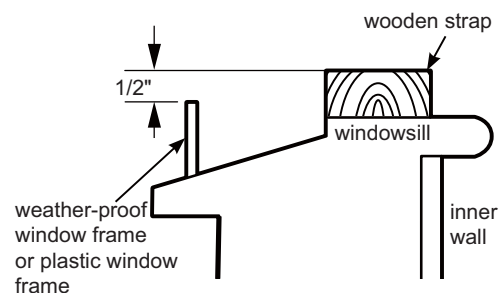

Installation procedure

Location

How to install:

- Choose a location where there are no any obstacle surrounding the unit, and the plug is accessible.
- Choose the installation space according to the following diagram.

The distance between the air conditioner and the around obstacles should meet the requirement as below: over 300mm (upper side), over 500mm (left side), over 500mm (right side), over 1500mm (front side) and over 500mm (rear side).

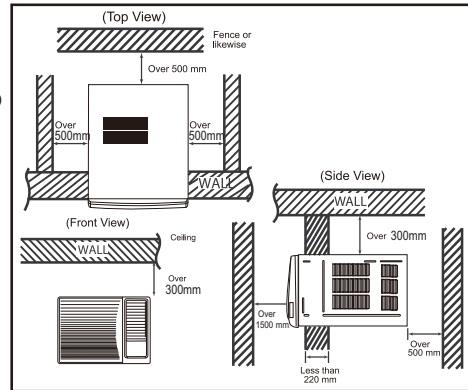

Step 1: Install top mounting rail

1. Tear off the paster at back side of top mounting rail seal strip, and then align it at the bottom edge of top mounting rail to stick the top mounting rail rseal strip at the bottom of top mounting rail. (The top mounting rail seal strip has been stick on the top mounting rail for some models. Therefore, this step can be omitted.)

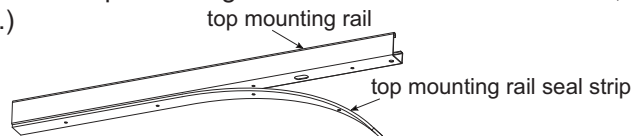

2. Use 4 type A screws to fix the top mounting rail at the outer case of air condition. (The top mounting rail has been fixed on the conditioner for some models. Therefore, this step can be omitted.)

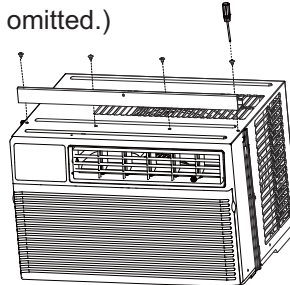

Step 2: Install accordion panel

1. Stick one accordion panel seal respectively on the left side and right side of accordion panel installation frame, as shown in the figure.

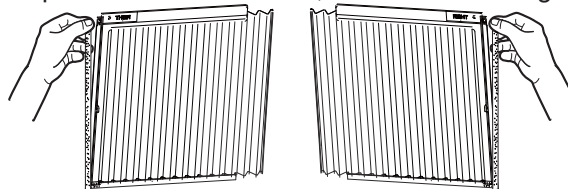

2. Undraw the accordion panel, install the accordion panel marked with "LEFT", "RIGHT" at both sides of air conditioner in turn. Slide the upper and lower ends of accordion panel into top mounting rail and lower guide rails.

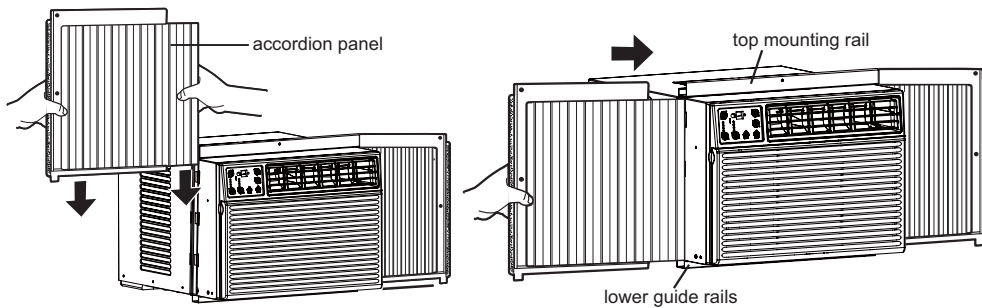

Step 3: Stick window sill and sash seal

Cut the window sill and sash seal into proper length. Tear off the paster and then stick the seal at the lower part of the window frame.

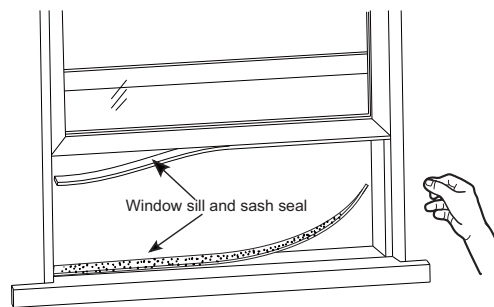

Step 4: Put the air conditioner

1. 2 Ask 2 persons to put the air conditioner at the windowsill, and the lower guide rail should be stick at the windowsill. Top mounting rail stays at the middle lower side of window and then window can stick to the top mounting rail when closing it. Please note that the air conditioner should be placed at horizontal place or inclined outwards slightly.

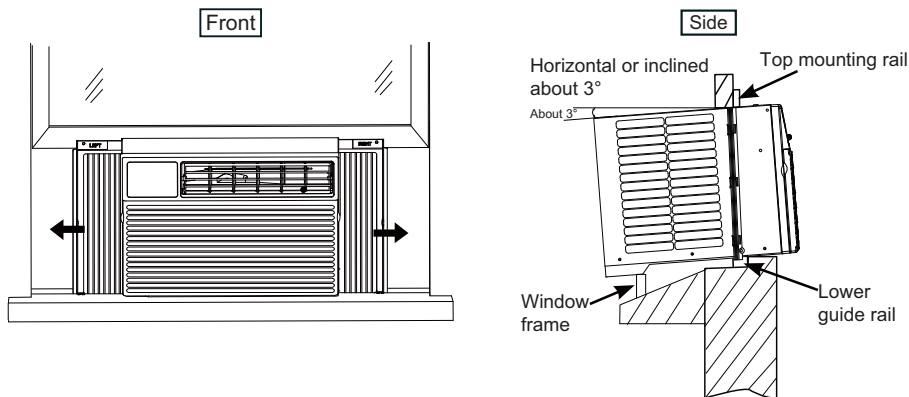

2. Pull the window, undraw accordion panels at both sides to keep it vertical to the window frame and then use 5 type B screws and frame locking bracket to fix the frame of accordion panel at window frame and windowsill.

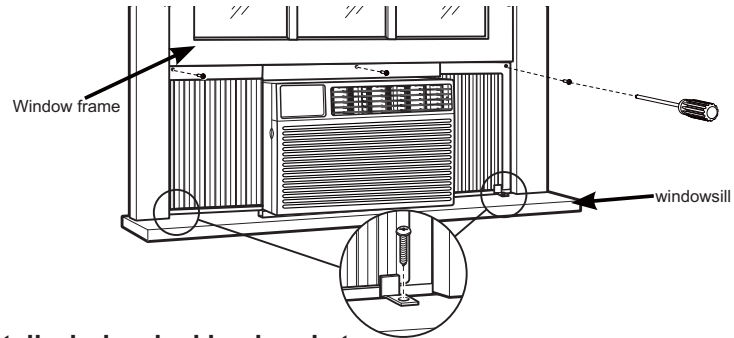

Step 5: Install window locking bracket

Install the window locking bracket at the window frame to fix the window .

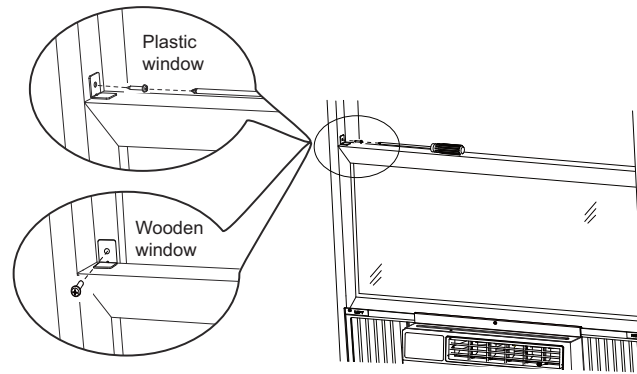

Step 6: Plug foam top window gasket

Cut the foam top window gasket into the length same to the width of window. Plug the foam between glasses and window to prevent rain and insects getting into the room.

Note:

If foam top window gasket is not proper to your window, you can select other proper materials to replace it.

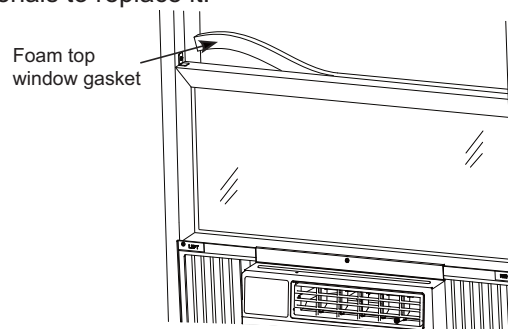

Sponge Sticking Method and Procedures

1. Install accordion panel sub-assy. After finishing installation, measure the width L between outer case of air conditioner and window frame.

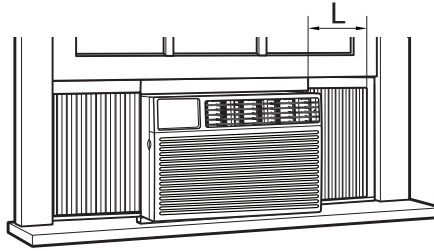

2. Take out foam insulation from the package. Cut off the foam insulation in rectangular shape with scissors.

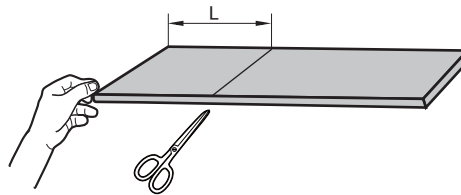

3. Stick foam insulation evenly on the accordion panel and the screen of window frame. The redundant 2~3mm of foam insulation in height can be stuffed into the frame for fixing.

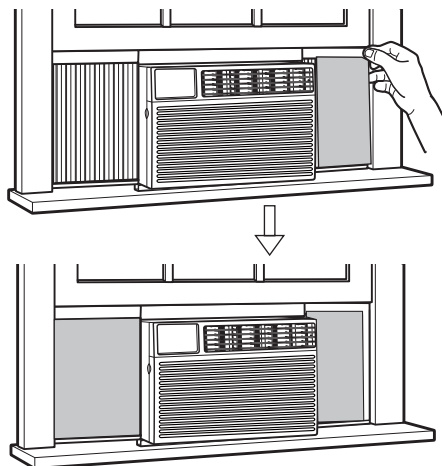

4: Drain water

To get the maximum cooling efficiency , the air conditioner is designed to splash the condensate on the condenser coil. If the splashing sound annoys you, you can provide an outside drain by using the following procedure, which may however cause a small loss of performance.

1. The air conditioner have the drainage gasket-Figure 1
2. Remove the drainage gasket from the body base plate- Figure 2.

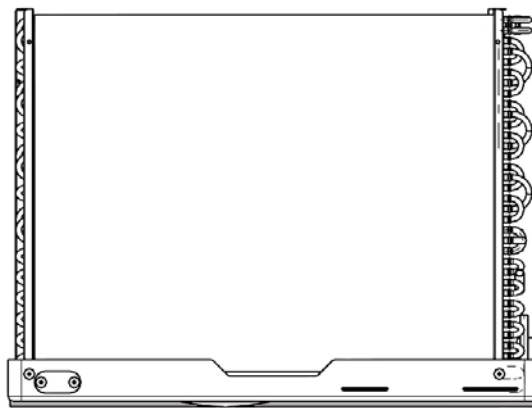

Figure 1



Figure 2

Safety operation of flammable refrigerant

■ Qualification requirement for installation and maintenance man

1. All the work men who are engaging in the refrigeration system should bear the valid certification awarded by the authoritative organization and the qualification for dealing with the refrigeration system recognized by this industry. If it needs other technician to maintain and repair the appliance, they should be supervised by the person who bears the qualification for using the flammable refrigerant.
2. It can only be repaired by the method suggested by the equipment's manufacturer.

■ Installation notes

1. The air conditioner is not allowed to use in a room that has running fire (such as fire source, working coal gas ware, operating heater).
2. The air conditioner must be installed in a room that is larger than the minimum room area.
The minimum room area is shown on the nameplate or following table.
3. Leak test is a must after installation.

table a- Minimum room area (m²)

Minimum room area(m ²)	Charge amount (kg)	≤1.2	1.3	1.4	1.5	1.6	1.7	1.8	1.9	2	2.1	2.2	2.3	2.4	2.5
	floor location	/	14.5	16.8	19.3	22	24.8	27.8	31	34.3	37.8	41.5	45.4	49.4	53.6
window mounted	/	5.2	6.1	7	7.9	8.9	10	11.2	12.4	13.6	15	16.3	17.8	19.3	
wall mounted	/	1.6	1.9	2.1	2.4	2.8	3.1	3.4	3.8	4.2	4.6	5	5.5	6	
ceiling mounted	/	1.1	1.3	1.4	1.6	1.8	2.1	2.3	2.6	2.8	3.1	3.4	3.7	4	

■ Maintenance notes

1. Check whether the maintenance area or the room area meet the requirement of the nameplate.
 - It's only allowed to be operated in the rooms that meet the requirement of the nameplate.
2. Check whether the maintenance area is well-ventilated.
 - The continuous ventilation status should be kept during the operation process.
3. Check whether there is fire source or potential fire source in the maintenance area.
 - The naked flame is prohibited in the maintenance area; and the "no smoking" warning board should be hanged.
4. Check whether the appliance mark is in good condition.
 - Replace the vague or damaged warning mark.

■ **Welding**

1. If you should cut or weld the refrigerant system pipes in the process of maintaining, please follow the steps as below
 - a. Shut down the unit and cut power supply
 - b. eliminate the refrigerant
 - c. vacuuming
 - d. clean it with N₂ gas
 - e. cutting or welding
 - f. carry back to the service spot for welding
2. The refrigerant should be recycled into the specialized storage tank.
3. Make sure that there isn't any naked flame near the outlet of the vacuum pump and it's well-ventilated.

■ **Filling the refrigerant**

1. Use the refrigerant filling appliances specialized for R32. Make sure that different kinds of refrigerant won't contaminate with each other.
2. The refrigerant tank should be kept upright at the time of filling refrigerant.
3. Stick the label on the system after filling is finished (or haven't finished)
4. Don't overfilling.
5. After filling is finished, please do the leakage detection before test running; another time of leak detection should be done when it's removed.
6. The filling-work must be performed by authorized personnel only.

■ **Safety instructions for transportation and storage**

1. Please use the flammable gas detector to check before unload and open the container.
2. No fire source and smoking.
3. According to the local rules and laws.

Safety notices for maintenance

■ Storage after moving the unit

1. Do not puncture or light the unit.
2. The unit shall be stored in a room without continuous fire source (e.g. naked fire, litten gas appliance, operating electric heater).
3. The unit shall be stored in a ventilated place; the ventilation device shall operate normally and ventilation port shall be without obstacle;
4. Check the unit periodically to see if there is collision mark and if the appearance is good.
5. Check the electronic components (e.g. cable) periodically to see there is breakage.
6. Do not impact or collapse the unit to avoid leakage of refrigerant; if leakage is founded, please arrange ventilation immediately and ask the professionals for maintenance, in order to avoid a fire hazard.

■ Disposal and recycle

Disposal :

The technician shall be familiar with the device and all its characteristics before disposal. Proceeding safe recycle of refrigerant is recommended. If the recycled refrigerant shall be utilized, please analyze the sample of refrigerant and oil before proceeding. Please ensure the required power supply before testing. Please take the following operation:

1. Be familiar with the device and its operation;
2. Cut off power supply;
3. Make sure the following items before proceeding: If needed, mechanical operation device shall be convenient for the operation of refrigerant tank; all personal protection apparatuses shall be workable and they are used correctly; the whole recycle procedure shall be done under the instruction of qualified person; recycle device and refrigerant tank shall comply with relevant standards.
4. Please arrange vacuum pumping to the refrigeration system if possible; if vacuum status cannot be reached, please arrange vacuum pumping from several positions in order to recycle the refrigerant in different parts of the system;
5. Make sure the capacity of refrigerant tank is sufficient before starting recycle;
6. Start and operate the recycle device according to the operation instruction of manufacturer;
7. The refrigerant tank shall not be too full. (the filled liquid shall not exceed 80% of the capacity of refrigerant tank);
8. Do not exceed the maximum operation pressure although the duration is short;
9. Remove the refrigerant tank and device quickly after finishing operation and make sure all cut-off valves in the device are closed;
10. The recycled refrigerant cannot be filled into another refrigeration system before purification and inspection.

■ Disposal and recycle

Label :

The unit shall be labeled with data and note after scrapping and discharging refrigerant. Make sure the label on the unit can reflect the R32 refrigerant which it has been filled.

Recycle :

It's recommended to remove the refrigerant in the system before maintenance and disposal.

Put the refrigerant into the specialized refrigerant tank with refrigerant label. The refrigerant tank shall be equipped with pressure-relief valve and cut-off valve, which are in good condition. If possible, the empty tank should be dealt with vacuum pumping before using and keep it in normal temperature.

Recycling device shall be kept in good working status and equipped with operation instructions for reference. The device shall be applicable for the recycle of R32 refrigerant. In addition, qualified weighing apparatus which can be used normally shall be prepared. The hose shall adopt removable connector without leakage for connection and keep it in good status. Check if the recycling device is in normal status before using it and if it is properly stored with all electrical components sealed to prevent fire hazard caused by refrigerant leakage. If you have any question, please consult with the manufacturer.

The recycled refrigerant shall be put in proper container attached with transportation instruction and send it back to the refrigerant manufacturer. Do not mix different refrigerants in the refrigerant recycle device, especially the refrigerant tank.

When disassembling the compressor or clearing the compressor oil, make sure the compressor has been dealt with vacuum pumping to suitable level, so that there is no R32 refrigerant remained in the lubricant. Vacuum pumping shall be done before the compressor is sent back to the supplier. Only electric heating can be adopted for heating the shell of compressor in order to speed up the course. When oil is drained from the system, please ensure the safety.

Information on servicing

■ Checks to the area

Prior to beginning work on systems containing FLAMMABLE REFRIGERANTS, safety checks are necessary to ensure that the risk of ignition is minimised.

■ General work area

All maintenance staff and others working in the local area shall be instructed on the nature of work being carried out. Work in confined spaces shall be avoided. The area around the workspace shall be sectioned off. Ensure that the conditions within the area have been made safe by control of flammable material.

■ Checking for presence of refrigerant

The area shall be checked with an appropriate refrigerant detector prior to and during work, to ensure the technician is aware of potentially toxic or flammable atmospheres. Ensure that the leak detection equipment being used is suitable for use with all applicable refrigerants, i.e. non-sparking, adequately sealed or intrinsically safe.

■ Presence of fire extinguisher

If any hot work is to be conducted on the refrigeration equipment or any associated parts, appropriate fire extinguishing equipment shall be available to hand. Have a dry powder or CO₂ fire extinguisher adjacent to the charging area.

■ No ignition sources

All possible ignition sources, including cigarette smoking, should be kept sufficiently far away from the site of installation, repairing, removing and disposal, during which refrigerant can possibly be released to the surrounding space. Prior to work taking place, the area around the equipment is to be surveyed to make sure that there are no flammable hazards or ignition risks. "No Smoking" signs shall be displayed.

■ Ventilated area

Ensure that the area is in the open or that it is adequately ventilated before breaking into the system or conducting any hot work. A degree of ventilation shall continue during the period that the work is carried out. The ventilation should safely disperse any released refrigerant and preferably expel it externally into the atmosphere

■ Checks to the refrigeration equipment

Where electrical components are being changed, they shall be fit for the purpose and to the correct specification. At all times the manufacturer's maintenance and service guidelines shall be followed. If in doubt, consult the manufacturer's technical department for assistance.

The following checks shall be applied to installations using FLAMMABLE REFRIGERANTS:

- the charge size is in accordance with the room size within which the refrigerant containing parts are installed;
- the ventilation machinery and outlets are operating adequately and are not obstructed;
- if an indirect refrigerating circuit is being used, the secondary circuit shall be checked for the presence of refrigerant;
- marking to the equipment continues to be visible and legible. Markings and signs that are illegible shall be corrected;
- refrigeration pipe or components are installed in a position where they are unlikely to be exposed to any substance which may corrode refrigerant containing components, unless the components are constructed of materials which are inherently resistant to being corroded or are suitably protected against being so corroded.

■ Checks to electrical devices

Repair and maintenance to electrical components shall include initial safety checks and component inspection procedures. If a fault exists that could compromise safety, then no electrical supply shall be connected to the circuit until it is satisfactorily dealt with. If the fault cannot be corrected immediately but it is necessary to continue operation, an adequate temporary solution shall be used. This shall be reported to the owner of the equipment so all parties are advised.

Initial safety checks shall include:

- that capacitors are discharged: this shall be done in a safe manner to avoid possibility of sparking;
- that no live electrical components and wiring are exposed while charging, recovering or purging the system;
- that there is continuity of earth bonding.

■ Repairs to sealed components

During repairs to sealed components, all electrical supplies shall be disconnected from the equipment being worked upon prior to any removal of sealed covers, etc. If it is absolutely necessary to have an electrical supply to equipment during servicing,

then a permanently operating form of leak detection shall be located at the most critical point to warn of a potentially hazardous situation.

Particular attention shall be paid to the following to ensure that by working on electrical components, the casing is not altered in such a way that the level of protection is affected. This shall include damage to cables, excessive number of connections, terminals not made to original specification, damage to seals, incorrect fitting of glands, etc.

Ensure that the apparatus is mounted securely.

Ensure that seals or sealing materials have not degraded to the point that they no longer serve the purpose of preventing the ingress of flammable atmospheres.

Replacement parts shall be in accordance with the manufacturer's specifications.

■ **Repair to intrinsically safe components**

Do not apply any permanent inductive or capacitance loads to the circuit without ensuring that this will not exceed the permissible voltage and current permitted for the equipment in use. Intrinsically safe components are the only types that can be worked on while live in the presence of a flammable atmosphere. The test apparatus shall be at the correct rating. Replace components only with parts specified by the manufacturer. Other parts may result in the ignition of refrigerant in the atmosphere from a leak.

■ **Cabling**

Check that cabling will not be subject to wear, corrosion, excessive pressure, vibration, sharp edges or any other adverse environmental effects. The check shall also take into account the effects of aging or continual vibration from sources such as compressors or fans.

■ **Detection of flammable refrigerants**

Under no circumstances shall potential sources of ignition be used in the searching for or detection of refrigerant leaks. A halide torch (or any other detector using a naked flame) shall not be used.

■ **Leak detection methods**

The following leak detection methods are deemed acceptable for all refrigerant systems. Electronic leak detectors may be used to detect refrigerant leaks but, in the case of FLAMMABLE REFRIGERANTS, the sensitivity may not be adequate, or may need re-calibration. (Detection equipment shall be calibrated in a refrigerant-free area.) Ensure that the detector is not a potential source of ignition and is suitable for the refrigerant used. Leak detection equipment shall be set at a percentage of the LFL of the refrigerant and shall be calibrated to the refrigerant employed, and the appropriate percentage of gas (25 % maximum) is confirmed.

Leak detection fluids are suitable for use with most refrigerants but the use of detergents containing chlorine shall be avoided as the chlorine may react with the refrigerant and corrode the copper pipe-work.

If a leak is suspected, all naked flames shall be removed/extinguished.

If a leakage of refrigerant is found which requires brazing, all of the refrigerant shall be recovered from the system, or isolated (by means of shut off valves) in a part of the system remote from the leak. For appliances containing FLAMMABLE REFRIGERANTS, oxygen free nitrogen (OFN) shall then be purged through the system both before and during the brazing process.

■ Removal and evacuation

When breaking into the refrigerant circuit to make repairs – or for any other purpose – conventional procedures shall be used. However, for flammable refrigerants it is important that the best practice is followed since flammability is a consideration. Opening of the refrigeration systems shall not be done by brazing. The following procedure shall be adhered to:

- remove refrigerant;
- purge the circuit with inert gas;
- evacuate;
- purge again with inert gas;
- open the circuit by cutting or brazing.

The refrigerant charge shall be recovered into the correct recovery cylinders. For appliances containing FLAMMABLE REFRIGERANTS, the system shall be “flushed” with OFN to render the unit safe. This process may need to be repeated several times. Compressed air or oxygen shall not be used for purging refrigerant systems.

For appliances containing FLAMMABLE REFRIGERANTS, flushing shall be achieved by breaking the vacuum in the system with OFN and continuing to fill until the working pressure is achieved, then venting to atmosphere, and finally pulling down to a vacuum. This process shall be repeated until no refrigerant is within the system. When the final OFN charge is used, the system shall be vented down to atmospheric pressure to enable work to take place. This operation is absolutely vital if brazing operations on the pipe-work are to take place.

Ensure that the outlet for the vacuum pump is not close to any ignition sources and that ventilation is available.

■ Charging procedures

In addition to conventional charging procedures, the following requirements shall be followed.

- Ensure that contamination of different refrigerants does not occur when using charging equipment. Hoses or lines shall be as short as possible to minimise the amount of refrigerant contained in them.

- Cylinders shall be kept upright.
- Ensure that the refrigeration system is earthed prior to charging the system with refrigerant.
- Label the system when charging is complete (if not already).
- Extreme care shall be taken not to overfill the refrigeration system.

Prior to recharging the system, it shall be pressure-tested with the appropriate purging gas. The system shall be leak-tested on completion of charging but prior to commissioning. A follow up leak test shall be carried out prior to leaving the site.

■ Decommissioning

Before carrying out this procedure, it is essential that the technician is completely familiar with the equipment and all its detail. It is recommended good practice that all refrigerants are recovered safely.

Prior to the task being carried out, an oil and refrigerant sample shall be taken in case analysis is required prior to re-use of reclaimed refrigerant. It is essential that electrical power is available before the task is commenced.

- (a) Become familiar with the equipment and its operation.
- (b) Isolate system electrically.
- (c) Before attempting the procedure, ensure that:
 - mechanical handling equipment is available, if required, for handling refrigerant cylinders;
 - all personal protective equipment is available and being used correctly;
 - the recovery process is supervised at all times by a competent person;
 - recovery equipment and cylinders conform to the appropriate standards.
- (d) Pump down refrigerant system, if possible.
- (e) If a vacuum is not possible, make a manifold so that refrigerant can be removed from various parts of the system.
- (f) Make sure that cylinder is situated on the scales before recovery takes place.
- (g) Start the recovery machine and operate in accordance with manufacturer's instructions.
- (h) Do not overfill cylinders. (No more than 80 % volume liquid charge).
- (i) Do not exceed the maximum working pressure of the cylinder, even temporarily.
- (j) When the cylinders have been filled correctly and the process completed, make sure that the cylinders and the equipment are removed from site promptly and all isolation valves on the equipment are closed off.
- (k) Recovered refrigerant shall not be charged into another refrigeration system unless it has been cleaned and checked.

■ Labelling

Equipment shall be labelled stating that it has been de-commissioned and emptied of refrigerant. The label shall be dated and signed. For appliances containing

FLAMMABLE REFRIGERANTS, ensure that there are labels on the equipment stating the equipment contains flammable refrigerant.

■ Recovery

When removing refrigerant from a system, either for servicing or decommissioning, it is recommended good practice that all refrigerants are removed safely.

When transferring refrigerant into cylinders, ensure that only appropriate refrigerant recovery cylinders are employed. Ensure that the correct number of cylinders for holding the total system charge are available.

All cylinders to be used are designated for the recovered refrigerant and labelled for that refrigerant (i.e. special cylinders for the recovery of refrigerant). Cylinders shall be complete with pressure-relief valve and associated shut-off valves in good working order. Empty recovery cylinders are evacuated and, if possible, cooled before recovery occurs.

The recovery equipment shall be in good working order with a set of instructions concerning the equipment that is at hand and shall be suitable for the recovery of all appropriate refrigerants including, when applicable, FLAMMABLE REFRIGERANTS. In addition, a set of calibrated weighing scales shall be available and in good working order. Hoses shall be complete with leak-free disconnect couplings and in good condition. Before using the recovery machine, check that it is in satisfactory working order, has been properly maintained and that any associated electrical components are sealed to prevent ignition in the event of a refrigerant release. Consult manufacturer if in doubt.

The recovered refrigerant shall be returned to the refrigerant supplier in the correct recovery cylinder, and the relevant waste transfer note arranged. Do not mix refrigerants in recovery units and especially not in cylinders.

If compressors or compressor oils are to be removed, ensure that they have been evacuated to an acceptable level to make certain that flammable refrigerant does not remain within the lubricant. The evacuation process shall be carried out prior to returning the compressor to the suppliers. Only electric heating to the compressor body shall be employed to accelerate this process. When oil is drained from a system, it shall be carried out safely.

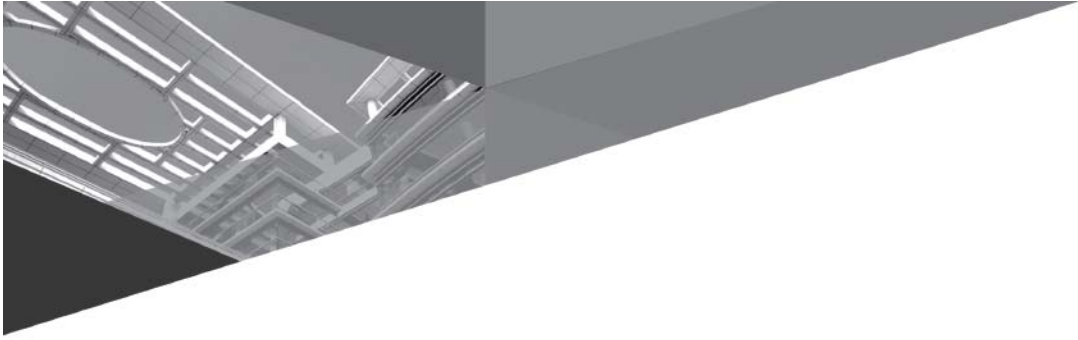

GREE ELECTRIC APPLIANCES, INC. OF ZHUHAI

Add: West Jinji Rd, Qianshan, Zhuhai, Guangdong, China, 519070

Tel: (+86-756) 8522218

Fax: (+86-756) 8669426

E-mail: global@cn.gree.com

Web: www.gree.com



600005062114