



Owner's Manual

Original Instructions

Window Type Air Conditioner

Thank you for choosing our product.

Please read this Owner's Manual carefully before operation and retain it for future reference.

If you have lost the Owner's Manual, please contact the local agent or visit www.gree.com or send an email to global@cn.gree.com for the electronic version.

GJC05BT-A6NMNC4A
GJC05BT-A6NRNC4A
GJC05BT-A6NRND1A
GJC05BT-A6NMND1A
GJC06BT-A6NMNC4A
GJC06BT-A6NRNC4A
GJC06BT-A6NRND1A
GJC06BT-A6NMND1A

TABLE OF CONTENTS

The Refrigerant	1
Safety Precautions	3
Precautions	6
Preparation before Installation	8
Installation Procedure	9
Air Conditioner Use	15
Troubleshooting	20
Assistance or Service	21
Safety Operation of Flammable Refrigerant	22
Safety Notices for Maintenance	24
Information on Servicing	26

READ THIS MANUAL

Inside you will find many helpful hints on how to use and maintain your air conditioner properly. Just a little preventive care on your part can save you a great deal of time and money over the life of your air conditioner. You'll find many answers to common problems in the chart of troubleshooting tips. If you review our chart of Troubleshooting Tips first, you may not need to call for service at all.

CAUTION

Contact the authorized service technician for repair or maintenance of this unit.

Contact the installer for installation of this unit.

The air conditioner is not intended for use by young children or infirm persons without supervision.

Young children should be supervised to ensure that they do not play with the air conditioner.

If the SUPPLY CORD is damaged, it must be replaced by the manufacturer, its service agent or similarly qualified persons in order to avoid a hazard.

Installation work must be performed in accordance with the national wiring standards by authorized personnel only.

This appliance is not intended for use by persons (including children) with reduced physical, sensory or mental capabilities or lack of experience and knowledge, unless they have been given supervision or instruction concerning use of the appliance by a person responsible for their safety. Children should be supervised to ensure they are away from the appliance.

This appliance can be used by children aged from 8 years and above and persons with reduced physical, sensory or mental capabilities or lack of experience and knowledge if they have been given supervision or instruction concerning use of the appliance in a safe way and understand the hazards involved.

Children shall not play with the appliance.

Cleaning and user maintenance shall not be made by children without supervision.

When refrigerant leaks or requires discharge during installation, maintenance, or disassembly, it should be handled by certified professionals or otherwise in compliance with local laws and regulations.

Please read this operating manual carefully before operating the unit.



Caution, risk of fire.



Before use the appliance, read the owner's manual first.



Before install the appliance, read the installation manual first.



Before repair the appliance, read the service manual first.

The figures in this manual may be different with the material objects, please refer to the material objects for reference.

The Refrigerant

- To realize the function of the air conditioner unit, a special refrigerant circulates in the system. The used refrigerant is the fluoride R32, which is specially cleaned. The refrigerant is flammable and inodorous. Furthermore, it can lead to explosion under certain conditions. But the flammability of the refrigerant is very low. It can be ignited only by fire.
- Compared to common refrigerants, R32 is a nonpolluting refrigerant with no harm to the ozonosphere. The influence upon the greenhouse effect is also lower. R32 has got very good thermodynamic features which lead to a really high energy efficiency. The units therefore need a less filling.

WARNING:

Keep ventilation openings, in the appliance enclosure or in the built-in structure, clear of Obstruction.

Do not use means to accelerate the defrosting process or to clean, other than those recommended by the manufacture. Should repair be necessary, contact your nearest authorized Service Centre.

Any repairs carried out by unqualified personnel may be dangerous.

Do not pierce or burn.

Appliance shall be installed, operated and stored in a room with a floor area larger than Xm^2 . (Please refer to table "a" in section of " Safety Operation of Flammable Refrigerant " for Space X.)

Appliance filled with flammable gas R32. For repairs, strictly follow manufacturer's instructions only.

Be aware that refrigerants may not contain an odour.

Read specialist's manual.

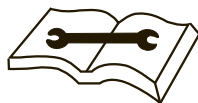
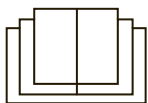

The Refrigerant



WARNING:

Do not use means to accelerate the defrosting process or to clean, other than those recommended by the manufacturer.

The appliance shall be stored in a room without continuously operating ignition sources (for example: open flames, an operating gas appliance or an operating electric heater.)

Do not pierce or burn. Be aware that refrigerants may not contain an odor.

Adopt R32 flammable refrigerant. When maintaining or disposing the unit, the refrigerant inside the system must be eliminated. Refrigerant should be recovered, which can't be discharged freely.

Keep ventilation opening clear of obstruction.

The unit can only be maintained according to the method suggested by manufacturer. Appliance shall be stored in a room without continuously operating open flames (for example an operating gas appliance) and ignition sources (for example an operating electric heater) close to the appliance. No open fire (fired equipment such as electrical heater and gas stove etc.) or any equipment (e.g. switch) that might generate arc around the appliance.

The appliance shall be stored so as to prevent mechanical damage from occurring.



NOTE:

Any person who is involved with working on or breaking into a refrigerant circuit should hold a current valid certificate from an industry-accredited assessment authority, which authorizes their competence to handle refrigerants safely in accordance with an industry recognized assessment specification.



Servicing shall only be performed as recommended by the equipment manufacturer. Maintenance and repair requiring the assistance of other skilled personnel shall be carried out under the supervision of the person competent in the use of flammable refrigerants.

Safety Precautions

















To prevent injury to the user or other people and property damage, the following instructions must be followed. Incorrect operation due to ignoring of instructions may cause harm or damage. The seriousness is classified by the following indications.

 WARNING	This symbol indicates the possibility of death or serious injury.
 CAUTION	This symbol indicates the possibility of injury or damage to property.

- Meaning of symbols used in this manual are as shown below.

	NEVER DO THIS.
	ALWAYS DO THIS.

WARNING

- | | | |
|---|---|--|
|  Plug in power plug properly |  Do not operate or stop the unit by inserting or pulling out the power plug. |  Do not damage or use an unspecified power cord. |
| ● Otherwise, it may cause electric shock or fire due to excess heat generation. | ● It may cause electric shock or fire due to heat generation. | ● If the power cord is damaged, it must be replaced by the manufacturer or an authorized service center in order to avoid hazard. |
|  Do not modify power cord length or share the outlet with other appliances. |  Do not operate with wet hands or in damp environment. |  Do not direct airflow at room occupants only. |
| ● It may cause electric shock or fire due to heat generation. | ● It may cause electric shock. | ● This could damage your health. |
|  Always ensure effective grounding. |  Do not allow water to run into electric parts. |  Always install circuit breaker and a dedicated power circuit. |
| ● Incorrect grounding may cause electric shock. | ● It may cause failure of machine or electric shock. | ● Incorrect installation may cause fire and electric shock. |
|  Unplug the unit if strange sounds, smell, or smoke comes from it. |  Do not use the socket if it is loose or damaged. |  Do not open the unit during operation. |
| ● It may cause fire and electric shock. | ● It may cause fire and electric shock. | ● It may cause electric shock. |
|  Keep firearms away. |  Do not use the power cord close to heating appliances. |  Do not use the power cord near flammable gas or combustibles, such as gasoline, benzene, thinner, etc. |
| ● It may cause fire. | ● It may cause fire and electric shock. | ● It may cause an explosion or fire. |
|  Ventilate room before operating air conditioner if there is a gas leakage from another appliance. |  Do not disassemble or modify unit. | |
| ● It may cause explosion, fire and burns. | ● It may cause failure and electric shock. | |

Safety Precautions

⚠ WARNING

- | | | |
|--|--|---|
| <p>⊘ When the air filter is to be removed, do not touch the metal parts of the unit.</p> <ul style="list-style-type: none"> ● It may cause an injury. | <p>⊘ Do not clean the air conditioner with water.</p> <ul style="list-style-type: none"> ● Water may enter the unit and degrade the insulation. It may cause an electric shock. | <p>⚠ Ventilate the room well when used together with a stove, etc.</p> <ul style="list-style-type: none"> ● An oxygen shortage may occur. |
| <p>⚠ When the unit is to be cleaned, switch off, and turn off the circuit breaker.</p> <ul style="list-style-type: none"> ● Do not clean unit when power is on as it may cause fire and electric shock, it may cause an injury. | <p>⊘ Do not put a pet or house plant where it will be exposed to direct air flow.</p> <ul style="list-style-type: none"> ● This could injure the pet or plant. | <p>⊘ Do not use for special purposes.</p> <ul style="list-style-type: none"> ● Do not use this air conditioner to preserve precision devices, food, pets, plants, and art objects. It may cause deterioration of quality, etc. |
| <p>⚠ Stop operation and close the window in storm or hurricane.</p> <ul style="list-style-type: none"> ● Operation with windows opened may cause wetting of indoor and soaking of household furniture. | <p>⊘ Hold the plug by the head of the power plug when taking it out.</p> <ul style="list-style-type: none"> ● It may cause electric shock and damage. | <p>⊘ Turn off the main power switch when not using the unit for a long time.</p> <ul style="list-style-type: none"> ● It may cause failure of product or fire. |
| <p>⚠ Do not place obstacles around air-inlets or inside of air-outlet.</p> <ul style="list-style-type: none"> ● It may cause failure of appliance or accident. | <p>⊘ Ensure that the installation bracket of the outdoor appliance is not damaged due to prolonged exposure.</p> <ul style="list-style-type: none"> ● If bracket is damaged, there is concern of damage due to falling of unit. | <p>⊘ Always insert the filters securely. Clean the filter once every two weeks.</p> <ul style="list-style-type: none"> ● Operation without filters may cause failure. |
| <p>⚠ Do not use strong detergent such as wax or thinner but use a soft cloth.</p> <ul style="list-style-type: none"> ● Appearance may be deteriorated due to change of product color or scratching of its surface. | <p>⊘ Do not place heavy object on the power cord and ensure that the power cord is not compressed.</p> <ul style="list-style-type: none"> ● There is danger of fire or electric shock. | <p>⊘ Do not drink water drained from air conditioner.</p> <ul style="list-style-type: none"> ● It contains contaminants and could make you sick. |
| <p>⚠ Use caution when unpacking and installing. Sharp edges could cause injury.</p> | <p>⊘ If water enters the unit, turn the unit off at the power outlet and switch off the circuit breaker. Isolate supply by taking the power plug out and contact a qualified service technician.</p> | |

Safety Precautions

WARNING! The power supply cord with this air conditioner contains a current detection device designed to reduce the risk of fire. Please refer to the section, Operation of Current Device, for details. In the event that the power supply cord is damaged, it cannot be repaired-it must be replaced with a cord from the Product Manufacturer.

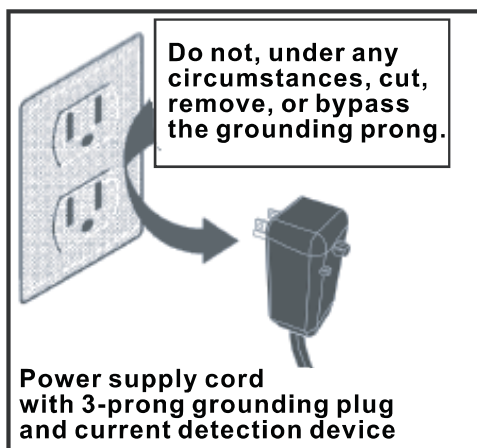

⚠WARNING For your safety

- Do not store or use gasoline or other flammable vapors and liquids in the vicinity of this or any other appliance.
- Avoid fire hazard or electric shock. Do not use an extension cord or an adaptor plug. Do not remove any prong from the power cord.

⚠WARNING Electrical Information

- Be sure the electrical service is adequate for the model you have chosen. This information can be found on the serial plate, which is located on the side of the cabinet and behind the grille.
 - Be sure the air conditioner is properly grounded. To minimize shock and fire hazards, proper grounding is important. The power cord is equipped with a three-prong grounding plug for protection against shock hazards.
 - Your air conditioner must be used in a properly grounded wall receptacle. If the wall receptacle you intend to use is not adequately grounded or protected by a time delay fuse or circuit breaker, have a qualified electrician install the proper receptacle.
 - Ensure the receptacle is accessible after the unit installation.
 - Do not run air conditioner without side protective cover in place. This could result in mechanical damage within the air conditioner.
- Do not use an extension cord or an adaptor plug.**

Operation of Current Device

The power supply cord contains a current device that senses damage to the power cord. To test your power supply cord do the following:

1. Plug in the Air Conditioner.
2. The power supply cord will have TWO buttons on the plug head. Press the TEST button, you will notice a click as the RESET button pops out.
3. Press the RESET button, again you will notice a click as the button engages.
4. The power supply cord is now supplying electricity to the unit. (On some products this is also indicated by a light on the plug head.)

NOTICE

- Do not use this device to turn the unit on or off.
- Always make sure the RESET button is pushed in for correct operation.
- The power supply must be replaced if it fails reset when either the TEST button is pushed, or it cannot be reset. Please contact Customer Service.
- If power supply cord is damaged, it cannot be repaired. It MUST be replaced with a new cord - please contact Customer Service.

Precautions

⚠️ WARNING

- Air Conditioner should be properly grounded. Incorrect grounding may cause electric shock.
- Do not connect air conditioner to multipurpose socket. Otherwise, it may cause fire hazard.
- Do install the air switch. If not, it may cause malfunction.
- Do not spill water on the remote controller, otherwise the remote controller may be broken.
- Do not spray water on air conditioner. It may cause electric shock or malfunction.
- Do not extend fingers or objects into air inlet or air outlet. It may cause personal injury or damage.
- Do not step on air conditioner, or put heavy objects. It may cause damage or personal injury.
- Do not block air outlet or air inlet. It may cause malfunction.
- Do disconnect power supply when cleaning air conditioner. Otherwise, it may cause electric shock.
- Do not repair air conditioner by yourself. It may cause electric shock or damage. Please contact dealer when you need to repair air conditioner.
- Maintenance must be performed by qualified professionals. Otherwise, it may cause personal injury or damage.

Note:

The power cord of window type unit has creepage protection device. There're test button and reset button on the plug. You are suggested to check the power cord periodically.

Check method:

After putting through the power, indicator is ON. After pressing test button, indicator is OFF and you can heard a sound. Then press reset button, indicator will be ON, which indicates the protection device is normal.

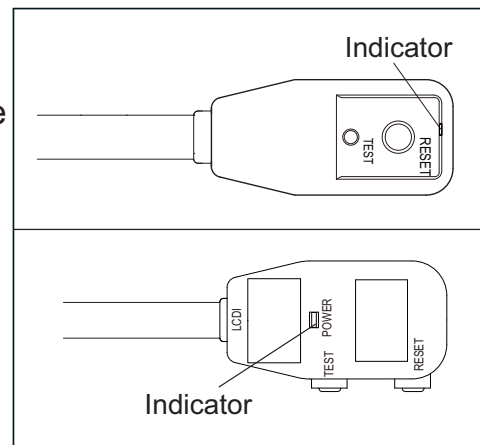

Note: Plug may be different with the actual product. Please refer to actual product.

Working temperature range

※ Operating Temperature Range		
	Indoor side DB/WB(°C/°F)	Outdoor side DB/WB(°C/°F)
Maximum cooling	40°C(104°F)/26.7°C(80°F)	40°C(104°F)/26.7°C(80°F)

The operating temperature range (outdoor temperature) for cooling only unit is 18°C~ 40°C(64 ~ 104°F).

Precautions

Requirements for Electric Connection

Safety precaution









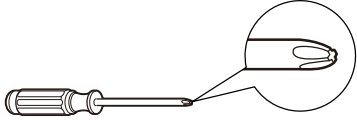

1. Must follow the electric safety regulations when installing the unit.
2. According to the local safety regulations, use qualified power supply circuit and air switch.
3. Make sure the power supply matches with the requirement of air conditioner. Unstable power supply or incorrect wiring may result in electric shock, fire hazard or malfunction.
4. Please make sure the power supply complies with the requirement of air conditioner. Unstable power supply or wrong wiring may lead to electric shock, fire hazard or malfunction.
5. Properly connect the live wire, neutral wire and grounding wire of power socket.
6. Be sure to cut off the power supply before proceeding any work related to electricity and safety.
7. Do not put through the power before finishing installation.
8. The air conditioner is first class electric appliance. It must be properly grounding with specialized grounding device by a professional. Please make sure it is always grounded effectively, otherwise it may cause electric shock.
9. The yellow-green wire or green wire in air conditioner is grounding wire, which can't be used for other purposes.
10. The grounding resistance should comply with national electric safety regulations.

Electric wiring

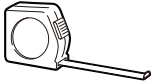
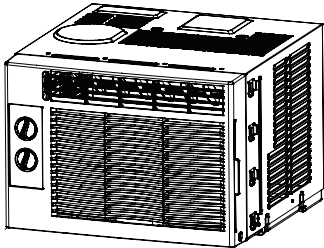
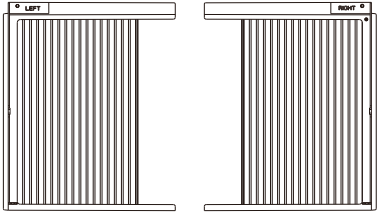
- Must connect with ground reliably.
- The exclusive circuit must be used. But removable socket can't be used because poor contact of it can cause over heat or fire.
- Don't pull the power cord strongly.
- Connecting method between air conditioners and power cord and interconnecting method of each individual element with one another should accord with wiring diagram on the unit.
- The air conditioner should be installed in accordance with national wiring regulation.
- An all-pole disconnection switch having a contact separation of at least 3mm in all poles should be connected in fixed wiring.
- Air switch (thermal-magnetic breaker) should be installed in the circuit.

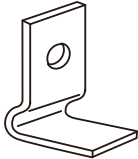
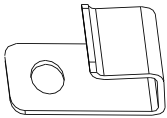
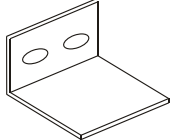
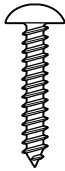

Preparation before Installation

Tools for installation				
	Phillips screwdriver		Screwdriver	
				
	Level bar	Scissors	Pencil	Measuring tape
Products and spare parts list				
	Window type unit		Flexible screen	
				
	Sealing strip (with adhesive)	Sealing strip (without adhesive)	Weather seals (5)	
				
	Lock frame(2) (For wooden windows)	Lock frame(2) (For Vinyl-Clad windows)	Sash lock	
				
	Screws(7)		Owner's manual	

Installation Procedure

Location

How to install:

- Choose a location where there are no any obstacle surrounding the unit, and the plug is accessible.
- Choose the installation space according to the following diagram.

The distance between the air conditioner and the around obstacles should meet the requirement as below: over 300mm (upper side), over 500mm (left side), over 500mm (right side), over 1500mm (front side) and over 500mm (rear side).

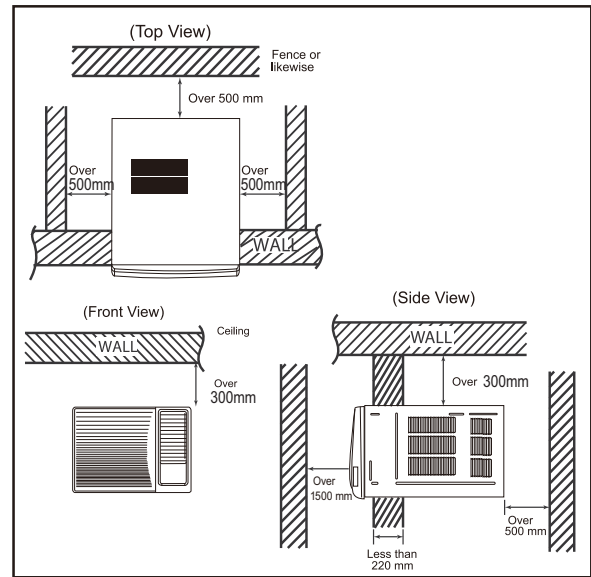

Left + right filler panel assembly

Note: Top Rail and Side Panels at each side are offset to provide the proper pitch to the rear of (5/16"). This is necessary for proper condensed water utilization and drainage. If you are not using the Side Panels for any reason, this pitch to the rear must be maintained!

Step 1:

Place unit on floor, a bench or a table. There is a Left and Right side Filler Panels - be sure to use the proper panel for each side. When installed, the flange for securing the panel in place to the window sill will be facing into the room.

A. Hold the side Panel in one hand and gently pull back the center to free the open end. See FIG. 1.

B. Slide the free end "T" section of the panel directly into the cabinet as shown in FIG. 2. Slide the panel down. Be sure to leave enough space to slip the top and bottom of the frame into the rails on the cabinet.

C. Once the panel has been installed on the side of the cabinet, make sure it sits securely inside the frame channel by making slight adjustments. Slide the top and bottom ends of the frame into the top and bottom rails of the cabinet. See FIG. 3.

D. Slide the panel all the way in and repeat on the other side.

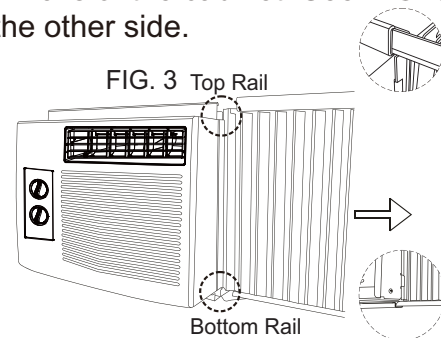
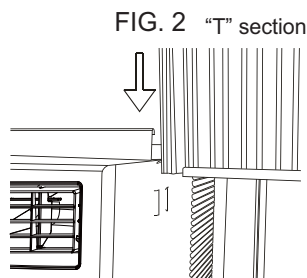
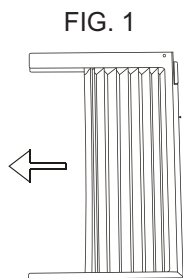

Installation Procedure

Your air conditioner is designed to install in standard double hung windows with opening widths of 22" to 36" (FIG. 4A , FIG. 4B) Lower sash must open sufficiently to allow a clear vertical opening of 15 ½" min. Side louvers and the rear of the air conditioner must have clear air space to allow enough airflow through the condenser, for heat removal. The rear of the unit must be outdoors, not inside a building or garage.

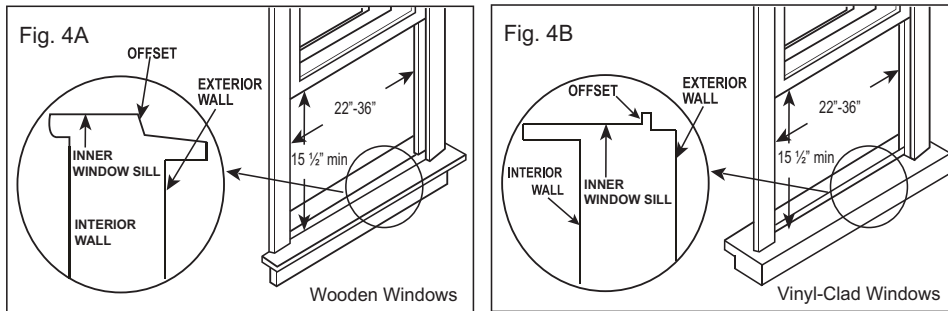

Step 2: Weather-proof type window:

The height of window frame is higher than windowsill for some weather-proof type window, which will affect the installation of air conditioner. In this case, before installing the air conditioner, add wooden strap on the windowsill, and fix the wooden strap at the windowsill.

Specification of wooden strap:

Width: about 2"

Length: same to the inner frame size of window

Height: Put the wooden strap on the windowsill, top part of wooden strap and window frame should be at the same horizontal level, or higher than the top part of window frame for about 1/2".

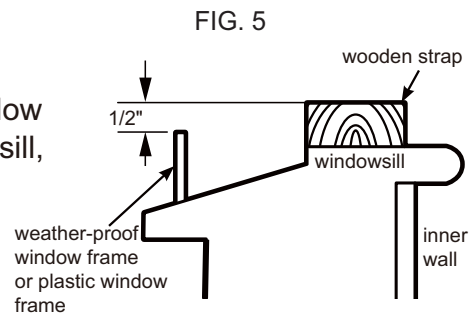

Step 3: Stick sealing strip

Cut the sealing strip into proper length. Tear off the paster and then stick the sealing strip at the lower part of the window frame.

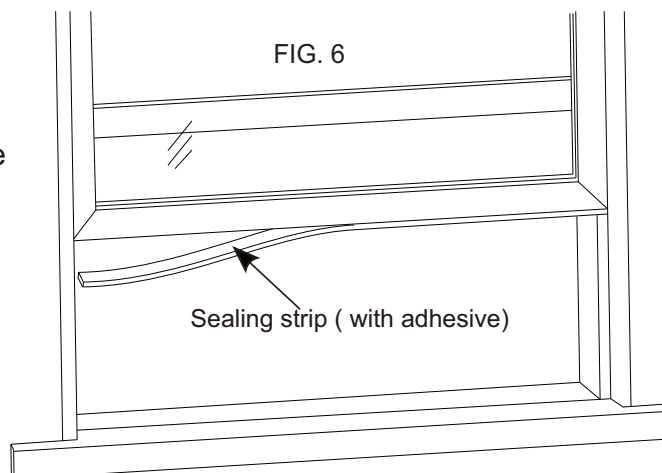

Installation Procedure

Step 4:

Keep a firm grip on the air conditioner, carefully place the unit into the window opening so the bottom of the air conditioner frame is against the window sill (FIG. 7 A & FIG. 7B). Carefully close the window behind the top rail of the unit.

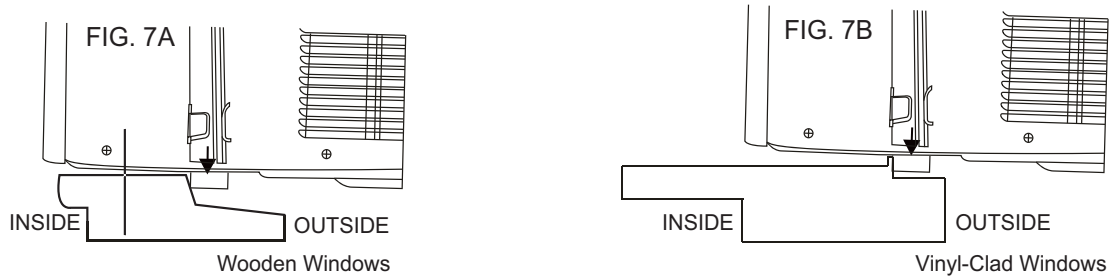

Step 5:

Extend the side panels out against the window frame (FIG. 8A for wooden windows), (FIG. 8B for Vinyl-Clad windows).

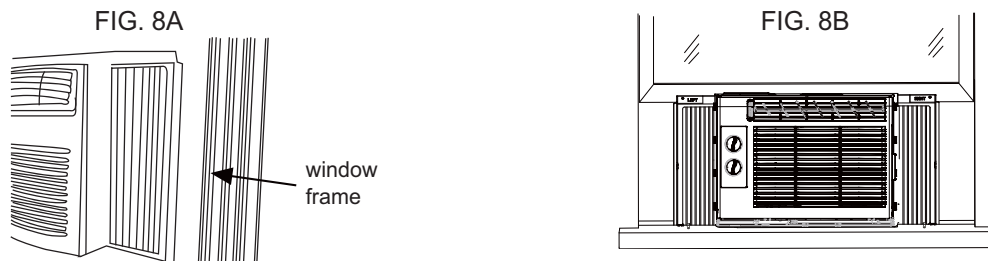

Step 6:

Place the frame lock between the frame extensions and the window sill as shown (FIG. 9A for wooden windows), (FIG. 9B for Vinyl-Clad windows).

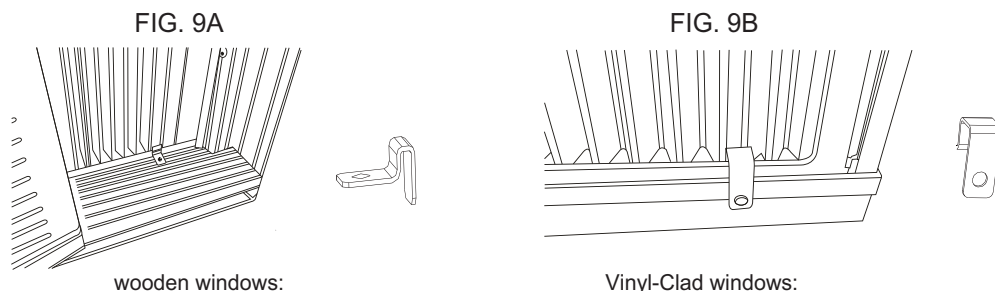

Step 7: Drive locking screws

A: For wooden windows:

Drive locking screws through the frame lock and into the sill (FIG. 10A).

NOTE:

To prevent window sill from splitting, drill 1/8" (3mm) pilot holes before driving screws. Drive locking screws through frame holes into window sash (FIG.10B)

B: For Vinyl-Clad windows:

Drive locking screws through the frame lock and into the window sash (FIG.10B).

Installation Procedure

NOTE:

Before driving the screws, use a drill to drill 5 holes through the holes in the frame lock and frame extensions into the window sash as shown (FIG.10B).

FIG. 10A

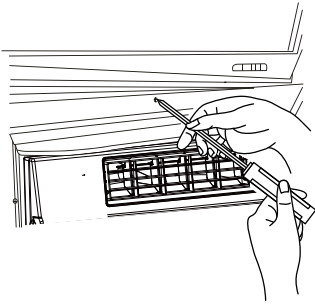
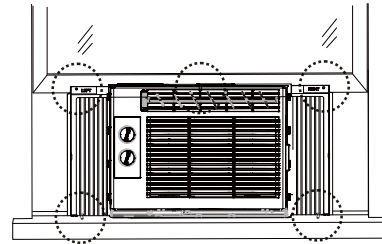

FIG. 10B



Step 8:

To secure lower sash in place, attach right angle sash lock with screw as shown (FIG.11).

NOTE: It is difficult to lock the windows with the sash lock for Vinyl-Clad windows, so you can use lock by window itself.

Step 9:

Cut the sealing strip into the length same to the width of window. Plug the sealing strip between glasses and window to prevent rain and insects getting into the room. (FIG. 12).

Note: If sealing strip is not proper to your window, you can select other proper to replace it.

FIG. 11

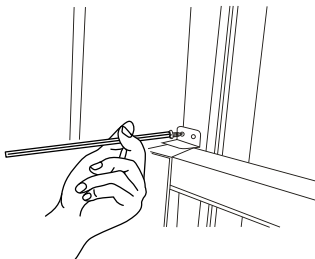
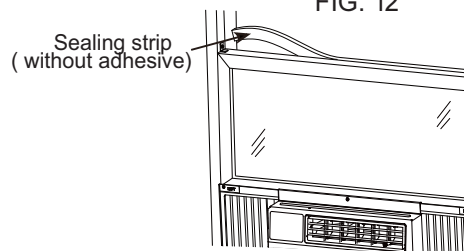

FIG. 12



Installation Procedure

Step 10:

Check that air conditioner is tilted back about 1/4" to 1/2" (tilted about 2° to 4° downward to the outside, see FIG. 13A & FIG. 13B). After proper installation, condensate should not drain from the overflow drain hole during normal use, correct the slope otherwise.

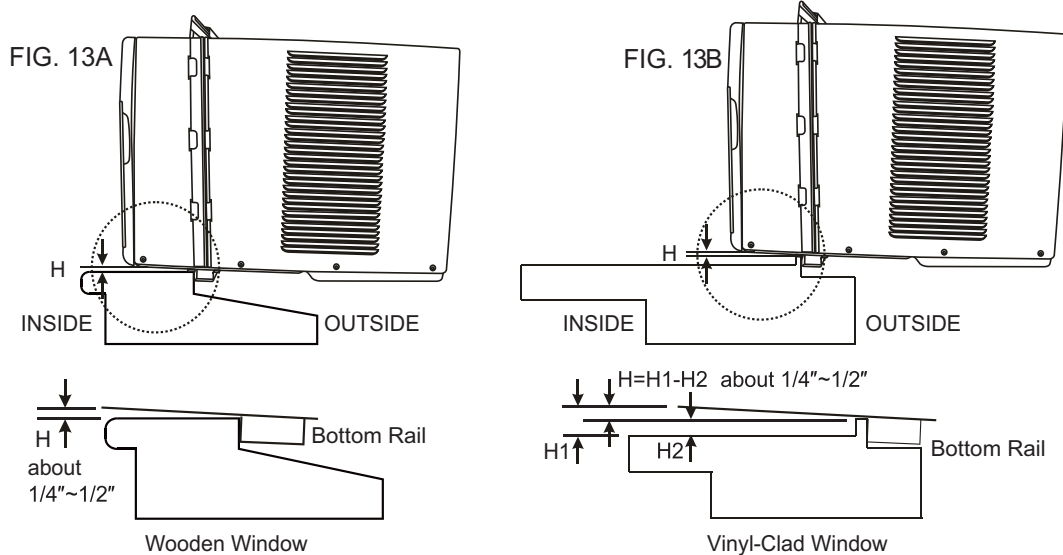

Step 11:

Trim the weather seal with a proper length peel off the protective backing and plug any gaps if needed as shown FIG. 14.

Removing the air conditioner From Window

- * Turn the air conditioner off, and disconnect power cord.
- * Remove sash seal from between windows, and unscrew sash lock. Remove screws installed through frame and frame lock.
- * Close (slide) side panels into frame.

Keeping a firm grip on air conditioner, raise sash and carefully remove. Be careful not to spill any condensate water while lifting unit from window. Store parts WITH air conditioner.

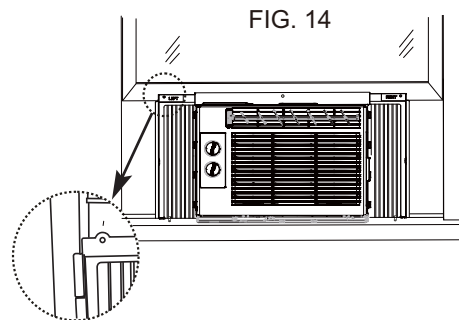

Installation Procedure

Step 12: Drain water

To get the maximum cooling efficiency , the air conditioner is designed to splash the condensate on the condenser coil. If the splashing sound annoys you, you can provide an outside drain by using the following procedure, which may however cause a small loss of performance.

1. The air conditioner have the drainage gasket-FIG. 15A.
2. Remove the drainage gasket from the body base plate- FIG. 15B.

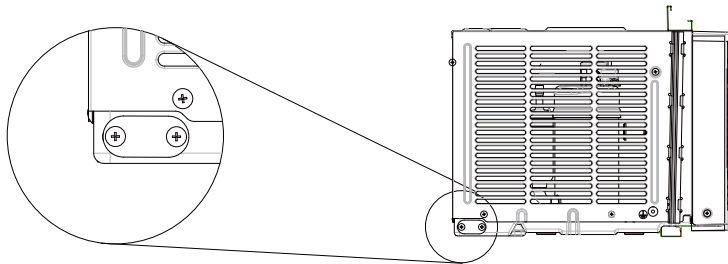

FIG. 15A

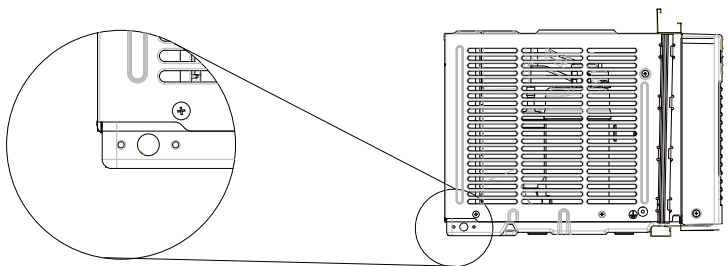

FIG. 15B

Air Conditioner Use

Operating your air conditioner properly helps you to obtain the best possible results.

This section explains proper air conditioner operation.

IMPORTANT:

- If you turn off the air conditioner, wait at least 3 minutes before turning it back on. This prevents the air conditioner from blowing a fuse or tripping a circuit breaker.
- Do not try to operate your air conditioner in the cooling mode when outside temperature is below 65°F (18°C). The inside evaporator coil will freeze up, and the air conditioner will operate properly.

NOTE: In the event of a power failure, your air conditioner will operate at the previous settings when the power is restored.

Starting Your Air Conditioner— Digital Control

Lights next to the touch pads on the air conditioner control panel indicate the selected settings.

The display always shows the room temperature except when setting the Set temperature or the Delay timer

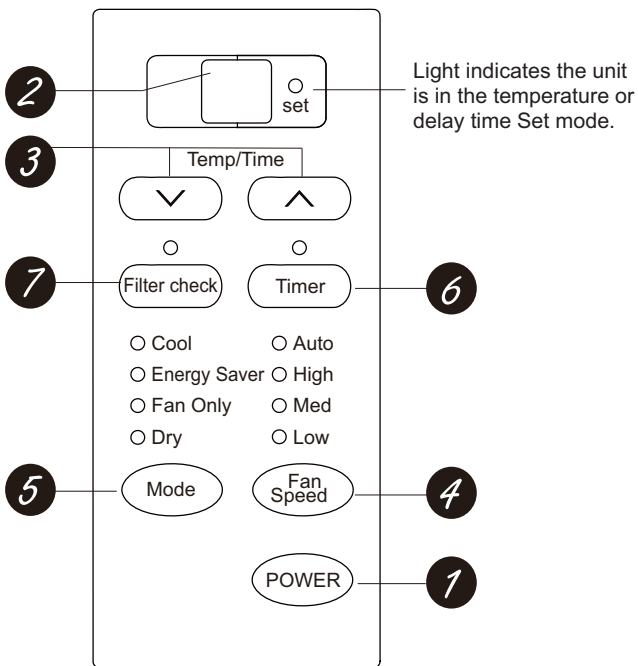

Air Conditioner Controls

Controls

1 Power Pad

Press this button can turn on or turn off air conditioner.

NOTE: Press this button to turn on air conditioner,

the unit will operate in Energy Save mode; if the unit is energized after power failure, the unit will still operate according to the status before power failure.

2 Display

1. Under ON status without timer setting, the operation mode is Auto, Cool, Energy Saver or Dry mode, and the set temperature will be displayed.
2. Under ON status without timer setting, the operation mode is fan mode and the ambient temperature will be displayed.
3. Time will be displayed under timer setting or timer preview.

3 √ / ^ button

Under temperature setting status, after each pressing of “√” or “^” button, temperature will increase or decrease 1°F. Temp setting range: 61-86°F.

Under timer setting status, after each pressing of “√” or “^” button, time will increase or decrease 0.5h or 1h.

4 Fan Speed Pads

Press this button can select your required fan speed in turn. Corresponding speed indicator will be on.

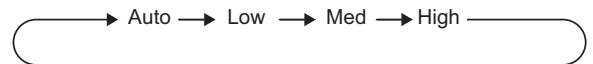

5 Mode Pad

Press this button can your required operation mode in turn. Corresponding indicator will be on.

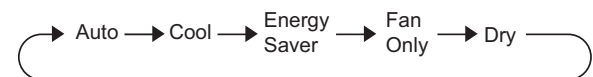

● **Auto:**
Under this mode, the unit will operate automatically according to ex-factory setting. In this case, set temperature cannot be adjusted.

● **Cool:**
Under this mode, air conditioner operates under cooling mode. Cooling indicator will be on. Press “Fan Speed” button can adjust the fan speed.

● **Energy Save:**
Under this mode, air conditioner operates under SE mode. SE indicator will be on. Press “Fan Speed” button can adjust the fan speed.

● **Fan Only:**
Under this mode, air conditioner will not cool or heat, only blow wind. Fan indicator will be on. Press “Fan Speed” button can adjust the fan speed. (No auto fan speed under fan mode)

● **Dry:**
Under this mode, the unit runs in low fan speed for

Air Conditioner Use

dehumidification and the corresponding indicator is on; under dry mode, the fan speed cannot be adjusted.

6 Timer Pad

Timer ON: Can be set under off state of unit. If timer ON reaches, the system will run under Energy Save mode. The setting range is 0.5~24hr.

Timer OFF: Can be set under on state of unit. If timer OFF reaches, the unit will turn off. The timer can be set in 0.5 hour increment below 10 hours and in 1 hour increment for 10 hours or above.

7 Filter check Pad

After fan rotates for 250h totally, lamp of cleaning filter is on to remind customer clean it.

NOTE: When user cleaned the filter, press Filter check button to clear the operation time. Meanwhile, the warning indicator will turn off.

Function introduction for combination buttons

Temperature display switchover function

Press "∨" button and "∧" button simultaneously for 3 seconds can switch between °C and °F

Remote Control



Remote Control

1 ON/OFF :

Press this button to turn on the unit. Press this button again to turn off the unit.

2 MODE :

Each time you press the button, a mode is selected in a sequence that goes from AUTO, COOL, SAVE FAN, and DRY , as the following:



3 - :

Press this button to decrease set temperature. Holding it down above 2 seconds rapidly decreases set temperature. In AUTO mode, set temperature is not adjustable.

4 + :

Press this button to increase set temperature. Holding it down above 2 seconds rapidly increases set temperature. In AUTO mode, set temperature is not adjustable.

5 FAN :

This button is used for setting Fan Speed in the sequence that goes from AUTO, , , , to , then back to Auto.



NOTE: There are 3 speeds for the Fan Speed of this model.

6 I FEEL :

I feel function will be action if pressing this button. If controller receives I FEEL order, it will work under ambient temperature value which sending by remote controller, and remote controller will send ambient temperature value to controller every 10min. After 11min, if controller does not receive ambient temperature value which sending by remote controller, it will run with AC ambient temperature; if I FEEL is not set, ambient temperature will adopt sampling value of AC temperature sensor. If power off happens, this function will not be memorized.

7 SLEEP :

Press this button to go into the SLEEP operation mode. Press it again to cancel this function. This function is available in COOL, or DRY mode to maintain the most comfortable temperature for you.

8 TIMER :

Press this button to initiate auto-on/auto-off timer. To cancel auto-timer program, press this button twice.

9 Combination of "+" and "-" buttons: About lock

Press "+" and "-" buttons simultaneously to lock or unlock the keypad. If the remote controller is locked, is displayed. In this case, pressing any button, blinks three times.

10 Combination of "MODE " and "-" buttons:

About switch between fahrenheit and cennigrade. At unit OFF, press "MODE " and "-" buttons simultaneously to switch between °C and °F .

11 About Lamp

Under switch-on or switch-off state, you may hold "+" and "FAN" buttons simultaneously for 3 seconds to set the lamp on or off and send the code. After being energized the lamp is defaulted on.

12 About Energy saving

Under energy saving mode, lamp of energy saving mode is on, and the temperature setting range is 61~86°F (16~30 °C). The buzzer will give out a beep if remote control turbo speed by remote controller, and runs with high speed.

Air Conditioner Use

Replacement of Batteries in Remote Controller

1. Press the mark “” on back cover of batteries box cover for remote controller with fingers as shown in the fig, and then remove the batteries box cover along the arrow direction.
2. Replace with two #7 (AAA 1.5V) dry batteries. Make sure positions for “+” pole and “-” pole are correct.
3. Reinstall batteries box cover.

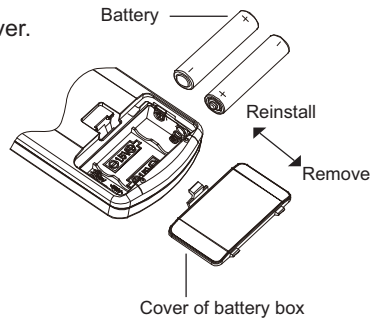

NOTICE

- The distance between signal sender and receiving window should be no more than 8m, and there should be no obstacles between them.
- As the signal will be interfered in the room with electronic fluorescent lamp, conversion fluorescent lamp or wireless phone, please get closer to the air conditioner when using the remote controller.
- Replace new batteries of the same model when replacement is required.
- When you don't use remote controller for a long time, please take out the batteries.

Air Conditioner Use

Air Conditioner Features The controls featured in this manual are representative of many available models. Your model may offer slightly different features.

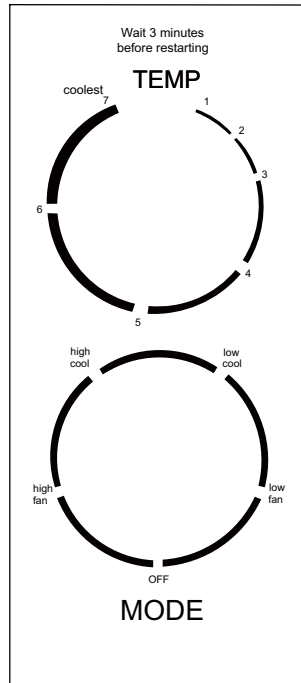

Thermostat

The thermostat is used to set the desired room temperature when the unit is being operated in the “**COOL MODE**”.

To set the desired room temperature, rotate the thermostat switch to the desired setting. After the set temperature is achieved the thermostat will automatically start and stop the compressor in order to maintain the desired set temperature.

Rotate the thermostat selector clockwise for higher cool settings. Higher cool settings will provide lower room temperature.

Rotate the thermostat selector counter clockwise for lower cool settings. Lower cool settings will provide higher room temperature.

Cool Mode

The desired cool setting is selected by rotating the knob to the right to the appropriate location.

“**hi cool**” has maximum cooling effect and airflow.

“**lo cool**” has minimum cooling effect and airflow.

Note: If your unit is equipped with a vent handle, keep it closed for maximum efficiency

Fan Mode

Rotate the knob to the left to select your choice of fan speeds for air circulation.

Note: When selecting a fan speed, the compressor will not run.



Please always wait 3 minutes when turning unit off and then on again, and when changing from cool to fan and back to cool. This prevents the compressor from overheating and possible circuit breaker tripping.



(2-WAY)

AUGER WHEEL

Air Directional Louvers

Air directional louvers control air flow direction. Your air conditioner has the louver type described below.

Auger Type

Rotate the Auger Wheels until the desired Left/Right direction is obtained.

Air Conditioner Use

Care and Cleaning



Clean your air conditioner occasionally to keep it looking new. **Be sure to unplug the unit before cleaning to prevent shock or fire hazards.**

Air Filter Cleaning

The air filter should be checked at least once a month to see if cleaning is necessary. Trapped particles in the filter can build up and cause an accumulation of frost on the cooling coils.

- Remove filter by sliding out from the right-hand side.
- Wash the filter using liquid dishwashing detergent and warm water. Rinse filter thoroughly. Gently shake excess water from the filter. Be sure filter is thoroughly dry before replacing.
- Or, instead of washing you may vacuum the filter clean.

Cabinet Cleaning

- Be sure to unplug the air conditioner to prevent shock or fire hazard. The cabinet and front may be dusted with an oil-free cloth or washed with a cloth dampened in a solution of warm water and mild liquid dishwashing detergent. Rinse thoroughly and wipe dry.
- Never use harsh cleaners, wax or polish on the cabinet front.
- Be sure to wring excess water from the cloth before wiping around the controls. Excess water in or around the controls may cause damage to the air conditioner.
- Plug in air conditioner.

Winter Storage

If you plan to store the air conditioner during the winter, remove it carefully from the window according to the installation instructions. Cover it with plastic or return it to the original carton.

Normal Sounds

When your air conditioner is operating normally, you may hear sounds such as:

- Droplets of water hitting the condenser, causing a pinging or clicking sound. The water droplets help cool the condenser.
- Air movement from the fan.
- Clicks from the thermostat cycle.
- Vibrations or noise due to poor wall or window construction.
- A high-pitched hum or pulsating noise caused by the modern high-efficiency compressor cycling on and off.

Cleaning the Front Panel

1. Unplug air conditioner or disconnect power.
2. Clean front panel with a soft, damp cloth.
3. Air dry front panel completely.
4. Plug in air conditioner or reconnect power.

Repairing Paint Damage

Check once or twice a year for paint damage. This is very important, especially in areas near oceans or where rust is problem. If needed, touch up with a good grade enamel paint.

NOTE: To reduce paint damage during the winter, install a heavy-duty cover over air conditioner cabinet. For information on ordering a heavy-duty cover, see "Accessories."

Annual Maintenance

Your air conditioner needs annual maintenance to help ensure steady, top performance throughout the year. Call your local authorized dealer to schedule an annual checkup. The expense of an annual inspection is your responsibility.

Qualification of Workers

Qualification of the working personnel for maintenance, service and repair operations should according to CAS/UL 60335-2-40:17 Annex HH.. Every working procedure that affects safety means shall only be carried out by competent persons according to Annex HH. Special training additional to usual refrigerating equipment repair procedures is required when equipment with FLAMMABLE REFRIGERANTS is affected.

Troubleshooting

You can solve many common air conditioner problems easily, saving you the cost of a service call. Try the suggestions below to see whether you can solve your problem without outside help.

Air conditioner will not operate

- The power supply cord is unplugged. Plug into grounded 3prong outlet. See “Electrical Requirements.”
- The power supply cord trips (Reset button will pop out). Press and release RESET (listen for click; Reset button will latch and on some devices, a green light will turn on) to resume operation.
- A household fuse has blown or circuit breaker has tripped. Replace the fuse or reset the circuit breaker. See “Electrical Requirements.”
- Depending on model, the Power button has not been pressed or the Fan Speed control is turned to Off. Press POWER button or turn the FAN SPEED control to an active setting.
- The local power has failed. Wait for power to be restored.

Air conditioner blows fuses or trips circuit breakers

- Too many appliances are being used on the same circuit. Unplug or relocate appliances that share the same circuit.
- Time-delay fuse or circuit breaker of the wrong capacity is being used. Replace with a time-delay fuse or circuit breaker of the correct capacity. See “Electrical Requirements.”
- An extension cord is being used. Do not use an extension cord with this or any other appliance.
- You are trying to restart the air conditioner too soon after turning the unit off. Wait at least 3 minutes after turning the unit off before trying to restart the air conditioner.

Air conditioner power supply cord trips (Reset button pops out)

- Disturbances in your electrical current can trip (Reset button will pop out) the power supply cord. Press and release RESET (listen for click; Reset button will latch and on some devices, a green light will turn on) to resume operation.
- An electrical overloading, overheating, pinching or aging can trip (Reset button will pop out) the power supply cord. After correcting the problem, press and release RESET (listen for click; Reset button will latch and on some devices, a green light will turn on) to resume operation.

NOTE: A damaged power supply cord must be replaced with a new power supply cord obtained from the product manufacturer. A damaged power supply cord must not be repaired.

Air conditioner seems to run too much

- The current air conditioner replaced an older model. The use of more efficient components may cause the air conditioner to run longer than an older model, but the total energy consumption will be less. Newer air conditioners do not emit the “blast” of cold air you may be accustomed to from older units, but this is not an indication of lesser cooling capacity or efficiency. Refer to the efficiency rating (EER) and capacity rating (in BTU/hr.) marked on the air conditioner.

- The air conditioner is in a heavily occupied room, or heat-producing appliances are in use in the room. Use exhaust vent fans while cooking or bathing and try not to use heat-producing appliances during the hottest part of the day. A higher capacity air conditioner may be required, depending on the size of the room being cooled.

Air conditioner cycles on and off too much or does not cool

- The Mode is set to Power Saver (on some models). Use Power Saver only when you are away from home or asleep, since the fan does not circulate the room air continuously. Use Low, High or Turbo for your best comfort.
- The air conditioner is not properly sized for your room. Check the cooling capabilities of your room air conditioner. Room air conditioners are not designed to cool multiple rooms.
- The filter is dirty or obstructed by debris. Clean the filter.
- The inside evaporator and outside condenser coils are dirty or obstructed by debris. See “Annual Maintenance.”
- There is excessive heat or moisture (open container cooking, showers, etc.) in the room. Use a fan to exhaust heat or moisture from the room. Try not to use heat-producing appliances during the hottest part of the day.
- The louvers are blocked. Install the air conditioner in a location where the louvers are free from curtains, blinds, furniture, etc.
- The outside temperature is below 65 °F (18°C). Do not try to operate your air conditioner in the cooling mode when the outside temperature is below 65°F (18°C).
- The temperature of the room you are trying to cool is extremely hot. Allow extra time for the air conditioner to cool off a very hot room.
- Windows or doors to the outside are open. Close all windows and doors.
- The Exhaust control is set to OPEN (on some models). Push the Exhaust control CLOSED for maximum cooling.
- Depending on model, the Temp/Time or Temperature control is not at a cool enough setting. Adjust the TEMP/TIME control to a cooler setting by pressing the minus button to reduce the temperature or adjust the TEMPERATURE control to a cooler setting by turning the knob clockwise. Set the FAN SPEED control to highest setting (Turbo or High, depending on model).

Water drips from cabinet into your house

- The air conditioner is not properly leveled. The air conditioner should slope slightly downward toward the outside. Level the air conditioner to provide a downward slope toward the outside to ensure proper drainage. See the Installation Instructions.

NOTE: Do not drill a hole in the bottom of the metal base and condensate pan.

Assistance or Service

Before calling for assistance or service, please check "Troubleshooting." It may save you the cost of a service call. If you still need help, follow the instructions below.

When calling, please know the purchase date and the complete model and serial number of your appliance. This information will help us to better respond to your request.

If you need replacement parts

If you need to order replacement parts, we recommend that you use only factory-authorized replacement parts. These replacement parts will fit right and work right because they are made with the same precision used to build every new appliance.

To locate factory-authorized replacement parts in your area, call us or your nearest designated service center.

In the U.S.A & In Canada

Call the Customer experience center : **086-0756-8668553**.

Our consultants provide assistance with:

- Features and specifications on our full line of appliances.
- Installation information.
- Use and maintenance procedures.
- Accessory and repair parts sales.
- Specialized customer assistance (Spanish speaking, hearing impaired, limited vision, etc.).
- Referrals to local dealers, repair parts distributors, and service companies. Our service technicians are trained to fulfill the product warranty and provide after-warranty service, anywhere in the United States.

To locate the authorized service company in your area, you can also look in your telephone directory Yellow Pages.

For further assistance

If you need further assistance, you can write with any questions or concerns at:

GREE customer experience center
Jinji West Rd. Qianshan
Zhuhai China

Please include a daytime phone number in your correspondence.

Please record your model's information.

Whenever you call to request service on your appliance, you need to know your complete model number and serial number. You can find this information on the model and serial number label. See "Electrical Requirements" for model and serial number location.

Please record the model and serial number information below. Also, record the purchase date of your appliance and the store's name, address, and telephone number.

Model Number _____

Serial Number _____

Purchase Date _____

Store Name _____

Store Address _____

Store Phone _____

Keep this book and the sales slip together for future reference.

Accessories

You can order the following accessories for your air conditioner from your local authorized dealer or by calling **086-0756-8668553** from anywhere in the U.S.A.

Replacement air filters

A good, clean air filter is important for best cooling with least energy consumption. Your air filter should be cleaned regularly. See "Air Conditioner Care" for cleaning instructions. We suggest you replace your air filter once a year.

Heavy-duty cover

If you decide to leave your air conditioner installed during the winter, a heavy-duty cover will help protect your air conditioner and reduce drafts. The outdoor cover protects against cold drafts through the unit's air passages and protects the cabinet from snow, rain, sleet, rust, and dust.

Safety Operation of Flammable Refrigerant

■ Qualification requirement for installation and maintenance man

1. All the work men who are engaging in the refrigeration system should bear the valid certification awarded by the authoritative organization and the qualification for dealing with the refrigeration system recognized by this industry. If it needs other technician to maintain and repair the appliance, they should be supervised by the person who bears the qualification for using the flammable refrigerant.
2. It can only be repaired by the method suggested by the equipment's manufacturer.

■ Installation notes

1. The air conditioner is not allowed to use in a room that has running fire (such as fire source, working coal gas ware, operating heater).
2. The air conditioner must be installed in a room that is larger than the minimum room area.
The minimum room area is shown on the nameplate or following table.
3. Leak test is a must after installation.

table a- Minimum room area (m²)

Minimum room area (m ²)	Charge amount (kg)	≤1.2	1.3	1.4	1.5	1.6	1.7	1.8	1.9	2	2.1	2.2	2.3	2.4	2.5
	floor location	/	14.5	16.8	19.3	22	24.8	27.8	31	34.3	37.8	41.5	45.4	49.4	53.6
window mounted	/	5.2	6.1	7	7.9	8.9	10	11.2	12.4	13.6	15	16.3	17.8	19.3	
wall mounted	/	1.6	1.9	2.1	2.4	2.8	3.1	3.4	3.8	4.2	4.6	5	5.5	6	
ceiling mounted	/	1.1	1.3	1.4	1.6	1.8	2.1	2.3	2.6	2.8	3.1	3.4	3.7	4	

■ Maintenance notes

1. Check whether the maintenance area or the room area meet the requirement of the nameplate.
 - It's only allowed to be operated in the rooms that meet the requirement of the nameplate.
2. Check whether the maintenance area is well-ventilated.
 - The continuous ventilation status should be kept during the operation process.
3. Check whether there is fire source or potential fire source in the maintenance area.
 - The naked flame is prohibited in the maintenance area; and the “no smoking” warning board should be hanged.
4. Check whether the appliance mark is in good condition.
 - Replace the vague or damaged warning mark.

Safety Operation of Flammable Refrigerant

■ Welding

1. If you should cut or weld the refrigerant system pipes in the process of maintaining, please follow the steps as below
 - a. Shut down the unit and cut power supply
 - b. eliminate the refrigerant
 - c. vacuuming
 - d. clean it with N₂ gas
 - e. cutting or welding
 - f. carry back to the service spot for welding
2. The refrigerant should be recycled into the specialized storage tank.
3. Make sure that there isn't any naked flame near the outlet of the vacuum pump and it's well-ventilated.

■ Filling the refrigerant

1. Use the refrigerant filling appliances specialized for R32. Make sure that different kinds of refrigerant won't contaminate with each other.
2. The refrigerant tank should be kept upright at the time of filling refrigerant.
3. Stick the label on the system after filling is finished (or haven't finished)
4. Don't overfilling.
5. After filling is finished, please do the leakage detection before test running; another time of leak detection should be done when it's removed.
6. The filling-work must be performed by authorized personnel only.

■ Safety instructions for transportation and storage

1. Please use the flammable gas detector to check before unload and open the container.
2. No fire source and smoking.
3. According to the local rules and laws.

Safety Notices for Maintenance

■ Storage after moving the unit

1. Do not puncture or light the unit.
2. The unit shall be stored in a room without continuous fire source (e.g. naked fire, litten gas appliance, operating electric heater).
3. The unit shall be stored in a ventilated place; the ventilation device shall operate normally and ventilation port shall be without obstacle;
4. Check the unit periodically to see if there is collision mark and if the appearance is good.
5. Check the electronic components (e.g. cable) periodically to see there is breakage.
6. Do not impact or collapse the unit to avoid leakage of refrigerant; if leakage is founded, please arrange ventilation immediately and ask the professionals for maintenance, in order to avoid a fire hazard.

■ Disposal and recycle

Disposal:

The technician shall be familiar with the device and all its characteristics before disposal. Proceeding safe recycle of refrigerant is recommended. If the recycled refrigerant shall be utilized, please analyze the sample of refrigerant and oil before proceeding. Please ensure the required power supply before testing. Please take the following operation:

1. Be familiar with the device and its operation;
2. Cut off power supply;
3. Make sure the following items before proceeding: If needed, mechanical operation device shall be convenient for the operation of refrigerant tank; all personal protection apparatuses shall be workable and they are used correctly; the whole recycle procedure shall be done under the instruction of qualified person; recycle device and refrigerant tank shall comply with relevant standards.
4. Please arrange vacuum pumping to the refrigeration system if possible; if vacuum status cannot be reached, please arrange vacuum pumping from several positions in order to recycle the refrigerant in different parts of the system;
5. Make sure the capacity of refrigerant tank is sufficient before starting recycle;
6. Start and operate the recycle device according to the operation instruction of manufacturer;
7. The refrigerant tank shall not be too full. (the filled liquid shall not exceed 80% of the capacity of refrigerant tank);
8. Do not exceed the maximum operation pressure although the duration is short;
9. Remove the refrigerant tank and device quickly after finishing operation and make sure all cut-off valves in the device are closed;
10. The recycled refrigerant cannot be filled into another refrigeration system before purification and inspection.

Safety Notices for Maintenance

■ Disposal and recycle

Label :

The unit shall be labeled with data and note after scrapping and discharging refrigerant. Make sure the label on the unit can reflect the R32 refrigerant which it has been filled.

Recycle :

It's recommended to remove the refrigerant in the system before maintenance and disposal.

Put the refrigerant into the specialized refrigerant tank with refrigerant label. The refrigerant tank shall be equipped with pressure-relief valve and cut-off valve, which are in good condition. If possible, the empty tank should be dealt with vacuum pumping before using and keep it in normal temperature.

Recycling device shall be kept in good working status and equipped with operation instructions for reference. The device shall be applicable for the recycle of R32 refrigerant. In addition, qualified weighing apparatus which can be used normally shall be prepared. The hose shall adopt removable connector without leakage for connection and keep it in good status. Check if the recycling device is in normal status before using it and if it is properly stored with all electrical components sealed to prevent fire hazard caused by refrigerant leakage. If you have any question, please consult with the manufacturer.

The recycled refrigerant shall be put in proper container attached with transportation instruction and send it back to the refrigerant manufacturer. Do not mix different refrigerants in the refrigerant recycle device, especially the refrigerant tank.

When disassembling the compressor or clearing the compressor oil, make sure the compressor has been dealt with vacuum pumping to suitable level, so that there is no R32 refrigerant remained in the lubricant. Vacuum pumping shall be done before the compressor is sent back to the supplier. Only electric heating can be adopted for heating the shell of compressor in order to speed up the course. When oil is drained from the system, please ensure the safety.

Information on Servicing

■ Checks to the area

Prior to beginning work on systems containing FLAMMABLE REFRIGERANTS, safety checks are necessary to ensure that the risk of ignition is minimised.

■ General work area

All maintenance staff and others working in the local area shall be instructed on the nature of work being carried out. Work in confined spaces shall be avoided. The area around the workspace shall be sectioned off. Ensure that the conditions within the area have been made safe by control of flammable material.

■ Checking for presence of refrigerant

The area shall be checked with an appropriate refrigerant detector prior to and during work, to ensure the technician is aware of potentially toxic or flammable atmospheres. Ensure that the leak detection equipment being used is suitable for use with all applicable refrigerants, i.e. non-sparking, adequately sealed or intrinsically safe.

■ Presence of fire extinguisher

If any hot work is to be conducted on the refrigeration equipment or any associated parts, appropriate fire extinguishing equipment shall be available to hand. Have a dry powder or CO₂ fire extinguisher adjacent to the charging area.

■ No ignition sources

All possible ignition sources, including cigarette smoking, should be kept sufficiently far away from the site of installation, repairing, removing and disposal, during which refrigerant can possibly be released to the surrounding space. Prior to work taking place, the area around the equipment is to be surveyed to make sure that there are no flammable hazards or ignition risks. "No Smoking" signs shall be displayed.

■ Ventilated area

Ensure that the area is in the open or that it is adequately ventilated before breaking into the system or conducting any hot work. A degree of ventilation shall continue during the period that the work is carried out. The ventilation should safely disperse any released refrigerant and preferably expel it externally into the atmosphere

Information on Servicing

■ Checks to the refrigeration equipment

Where electrical components are being changed, they shall be fit for the purpose and to the correct specification. At all times the manufacturer's maintenance and service guidelines shall be followed. If in doubt, consult the manufacturer's technical department for assistance.

The following checks shall be applied to installations using FLAMMABLE REFRIGERANTS:

- the charge size is in accordance with the room size within which the refrigerant containing parts are installed;
- the ventilation machinery and outlets are operating adequately and are not obstructed;
- if an indirect refrigerating circuit is being used, the secondary circuit shall be checked for the presence of refrigerant;
- marking to the equipment continues to be visible and legible. Markings and signs that are illegible shall be corrected;
- refrigeration pipe or components are installed in a position where they are unlikely to be exposed to any substance which may corrode refrigerant containing components, unless the components are constructed of materials which are inherently resistant to being corroded or are suitably protected against being so corroded.

■ Checks to electrical devices

Repair and maintenance to electrical components shall include initial safety checks and component inspection procedures. If a fault exists that could compromise safety, then no electrical supply shall be connected to the circuit until it is satisfactorily dealt with. If the fault cannot be corrected immediately but it is necessary to continue operation, an adequate temporary solution shall be used. This shall be reported to the owner of the equipment so all parties are advised.

Initial safety checks shall include:

- that capacitors are discharged: this shall be done in a safe manner to avoid possibility of sparking;
- that no live electrical components and wiring are exposed while charging, recovering or purging the system;
- that there is continuity of earth bonding.

■ Repairs to sealed components

During repairs to sealed components, all electrical supplies shall be disconnected from the equipment being worked upon prior to any removal of sealed covers, etc. If it is absolutely necessary to have an electrical supply to equipment during servicing,

Information on Servicing

then a permanently operating form of leak detection shall be located at the most critical point to warn of a potentially hazardous situation.

Particular attention shall be paid to the following to ensure that by working on electrical components, the casing is not altered in such a way that the level of protection is affected. This shall include damage to cables, excessive number of connections, terminals not made to original specification, damage to seals, incorrect fitting of glands, etc.

Ensure that the apparatus is mounted securely.

Ensure that seals or sealing materials have not degraded to the point that they no longer serve the purpose of preventing the ingress of flammable atmospheres. Replacement parts shall be in accordance with the manufacturer's specifications.

■ **Repair to intrinsically safe components**

Do not apply any permanent inductive or capacitance loads to the circuit without ensuring that this will not exceed the permissible voltage and current permitted for the equipment in use. Intrinsically safe components are the only types that can be worked on while live in the presence of a flammable atmosphere. The test apparatus shall be at the correct rating. Replace components only with parts specified by the manufacturer. Other parts may result in the ignition of refrigerant in the atmosphere from a leak.

■ **Cabling**

Check that cabling will not be subject to wear, corrosion, excessive pressure, vibration, sharp edges or any other adverse environmental effects. The check shall also take into account the effects of aging or continual vibration from sources such as compressors or fans.

■ **Detection of flammable refrigerants**

Under no circumstances shall potential sources of ignition be used in the searching for or detection of refrigerant leaks. A halide torch (or any other detector using a naked flame) shall not be used.

■ **Leak detection methods**

The following leak detection methods are deemed acceptable for all refrigerant systems. Electronic leak detectors may be used to detect refrigerant leaks but, in the case of FLAMMABLE REFRIGERANTS, the sensitivity may not be adequate, or may need re-calibration. (Detection equipment shall be calibrated in a refrigerant-free area.) Ensure that the detector is not a potential source of ignition and is suitable for the refrigerant used. Leak detection equipment shall be set at a percentage of the LFL of the refrigerant and shall be calibrated to the refrigerant employed, and the appropriate percentage of gas (25 % maximum) is confirmed.

Information on Servicing

Leak detection fluids are suitable for use with most refrigerants but the use of detergents containing chlorine shall be avoided as the chlorine may react with the refrigerant and corrode the copper pipe-work.

If a leak is suspected, all naked flames shall be removed/extinguished.

If a leakage of refrigerant is found which requires brazing, all of the refrigerant shall be recovered from the system, or isolated (by means of shut off valves) in a part of the system remote from the leak. For appliances containing FLAMMABLE REFRIGERANTS, oxygen free nitrogen (OFN) shall then be purged through the system both before and during the brazing process.

■ Removal and evacuation

When breaking into the refrigerant circuit to make repairs – or for any other purpose – conventional procedures shall be used. However, for flammable refrigerants it is important that the best practice is followed since flammability is a consideration. Opening of the refrigeration systems shall not be done by brazing. The following procedure shall be adhered to:

- remove refrigerant;
- purge the circuit with inert gas;
- evacuate;
- purge again with inert gas;
- open the circuit by cutting or brazing.

The refrigerant charge shall be recovered into the correct recovery cylinders. For appliances containing FLAMMABLE REFRIGERANTS, the system shall be “flushed” with OFN to render the unit safe. This process may need to be repeated several times. Compressed air or oxygen shall not be used for purging refrigerant systems.

For appliances containing FLAMMABLE REFRIGERANTS, flushing shall be achieved by breaking the vacuum in the system with OFN and continuing to fill until the working pressure is achieved, then venting to atmosphere, and finally pulling down to a vacuum. This process shall be repeated until no refrigerant is within the system. When the final OFN charge is used, the system shall be vented down to atmospheric pressure to enable work to take place. This operation is absolutely vital if brazing operations on the pipe-work are to take place.

Ensure that the outlet for the vacuum pump is not close to any ignition sources and that ventilation is available.

■ Charging procedures

In addition to conventional charging procedures, the following requirements shall be followed.

- Ensure that contamination of different refrigerants does not occur when using charging equipment. Hoses or lines shall be as short as possible to minimise the amount of refrigerant contained in them.

Information on Servicing

- Cylinders shall be kept upright.
- Ensure that the refrigeration system is earthed prior to charging the system with refrigerant.
- Label the system when charging is complete (if not already).
- Extreme care shall be taken not to overfill the refrigeration system.

Prior to recharging the system, it shall be pressure-tested with the appropriate purging gas. The system shall be leak-tested on completion of charging but prior to commissioning. A follow up leak test shall be carried out prior to leaving the site.

■ Decommissioning

Before carrying out this procedure, it is essential that the technician is completely familiar with the equipment and all its detail. It is recommended good practice that all refrigerants are recovered safely.

Prior to the task being carried out, an oil and refrigerant sample shall be taken in case analysis is required prior to re-use of reclaimed refrigerant. It is essential that electrical power is available before the task is commenced.

- (a) Become familiar with the equipment and its operation.
- (b) Isolate system electrically.
- (c) Before attempting the procedure, ensure that:
 - mechanical handling equipment is available, if required, for handling refrigerant cylinders;
 - all personal protective equipment is available and being used correctly;
 - the recovery process is supervised at all times by a competent person;
 - recovery equipment and cylinders conform to the appropriate standards.
- (d) Pump down refrigerant system, if possible.
- (e) If a vacuum is not possible, make a manifold so that refrigerant can be removed from various parts of the system.
- (f) Make sure that cylinder is situated on the scales before recovery takes place.
- (g) Start the recovery machine and operate in accordance with manufacturer's instructions.
- (h) Do not overfill cylinders. (No more than 80 % volume liquid charge).
- (i) Do not exceed the maximum working pressure of the cylinder, even temporarily.
- (j) When the cylinders have been filled correctly and the process completed, make sure that the cylinders and the equipment are removed from site promptly and all isolation valves on the equipment are closed off.
- (k) Recovered refrigerant shall not be charged into another refrigeration system unless it has been cleaned and checked.

■ Labelling

Equipment shall be labelled stating that it has been de-commissioned and emptied of refrigerant. The label shall be dated and signed. For appliances containing

Information on Servicing

FLAMMABLE REFRIGERANTS, ensure that there are labels on the equipment stating the equipment contains flammable refrigerant.

■ Recovery

When removing refrigerant from a system, either for servicing or decommissioning, it is recommended good practice that all refrigerants are removed safely.

When transferring refrigerant into cylinders, ensure that only appropriate refrigerant recovery cylinders are employed. Ensure that the correct number of cylinders for holding the total system charge are available.

All cylinders to be used are designated for the recovered refrigerant and labelled for that refrigerant (i.e. special cylinders for the recovery of refrigerant). Cylinders shall be complete with pressure-relief valve and associated shut-off valves in good working order. Empty recovery cylinders are evacuated and, if possible, cooled before recovery occurs.

The recovery equipment shall be in good working order with a set of instructions concerning the equipment that is at hand and shall be suitable for the recovery of all appropriate refrigerants including, when applicable, FLAMMABLE REFRIGERANTS. In addition, a set of calibrated weighing scales shall be available and in good working order. Hoses shall be complete with leak-free disconnect couplings and in good condition. Before using the recovery machine, check that it is in satisfactory working order, has been properly maintained and that any associated electrical components are sealed to prevent ignition in the event of a refrigerant release. Consult manufacturer if in doubt.

The recovered refrigerant shall be returned to the refrigerant supplier in the correct recovery cylinder, and the relevant waste transfer note arranged. Do not mix refrigerants in recovery units and especially not in cylinders.

If compressors or compressor oils are to be removed, ensure that they have been evacuated to an acceptable level to make certain that flammable refrigerant does not remain within the lubricant. The evacuation process shall be carried out prior to returning the compressor to the suppliers. Only electric heating to the compressor body shall be employed to accelerate this process. When oil is drained from a system, it shall be carried out safely.

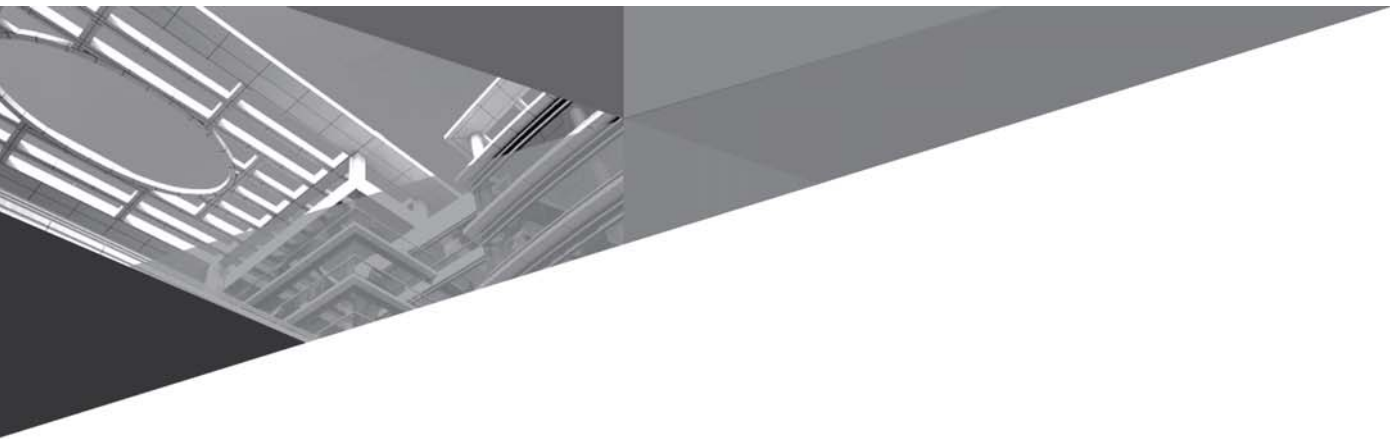

GREE ELECTRIC APPLIANCES, INC. OF ZHUHAI

Add: West Jinji Rd, Qianshan, Zhuhai, Guangdong, China, 519070

Tel: (+86-756) 8522218

Fax: (+86-756) 8669426

E-mail: global@cn.gree.com

Web: www.gree.com



600005062354