

WINDOW/WALL-TYPE ROOM AIR CONDITIONER

Keystone™

USER'S MANUAL

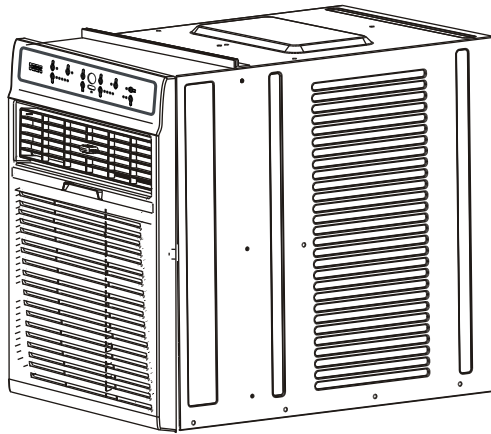

Model: KSTSW08A
KSTSW10A

TABLE OF CONTENTS

Important Safety Instructions	1-3	Normal Sounds	13
Installation Instructions	4-12	Air Conditioner Features	13-15
		Care and Cleaning	15-16
		Troubleshooting Tip	16-17

Before using your air conditioner, please read
this manual carefully and keep it for future reference.



Tarjeta de Registracion de Producto

Es sencillo! Cumple y envia su Tarjeta de Registracion de Producto hoy!

Nombre _____
Dirección _____
Ciudad _____ Estado _____ Código postal _____
Teléfono (Opcional) _____ / _____ - _____
Direccion de E-mail (Opcional) _____
Donde Comprado _____

_____ _____ _____
Numero de Modelo Numero de Serie Mes Dia Año
Fecha de la compra

REV 11/04

Porfavor devuelve su Tarjeta de Registracion de Producto hoy!



Product Registration Card

It's simple! Complete and mail your Product Registration Card today!

Name _____
Address _____
City _____ State _____ Zip _____
Phone (Optional) _____ / _____ - _____
E-mail Address (Optional) _____
Where Purchased _____

_____ _____ _____
Model Number Serial Number Month Day Year
Date of Purchase

REV 11/04

Please return your Product Registration Card today!



PLACE
STAMP
HERE

Postage
Required,
Post Office will
not deliver
without proper
postage.

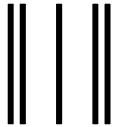



Product Warranty Card

Tarjeta de Garantia de Producto

Air conditioner warranty

Your product is protected by this warranty:
Your appliance is warranted by Keystone. Any obligations for services and parts under this warranty must be performed Keystone.

To contact a Customer Service Representative, Call TOLL FREE

800-849-1112

keystonecs@keystone-products.com

Garantia

Su producto está protegido por esta garantía:
Su producto está garantizado por Keystone. Cualquier obligación de proporcionar servicio o repuestos establecida en esta garantía deberá ser cumplida por los Servicios al consumidor de Keystone.

Para comunicarse con un Representante de Servicio al Cliente, tenga la bondad de llamar por teléfono sin cargo alguno a, al número:

800-849-1112





keystonecs@keystone-products.com

IMPORTANT SAFETY INSTRUCTIONS















READ THIS MANUAL

Inside you will find many helpful hints on how to use and maintain your air conditioner properly. Just a little preventive care on your part can save you a great deal of time and money over the life of your air conditioner. You'll find many answers to common problems in the chart of troubleshooting tips. If you review our chart of Troubleshooting Tips first, you may not need to call for service at all.

To prevent injury to the user or other people and property damage, the following instructions must be followed. Incorrect operation due to ignoring of instructions may cause harm or damage. The seriousness is classified by the following indications.

 WARNING	This symbol indicates the possibility of death or serious injury.		
 CAUTION	This symbol indicates the possibility of injury or damage to property.		
	Never do this.		Always do this.

WARNING

<p> Plug in power plug properly.</p> <ul style="list-style-type: none"> Otherwise, it may cause electric shock or fire due to excess heat generation. 	<p> Do not operate or stop the unit by inserting or pulling out the power plug.</p> <ul style="list-style-type: none"> It may cause electric shock or fire due to heat generation. 	<p> Do not damage or use an unspecified power cord.</p> <ul style="list-style-type: none"> It may cause electric shock or fire. If the power cord is damaged, it must be replaced by the manufacturer or an authorised service centre or a similarly qualified person in order to avoid a hazard.
<p> Always install circuit breaker and a dedicated power circuit.</p> <ul style="list-style-type: none"> Incorrect installation may cause fire and electric shock. 	<p> Do not operate with wet hands or in damp environment.</p> <ul style="list-style-type: none"> It may cause electric shock. 	<p> Do not direct airflow at room occupants only.</p> <ul style="list-style-type: none"> This could damage your health.
<p> Always ensure effective grounding.</p> <ul style="list-style-type: none"> Incorrect grounding may cause electric shock. 	<p> Do not allow water to run into electric parts.</p> <ul style="list-style-type: none"> It may cause failure of machine or electric shock. 	<p> Do not modify power cord length or share the outlet with other appliances.</p> <ul style="list-style-type: none"> It may cause electric shock or fire due to heat generation.
<p> Unplug the unit if strange sounds, smell, or smoke comes from it.</p> <ul style="list-style-type: none"> It may cause fire and electric shock. 	<p> Do not use the socket if it is loose or damaged.</p> <ul style="list-style-type: none"> It may cause fire and electric shock. 	<p> Do not open the unit during operation.</p> <ul style="list-style-type: none"> It may cause electric shock.
<p> Keep firearms away.</p> <ul style="list-style-type: none"> It may cause fire. 	<p> Do not use the power cord close to heating appliances.</p> <ul style="list-style-type: none"> It may cause fire and electric shock. 	<p> Do not use the power cord near flammable gas or combustibles, such as gasoline, benzene, thinner, etc.</p> <ul style="list-style-type: none"> It may cause an explosion or fire.
<p> Ventilate room before operating air conditioner if there is a gas leakage from another appliance.</p> <ul style="list-style-type: none"> It may cause explosion, fire and, burns. 	<p> Do not disassemble or modify unit.</p> <ul style="list-style-type: none"> It may cause failure and electric shock. 	

IMPORTANT SAFETY INSTRUCTIONS

CAUTION

- | | | |
|---|--|--|
| <ul style="list-style-type: none"> ⊘ When the air filter is to be removed, do not touch the metal parts of the unit. ● It may cause an injury. | <ul style="list-style-type: none"> ⊘ Do not put a pet or house plant where it will be exposed to direct air flow. ● This could injure the pet or plant. | <ul style="list-style-type: none"> ⊘ Ventilate the room well when used together with a stove, etc. ● An oxygen shortage may occur. |
| <ul style="list-style-type: none"> ⊘ Do not use strong detergent such as wax or thinner but use a soft cloth. ● Appearance may be deteriorated due to change of product color or scratching of its surface. | <ul style="list-style-type: none"> ⊘ Do not clean the air conditioner with water. ● Water may enter the unit and degrade the insulation. It may cause an electric shock. | <ul style="list-style-type: none"> ⊘ Do not use for special purposes. ● Do not use this air conditioner to preserve precision devices, food, pets, plants, and art objects. It may cause deterioration of quality, etc. |
| <ul style="list-style-type: none"> ⊘ Stop operation and close the window in storm or hurricane. ● Operation with windows opened may cause wetting of indoor and soaking of household furniture. | <ul style="list-style-type: none"> ⊘ When the unit is to be cleaned, switch off, and turn off the circuit breaker. ● Do not clean unit when power is on as it may cause fire and electric shock, it may cause an injury. | <ul style="list-style-type: none"> ⊘ Ensure that the installation bracket of the outdoor appliance is not damaged due to prolonged exposure. ● If bracket is damaged, there is concern of damage due to falling of unit. |
| <ul style="list-style-type: none"> ⊘ Always insert the filters securely. Clean filter once every two weeks. ● Operation without filters may cause failure. | <ul style="list-style-type: none"> ⊘ Hold the plug by the head of the power plug when taking it out. ● It may cause electric shock and damage. | <ul style="list-style-type: none"> ⊘ Turn off the main power switch when not using the unit for a long time. ● It may cause failure of product or fire. |
| <ul style="list-style-type: none"> ⊘ Do not place obstacles around air-inlets or inside of air-outlet. ● It may cause failure of appliance or accident. | <ul style="list-style-type: none"> ⊘ Do not place heavy object on the power cord and ensure that the cord is not compressed. ● There is danger of fire or electric shock. | <ul style="list-style-type: none"> ⊘ Do not drink water drained from air conditioner. ● It contains contaminants and could make you sick. |
| <ul style="list-style-type: none"> ⊘ Use caution when unpacking and installing. Sharp edges could cause injury. | <ul style="list-style-type: none"> ⊘ If water enters the unit, turn the unit off at the power outlet and switch off the circuit breaker. Isolate supply by taking the power-plug out and contact a qualified service technician. | |

CAUTION

- This appliance is not intended for use by persons (including children) with reduced physical, sensory or mental capabilities or lack of experience and knowledge, unless they have been given supervision or instruction concerning use of the appliance by a person responsible for their safety.
- Children should be supervised to ensure that they do not play with the appliance.
- If the supply cord is damaged, it must be replaced by the manufacturer, its service agent or similarly qualified persons in order to avoid a hazard.
- The appliance shall be installed in accordance with national wiring regulations.
- Do not operate your air conditioner in a wet room such as a bathroom or laundry room.
- The appliance with electric heater shall have at least 1 meter space to the combustible materials.
- Contact the authorised service technician for repair or maintenance of this unit.
- Contact the authorised installer for installation of this unit.

IMPORTANT SAFETY INSTRUCTIONS

NOTE:

The power supply cord with this air conditioner contains a current detection device designed to reduce the risk of fire. Please refer to the section Operation of Current Device for details. In the event that the power supply cord is damaged, it cannot be repaired-it must be replaced with a cord from the Product Manufacturer.

WARNING

Avoid fire hazard or electric shock. Do not use an extension cord or an adaptor plug. Do not remove any prong from the power cord.

Grounding type wall receptacle

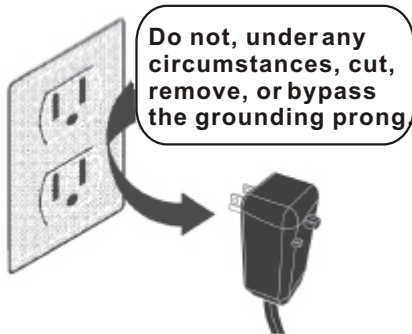

Power supply cord with 3-prong grounding plug and current detection device

WARNING

For Your Safety

Do not store or use gasoline or other flammable vapors and liquids in the vicinity of this or any other appliance.

WARNING

Prevent Accidents

To reduce the risk of fire, electrical shock, or injury to persons when using your air conditioner, follow basic precautions, including the following:

- Be sure the electrical service is adequate for the model you have chosen. This information can be found on the serial plate, which is located on the side of the cabinet and behind the grille.
- If the air conditioner is to be installed in a window, you will probably want to clean both sides of the glass first. If the window is a triple-track type with a screen panel included, remove the screen completely before installation.
- Be sure the air conditioner has been securely and correctly installed according to the installation instructions in this manual. Save this manual for possible future use in removing or installing this unit.
- When handling the air conditioner, be careful to avoid cuts from sharp metal fins on front and rear coils.

WARNING

Electrical Information

The complete electrical rating of your new room air conditioner is stated on the serial plate. Refer to the rating when checking the electrical requirements.

- Be sure the air conditioner is properly grounded. To minimize shock and fire hazards, proper grounding is important. The power cord is equipped with a three-prong grounding plug for protection against shock hazards.
- Your air conditioner must be used in a properly grounded wall receptacle. If the wall receptacle you intend to use is not adequately grounded or protected by a time delay fuse or circuit breaker, have a qualified electrician install the proper receptacle. Ensure the receptacle is accessible after the unit installation.
- Do not run air conditioner without side protective cover in place. This could result in mechanical damage within the air conditioner.
- **Do not use an extension cord or an adaptor plug.**

Operation of Current Device

(Applicable to the unit adopts current detection device only)

The power supply cord contains a current device that senses damage to the power cord. To test your power supply cord do the following:

1. Plug in the Air Conditioner.
2. The power supply cord will have TWO buttons on the plug head. Press the TEST button, you will notice a click as the RESET button pops out.
3. Press the RESET button, again you will notice a click as the button engages.
4. The power supply cord is now supplying electricity to the unit. (On some products this is also indicated by a light on the plug head.)

NOTE:

- Do not use this device to turn the unit on or off.
- Always make sure the RESET button is pushed in for correct operation.
- The power supply must be replaced if it fails reset when either the TEST button is pushed, or it cannot be reset. A new one can be obtained from the product manufacturer.
- If power supply cord is damaged, it cannot be repaired. It MUST be replaced by one obtained from the product manufacturer.

NOTE: This air conditioner is designed to be operated under condition as follows:

Cooling operation	Outdoor temp:	64-109°F/18-43°C (64-125°F/18-52°C for special tropical models)
	Indoor temp:	62-90°F/17-32°C
Heating operation	Outdoor temp:	23-76°F/-5-24°C
	Indoor temp:	32-80°F/0-27°C

Note: Performance may be reduced outside of these operating temperatures.

INSTALLATION INSTRUCTIONS



BEFORE YOU BEGIN

Read these instructions completely and carefully.

IMPORTANT- Save these instructions for local inspector's use.

IMPORTANT- Observe all governing codes and ordinances.

Note to Installer- Be sure to leave these instructions with the Consumer.

Note to Consumer- Keep these instructions for future reference.

Skill level- Installation of this appliance requires basic mechanical skills.

Completion time- Approximately 1 hour.

We recommend that two people install this product.

Proper installation is the responsibility of the installer.

Product failure due to improper installation is not covered under the Warranty.

You **MUST** use all supplied parts and use proper installation procedures as described in these instructions when installing this air conditioner.



NOTE:

These instructions describe installation in a typical wood framed window with a wood SLIDE-BY sash, or installation in a metal CASEMENT window. Modification may be necessary when installing in windows made differently than those shown in these instructions.



NOTE:

Save Carton and these Installation Instructions for future reference. The carton is the best way to store unit during winter, or when not in use. When handling unit, be careful to avoid cuts from sharp metal edges and aluminum fins on front and rear coils.

Meeting Electrical Requirements



WARNING

Electrical Shock and Personal Injury Hazard

- Electrical ground is required on this appliance.
- DO NOT ground to a gas line.

- If cold water pipe is interrupted by plastic, non-metallic gaskets, or other insulating materials, DO NOT use for grounding.
- Check with a qualified electrician if you are in doubt as to whether the appliance is properly grounded.
- DO NOT modify power supply cord plug. If it does not fit outlet, have a proper outlet installed by a qualified electrician.
- DO NOT have a fuse in the neutral or grounding circuit. A fuse in the neutral, or grounding circuit could result in an electrical shock.
- DO NOT use an extension cord with this appliance.

Failure to follow these instructions could result in electrical shock, serious injury, or death.

Observe all local governing codes and ordinances.

Do not, under any circumstances, remove the power supply cord grounding prong.

NOTE: If codes permit, and a separate grounding wire is used; it is recommended that a qualified electrician determine that the grounding path is adequate and not interrupted by plastic, non-metallic gaskets, or other insulating materials.

Receptacle wiring

Receptacle wiring should be a minimum of 14 gauge. Use copper wire only. It is your responsibility to provide proper and adequate receptacle wiring, installed by a qualified electrician.

Electrical requirements

A time delay fuse or time delay circuit breaker is also required. A separate circuit, serving only this appliance, MUST be provided.

Preparing for Installation

Installation Tips

For wood-frame casement windows: It may be necessary to construct a frame, using at least 1-inch thick wood, with a 15-1/2-inch wide opening.

For brick or cement building construction: It may be necessary to put a wood stool strip under AC, for mounting purposes.

Tools Required:

Flat-head screwdriver; Phillips-head screwdriver
Carpenter's level; Tape measure
Fine tooth saw; Electric or hand drill

INSTALLATION INSTRUCTIONS

1. Make sure you have all the necessary parts.

Installation kit contents:

1. Platform(1)
2. Support brace(1)
3. Adjustment bolt(1)
4. Hex flange nut - 1 / 4"(1)
5. Track seal(1)
6. Side channel seal(1)
7. Foam seal strip/Sash seal
8. Safety bracket(1)
- 9-11. Screw-2-1/2" (2), or
Screw-1-3/4" (2), or
Screw-1"(2)
12. Screw-3/4" (6)
13. Screw-3/4" self-threading(7)
14. Window locking bracket(1)
15. Plastic window panel(1)
16. Side channel(2)
17. Screw-3/8" (6)
18. Panel frame/seal assembly(1)
19. R1 hardware(1)

NOET: R1 hardware is only for Energy star models.

NOTE: Use scale below to measure length of your screws. The scale will come in handy when separating screws for installation.

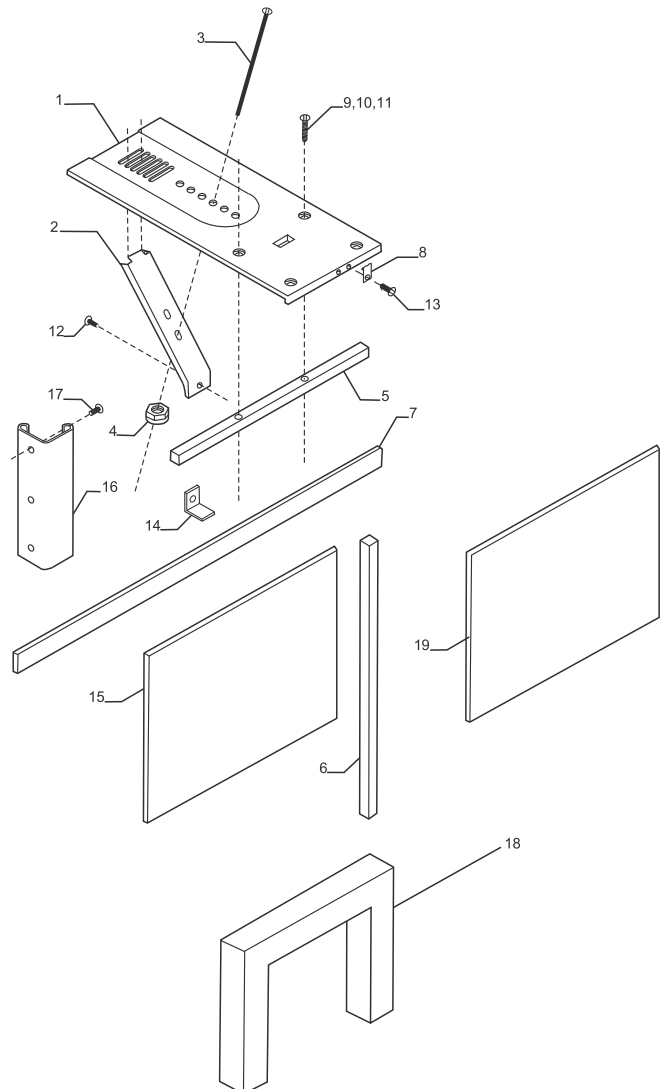
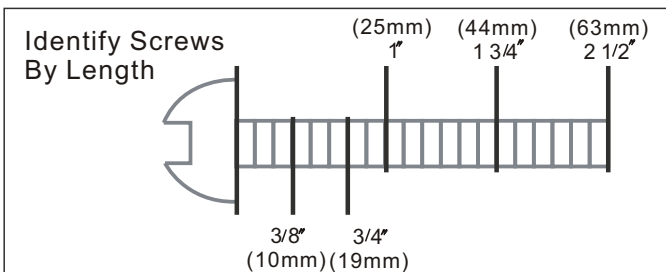

2. Choose a proper sized window, as shown right.

- 15-1/2 inches minimum width
- 16-1/4 inches maximum width (for casement windows)
- 21-1/4 inches minimum height (with window panel retainer)
- 20-5/16 inches minimum height (window panel retainer removed)
- 39-7/16 inches maximum height

NOTE: Height measurement must be of a clear opening above mounting platform. In some cases, due to a variety of stop and track arrangements, the above dimensions may vary slightly. If necessary, installation can be made by alternating window jambs. (See Alternate Window Jamb Applications.) (continued)

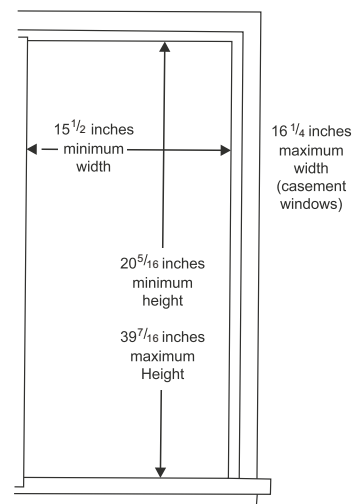

INSTALLATION INSTRUCTIONS

3. Choose the proper window location.

Choose a window that allows the cooled air to flow freely and directly into room(s) you wish to cool. Remember, it is difficult to move air around corners. Also, choose a window that is within 6 feet of an electrical outlet. (See Meeting Electrical Requirements/Receptacle wiring needs.) **Do not use an extension cord.**

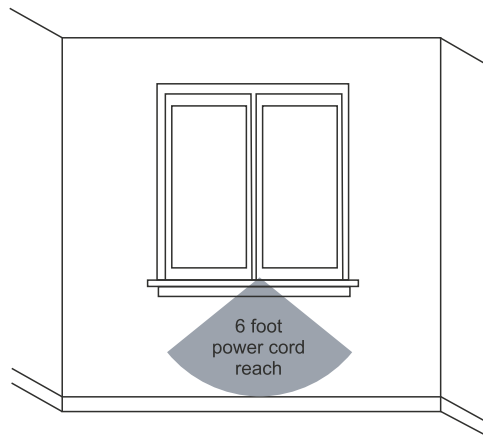

Installing Unit in a Sliding Window

1. Attach support brace to platform as shown. Use adjustment bolt and hex flange nut to complete assembly. Choose slot and adjustment bolt hole locations that will create a 45 degree angle between platform and support brace. Try assembly in the window to determine if platform will rest properly, and allow proper slope (3/16-inch lower on outside).

NOTE: If you are planning to use a siding-protection board (see Step 5) on the outside of your house, hold board in place when testing assembly in window.

2. Measure, and lightly mark a line 8-11/16 inches from window jamb.

NOTE: If any sash stop protrudes more than 1 inch from the side window jambs, the 8-11/16-inch measurement must be increased accordingly. Screen and storm window frames may also require adjustments to the measurement.

3. Center platform assembly on the line with inside platform tab pressed against inside edge of window track. Using the holes in the platform as a guide, mark and drill two 9/64-inch diameter holes. Drill holes in either track or stool.

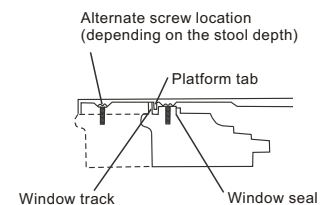
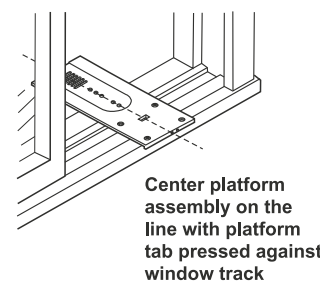
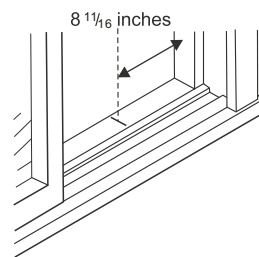
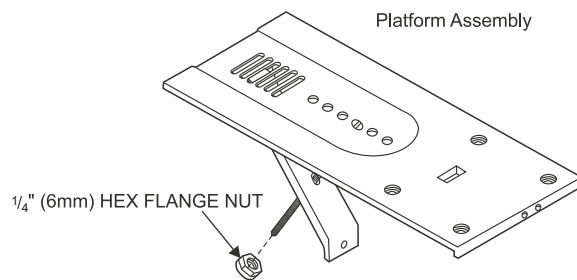

CAUTION

Property Damage Hazard-Failure to adhere to the following precaution could result in damage to window or air conditioner.

Be sure wood stool or window track is securely attached to the building construction. Use longer screws in sub-framing if necessary.

(continued)

INSTALLATION INSTRUCTIONS

4. Peel off protective backing from track seal. Apply seal to room side of window track. Center of seal strip should coincide with the line marked in Step 2. The two screw holes drilled in Step 3 should be directly above seal strip in the inner track.

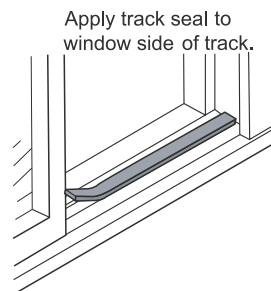

5. Securely attach a siding-protection board to side of house.

NOTE: Siding-protection board should be long enough to span 2 wall studs.

NOTE: Adjust the platform assembly so that the air conditioner will be $1\frac{1}{8}$ " to $1\frac{1}{2}$ " lower than the front (tilted about 3° to 4° downward to the outside). After proper installation, condensate should not drain from the overflow drain hole during normal use, correct the slope otherwise.

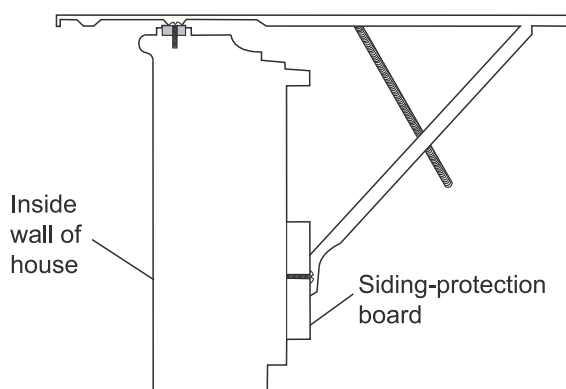

6. Place platform assembly, with platform tab against inside of window track, and attach it to window jamb. Use appropriate length screws (Items 9-11 in Preparing For Installation).

7. Adjust platform assembly so that it is tilted $3\sim 4^\circ$ to the outside, as shown right. This ensures proper water drainage from the air conditioner.

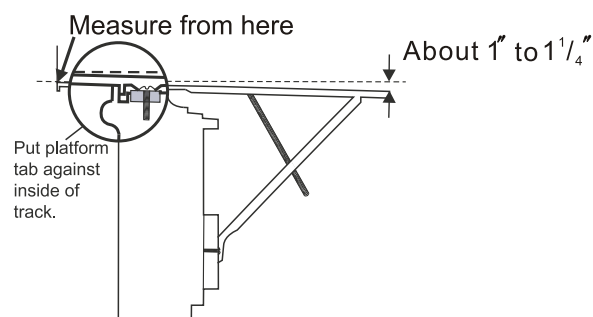

8. Level platform assembly from side-to-side.

Also, make sure window track is level. Use leveling shims as necessary to ensure unit is level from side-to-side.

9. Measure height of window opening from top of platform assembly as shown right. Subtract $20\frac{5}{8}$ inches. Mark this measurement on plastic window panel, along the longer side. (continued)

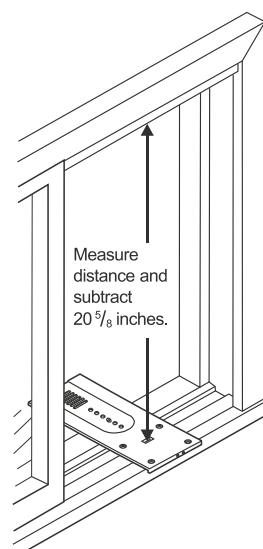

INSTALLATION INSTRUCTIONS

10. Clamp plastic window panel between a board and a work table, and cut along cutting line with a fine tooth saw. Remove any burrs with a file.

11. Fasten side channels to the sides of the AC using 3 screws (Item 17) per channel. Start with first screw at top of channel. Make sure hook ends of channels face toward back of unit.

12. Slide plastic window panel into panel frame, with the smooth side to the room. Slide panel frame assembly into side channels of the AC cabinet. Make sure plastic window panel is firmly enclosed on all sides by the retainer grooves.

13. Cut side channel seal into 2 equal lengths. Remove protective backing and apply it to the rear side of cabinet side channels, starting just below panel frame assembly. Pinch off excess length so seal is even with the bottom of the cabinet side channel.

14. To remove front

1. Remove the two front retaining screws from the front frame.
2. Gently pull the front out and lift up to release it from the case.
3. Then release the coupler plugs.

NOTE: DO NOT push or pull air direction louvers.

15. Place AC in window opening. As shown right, it should sit on platform assembly so that window panel frame, and cabinet side channels are against top and side window jambs. (continued)

Fastening Side Channels

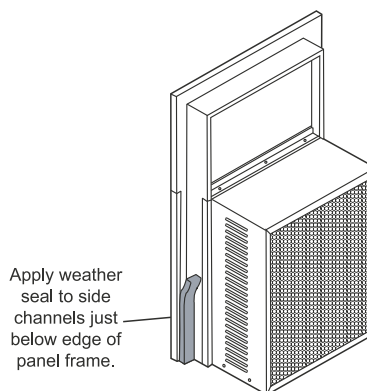
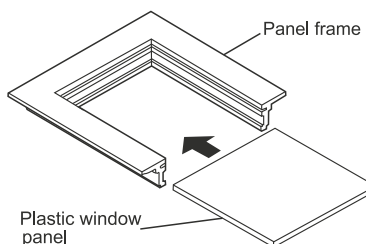
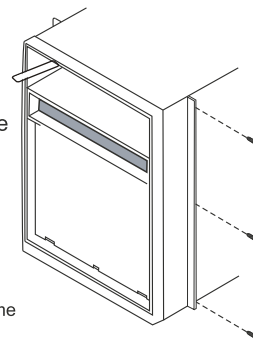

Front Retaining Screw

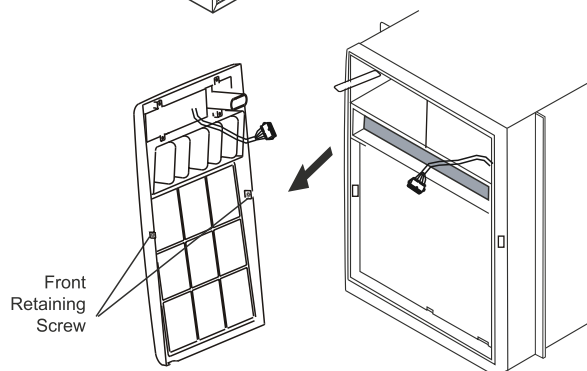

Slide inner window sash firmly against Cabinet.

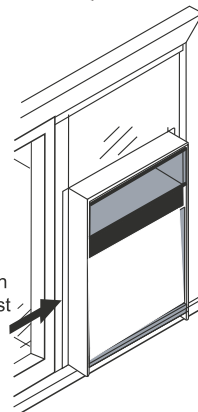

INSTALLATION INSTRUCTIONS

16. Slide inner window sash firmly against side of the cabinet. Make sure not to peel the seal strips from the window track and cabinet side channels. If the panel frame does not fit snugly to the inner window sash, secure the panel frame to the sash with 3/4-inch screws, or 3/4-inch self-threading screws. Use the partially plugged holes in the panel frame. Drill 1/8-inch pilot holes for the screws.

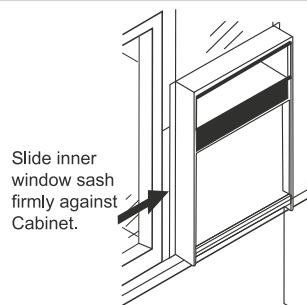

17. Hook the safety bracket over the base of the unit and fasten it to the front of the platform assembly. Use a 3/4-inch self-threading screw.

NOTE: The bracket prevents movement of the air conditioner (either in or out) after completing the installation.

18. Stuff the foam seal strip/sash seal between the vertical sash and the window glass, as shown right.

19. Use the window locking bracket to lock the inner window sash to the base of the outer window sash. Use one 3/4-inch screw, or 3/4-inch self-threading screw. (Drill 1/8-inch pilot hole).

Install safety bracket

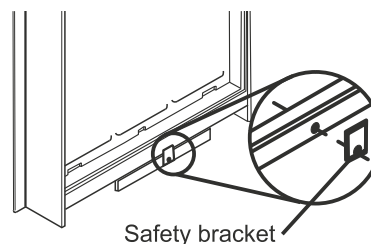

20. To replace the front

First reconnect the coupler plugs, make the Exhaust control positioned through the front in the proper location. Then replace the retaining screws that holds the panel in place. **Do not** push or pull the front panel louvers.

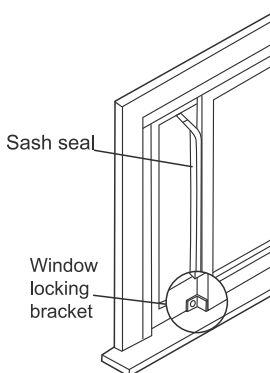

21. Inst all the R1 hardware (Only be applicable to Energy star models)

In order to minimize air leaks and ensure optimal insulation, it is necessary to install the included R1 hardware to the plastic window panel. Follow the instructions below.

Step 1. After the unit is installed to the window, measure the inner height of the panel frame to the top of the unit.

Step 2. Remark a line on the provide R1 hardware according to the measured height in step 1, then cut the R1 insulation panel along the line.

Step 3. Remove the tape of the R1 hardware, then attach to the plastic window panel.

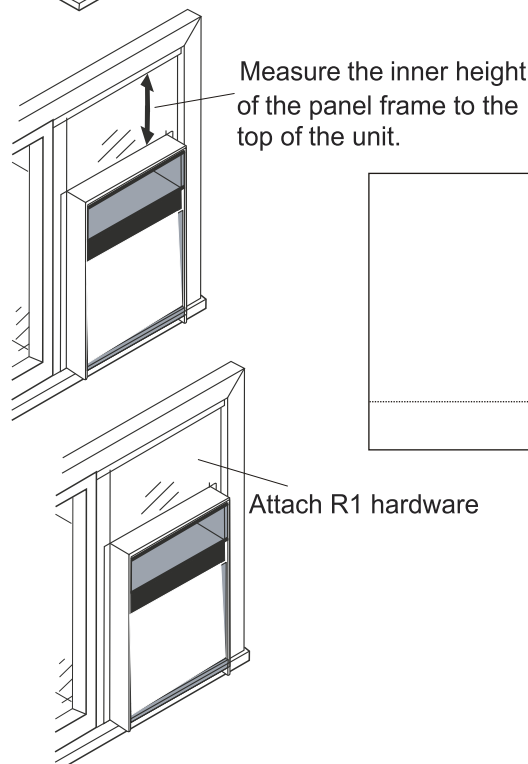

INSTALLATION INSTRUCTIONS

Alternate Window Jamb Applications

To install in windows having no flanges or wood stops on the top and side jambs, the channels and panel frame must fit against a mating flange (or 1/16-inch max. thick angle) attached to the window jambs. Figure A shows this angle installed. Figures B & C show alternate treatments. On the sash side of the opening, the leading corner of the inner sash becomes the flange. You can purchase the angle strip locally.

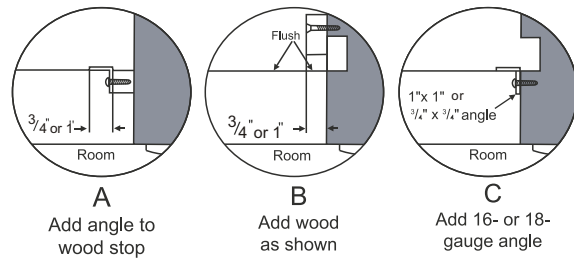

Installing the Unit in a Casement Window

NOTE: Open the window the maximum amount to allow for clearance of the cabinet. The crank handle should be removed to allow the platform to be fastened to the jamb. If the window cannot open far enough (more than 15-1/2 inches) for the cabinet to clear the window, remove the window entirely by drilling out the rivets. Bolts can serve as the pivots in the future.

To avoid crank handle and window clearance problems, the unit can be installed in a stationary sash section. However, the horizontal mullion and the 2 glass panels must be removed before installation.

1. Attach support brace to platform as shown. Use the adjustment bolt and hex flange nut to complete the assembly. Choose the slot and adjustment bolt hole locations that will create a 45 degree angle between the platform and the support brace. Try the assembly in the window to determine if the platform will rest properly, and allow the proper slope (3/16-inch lower on outside).

NOTE: If you are planning to use a siding-protection board (see Step 6) on the outside of your house, hold the board in place when testing the assembly in the window.

2. Drill a 9/64-inch diameter pilot hole in the window jamb an equal distance from each side of the jamb, and 3/16-inch up from the window sill. If the hole coincides with the window lever slot in the jamb bottom, an additional hole will have to be drilled through the platform edge and the window jamb to miss this slot.

3. Peel off the protective backing from the track seal, and stick the seal to the window sill on the outside of the bottom jamb.

4. Screw the platform assembly to the window jamb through the pilot hole you drilled in Step 2. Use a 3/4-inch self-threading screw. (continued)

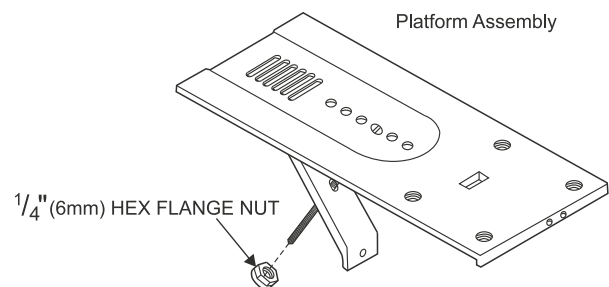

Equal distance from both sides

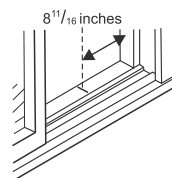

Apply track seal to the outside edge of the bottom window jamb.

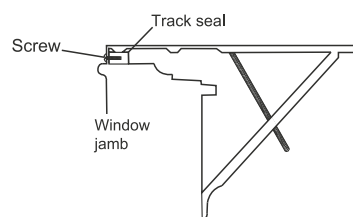
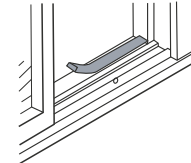

INSTALLATION INSTRUCTIONS

5. Adjust the platform assembly so that the rear of the air conditioner will be $\frac{3}{16}$ -inch lower than the front. This ensures proper water drainage from the air conditioner.

NOTE: Adjust the platform assembly so that the air conditioner will be $\frac{1}{8}$ " to $1\frac{1}{2}$ " lower than the front (tilted about 3° to 4° downward to the outside). After proper installation, condensate should not drain from the overflow drain hole during normal use, correct the slope otherwise.

6. Securely attach a siding-protection board to the side of the house where the platform assembly hit the house. The siding-protection board should be long enough to span 2 wall studs.

7. Measure the height of the window opening from the top of the platform assembly. Subtract $20\frac{5}{8}$ inches. Mark this measurement on the plastic window panel, along the longer side.

8. Clamp the plastic window panel between a board and a work table, and cut along the cutting line with a fine tooth saw. Remove any burrs with a file.

9. Fasten the side channels to the sides of the unit using three screws (Item 17) per channel. Make sure hook ends of channels face toward the back of unit.

10. Slide the plastic window panel into the panel frame with the smooth side to the outside. Slide the panel frame assembly into the side channels of the air conditioner cabinet. Make sure the plastic window panel is firmly enclosed on all sides by the retainer grooves. (continued)

11. Cut side channel seal into 2 equal lengths. Remove the protective backing and apply it to the rear side of the cabinet side channels, starting just below the panel frame assembly. Pinch off excess length so the seal is even with the bottom of the cabinet side channel.

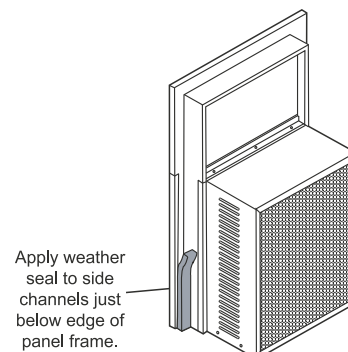
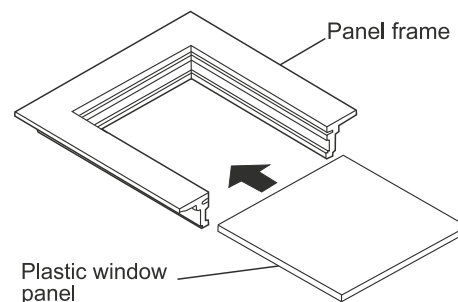
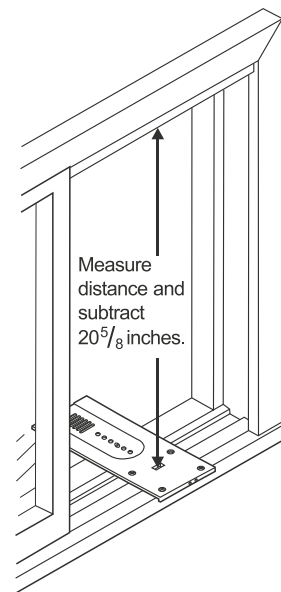
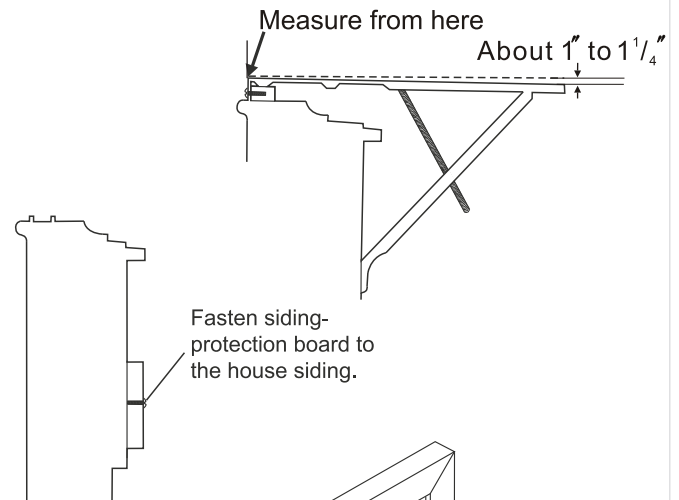

INSTALLATION INSTRUCTIONS

12. To remove front

1. Remove the two front retaining screws from the front frame.
2. Gently pull the front out and lift up to release it from the case.
3. Then release the coupler plugs.

NOTE: DO NOT push or pull air direction louvers.

13. Place the air conditioner in the window opening as shown to the right. It should sit on the platform assembly so that the window panel frame, and the cabinet side channels are against the top and side window jambs. Side channels should overlap side window jambs equally.

14. Drill two 9/64-inch diameter pilot holes in the top window jamb in line with the partially plugged holes in the panel frame. Secure the panel frame to the window jamb with two 3/4-inch self-threading screws. If additional holding is necessary, two screws may be used on the sides of the panel frame as well.

15. Drill two screw-clearance holes in the cabinet side channels (near bottom) and two 9/64-inch diameter pilot holes in the side window jambs. Secure the cabinet side channels to the window jambs with two 3/4-inch self-threading screws. When doing this, be careful not to twist the side channel seals with the screws.

NOTE: Inserting screws will prevent the air conditioner from being pushed into the room.

16. To replace the front

First reconnect the coupler plugs, make the Exhaust control positioned through the front in the proper location. Then replace the retaining screws that holds the panel in place. **Do not** push or pull the front panel louvers.

17. Inst all the R1 hardware (Only be applicable to Energy star models)

In order to minimize air leaks and ensure optimal insulation, it is necessary to install the included R1 hardware to the plastic window panel. Follow the instructions below.

Step 1. After the unit is installed to the window, measure the inner height of the panel frame to the top of the unit.

Step 2. Remark a line on the provide R1 hardware according to the measured height in step 1, then cut the R1 insulation panel along the line.

Step 3. Remove the tape of the R1 hardware, then attach to the plastic window panel.

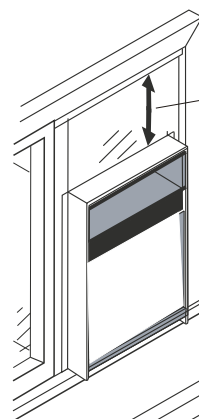
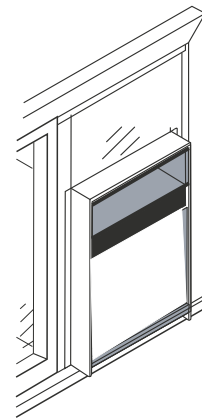
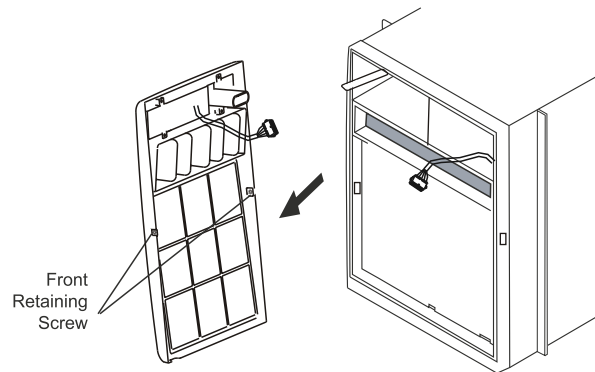

Measure the inner height of the panel frame to the top of the unit.

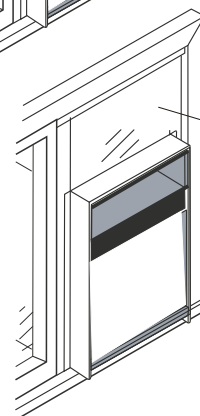

Attach R1 hardware

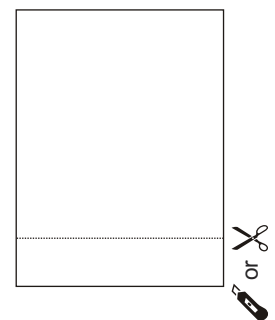

or

NORMAL SOUNDS

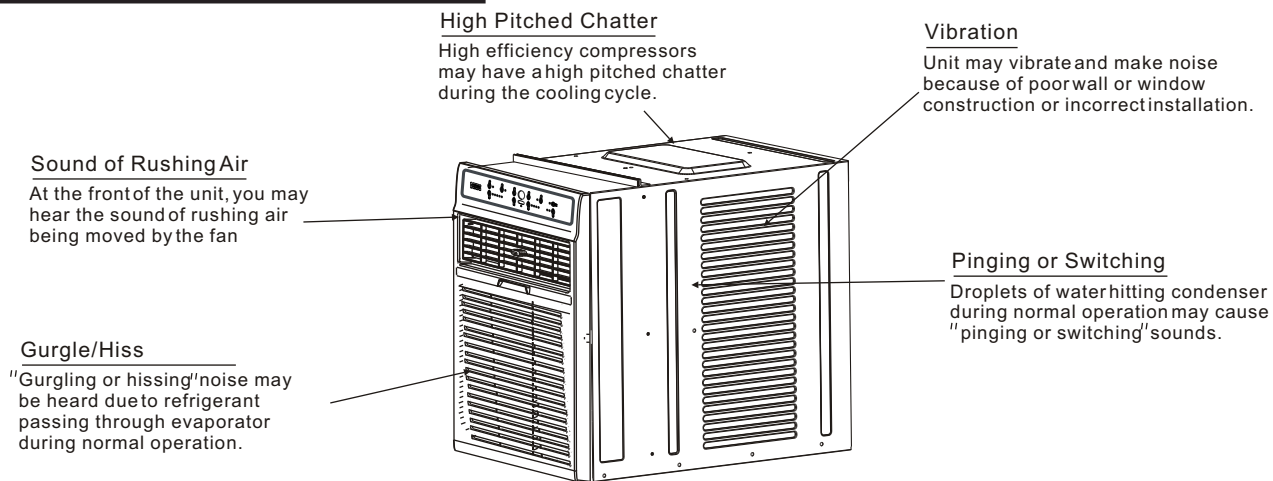

NOTE:

All the illustrations in this manual are for explanation purpose only. Your air conditioner may be slightly different. The actual shape shall prevail.

AIR CONDITIONER FEATURES

ELECTRONIC CONTROL OPERATING INSTRUCTIONS

Before you begin, thoroughly familiarize yourself with the control panel as shown below and all its functions, then follow the symbol for the functions you desire. **The unit can be controlled by the unit control alone or with the remote.**

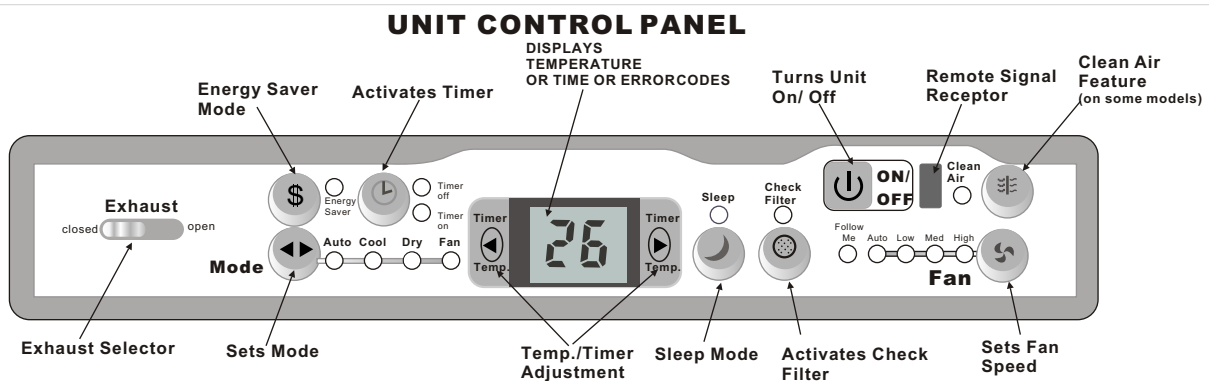

TO TURN UNIT ON OR OFF:

Press ON/OFF button to turn unit on or off.

NOTE: The unit will initiate automatically the Energy Saver function under Cool, Dry, Auto (only Auto-Cooling and Auto-Fan) modes.

CLEAN AIR FEATURE: (on some models)

Press Clean Air button, the ion generator is energized and will help to remove pollen and impurities from the air, and trap them in the filter.

TO CHANGE TEMPERATURE SETTING:

Press UP/DOWN button to change temperature setting.

NOTE: Press or hold either UP () or DOWN () button until the desired temperature is seen on the display. This temperature will be automatically maintained anywhere between 62°F (17°C) and 86°F (30°C). If you want the display to read the actual room temperature, see "To Operate on Fan Only" section.

AIR CONDITIONER FEATURES

TO ADJUST FAN SPEEDS:

Press  to select the Fan Speed in four steps-Auto, Low, Med or High. Each time the button is pressed, the fan speed mode is shifted.

SLEEP FEATURE:

Press  Sleep button to initiate the sleep mode. In this mode the selected temperature will increase by 2°F/1(or 2)°C 30 minutes after the mode is selected. The temperature will then increase by another 2°F/1(or 2)°C after an additional 30minutes. This new temperature will be maintained for 6 hours before it returns to the originally selected temperature. This ends the Sleep mode and the unit will continue to operate as originally programmed. The Sleep mode program can be cancelled at any time during operation by pressing the Sleep button again.

CHECK FILTER FEATURE:

Press  Check filter button to initiate this feature. This feature is a reminder to clean the Air Filter for more efficient operation. The LED(light) will illuminate after 250 hours of operation. To reset after cleaning the filter, press the Check Filter button and the light will go off.

ENERGY SAVER FEATURE:

Press  Energy saver button to initiate this function. This function is available on COOL, DRY, AUTO (only AUTO-COOLING and AUTO-FAN) modes. The fan will continue to run for 3 minutes after the compressor shuts off. The fan then cycles on for 2 minutes at 10 minute intervals until the room temperature is above the set temperature, at which time the compressor turns back on and Cooling Starts.

FOLLOW ME FEATURE:(on some models)

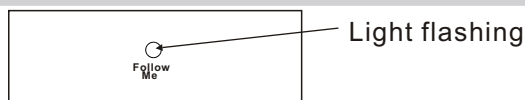

This feature can be activated from the remote control ONLY. The remote control serves as a remote thermostat allowing for the precise temperature control at its location.

To activate the Follow Me feature, point the remote control towards the unit and press the Follow Me button. The remote display is actual temperature at its location. The remote control will send this signal to the air conditioner every 3 minutes interval until press the Follow Me button again. If the unit does not receive the Follow Me signal during any 7 minutes interval, the unit will beep to indicate the Follow Me mode has ended.

TO SELECT THE OPERATING MODE:

To choose operating mode, press  Mode button. Each time you press the button, a mode is selected in a sequence that goes from Auto, Cool, Dry and Fan. The indicator light beside will be illuminated and remained on once the mode is selected.

The unit will initiate automatically the Energy Saver function under Cool, Dry, Auto(only Auto-Cooling and Auto-Fan) modes.

To operate on Auto feature:

- When you set the air conditioner in AUTO mode, it will automatically select cooling, heating(cooling only models without), or fan only operation depending on what temperature you have selected and the room temperature.
- The air conditioner will control room temperature automatically round the temperature point set by you.
- In this mode, the fan speed cannot be adjusted, it starts automatically at a speed according to the room temperature.

To operate on Fan Only:

- Use this function only when cooling is not desired, such as for room air circulation or to exhaust stale air(on some models). (Remember to open the vent during this function, but keep it closed during cooling for maximum cooling efficiency.) You can choose any fan speed you prefer.
- During this function, the display will show the actual room temperature, not the set temperature as in the cooling mode.
- In Fan only mode, the temperature is not adjusted.

To operate on Dry mode:

- In this mode, the air conditioner will generally operate in the form of a dehumidifier. Since the conditioned space is a closed or sealed area, some degree of cooling will continue.

TIMER: AUTO START/STOP FEATURE:

- When the unit is on or off, first press  Timer button, the TIMER ON indicator light illuminates. It indicates the Auto Start program is initiated.
- When the time of TIMER ON is displayed, press the Timer button again, the TIMER OFF indicator light illuminates. It indicates the Auto Stop program is initiated.
- Press or hold the UP or DOWN button to change the Auto time by 0.5 hour increments, up to 10 hours, then at 1 hour increments up to 24 hours. The control will count down the time remaining until start.
- The selected time will register in 5 seconds, and the system will automatically revert back to display the previous temperature setting or room temperature when the unit is on.(when the unit is off, there is no display.)
- Turning the unit ON or OFF at any time or adjusting the timer setting to 0.0 will cancel the Auto Start/Stop timed program.

AIR CONDITIONER FEATURES

DISPLAYS:

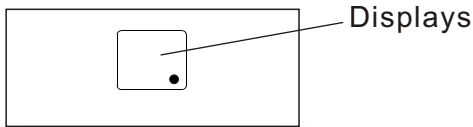

DISPLAYS:

Shows the set temperature in " °C" or " °F" and the Auto-timer settings. While on Fan only mode, it shows the room temperature.

Error codes:

AS-Room temperature sensor error-Unplug the unit and plug it back in.If error repeats, call for service.
NOTE:In Fan only mode,it will display "LO" or "HI".

- -Evaporator temperature sensor error-Unplug the unit and plug it back in.If error repeats, call for service.
NOTE: "•" is displayed as shown in the left picture.

HS -Electric heating sensor error-Unplug the unit and plug it back in.If error repeats, call for service.

NOTE:

If the unit breaks off unexpectedly due to the power cut, it will restart with the previous function setting automatically when the power resumes.

Air Directional Louvers

4-Way Louvers

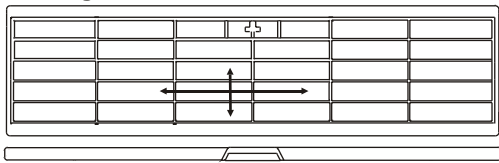

The 4-Way air directional louvers allow you to direct air flow up or horizontal, left or right throughout the room as needed. To adjust the air directional louvers side-to-side, use the center handle as you move it side-to-side.

ADDITIONAL THINGS YOU SHOULD KNOW

Now that you have mastered the operating procedure, here are more features in your control that you should become familiar with.

- The Cool circuit has an automatic 3 minute time delayed start if the unit is turned off and on quickly. This prevents overheating of the compressor and possible circuit breaker tripping. The fan will continue to run during this time.
- The control is capable of displaying temperature in degrees Fahrenheit or degrees Celsius. To convert from one to the other, press and hold the Left and Right Temp/Timer buttons at the same time, for 3 seconds.

Exhaust Control

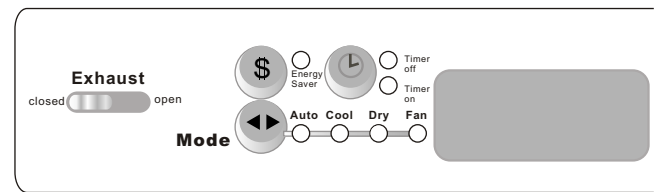

This Exhaust Control allows the air conditioner to either circulate inside air (Closed) or exhaust air to the outside (Open).

The Closed position is used when maximum cooling is desired. It may also be used for air recirculation without cooling when the air conditioner is set in any FAN position.

The Open position removes stale air from the room and exhausts it to the outside. Fresh air is drawn in through normal passages in the home.

CARE AND CLEANING

CAUTION

Clean your air conditioner occasionally to keep it looking new. **Be sure to unplug the unit before cleaning to prevent shock or fire hazards.**

Air Filter Cleaning

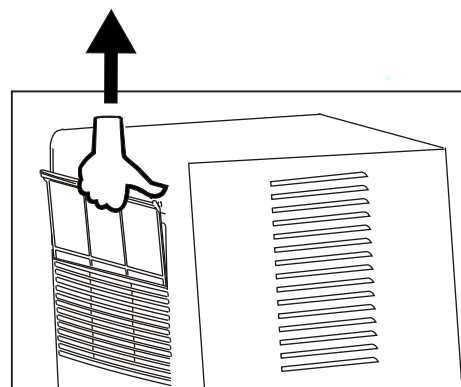

The air filter should be checked at least once a month to see if cleaning is necessary. Trapped particles in the filter can build up and cause an accumulation of frost on the cooling coils.

CARE AND CLEANING

Air Filter Cleaning

- Take the filter by the center and pull up and out.
- Wash the filter using liquid dishwashing detergent and warm water. Rinse filter thoroughly. Gently shake excess water from the filter. Be sure the filter is thoroughly dry before replacing. Or, instead of washing you may vacuum the filter clean.

Note: Never use hot water over 40°C(104°F) to clean the air filter. Never attempt to operate the unit without the air filter.

NOTE:

To prevent rust or electrical connections from being damaged, store air conditioner in an upright position and in a dry place.

Cabinet Cleaning

- Be sure to unplug the air conditioner to prevent shock or fire hazard. The cabinet and front may be dusted with an oil-free cloth or washed with a cloth dampened in a solution of warm water and mild liquid dishwashing detergent. Rinse thoroughly and wipe dry.
- Never use harsh cleaners, wax or polish on the cabinet front.
- Be sure to wring excess water from the cloth before wiping around the controls. Excess water in or around the controls may cause damage to the air conditioner.
- Plug in air conditioner.

Winter Storage

If you plan to store the air conditioner during the winter, remove it carefully from the window according to the installation instructions. Cover it with plastic or return it to the original carton.

TROUBLESHOOTING TIPS

Before calling for service, review this list. It may save your time and expense. This list includes common occurrences that are not the result of defective workman-ship or materials in this appliance.

Problem	Solution
Air conditioner does not start	<i>Wall plug disconnected. Push plug firmly into wall outlet.</i>
	<i>House fuse blown or circuit breaker tripped. Replace fuse with time delay type or reset circuit breaker.</i>
	<i>Plug Current Device Tripped. Press the RESET button.</i>
	<i>Power is OFF. Turn power ON.</i>
Air from unit does not feel cold enough	<i>Room temperature below 62°F(17°C). Cooling may not occur until room temperature rises above 62°F(17°C).</i>
	<i>Temperature sensing behind air filter element touching cold coil. Keep it from the cold coil.</i>
	<i>Set to a Lower temperature.</i>
	<i>Compressor stopped when changing modes. Wait for 3 minutes after set to the COOL mode.</i>
Air conditioner cooling, but room is too warm- ice forming on cooling coil behind decorative front.	<i>Outdoor temperature below 64°F(18°C). To defrost the coil, set FAN ONLY mode.</i>
	<i>Air filter may be dirty. Clean filter. Refer to Care and Cleaning section. To defrost, set to FAN ONLY mode.</i>
	<i>Thermostat set too cold for night-time cooling. To defrost the coil, set to FAN ONLY mode. Then, set temperature to a Higher setting.</i>

TROUBLESHOOTING TIPS

Problem	Solution
Air conditioner cooling, but room is too warm- NO ice forming on cooling coil behind decorative front.	<i>Dirty air filter- air restricted. Clean air filter. Refer to Care and Cleaning section.</i>
	<i>Temperature is set too High, set temperature to a Lower setting.</i>
	<i>Air directional louvers positioned improperly. Position louvers for better air distribution.</i>
	<i>Front of units is blocked by drapes, blinds, furniture, etc. - restricts air distribution. Clear blockage in front of unit.</i>
	<i>Doors, windows, registers, etc. Open- cold air escapes. Close doors, windows, registers.</i>
	<i>Unit recently turned on in hot room. Allow additional time to remove " Stored heat" from walls, ceiling, floor and furniture.</i>
Air conditioner turns on and off rapidly	<i>Dirty air filter- air restricted. Clean air filter.</i>
	<i>Outside temperature extremely hot. Set FAN speed to a Higher setting to bring air past cooling coils more frequently.</i>
Noise when unit is cooling	<i>Air movement sound. This is normal . If too loud, set to a slower FAN setting.</i>
	<i>Window vibration - poor installation. Refer to installation instructions or check with installer.</i>
Water dripping INSIDE when unit is cooling.	<i>Improper installation. Tilt air conditioner slightly to the outside to allow water drainage. Refer to installation instructions - check with installer.</i>
Water dripping OUTSIDE when unit is cooling.	<i>Unit removing large quantity of moisture from humid room. This is normal during excessively humid days.</i>
Remote Sensing Deactivating Prematurely (some models)	<i>Remote control not located within range. Place remote control within 20 feet & 180°, radius of the front of the unit.</i>
	<i>Remote control signal obstructed. Remove obstruction.</i>
Room too cold	<i>Set temperature too low. Increase set temperature.</i>

The design and specifications are subject to change without prior notice for product improvement. Consult with the sales agency or manufacturer for details.