

INSTALLATION INSTRUCTIONS

1 PREPARE THE WINDOW

Lower sash must open sufficiently to allow a clear vertical opening of 13 inches (330mm). Side louvers and the rear of the AC must have clear air space to allow enough airflow through the condenser, for heat removal. The rear of the unit must be outdoors, not inside a building or garage.

Mounting Hardware

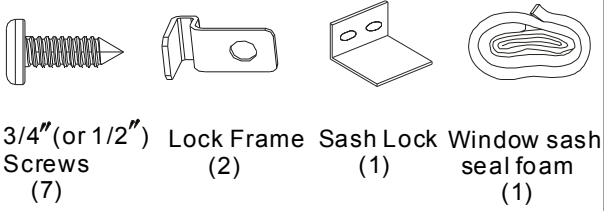

C: Align the hole in the top rail with those in the top of the unit as shown in Fig.B

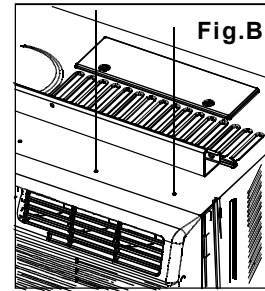

D: Secure the top rail to the unit with the 3/8" Screws as shown in Fig.C.

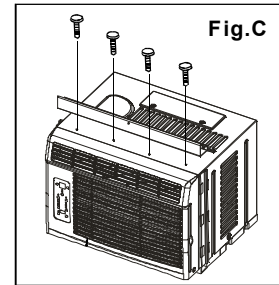

NOTE: For safety reasons, all four(4) screws MUST be securely fastened.

2 PREPARE AIR CONDITIONER

A: Remove the air conditioner from the carton and place on a flat surface.

B: Remove top rail from the rear of the packaging material as shown in Fig. A.

Top Rail Hardware

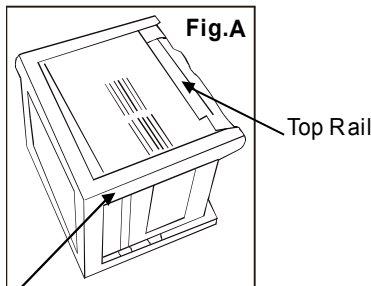
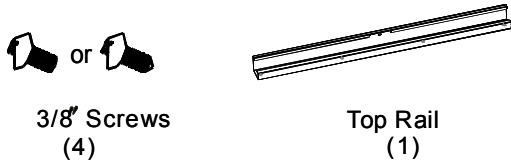

Packaging

3 INSTALL THE ACCORDION PANELS

NOTE: Top rail and Sliding Panels at each side are offset to provide the proper pitch to the rear of (5/16"). This is necessary for proper condensed water utilization and drainage. If you are not using the Side Panels for any reason, this pitch to the rear must be maintained.

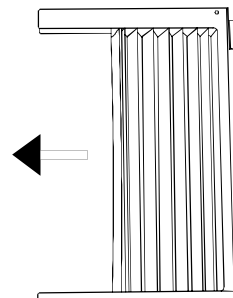

A. Place unit on floor, a bench or a table. Hold the Accordion Panel in one hand and gently pull back the center to free the open end. See Fig. 1

Fig.1

INSTALLATION INSTRUCTIONS

- B. Slide the free end " I " section of the panel directly into the cabinet as shown in Fig. 2. Slide the panel down. Be sure to leave enough space to slip the top and bottom of the frame into the rails on the cabinet.

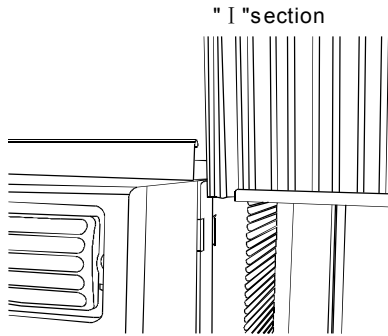

Fig. 2

- C. Once the panel has been installed on the side of the cabinet, make sure it sits securely inside the frame channel by making slight adjustments. Slide the top and bottom ends of the frame into the top and bottom rails of the cabinet. Fig. 3.

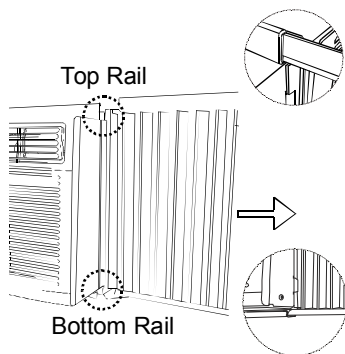
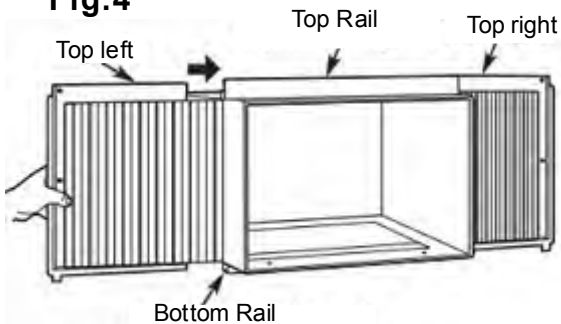

Fig. 3

- D. Slide the panel all the way in and repeat on the other side.

Fig. 4



NOTE: If storm window blocks AC, see Fig. 11.

4 SECURE THE ACCORDION PANELS

- A. Keep a firm grip on the air conditioner, carefully place the unit into the window opening so the bottom of the air conditioner frame is against the window sill (Fig. 5). Carefully close the window behind the top rail of the unit.

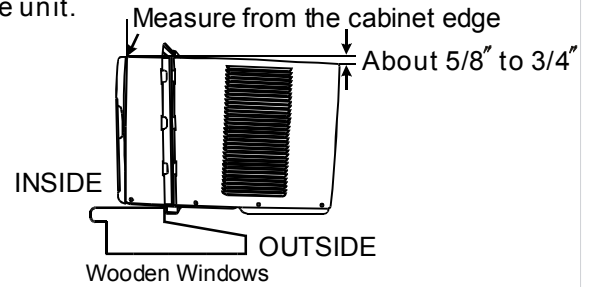

Fig. 5

NOTE: Check that air conditioner is tilted back about $5/8''$ to $3/4''$ (tilted about 3° to 4° downward to the outside). After proper installation, condensate should not drain from the overflow drain hole during normal use, correct the slope otherwise.

- B. Extend the side panels out against the window frame (Fig. 6).

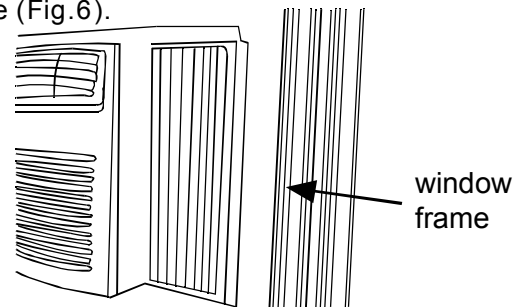

Fig. 6

5 INSTALL SUPPORT BRACKET

- A. Place the frame lock between the frame extensions and the window sill as shown (Fig. 7). Drive $3/4''$ (19mm) or $1/2''$ (12.7mm) locking screws through the frame lock and into the sill.

NOTE: To prevent window sill from splitting, drill $1/8''$ (3mm) pilot holes before driving screws.

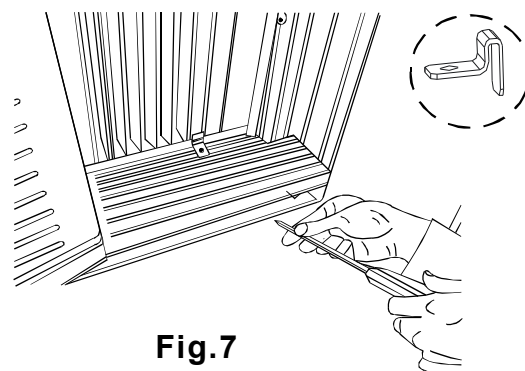

Fig. 7

INSTALLATION INSTRUCTIONS

B. Drive 3/4" (19mm) or 1/2" (12.7mm) locking screws through frame holes into window sash (Fig.8).

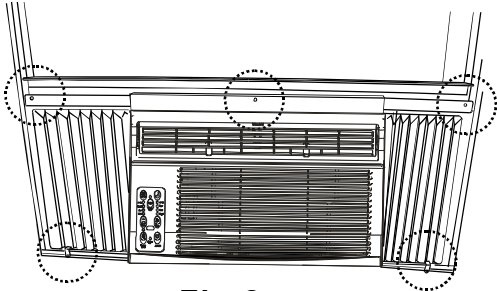

Fig.8

C. To secure lower sash in place, attach right angle sash lock with 3/4" (19mm) or 1/2" (12.7mm) screw as shown(Fig.9).



Fig.9

D. Cut Window sash seal foam and insert it in the space between the upper and lower sashes (Fig.10).

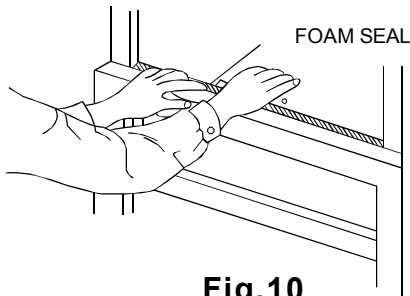

Fig.10

If AC is Blocked by Storm Window

Add wood as shown in Fig. 11, or remove storm window before air conditioner is installed.

If Storm Window Frame must remain, be sure the drain holes or slots are not caulked or painted shut. Accumulated Rain Water or Condensation must be allowed to drain out.

Removing AC From Window

- ◆ Turn AC off, and disconnect power cord.
- ◆ Remove sash seal from between windows, and unscrew safety sash lock.
- ◆ Remove screws installed through frame and frame-lock.
- ◆ Close (slide) side panels into frame.
- ◆ Keeping a firm grip on air conditioner, raise sash and carefully remove.
- ◆ Be carefully not to spill any remaining water while lifting unit from window. Store parts WITH air conditioner.

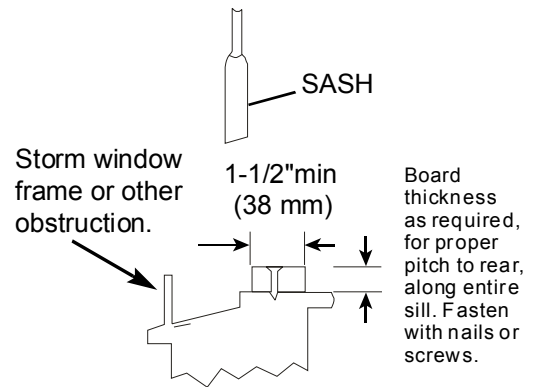

Fig.11