

INSTALLATION INSTRUCTIONS



BEFORE YOU BEGIN

Read these instructions completely and carefully.

IMPORTANT- Save these instructions for local inspector's use.

IMPORTANT- Observe all governing codes and ordinances. **Note to Installer-** Be sure to leave these instructions with the Consumer.

Note to Consumer- Keep these instructions for future reference.

Skill level- Installation of this appliance requires basic mechanical skills.

Completion time- Approximately 1 hour. We recommend that two people install this product.

Proper installation is the responsibility of the installer.

Product failure due to improper installation is not covered under the Warranty.

You **MUST** use all supplied parts and use proper installation procedures as described in these instructions when installing this air conditioner.

CAUTION

Do not, under any circumstances, cut or remove the third (ground) prong from the power cord.

Do not change the plug on the power cord of the air conditioner.

Aluminum house wiring may present special problems- consult a qualified electrician.

When handling unit, be careful to avoid cuts from sharp metal edges and aluminum fins on front and rear coils.

Do This First (for existing sleeve)

Note that the air conditioner dimensions are: 24 inches wide, 14 inches high, and 18 inches deep (without front). Install Air Conditioner according to these installation instructions to achieve the best performance. Save these installation instructions for future reference.

NOTE: Do not use any screws other than those specified here.

Items in Kit

You may not need all parts in the kit. Discard unused parts.

Name	Spec.	Qty
Tapered Spacer Blocks	17" Long	2
Centering/Support Blocks	4 1/2" x 3 1/2" x 1 1/2"	4
Plastic Divider	1/8" x 4 1/2" x 14 1/2"	2
Stuffer Seal	1" x 1 1/2" x 84"	1
Seal	1" x 1 1/2" x 25"	3
Seal	1" x 1 1/2" x 14"	2
Seal	1" x 3/8" x 25"	3
Seal	1" x 3/8" x 14"	2
Seal	1" x 3/4" x 14"	2
Trim Frame (side legs)		2
Trim Frame (top & bottom legs)		2
Ground Wire (green)		1
Toothed Washer for grounding screw		2
Grounding Screw		1
Grille (plastic)		1
Grille Aluminum		1
Nuts (plastic)		4
Screw Washer		4
Screw		4



NOTE:

Save Carton and these Installation Instructions for future reference. The carton is the best way to store unit during winter, or when not in use.

INSTALLATION INSTRUCTIONS

How to Install

1. Identify the wall-sleeve brand for your installation, from the chart below.

Brand	Wall Sleeve Dimensions (inches)		
	Width	Height	Depth
White-Westinghouse Frigidaire } Carrier(52F Series)	25 $\frac{1}{2}$	15 $\frac{1}{4}$	16, 17 $\frac{1}{2}$ or 22
General Electric/Hotpoint	26	15 $\frac{5}{8}$	15 $\frac{7}{8}$
Whirlpool	25 $\frac{7}{8}$	16 $\frac{1}{2}$	17 $\frac{1}{8}$ or 23
Fedders/Emerson	27	16 $\frac{3}{4}$	16 $\frac{3}{4}$ or 19 $\frac{3}{4}$
Sears/Kenmore } Carrier(51S Series)	25 $\frac{3}{4}$	16 $\frac{7}{8}$	18 $\frac{5}{8}$
Emerson/Fedders	26 $\frac{3}{4}$	15 $\frac{3}{4}$	15
Friedrich	27	16 $\frac{3}{4}$	16 $\frac{3}{4}$

NOTE: All wall sleeves used to mount the new Air Conditioner must be in sound structural condition and have a rear grille that securely attaches to sleeve, or rear flange that serves as a stop for the Air Conditioner.

CAUTION: When installation is complete, replacement unit **MUST** have a rearward slope as shown.

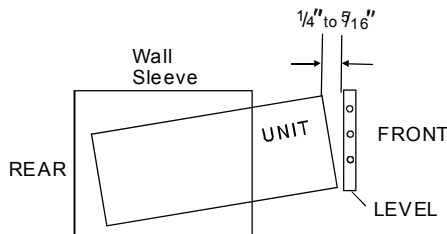

2. Remove old Air Conditioner from wall sleeve and prepare wall sleeve as follows:

- Clean interior (do not disturb seals).
- Wall sleeve must be securely fastened in wall before installing Air Conditioner.
Drive more nails or screws through sleeve, into wall, if needed.
- Repair paint if needed.

3. If not existing, drill a 1/8" clearance hole for grounding screw through left side of wall sleeve, in a clear area about 3 inches maximum back from front edge of sleeve, using grounding screw and toothed washer. Pull loose end of ground wire out front of sleeve, and temporarily bend it down and around lower edge of sleeve. This ground wire will later be attached to frame of air conditioner once it is installed.

Wall sleeve to unit sleeve grounding

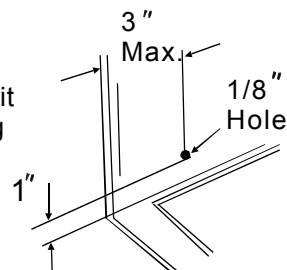

4. Prepare the wall sleeve for installation of the new unit per the following Brand instructions.

- | | |
|--|-----------------------------|
| #1 Emerson | 15" Deep |
| #2 Fedders | 19 $\frac{3}{4}$ " Deep |
| #3 Fedders or Friedrich | 16 $\frac{3}{4}$ " Deep |
| #4 General Electric/Hotpoint | 16 $\frac{7}{8}$ " Deep |
| #5 Sears or Carrier(51S Series) | 18 $\frac{5}{8}$ " Deep |
| #6 Whirlpool | 17 $\frac{1}{8}$ " Deep |
| #7 Whirlpool | 23" Deep |
| #8 White-Westinghouse/
Frigidaire/Carrier(52F Series) | 16"+17 $\frac{1}{2}$ " Deep |
| #9 White-Westinghouse/Frigidaire | 22" Deep |

5. Identify your wall sleeve type and follow the instructions for that type in the following pages.

INSTALLATION INSTRUCTIONS

IMPORTANT

- This unit's increased performance characteristics result from having two rear air intakes.
- It is very important that these installation instructions are followed so your unit can operate at maximum efficiency.
- If this is an existing sleeve, and there is an existing rear grille, it needs to be replaced by one that has been shipped with the unit in the accessory kit.

FOR INCREASED EFFICIENCY, UTILIZE THE PROVIDED LOUVERED REAR PANEL

Installation of new grille provided with unit

1. Remove the existing grille.
2. Place the grille included with the new air conditioner towards the rear of the sleeve.
3. Mark through the hole positions.
4. Drill through the sleeves flanges with a 1/8" drill bit.
5. Attached the new grille with self-threading screws and washers.
6. It is VERY IMPORTANT that the grille is placed exactly as shown below.
7. Most decorative exterior grilles may be left in place as long as the proper interior air direction grille is installed.

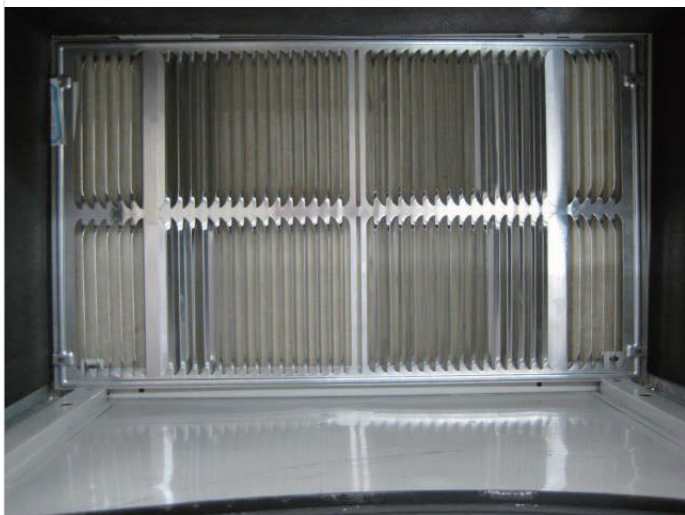

INSTALLATION INSTRUCTIONS

Wall Sleeve Brands:

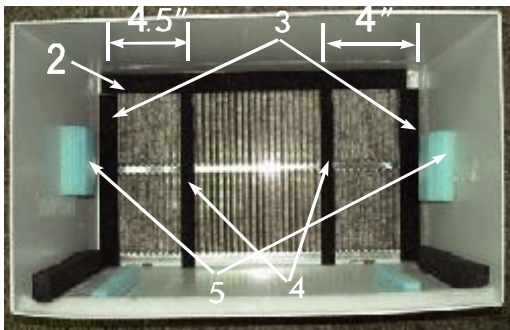
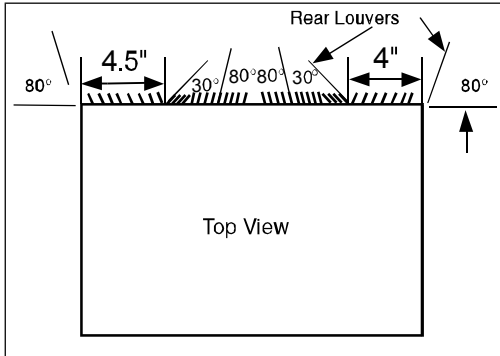

#1 Emerson

15' Deep

1. Remove existing rear grille as shown on Page 6 of this manual and replace with provided louvered rear panel. Install as shown here.

NOTE: You may need to drill holes in flange of existing sleeve to match new rear grille.

2. Attach (1) 1" x 3/8" x 25" long seal in the center at the top of the sleeve. Remove the backing paper and press into position.
3. Attach the (2) 1" x 3/8" x 14" long seals to the left and right sides of the sleeve.
4. Cut (2) 1" x 3/8" x 25" long seals to 14" long, and attach it to the vertical sections of the rear grille as shown.
5. Attach (2) 4 1/2" x 3 1/2" x 1 1/2" centering/support blocks one on each side wall. Place in center of side wall with the tapered end facing the opening.
6. Gently slide unit into sleeve.
7. Before sliding all-the-way back, remove 2nd screw from front on left side of unit.
8. Remove the plastic washer from the screw.
9. Screw and attach the other end of the ground wire to the unit as shown in picture. Make sure that the toothed washer is against the cabinet.
10. Slide the unit completely to the rear to ensure a good seal, making sure the ground wire does not become tangled.
11. Seal & Frame the unit as described on page 17.
12. If you have difficulty with mounting the grill to the sleeve, follow the instructions for direct mounting on Page 16.

INSTALLATION INSTRUCTIONS

Wall Sleeve Brands:

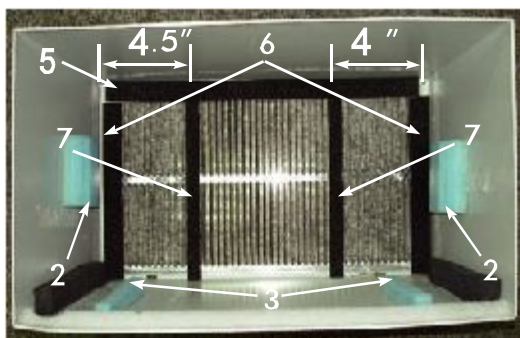
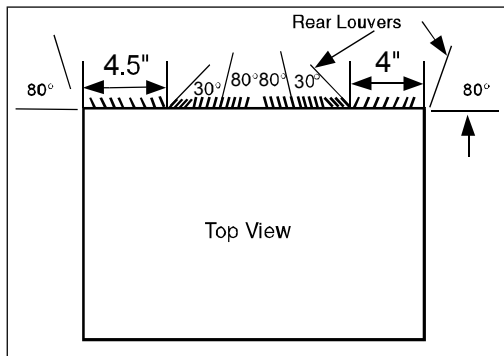

#2 Fedders

19³/₄" Deep

1. Remove existing rear grille as shown on Page 6 of this manual and replace with provided louvered rear panel. Install as shown here.

NOTE: You may need to drill holes in flange of existing sleeve to match new rear grille.

2. Attach (2) 4¹/₂" x 3¹/₂" x 1¹/₂" centering/support blocks one on each side wall. Place in center of side wall with the tapered end facing the opening.
3. Cut (2) 17" Tapered Spacer Blocks as shown below into two pieces.

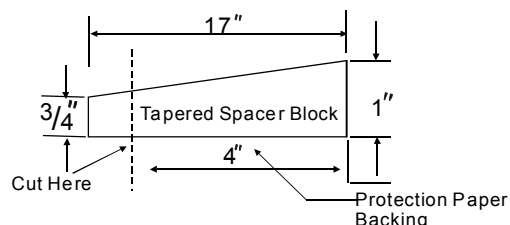

4. The 4" section is placed in front of the rib on base with the tapered end facing the back of the sleeve. The remaining portion will be placed behind the rib again sloping toward the rear of the sleeve. This helps induce a rearward slope on the unit.
5. Attach (1) 1" x 3/8" x 25" long seal in the center at the top of the sleeve. Remove the backing paper and press into position.
6. Attach (2) 1" x 3/8" x 14" seals to the left and right sides of the sleeve.
7. Cut (2) 1" x 3/8" x 25" long seals to 14" long and attach it to the vertical sections of the rear grille as shown.
8. Gently slide unit into sleeve.
9. Before sliding all-the-way back, remove 2nd screw from front on left side of unit.
10. Remove the plastic washer from the screw.
11. Screw and attach the other end of the ground wire to the unit as shown in picture. Make sure that the toothed washer is against the cabinet.
12. Slide the unit completely to the rear to ensure a good seal, making sure the ground wire does not become tangled.
13. Seal & Frame the unit as described on page 17.
14. If you have difficulty with mounting the grill to the sleeve, follow the instructions for direct mounting on Page 16.

INSTALLATION INSTRUCTIONS

Wall Sleeve Brands:

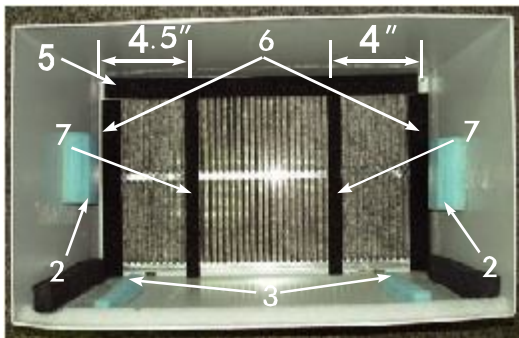
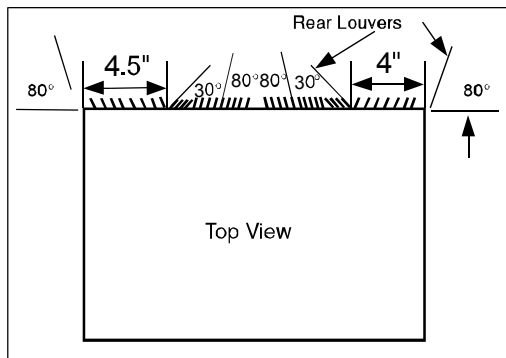

#3 Fedders or Friedrich 16^{3/4}" Deep

1. Remove existing rear grille as shown on Page 6 of this manual and replace with provided louvered rear panel. Install as shown here.

NOTE: You may need to drill holes in flange of existing sleeve to match new rear grille.

2. Attach (2) 4^{1/2}" x 3^{1/2}" x 1^{1/2}" centering/support blocks one on each side wall. Place in center of side wall with the tapered end facing the opening.
3. Cut (2) 17" Tapered Spacer Blocks as shown below into three pieces.

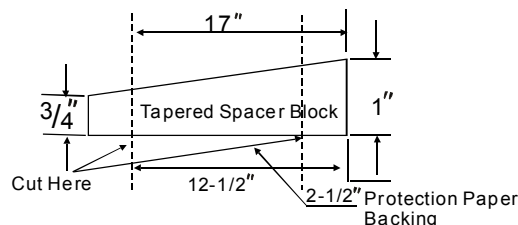

4. The 2 1/2" section is placed in front of the rib on base with the tapered end facing the back of the sleeve. Cut the remaining portion to 12 1/2" and placed behind the rib again sloping toward the rear of the sleeve. This helps induce a rearward slope on the unit.
5. Attach (1) 1" x 3/8" x 25" long seal in the center at the top of the sleeve. Remove the backing paper and press into position.
6. Attach (2) 1" x 3/8" x 14" seals to the left and right sides of the sleeve.
7. Cut (2) 1" x 3/8" x 25" long seals to 14" long and attach it to the vertical sections of the rear grille as shown.
8. Gently slide unit into sleeve.
9. Before sliding all-the-way back, remove 2nd screw from front on left side of unit.
10. Remove the plastic washer from the screw.
11. Screw and attach the other end of the ground wire to the unit as shown in picture. Make sure that the toothed washer is against the cabinet.
12. Slide the unit completely to the rear to ensure a good seal, making sure the ground wire does not become tangled.
13. Seal & Frame the unit as described on page 17.
14. If you have difficulty with mounting the grill to the sleeve, follow the instructions for direct mounting on Page 16.

INSTALLATION INSTRUCTIONS

Wall Sleeve Brands:

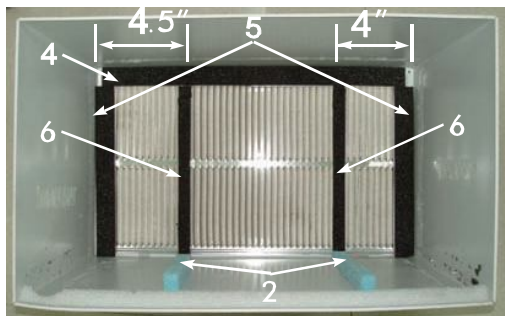
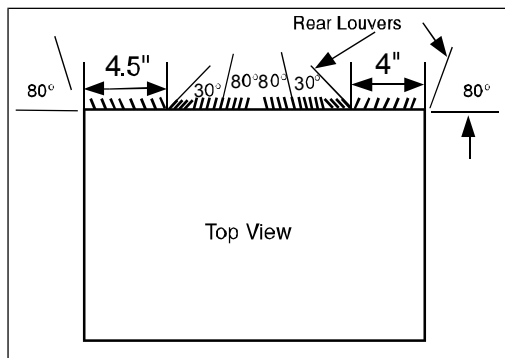

#4 General Electra/Hotpoint 16⁷/₈" Deep

1. Remove existing rear grille as shown on Page 6 of this manual and replace with provided louvered rear panel. Install as shown here.

NOTE: You may need to drill holes in flange of existing sleeve to match new rear grille.

2. Cut (2) 17" Tapered Spacer Blocks as shown below into two pieces.

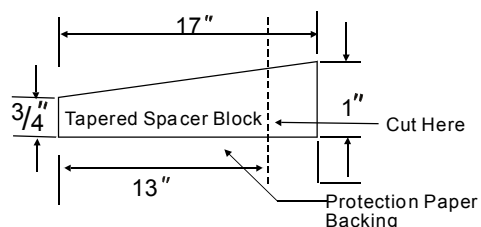

3. Install 13" section as shown with the tapered end $\frac{1}{2}$ from the back of the sleeve. This helps induce a rearward slop on the unit.
4. Attach (1) 1" x 3/8" x 25" long seal in the center at the top of the sleeve. Remove the backing paper and press into position.
5. Attach (2) 1" x 3/8" x 14" seals to the left and right sides of the sleeve.
6. Cut (2) 1" x 3/8" x 25" long seals to 14" long and attach it to the vertical sections of the rear grille as shown.
7. Center unit and gently slide unit into sleeve.
8. Before sliding all-the-way back, remove 2nd screw from front on left side of unit.
9. Remove the plastic washer from the screw.
10. Screw and attach the other end of the ground wire to the unit as shown in picture. Make sure that the toothed washer is against the cabinet.
11. Slide the unit completely to the rear to ensure a good seal, making sure the ground wire does not become tangled.
12. Seal & Frame the unit as described on page 17.
13. If you have difficulty with mounting the grill to the sleeve, follow the instructions for direct mounting on Page 16.

INSTALLATION INSTRUCTIONS

Wall Sleeve Brands:

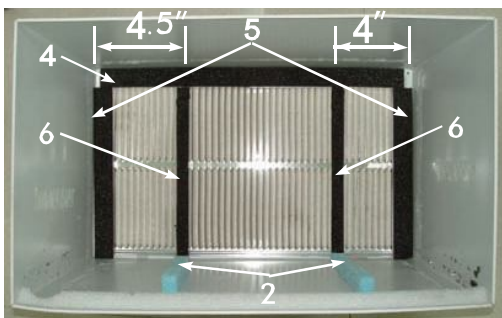
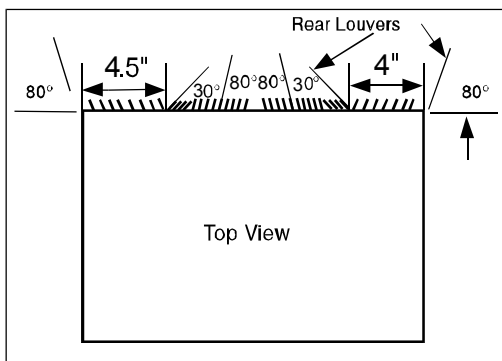

#5 Sears or Carrier 51S Series (18⁵/₈" Deep)

1. Remove existing rear grille as shown on Page 6 of this manual and replace with provided louvered rear panel. Install as shown here.

NOTE: You may need to drill holes in flange of existing sleeve to match new rear grille.

2. Install (2) tapered spacer blocks to the floor of the sleeve as shown. This helps induce a rearward slop on the unit.
3. Install as shown with the tapered end $\frac{1}{2}$ " from the back of the sleeve. This helps induce a rearward slop on the unit.
4. Attach (1) 1" x 3/8" x 25" long seal in the center at the top of the sleeve. Remove the backing paper and press into position.
5. Attach (2) 1" x 3/8" x 14" seals to the left and right sides of the sleeve.
6. Cut (2) 1" x 3/8" x 25" long seals to 14" long and attach it to the vertical sections of the rear grille as shown.
7. Center unit and gently slide unit into sleeve.
8. Before sliding all-the-way back, remove 2nd screw from front on left side of unit.
9. Remove the plastic washer from the screw.
10. Screw and attach the other end of the ground wire to the unit as shown in picture. Make sure that the toothed washer is against the cabinet.
11. Slide the unit completely to the rear to ensure a good seal, making sure the ground wire does not become tangled.
12. Seal & Frame the unit as described on page 17.
13. If you have difficulty with mounting the grill to the sleeve, follow the instructions for direct mounting on Page 16.

INSTALLATION INSTRUCTIONS

Wall Sleeve Brands:

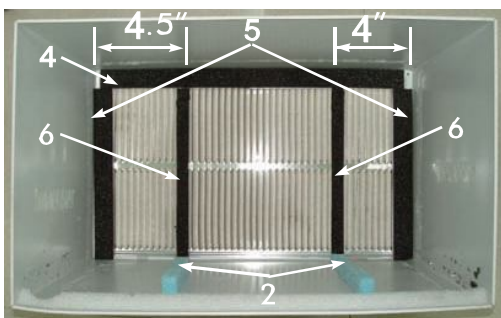
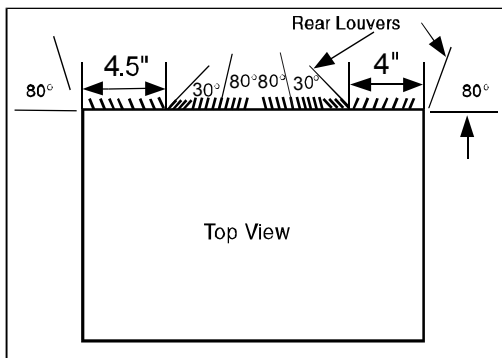

#6 Whirlpool 17¹/₈" Deep

1. Remove existing rear grille as shown on Page 6 of this manual and replace with provided louvered rear panel. Install as shown here.

NOTE: You may need to drill holes in flange of existing sleeve to match new rear grille.

2. Cut (2) 17" Tapered Spacer Blocks as shown below into two pieces.

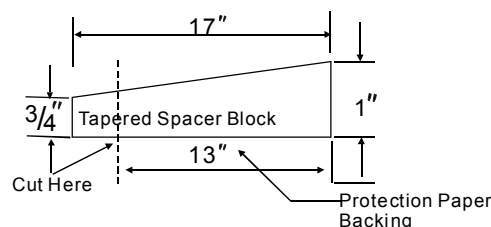

3. Install 13" section to the floor of the sleeve as shown. This helps induce a rearward slop on the unit.
4. Attach (1) 1" x 3/8" x 25" long seal in the center at the top of the sleeve. Remove the backing paper and press into position.
5. Attach (2) 1" x 3/8" x 14" seals to the left and right sides of the sleeve.
6. Cut (2) 1" x 3/8" x 25" long seals to 14" long and attach it to the vertical sections of the rear grille as shown.
7. Center unit and gently slide unit into sleeve.
8. Before sliding all-the-way back, remove 2nd screw from front on left side of unit.
9. Remove the plastic washer from the screw.
10. Screw and attach the other end of the ground wire to the unit as shown in picture. Make sure that the toothed washer is against the cabinet.
11. Slide the unit completely to the rear to ensure a good seal, making sure the ground wire does not become tangled.
12. Seal & Frame the unit as described on page 17.
13. If you have difficulty with mounting the grill to the sleeve, follow the instructions for direct mounting on Page 16.

INSTALLATION INSTRUCTIONS

Wall Sleeve Brands:

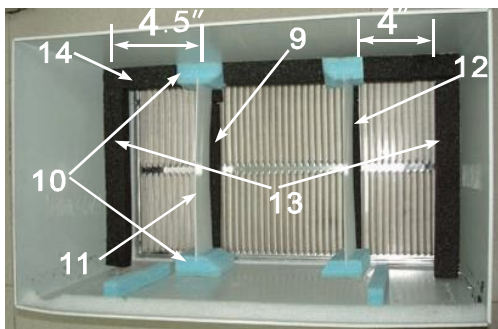
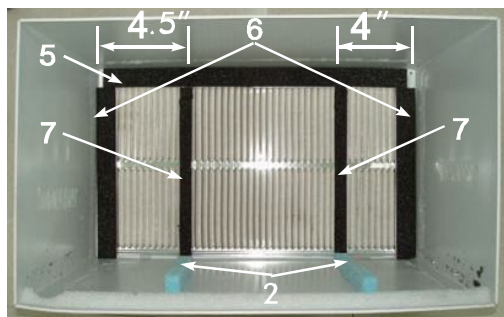
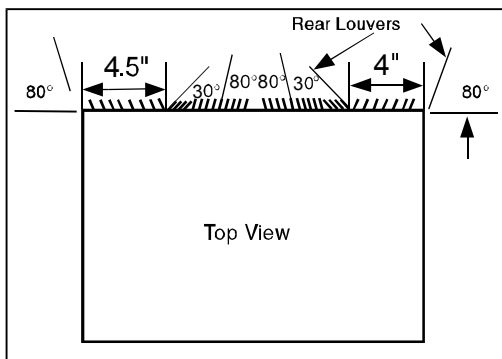

#7 Whirlpool (23" Deep)

1. Remove existing rear grille as shown on Page 6 of this manual and replace with provided louvered rear panel. Install as shown here.

NOTE: You may need to drill holes in flange of existing sleeve to match new rear grille.

Because of the increased unit depth, first try dry fitting using the method described below:

2. Place (2) 1" x 1½" x 14" seals against each side.
3. Gently slide unit in and check if amount extending from the sleeve is sufficient once the trim frame is attached.
4. If position is Ok, remove unit and proceed to the next step. If not go to step 9.
5. Attach (1) 1" x 1½" x 25" long seal in the center at the top of the sleeve. Remove the backing paper and press into position.
6. Attach (2) 1" x 1½" x 14" seals to the left and right sides of the sleeve.
7. Cut (2) 1" x ¾" x 25" long seals to 14" long and attach to the vertical sections of the grille as shown.
8. Attach the tapered spacer blocks to the floor of the sleeve. Now go to step 15.

Use these next steps if the unit requires extra extension into the room.

9. Attach 1" x ¾" x 14" long seal over the solid vertical portion of the rear grille.
10. Attach (2) 4¾" x 3¾" x 1¼" foam blocks with the slot overlapping the seal above.
11. Install the divider into the slots of the foam blocks. You may need to trim the length to size.
12. Repeat steps 9-11 for the other vertical shown portion of the grille as shown in the picture.
13. Attach (2) 1" x 1½" x 14" seals along the sides of the sleeve again making sure all seals are flush.
14. Cut the 1" x 1½" x 25" seal to fit the top of the sleeve. The pieces must be fitted flush to the edge of the divider.
15. Center unit and gently slide unit into sleeve.
16. Before sliding all-the-way back, remove 1st screw from front on left side of unit.
17. Remove the plastic washer from the screw.
18. Screw and attach the other end of the ground wire to the unit as shown in picture. Make sure that the toothed washer is against the cabinet.
19. Slide the unit completely to the rear to ensure a good seal, making sure the ground wire does not become tangled.
20. Seal & Frame the unit as described on page 17.
21. If you have difficulty with mounting the grill to the sleeve, follow the instructions for direct mounting on Page 16.

INSTALLATION INSTRUCTIONS

Wall Sleeve Brands:

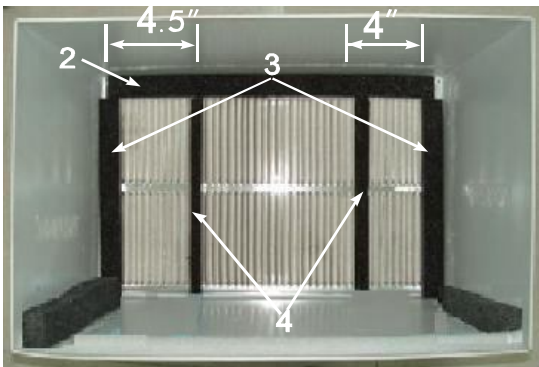
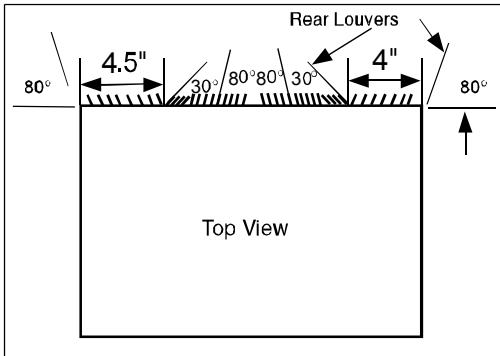

#8 White Westinghouse/Frigidaire/ Carrier 52F Series (16" + 17 1/2" Deep)

1. Remove existing rear grille as shown on Page 6 of this manual and replace with provided louvered rear panel. Install as shown here.

NOTE: You may need to drill holes in flange of existing sleeve to match new rear grille.

2. Attach (1) 1" x 3/8" x 25" long seal in the center at the top of the sleeve. Remove the backing paper and press into position.
3. Attach (2) 1" x 3/8" x 14" seals to the left and right sides of the sleeve.
4. Attach (2) 1" x 3/4" x 14" long seals vertically 4.5" from the left side of the sleeve. Attach the other 1" x 3/4" x 14" long seal 4" from the right side of the sleeve.
5. Center unit and gently slide unit into sleeve.
6. Before sliding all-the-way back, remove 2nd screw from front on left side of unit.
7. Remove the plastic washer from the screw.
8. Screw and attach the other end of the ground wire to the unit as shown in picture. Make sure that the toothed washer is against the cabinet.
9. Slide the unit completely to the rear to ensure a good seal, making sure the ground wire does not become tangled.
10. Seal & Frame the unit as described on page 17.
11. If you have difficulty with mounting the grill to the sleeve, follow the instructions for direct mounting on Page 16.

INSTALLATION INSTRUCTIONS

Wall Sleeve Brands:

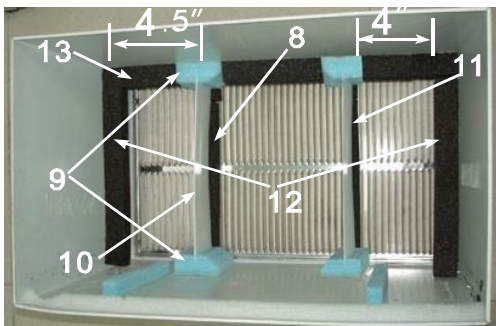
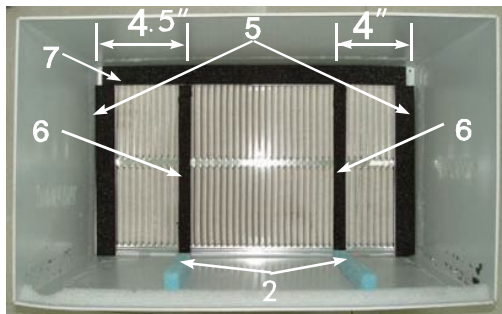
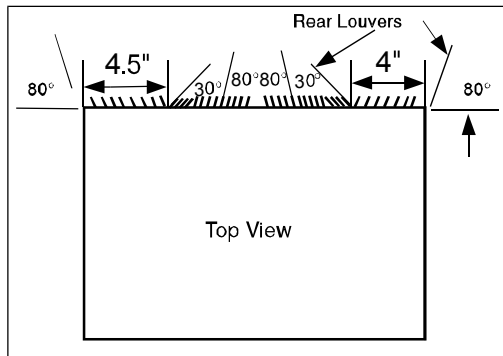

#9 White Westinghouse or Frigidaire (22" Deep)

1. Remove existing rear grille as shown on Page 6 of this manual and replace with provided louvered rear panel. Install as shown here.

NOTE: You may need to drill holes in flange of existing sleeve to match new rear grille.

Because of the increased unit depth, first try dry fitting using the method described below:

2. Place (2) 1" x 1½" x 14" seals against each side.
3. Gently slide unit in and check if amount extending from the sleeve is sufficient once the trim frame is attached.
4. If position is Ok, remove unit and proceed to the next step. If not go to step 8.
5. Attach (1) 1" x 1½" x 15" long seal to the left and right sides of the sleeve.
6. Cut (1) 1" x 1½" x 25" long seal to 14" long and attach it vertically to the rear grille 4.5" from the left side, repeat and attach 4" from the right side.
7. Attach (1) 1" x 1½" x 25" long seal in the center at the top of the sleeve. Remove the backing paper and press into position. Proceed to step 14.

Use these next steps if the unit requires extra extension into the room.

8. Attach 1" x ¾" x 14" long seal over the solid vertical portion of the rear grille.
9. Attach (2) 4¾" x 3¾" x 1¾" foam blocks with the slot overlapping the seal above.
10. Install the divider into the slots of the foam blocks. You may need to trim the length to size.
11. Repeat steps 8-10 for the other vertical shown portion of the grille as shown in the picture.
12. Attach (2) 1" x 1½" x 14" seals along the sides of the sleeve again making sure all seals are flush.
13. Cut the 1" x 1½" x 25" seal to fit the top of the sleeve. The pieces must be fitted flush to the edge of the divider.
14. Center unit and gently slide unit into sleeve.
15. Before sliding all-the-way back, remove 1st screw from front on left side of unit.
16. Remove the plastic washer from the screw.
17. Screw and attach the other end of the ground wire to the unit as shown in picture. Make sure that the toothed washer is against the cabinet.
18. Slide the unit completely to the rear to ensure a good seal, making sure the ground wire does not become tangled.
19. Seal & Frame the unit as described on page 17.
20. If you have difficulty with mounting the grill to the sleeve, follow the instructions for direct mounting on Page 16.

INSTALLATION INSTRUCTIONS

Direct Unit Mounting:

The previous directions are the preferable way to mount the new rear grill. The unit's performance is slightly better and the possibility of draughts is reduced. As a last resort, direct mounting of the grille to the unit can be considered.

Note: The grille must be installed prior to inserting the unit into the sleeve.

1. Attach the 2 seal pieces (1" X 3/8" X 14") as shown in Fig. 1.
 2. Position the grille over the rear of the unit making sure that:
 - a. The double set of screw holes are at the bottom.
 - b. The fins of the grill are pointed away from the unit.
 3. Align the top of the grille with the top of the unit. The overhang on each side is equal.
 4. If the unit has not been pre-drilled (some models), carefully drill 4-1/8" holes through the grille and into the side flange of the unit approximately 1 1/2" to 2" from the top and bottom as in Fig. 2, 3.
- (Be careful not to drill into the copper heat exchanger coils.)
5. Install 4 - #8 self tapping screws to affix the grille to the unit.
 6. Insert the unit into the sleeve.

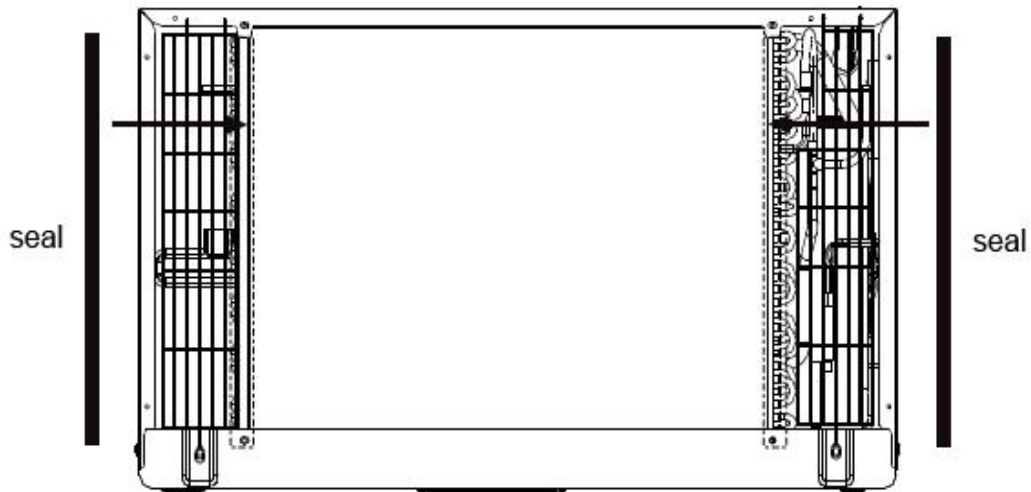

Fig. 1



Fig. 2

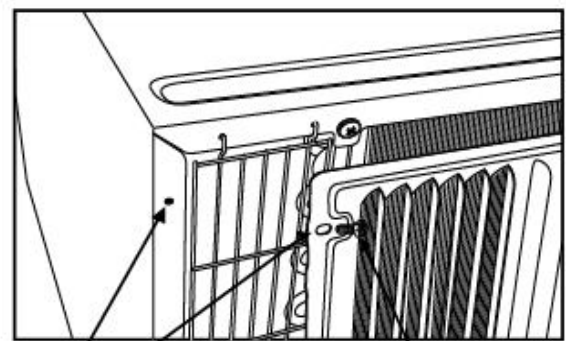

Fig. 3

1/8 Hole
Grille &
Flange

8 Screw

INSTALLATION INSTRUCTIONS

FINISHING INSTALLATION:



1. Install the 1"x1½"x84" long stuffer-seal between the wall-sleeve and the unit. A flat-bladed screwdriver or putty knife is recommended.



2. Assemble the trim frame by inserting top and bottom pieces into side pieces and snapping into place.

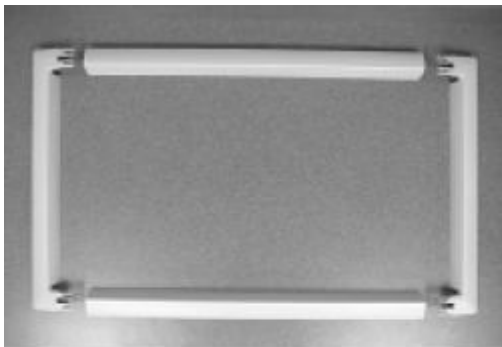

3. Pull cord through trim frame then slide over unit until flush with wall.