

REMOTE CONTROLLER

OWNER'S MANUAL

IMPORTANT NOTE:

Thank you for purchasing our air conditioner. Please read this manual carefully before operating your new air conditioning unit. Make sure to save this manual for future reference.

Table of Contents

Remote Controller Specifications	02
Handling the Remote Controller	03
Buttons and Functions	04
Remote Screen Indicators	08
How to Use Basic Functions	09
How to Use Advanced Functions	11

Remote Controller Specifications

Model	RG51F/EF, RG51F2(1)/EFU1, RG51F4/E, RG51F5(1)/EU1, RG51H(1)/EF, RG51H1(1)/EF, RG51H2(1)/EFU1-M, RG51H3(1)/EU1-M
Rated Voltage	3.0V(Dry batteries R03/LR03×2)
Signal Receiving Range	8m
Environment	-5°C~60°C(23°F~140°F)

Quick Start Guide

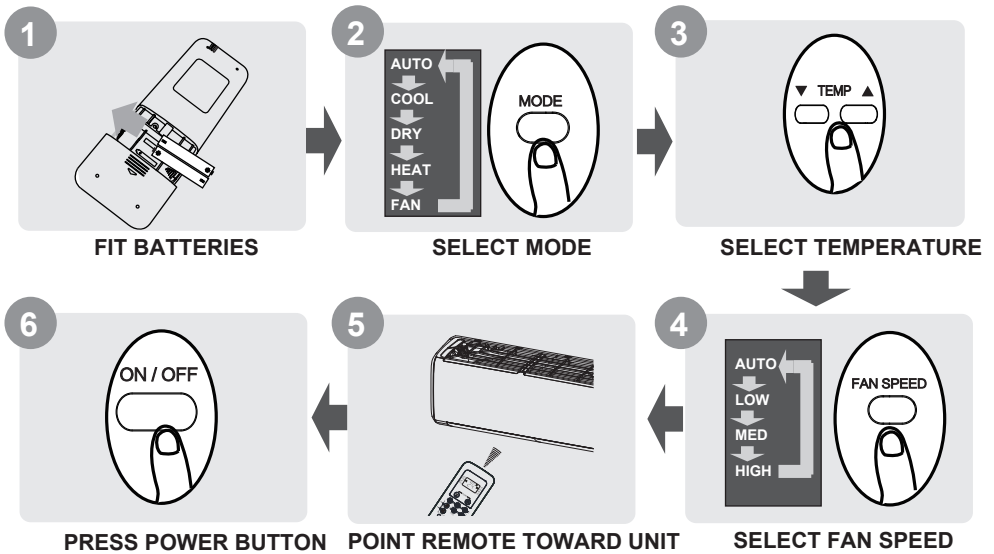

NOT SURE WHAT A FUNCTION DOES?

Refer to the **How to Use Basic Functions** and **How to Use Advanced Functions** sections of this manual for a detailed description of how to use your air conditioner.

SPECIAL NOTE

- Button designs on your unit may differ slightly from the example shown.
- If the indoor unit does not have a particular function, pressing that function's button on the remote control will have no effect.
- When there are wide differences between "Remote controller Manual" and "USER'S MANUAL" on function description, the description of "USER'S MANUAL" shall prevail.

Handling the Remote Controller

Inserting and Replacing Batteries

Your air conditioning unit may come with two batteries(some units). Put the batteries in the remote control before use.

1. Slide the back cover from the remote control downward, exposing the battery compartment.
2. Insert the batteries, paying attention to match up the (+) and (-) ends of the batteries with the symbols inside the battery compartment.
3. Slide the battery cover back into place.

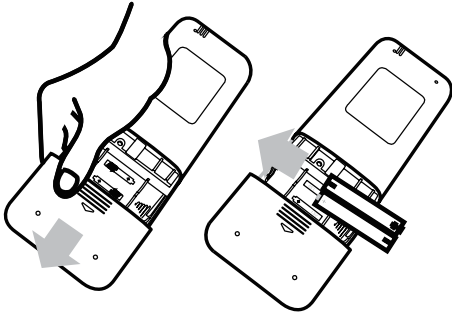

! BATTERY NOTES

For optimum product performance:

- Do not mix old and new batteries, or batteries of different types.
- Do not leave batteries in the remote control if you don't plan on using the device for more than 2 months.



BATTERY DISPOSAL

Do not dispose of batteries as unsorted municipal waste. Refer to local laws for proper disposal of batteries.

TIPS FOR USING REMOTE CONTROL

- The remote control must be used within 8 meters of the unit.
- The unit will beep when remote signal is received.
- Curtains, other materials and direct sunlight can interfere with the infrared signal receiver.
- Remove batteries if the remote will not be used more than 2 months.

CAUTIONS FOR USING REMOTE CONTROL

The device could comply with the local national regulations.

- In Canada, it should comply with CAN ICES-3(B)/NMB-3(B).
- In USA, this device complies with part 15 of the FCC Rules. Operation is subject to the following two conditions:
 - (1) This device may not cause harmful interference, and
 - (2) this device must accept any interference received, including interference that may cause undesired operation.

This equipment has been tested and found to comply with the limits for a Class B digital device, pursuant to part 15 of the FCC Rules. These limits are designed to provide reasonable protection against harmful interference in a residential installation. This equipment generates, uses and can radiate radio frequency energy and, if not installed and used in accordance with the instructions, may cause harmful interference to radio communications. However, there is no guarantee that interference will not occur in a particular installation. If this equipment does cause harmful interference to radio or television reception, which can be determined by turning the equipment off and on, the user is encouraged to try to correct the interference by one or more of the following measures:

- Reorient or relocate the receiving antenna.
- Increase the separation between the equipment and receiver.
- Connect the equipment into an outlet on a circuit different from that to which the receiver is connected.
- Consult the dealer or an experienced radio/TV technician for help.
- Changes or modifications not expressly approved by the party responsible for compliance could void user's authority to operate the equipment.

Buttons and Functions

Before you begin using your new air conditioner, make sure to familiarize yourself with its remote control. The following is a brief introduction to the remote control itself. For instructions on how to operate your air conditioner, refer to the **How to Use Basic Functions** section of this manual.

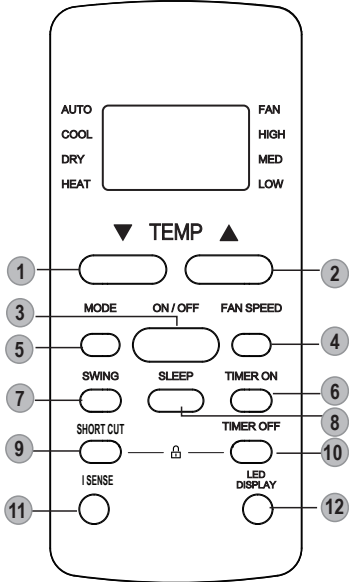

Model: R51F/EF

- 1 **TEMP ▼** : Decreases temperature in 1°C increments. Min. temperature is 17°C.
- 2 **TEMP ▲** : Increases temperature in 1°C increments. Max. temperature is 30°C.
- 3 **ON/OFF**: Turns the unit on or off.
- 4 **FAN SPEED**: Selects fan speeds in the following order: **AUTO → LOW → MED → HIGH**
- 5 **MODE**: Scrolls through operation modes as follows: **AUTO → COOL → DRY → HEAT → FAN**
NOTE: Please do not select HEAT mode if the machine you purchased is cooling only type. Heat mode is not supported by the cooling only appliance.
- 6 **TIMER ON**: Sets timer to turn unit on (see **How to Use Basic Functions** for instructions).
- 7 **SWING**: Starts and stops the horizontal louver movement. Hold down for 2 seconds to initiate vertical louver auto swing feature (some units).

- 8 **SLEEP**: Saves energy during sleeping hours.
- 9 **SHORT CUT**: Sets and activates your favorite pre-settings
- 10 **TIMER OFF**: Sets timer to turn unit off (see **How to Use Basic Functions** for instructions).
- 11 **I SENSE**: Temperature sensing and room temperature display button.
- 12 **LED DISPLAY**: Press this button to turn on and turn off the display on the indoor unit.
NOTE: Press together the two buttons simultaneously for 5 seconds to lock the keyboard. Press together the two buttons for 2 seconds to unlock the keyboard.

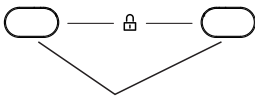

Press together simultaneously

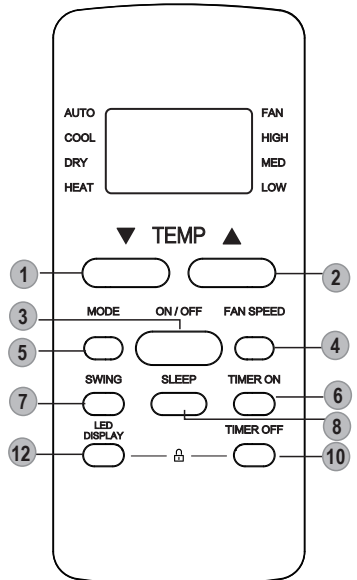

Model: R51F4/E

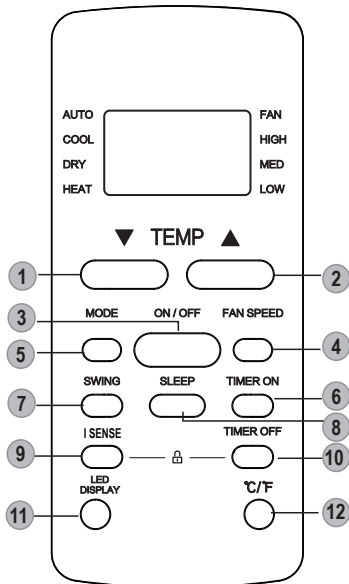

Model: R51F2(1)/EFU1

- 1 **TEMP ▼** : Decreases temperature in 1°F increments. Min. temperature is 62°F.
- 2 **TEMP ▲** : Increases temperature in 1°F increments. Max. temperature is 86°F.
- 3 **ON/OFF**: Turns the unit on or off.
- 4 **FAN SPEED**: Selects fan speeds in the following order: **AUTO → LOW → MED → HIGH**
- 5 **MODE**: Scrolls through operation modes as follows: **AUTO → COOL → DRY → HEAT → FAN**
NOTE: Please do not select HEAT mode if the machine you purchased is cooling only type. Heat mode is not supported by the cooling only appliance.
- 6 **TIMER ON**: Sets timer to turn unit on (see **How to Use Basic Functions** for instructions).
- 7 **SWING**: Starts and stops the horizontal louver movement. Hold down for 2 seconds to initiate vertical louver auto swing feature (some units).

- 8 **SLEEP**: Saves energy during sleeping hours.
- 9 **I SENSE**: Temperature sensing and room temperature display button.
SHORT CUT: Sets and activates your favorite pre-settings.
- 10 **TIMER OFF**: Sets timer to turn unit off (see **How to Use Basic Functions** for instructions).
- 11 **LED DISPLAY**: Press this button to turn on and turn off the display on the indoor unit.
- 12 **°C/°F**: Press this button to alternate the temperature display between the °C & °F.

NOTE: Press together the two buttons simultaneously for 5 seconds to lock the keyboard. Press together the two buttons for 2 seconds to unlock the keyboard.

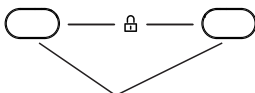

Press together simultaneously

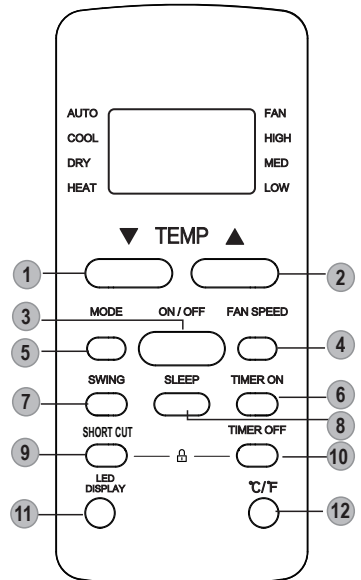

Model: R51F5(1)/EU1

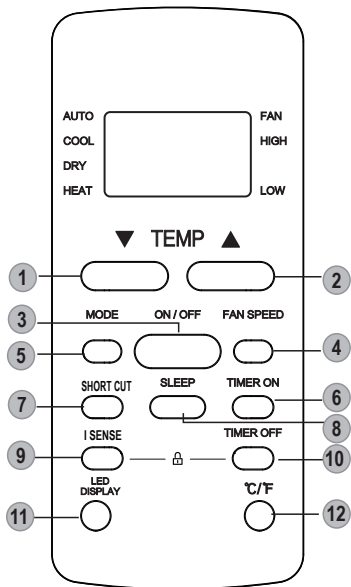

Model: R51H2(1)/EFU1-M

- 1 **TEMP ▼** : Decreases temperature in 1°F increments. Min. temperature is 62°F.
- 2 **TEMP ▲** : Increases temperature in 1°F increments. Max. temperature is 86°F.
- 3 **ON/OFF**: Turns the unit on or off.
- 4 **FAN SPEED**: Selects fan speeds in the following order: **AUTO**→ **LOW** → **HIGH**
- 5 **MODE**: Scrolls through operation modes as follows: **AUTO** → **COOL** → **DRY**→ **HEAT** → **FAN**
NOTE: Please do not select HEAT mode if the machine you purchased is cooling only type. Heat mode is not supported by the cooling only appliance.
- 6 **TIMER ON**: Sets timer to turn unit on (see **How to Use Basic Functions** for instructions).
- 7 **SHORT CUT**: Sets and activates your favorite pre-settings.

- 8 **SLEEP**: Saves energy during sleeping hours .
- 9 **I SENSE**: Temperature sensing and room temperature display button.
- 10 **TIMER OFF**: Sets timer to turn unit off (see **How to Use Basic Functions** for instructions).
- 11 **LED DISPLAY**: Press this button to turn on and turn off the display on the indoor unit.
- 12 **°C/°F**: Press this button to alternate the temperature display between the °C & °F.

NOTE: Press together the two buttons simultaneously for 5 seconds to lock the keyboard. Press together the two buttons for 2 seconds to unlock the keyboard.

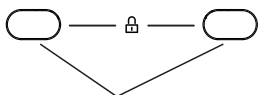

Press together simultaneously

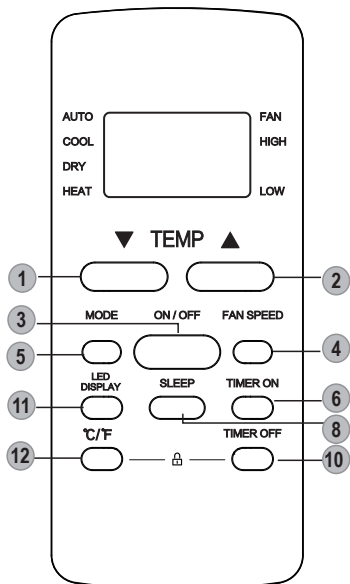

Model: R51H3(1)/EU1-M

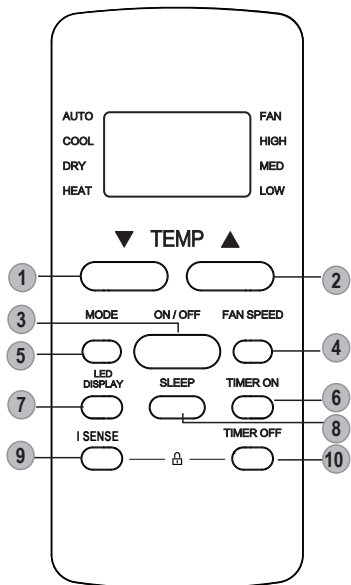

Model: R51H(1)/EF

- 1 **TEMP ▼** : Decreases temperature in 1°C increments. Min. temperature is 17°C.
- 2 **TEMP ▲** : Increases temperature in 1°C increments. Max. temperature is 30°C.
NOTE: Press together ▼ & ▲ buttons at the same time for 3 seconds will alternate the temperature display between the °C & °F.
- 3 **ON/OFF:** Turns the unit on or off.
- 4 **FAN SPEED:** Selects fan speeds in the following order: **AUTO → LOW → MED → HIGH**
- 5 **MODE:** Scrolls through operation modes as follows: **AUTO → COOL → DRY → HEAT → FAN**
NOTE: Please do not select HEAT mode if the machine you purchased is cooling only type. Heat mode is not supported by the cooling only appliance.
- 6 **TIMER ON:** Sets timer to turn unit on (see **How to Use Basic Functions** for instructions).
- 7 **LED DISPLAY:** Press this button to turn on and turn off the display on the indoor unit.

- 8 **SLEEP:** Saves energy during sleeping hours .
- 9 **I SENSE:** Temperature sensing and room temperature display button.
- 10 **TIMER OFF:** Sets timer to turn unit off (see **How to Use Basic Functions** for instructions).
- 11 **SWING:** Starts and stops the horizontal louver movement. Hold down for 2 seconds to initiate vertical louver auto swing feature(some units) .
- 12 **FRESH:** Starts and stops the Fresh feature. It will help to purify the air in the room.

NOTE: Press together the two buttons simultaneously for 5 seconds to lock the keyboard. Press together the two buttons for 2 seconds to unlock the keyboard.

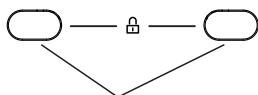

Press together simultaneously

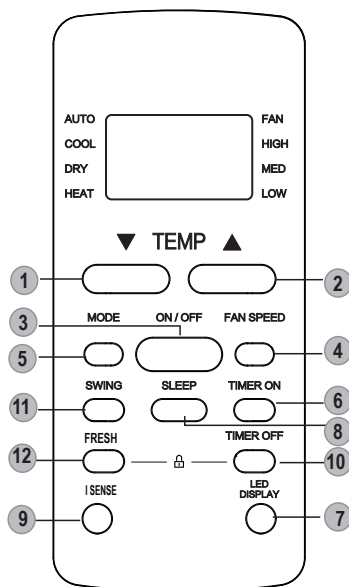

Model: R51H1(1)/EF





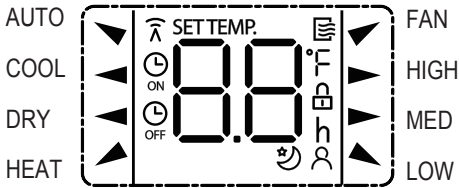



Remote Screen Indicators

Information are displayed when the remote controller is power up.



Mode display

AUTO ▼ COOL ◀ DRY ◀
HEAT ▲ ▼ FAN

-
-  Displayed when data transmitted.
 -  Displayed when remote controller is ON.
-
-  Displayed when TIMER ON time is set
 -  Displayed when TIMER OFF time is set
 -  Shows set temperature or room temperature, or time under TIMER setting
 -  Indicated all the current settings are locked
 -  Displayed when I SENSE feature is activated(some units)
 -  Displayed when SLEEP feature is activated

Fan speed indication

- ▶ HIGH High speed
- ▶ MED Medium speed(some units)
- ▲ LOW Low speed
- NO display Auto fan speed

Note:

All indicators shown in the figure are for the purpose of clear presentation. But during the actual operation, only the relative function signs are shown on the display window.

How to Use Basic Functions

! ATTENTION Before operation, please ensure the unit is plugged in and power is available.

AUTO Mode

Select AUTO mode



Set your desired temperature



Turn on the air conditioner



NOTE:

1. In AUTO mode, the unit will automatically select the COOL, FAN, or HEAT function based on the set temperature.
2. In AUTO mode, fan speed can not be set.

COOL or HEAT Mode

Select COOL/HEAT mode



Set the temperature



Set the fan speed



Turn on the air conditioner



DRY Mode

Select DRY mode



Set your desired temperature



Turn on the air conditioner



NOTE: In DRY mode, fan speed can not be set since it has already been automatically controlled.

FAN Mode

Select FAN mode



Set the fan speed



Turn on the air conditioner



NOTE: In FAN mode, you can't set the temperature. As a result, no temperature displays in remote screen.

Setting the TIMER

TIMER ON/OFF - Set the amount of time after which the unit will automatically turn on/off.

TIMER ON setting

Press **TIMER ON** button to initiate the ON time sequence.



Press **Temp. up or down** button for multiple times to set the desired time to turn on the unit.

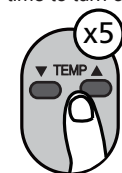

Point remote to unit and wait 1sec, the **TIMER ON** will be activated.



TIMER OFF setting

Press **TIMER OFF** button to initiate the OFF time sequence.



Press **Temp. up or down** button for multiple times to set the desired time to turn off the unit.

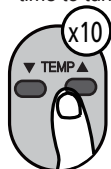

Point remote to unit and wait 1sec, the **TIMER OFF** will be activated.



NOTE:

- When setting the **TIMER ON** or **TIMER OFF**, the time will increase by 30 minutes increments with each press, up to 10 hours. After 10 hours and up to 24, it will increase in 1 hour increments. (For example, press 5 times to get 2.5h, and press 10 times to get 5h.) The timer will revert to 0.0 after 24.
- Cancel either function by setting its timer to 0.0h.

TIMER ON & OFF setting(example)

Keep in mind that the time periods you set for both functions refer to hours after the current time.

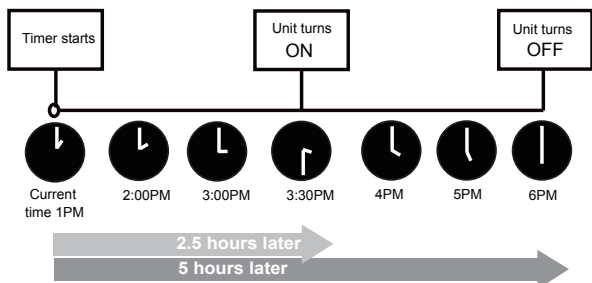
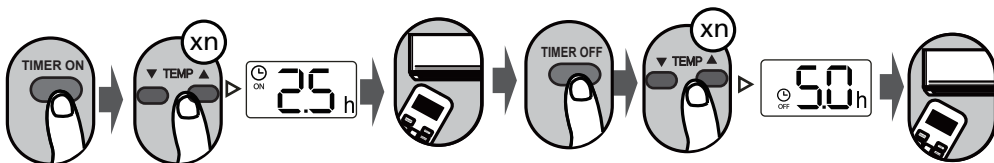

Example: If current timer is 1:00PM, to set the timer as above steps, the unit will turn on 2.5h later (3:30PM) and turn off at 6:00PM.

How to Use Advanced Functions

Swing function(some units)

Press Swing button

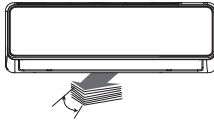

The horizontal louver will swing up and down automatically when pressing Swing button. Press again to make it stop.

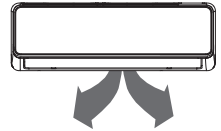

Keep pressing this button more than 2 seconds, the vertical louver swing function is activated. (Model dependent)

SLEEP function



The SLEEP function is used to decrease energy use while you sleep (and don't need the same temperature settings to stay comfortable). This function can only be activated via remote control. The sleep function is not available in Fan or Dry mode. Please refer to the OWNER'S MANUAL for more details.

I SENSE function(some units)



When the I SENSE function is activated, the remote display is actual temperature at its location. The remote control will send this signal to the air conditioner every 3 minutes interval until press the I SENSE button again.

NOTE: Press this button for seven seconds to start/stop memory feature of I SENSE function.

- If the memory feature is activated, "On" displays for 3 seconds on the screen.
- If the memory feature is stopped, "Off" displays for 3 seconds on the screen.
- While the memory feature is activated, press the ON/OFF button, shift the mode or power failure will not cancel the I SENSE function.

SHORTCUT function(some units)



Used to restore the current settings or resume previous settings.

Push this button when remote controller is on, the system will automatically revert back to the previous settings including operating mode, setting temperature, fan speed level and sleep feature(if activated).

If pushing more than 2 seconds, the system will automatically restore the current operation settings including operating mode, setting temperature, fan speed level and sleep feature (if activated).

FP function



The unit will operate at high fan speed (while compressor on) with temperature automatically set to 8°C/46°F.

Note: This function is for heat pump air conditioner only.

Press this button 2 times during one second under HEAT Mode and setting temperature of 17°C/62°F to activate FP function.

Press On/Off, Sleep, Mode, Fan and Temp. button while operating will cancel this function.

The design and specifications are subject to change without prior notice for product improvement. Consult with the sales agency or manufacturer for details.

CR2712-RG51F(H)(1)
16117000002421
2020.07.29

技术要求:

尺寸A5,大度
80克双胶纸
装订,黑白