

Keystone™

OWNER'S MANUAL

PORTABLE AIR CONDITIONER

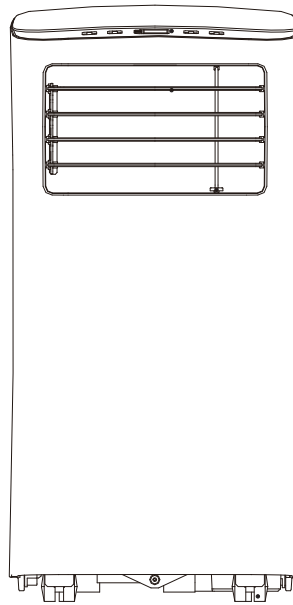

**KSTAP05PHA
KSTAP07PHA**

Thank you for purchasing our Portable Air Conditioner.
Read this owner's manual thoroughly before operating the appliance and keep it handy for reference at all times.



Tarjeta de Registracion de Producto

Es sencillo! Cumple y envia su Tarjeta de Registracion de Producto hoy!

Nombre _____

Dirección _____

Ciudad _____ Estado _____ Código postal _____

Teléfono (Opcional) _____ / _____ - _____

Dirección de E-mail (Opcional) _____

Donde Comprado _____

Numero de Modelo _____ Numero de Serie _____ Mes _____ Dia _____ Año _____

Fecha de la compra

REV 11/04

Porfavor devuelva su Tarjeta de Registracion de Producto hoy!



Product Registration Card

It's simple! Complete and mail your Product Registration Card today!

Name _____

Address _____

City _____ State _____ Zip _____

Phone (Optional) _____ / _____ - _____

E-mail Address (Optional) _____

Where Purchased _____

Model Number _____ Serial Number _____ Month _____ Day _____ Year _____

Date of Purchase

REV 11/04

Please return your Product Registration Card today!



KeystoneTM

PLACE
STAMP
HERE

Postage
Required:
Post Office will
not deliver
without proper
postage.

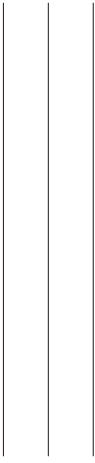
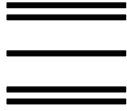

KeystoneTM

Product Warranty Card
Tarjeta de Garantia de Producto

Air conditioner warranty

Your product is protected by this warranty:
Your appliance is warranted by Keystone. Any obligations for services and parts under this warranty must be performed Keystone.

To contact a Customer Service Representative, Call TOLL FREE

800-849-1112

keystonecs@keystone-products.com

Garantia

Su producto está protegido por esta garantía:

Su producto está garantizado por Keystone. Cualquier obligación de proporcionar servicio o repuestos establecida en esta garantía deberá ser cumplida por los Servicios al consumidor de Keystone.

Para comunicarse con un Representante de Servicio al Cliente, tenga la bondad de llamar por teléfono sin cargo alguno a, al número:

800-849-1112

keystonecs@keystone-products.com

Preparation-----	2
Safety Precautions-----	3
Cautions -----	4
Installation-----	5
Operation -----	9
Maintenance -----	12
Troubleshooting Tips -----	13

Read This Manual

Inside you'll find many helpful hints on how to use and maintain your air conditioner properly. Just a little preventive care on your part can save you a great deal of time and money over the life of your air conditioner. You'll find many answers to common problems in the troubleshooting tips - you should be able to fix most of them quickly before calling service. These instructions may not cover every possible condition of use, so common sense and attention to safety is required when installing, operating, and maintaining this product.

Preparation

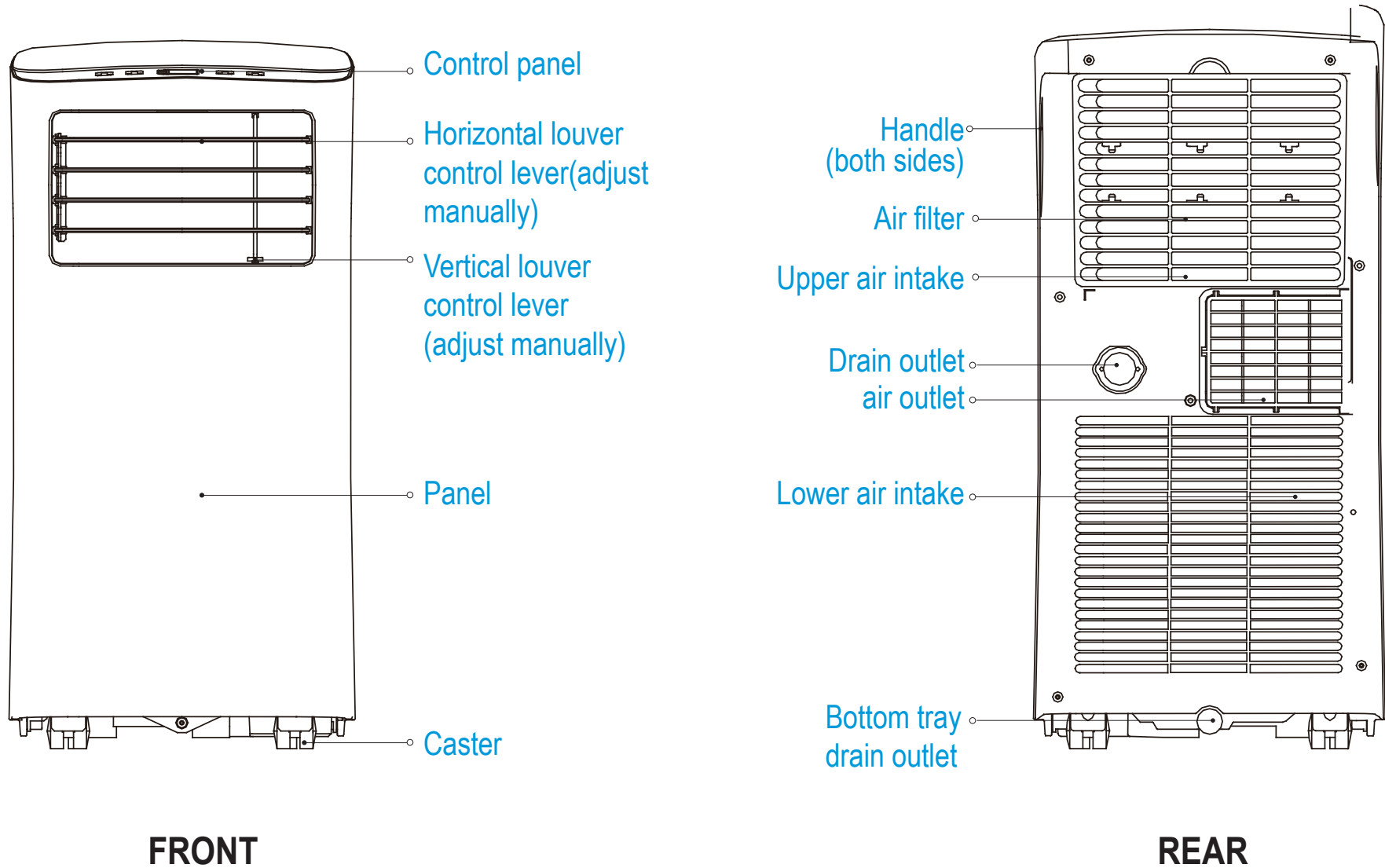

Design Notice: In order to ensure the optimal performance of our products, the design specifications of the unit and remote control are subject to change without prior notice.

| Safety Precautions

Please read through these instructions before you start the installation process. Improper installation can cause damage to the unit, your personal property, and also poses a personal safety hazard.

- Installation must be performed according to the installation instructions. Improper installation can cause water leakage, electrical shock, or fire.
- Use only the included accessories and parts, and specified tools for the installation. Using non-standard parts can cause water leakage, electrical shock, fire, and injury or property damage.
- Make sure that the outlet you are using is grounded and has the appropriate voltage. The power cord is equipped with a three-prong grounding plug to protect against shock. Voltage information can be found on the side of the unit, behind the grille.
- Install the unit on a flat, sturdy surface. Failure to do so could result in damage or excessive noise and vibration.
- The unit must be kept free from obstruction to ensure proper function and to mitigate safety hazards.
- DO NOT modify the length of the power cord or use an extension cord to power the unit.
- DO NOT share a single outlet with other electrical appliances. Improper power supply can cause fire or electrical shock.

- DO NOT install your air conditioner in a wet room such as a bathroom or laundry room. Too much exposure to water can cause electrical components to short circuit.
- DO NOT install the unit in a location that may be exposed to combustible gas, as this could cause a fire.
- The unit has wheels to facilitate movement. Make sure not to use the wheels on thick carpet or to roll over objects, as this could cause the unit to fall.
- DO NOT operate the unit that has been dropped or damaged.
- DO NOT allow children to play with the air conditioner. Children must be supervised around the unit at all times.
- If the air conditioner is knocked over during use, turn off the unit and unplug it from the main power supply immediately. Visually inspect the unit to ensure there is no damage. If you suspect the unit has been damaged, contact a technician or customer service for assistance.
- During a thunderstorm, the power must be cut off to avoid damage to the machine due to lightning.



Caution: Risk of fire/flammable materials
(Required for R32/R290 units only)

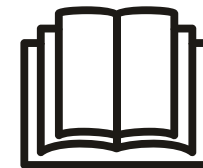

Caution: This symbol shows that the operation manual should be read carefully.

Cautions

- This appliance is not intended for use by persons (including children) with reduced physical, sensory or mental capabilities or lack of experience and knowledge, unless they have been given supervision or instruction concerning the use of the appliance by a person responsible for their safety.
- Children should be supervised to ensure that they do not play with the appliance.
- If the power cord is damaged, it must be replaced by the manufacturer, its service agent, or similarly qualified persons in order to avoid a hazard.
- Prior to cleaning or other maintenance, the appliance must be disconnected.
- Do not run cord under carpeting. Do not cover cord with throw rugs, runners, or similar coverings. Do not route cord under furniture or appliances. Arrange the cord away from the traffic area and where it will not be tripped over.
- Never attempt to operate this appliance if it is damaged, malfunctioning, partially disassembled, or has missing or broken parts, including a damaged cord or plug.
- To reduce the risk of fire or electric shock, do not use this unit with any solid-state speed control device.
- The appliance shall be installed in accordance with national wiring regulations.
- Contact the authorized service technician for repair or maintenance of this unit.
- Contact the authorized installer for the installation of this unit.
- When there are significant differences between features or operation implied by the remote control illustration and the actual functions described in the USER MANUAL, the descriptions in the USER MANUAL shall prevail.

Installation

Choosing The Right Location

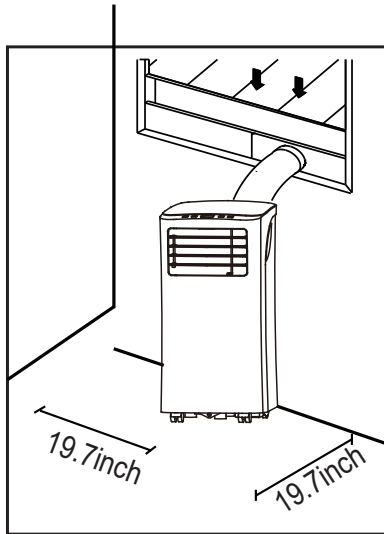

Recommend Installation

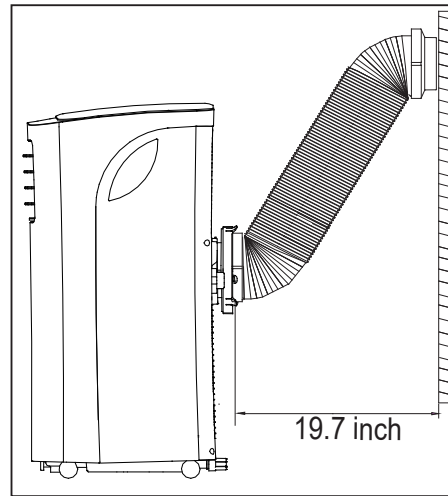

Your installation location should meet the following requirements:

- Make sure that you install your unit on an even surface to minimize noise and vibration.
- The unit must be installed near a grounded outlet, and the Collection Tray Drain (found on the back of the unit) must be accessible.
- The unit should be located at least 19.7 inches from the nearest wall to ensure proper air conditioning.
- DO NOT cover the Intakes, Outlets, or Remote Signal Receptor of the unit, as this could cause damage to the unit.

Note About Fluorinated Gasses

- This air-conditioning unit is a hermetically sealed unit that contains fluorinated gasses. For specific information on the type of gas and the amount, please refer to the relevant label on the unit itself.
- Service, maintenance, or repair of this unit must be performed by a certified technician.
- Product uninstallation and recycling must be performed by a certified technician according to local regulations.

NOTE:

All the illustrations in the manual are for explanation purposes only. Your air conditioner may be slightly different. The actual shape shall prevail.







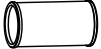

Installation

Tools Needed

- Medium Phillips screwdriver;
- Tape measure or ruler;
- Knife or scissors;
- Saw (optional, to shorten window adaptor for narrow windows)

Accessories

Your Window Installation Kit fits windows 26.5 – 48" and can be shortened for smaller windows.

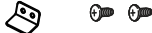
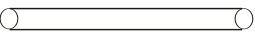
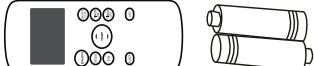
Part	Description	Quantity
	Unit Adaptor	1 pc
	Exhaust Hose	1 pc
	Window Slider Adaptor	1 pc
	Bolt	1 pc
	Window Slider A	1 pc
	Window Slider B	1 pc
	Foam Seal A (Adhesive)	2 pc
	Foam Seal B (Adhesive)	2 pc
	Foam Seal C (Non-adhesive)	1 pc
	Security Bracket and 2 Screws	1 set
	Drain Hose	1 pc
	Remote Control and Battery (For remote control models only)	1 set

Window Installation Kit

Step One: Preparing the exhaust hose assembly.

Press the exhaust hose into the window slider adaptor and the unit adaptor. Each adaptor will snap into the exhaust hose automatically with plastic clips.

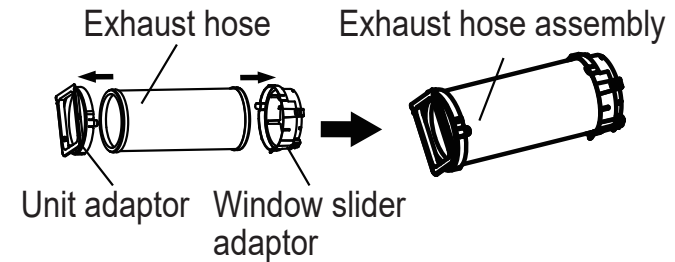

Step Two: Install the exhaust hose assembly to the unit

Align the unit adaptor of the exhaust hose assembly to the groove of the air outlet opening on the back of the unit. Slide the exhaust hose assembly along the direction indicated by the arrow for installation.

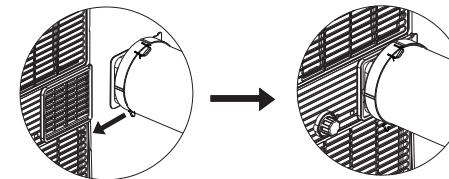

Step Three: Preparing the adjustable window slider

1. Depending on the size of your window, adjust the size of the window slider.
2. If the length of the window requires two window sliders, use the bolt to fasten the window sliders once they are adjusted to the proper length.

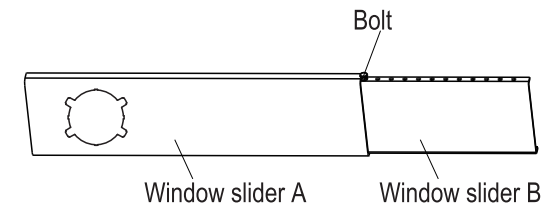

Installation

Note: Once the Exhaust Hose assembly and Adjustable Window Slider are prepared, choose from one of the following two installation methods.

Type 1: Hung Window Installation

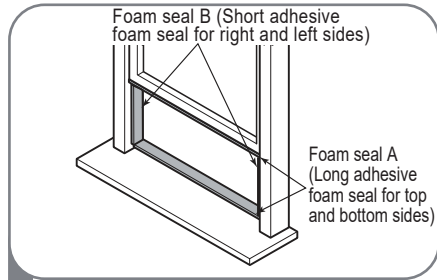

1 Cut the adhesive foam seal A and B strips to the proper lengths, and attach them to the window sash and frame as shown.

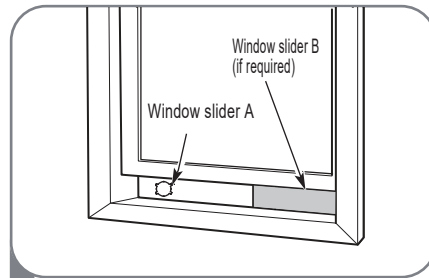

2 Insert the window slider assembly on the bottom sash channel. Use care when installing the window slider assembly, which will now fit very tightly in the opening. Close the sash tightly against the top of the window slider assembly.

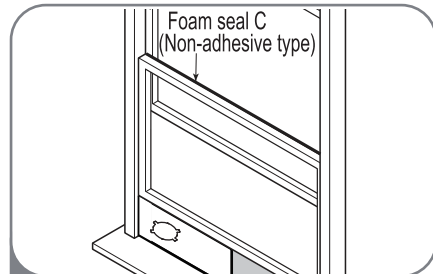

3 Cut the non-adhesive foam seal C strip to match the width of the window. Insert the seal between the glass and the window frame to prevent air and insects from getting into the room.

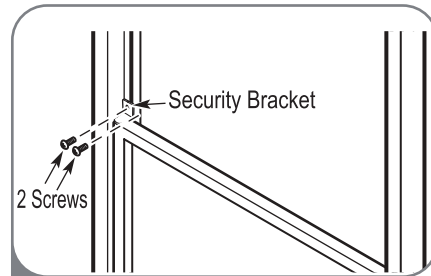

4 If desired, install the security bracket with 2 screws as shown.

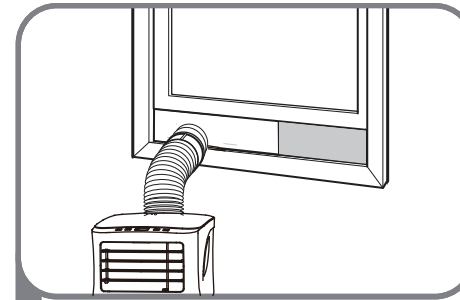

5 Insert the window slider adaptor into the hole of the window slider.

Type 2: Sliding Window Installation

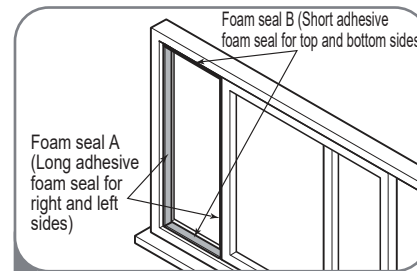

1 Cut the adhesive foam seal A and B strips to the proper lengths, and attach them to the window sash and frame as shown.

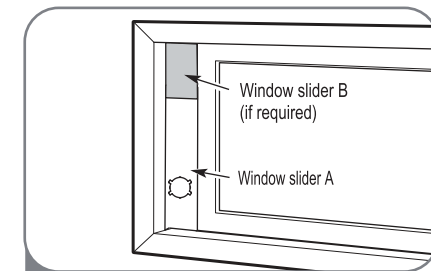

2 Insert the window slider assembly on the left or right sides of the sash channel. Use care when installing the window slider assembly, which will now fit very tightly in the opening. Close the sash tightly against the other side of the window slider assembly.

Installation

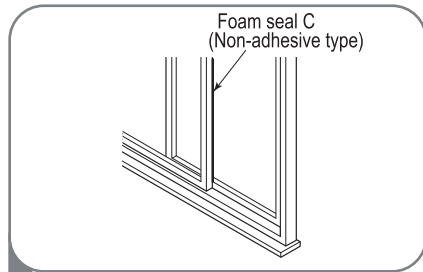

3 Cut the non-adhesive foam seal C strip to match the window height. Insert the foam seal between the glass and the window frame to prevent air and insects from getting into the room.

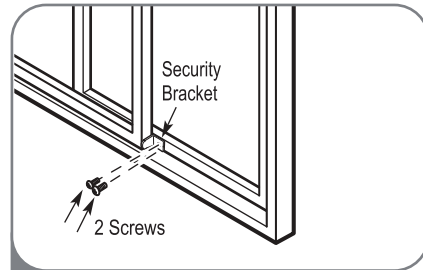

4 If desired, install the security bracket with 2 screws as shown.

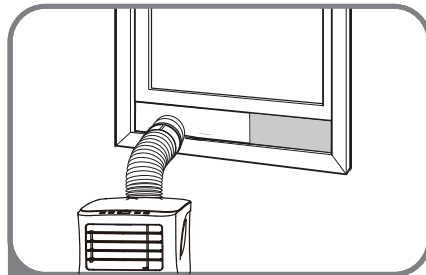

5 Insert the window slider adaptor into the hole of the window slider.

Note: To ensure proper function, DO NOT overextend or bend the hose. Make sure that there is no obstacle around the air outlet of the exhaust hose (in the range of 19.7 inches) in order for the exhaust system to work properly. All the illustrations in this manual are for explanation purposes only. Your air conditioner may be slightly different. The actual shape shall prevail.



Note: While operating in cool mode, the exhaust hose will become warm to the touch (This is normal). Having the exhaust hose overextended can cause radiant heat into the room causing ineffective operation.

Design and Compliance Notes

Design Notice

In order to ensure the optimal performance of our products, the design specifications of the unit and remote control are subject to change without prior notice.

Unit Temperature Range

Mode	Temperature Range
Cool	17-35°C (62-95°F)
Dry	13-35°C (55-95°F)

Operation

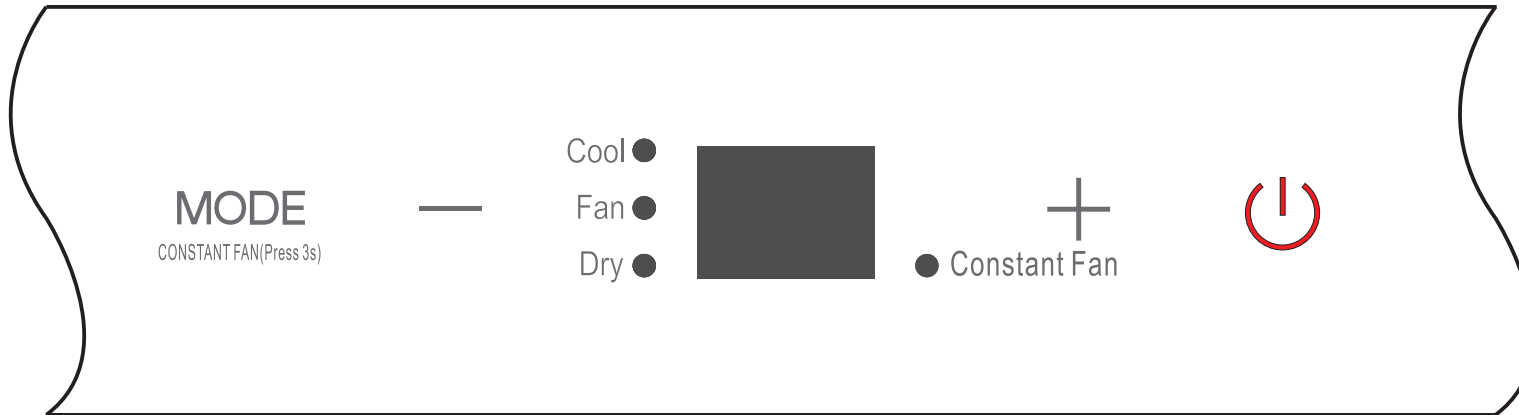

MODE MODE button

CONSTANT FAN(Press 3s)

Selects the desired operating mode. Each time you press the button, a mode is selected in a sequence that goes from COOL, FAN, and DRY. The mode light illuminates and indicates the selected mode.

- + Up (+) and Down (-) buttons

Used to adjust (increasing/decreasing) temperature settings in 1°C/1°F increments in a range of 17°C/62°F to 30°C/86°F.

NOTE: The control is capable of displaying temperature in degrees Fahrenheit or degrees Celsius. To convert from one to the other, press and hold the Up and Down buttons at the same time for 3 seconds.



Power button
Power switch on/off.

Operation

LED display

- Shows the set temperature in °C or °F and the Auto-timer settings. While on DRY and FAN modes, it shows the room temperature.
- Shows Error codes and protection code:
 - E1 - Room temperature sensor error.
 - E2 - Evaporator temperature sensor error.
 - E3 - Condenser temperature sensor error (on some models).
 - E4 - Display panel communication error.
 - E7 - Zero-crossing malfunction.
- P1 - Bottom tray is full--Connect the drain hose and drain the collected water away. If this error repeats, call for service.

Note: When one of the above malfunctions occurs, turn off the unit and check for any obstructions. Restart the Unit. If the malfunction persists, turn off the unit and unplug the power cord. Contact the manufacturer or its service agents or a similarly qualified person for service.



Operation Instructions

COOL operation

- Press the "MODE" button until the "COOL" indicator light comes on.
- Press the Up (+) and Down (-) buttons to select your desired room temperature. The temperature can be set within a range of 17°C~30°C/62°F~86°F.
- Press the "FAN" button to choose the fan speed.

DRY operation

- Press the "MODE" button until the "DRY" indicator light comes on.
- Under this mode, you cannot select a fan speed or adjust the temperature. The fan motor operates at LOW speed.
- Keep windows and doors closed for the best dehumidifying effect.
- Do not connect the exhaust hose to a window.

Self-Evaporation System

- In cool mode, this unit is made to self-evaporate. This means if you keep the rubber stoppers closed on the back of the unit, the water will evaporate and you will not have to drain.
- In cases of extreme humidity, you may have some water accumulation that the unit is unable to evaporate. In this case, the unit will beep 8 times, switch to fan mode,

and read P1 on the LED display (it will stay like this until the unit is drained). If this happens, you should drain the water from the lower drain (located at the bottom of the unit).

- The top drain is used only if you choose DRY mode.

* **Self Evaporation System works in COOL mode only**

AUTO operation

- This feature can be activated from the remote control ONLY.
- When you set the air conditioner in AUTO mode, it will automatically select cooling or fan only operation depending on what temperature you have selected and the current room temperature.
- The air conditioner will control room temperature automatically according to the temperature point set by you.
- Under AUTO mode, you cannot select the fan speed.

FAN operation

- Press the "MODE" button until the "FAN" indicator light comes on.
- Press the "FAN" button to choose the fan speed. The temperature cannot be adjusted.
- Do not connect the exhaust hose to a window.

Constant Fan operation

- In COOL or DRY mode, press the "MODE" button for 3 seconds to turn on or off the constant fan function. When the function is turned on, the constant fan light will illuminate, identifying that the fan will continuously run for cooling.

Operation

SLEEP/ECO operation

- This feature can be activated from the remote control ONLY. Activating SLEEP feature will increase the selected temperature by 1°C/1°F after 30 minutes. The temperature will again increase (cooling) by another 1°C/1°F after an additional 30 minutes. This new temperature will be maintained for 7 hours before returning to the originally selected temperature. This ends the Sleep/Eco mode and the unit will continue to operate as originally programmed.

NOTE: This feature is unavailable in FAN or DRY mode.

Other features

AUTO-RESTART

If the unit shuts off unexpectedly due to power outage, it will restart with the previous function setting automatically when the power resumes.

WAIT 3 MINUTES BEFORE RESUMING OPERATION

After the unit has stopped, it cannot be restarted until 3 minutes time has elapsed. This is to protect the unit. Operation will automatically start after 3 minutes.

AIR FLOW DIRECTION ADJUSTMENT

- The louver can be set to the desired position manually.
- Do not place any heavy objects or other loads on the louver, doing so will cause damage to the unit.
- Keep the louver fully opened during operation.

WATER DRAINAGE

- During dehumidifying modes, remove the drain plug from the back of the unit, install the drain connector (5/8" universal female mender) with a 3/4" hose (locally purchased). For the models without a drain connector, just attach the drain hose to the hole. Place the open end of the hose directly over the drain area in your basement floor.

NOTE: Make sure the hose is secure so there are no leaks. Direct the hose toward the drain, making sure that there are no kinks that will stop the water flowing. Place the end of the hose into the drain and make sure the end of the hose is down to let the water flow smoothly. When the continuous drain hose is not used, ensure that the drain plug and knob are installed firmly to prevent leakage.

- When the water level of the bottom tray reaches a predetermined level, the unit beeps 8 times, the digital display area shows "P1". At this time the air conditioning/dehumidification process will immediately stop. However, the fan motor will continue to operate (this is normal). Carefully move the unit to a drain location, remove the bottom drain plug and let the water drain away. Reinstall the bottom drain plug and restart the machine until the "P1" symbol disappears. If the error repeats, call for service.

NOTE: Be sure to reinstall the bottom drain plug firmly to prevent leakage before using the unit.

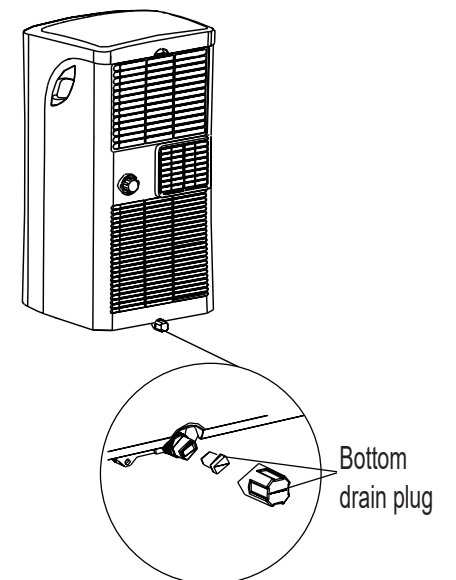
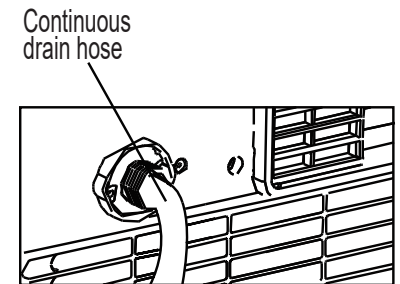
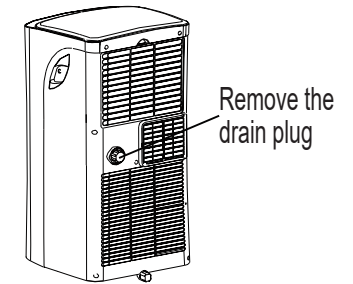

Maintenance

Safety Precautions

- Always unplug the unit before cleaning or servicing.
- DO NOT use flammable liquids or chemicals to clean the unit.
- DO NOT wash the unit under running water. Doing so causes electrical danger.
- DO NOT operate the machine if the power supply was damaged during cleaning. A damaged power cord must be replaced with a new cord from the manufacturer.

Clean the Air Filter

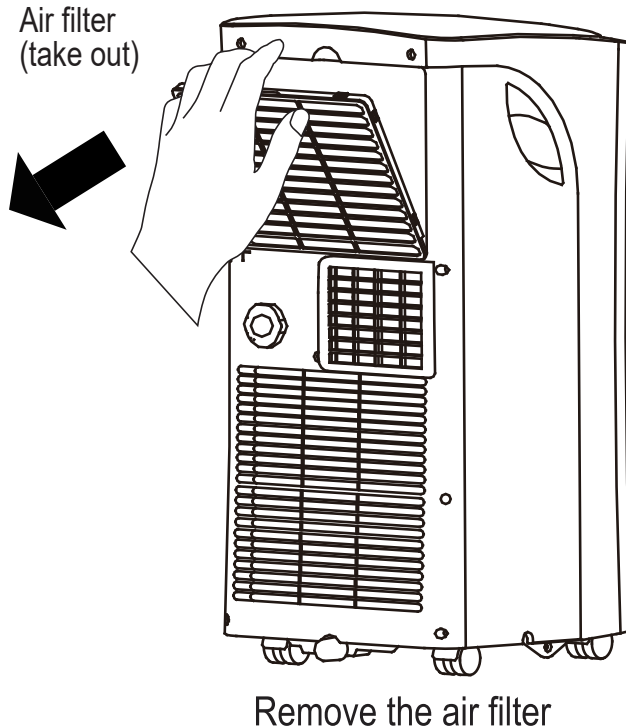

Maintenance Tips

- Be sure to clean the air filter every 2 weeks for optimal performance.
- The water collection tray should be drained immediately after P1 error occurs, and before storage to prevent mold.
- In households with animals, you will have to periodically wipe down the grille to prevent blocked airflow due to animal hair.

Clean the Unit

Clean the unit using a damp, lint-free cloth and mild detergent. Dry the unit with a dry, lint-free cloth.

Store the unit when not in use

- Drain the unit's water collection tray.
- Run the appliance on FAN mode for 12 hours in a warm room to dry it and prevent mold.
- Turn off the appliance and unplug it.
- Clean the air filter according to the instructions in the previous section. Reinstall the clean, dry filter before storing.
- Remove the batteries from the remote control.



Be sure to store the unit in a cool, dark place. Exposure to direct sunlight or extreme heat can shorten the lifespan of the unit.

Troubleshooting Tips

Before calling for service, review this list. It may save you time and expense. This list includes common problems that may not be the result of defective workmanship or materials in this appliance.

Problem	Possible Cause	Troubleshooting
Unit does not turn on when pressing ON/OFF button	P1 Error Code	The Water Collection Tray is full. Turn off the unit, drain the water from the Water Collection Tray, and restart the unit.
	In COOL mode: room temperature is lower than the set temperature	Reset the temperature
Unit does not cool well	The air filter is blocked with dust or animal hair	Turn off the unit and clean the filter according to instructions
	The exhaust hose is not connected or is blocked	Turn off the unit, disconnect the hose, check for blockage, and reconnect the hose
	The unit is low on refrigerant	Call a service technician to inspect the unit and top off refrigerant
	The temperature setting is too high	Decrease the set temperature
	The windows and doors in the room are open	Make sure all windows and doors are closed
	The room area is too large	Double-check the cooling area
	There are heat sources inside the room	Remove the heat sources if possible
The unit is noisy and vibrates too much	The floor is not level	Place the unit on a flat, level surface
	The air filter is blocked with dust or animal hair	Turn off the unit and clean the filter according to instructions
The unit makes a gurgling sound	This sound is caused by the flow of refrigerant inside the unit	This is normal

