

# DCi Series – Network Models

## Operation Manual



**DCi 8|600N**

**DCi 8|300N**

**DCi 4|600N**

**DCi 4|300N**

**DCi 2|600N**

**DCi 2|300N**

**DCi 4|1250N**

**DCi 2|1250N**

**DCi 4|2400N**

**DCi 2|2400N**

**Product Registration:** Register your new product at <http://warranty.harmanpro.com>.

**Obtaining Other Language Versions:** To obtain information in another language about the use of this product, please contact your local Crown Distributor. If you need assistance locating your local distributor, please contact Crown at 574-294-8000 or visit [www.crownaudio.com](http://www.crownaudio.com).

This manual does not include all of the details of design, production, or variations of the equipment. Nor does it cover every possible situation which may arise during installation, operation or maintenance.

The information provided in this manual was deemed accurate as of the publication date. However, updates to this information may have occurred. To obtain the latest version of this manual, please visit the Crown website at [www.crownaudio.com](http://www.crownaudio.com).

**Trademark Notice:** Com-Tech, BCA, Crown, Crown Audio, Amcron and Multi-Mode are registered trademarks of Crown International. DriveCore, DriveCore Install, IQwic, PIP and PIP2 are trademarks of Crown International. Other trademarks are the property of their respective owners.

**Some models may be exported under the name Amcron®**

# Important Safety Instructions

1. Read these instructions.
2. Keep these instructions.
3. Heed all warnings.
4. Follow all instructions.
5. Do not use this apparatus near water.
6. Clean only with a dry cloth.
7. Do not block any ventilation openings. Install in accordance with the manufacturer's instructions.
8. Do not install near any heat sources such as radiators, heat registers, stoves, or other apparatus that produce heat.
9. Do not defeat the safety purpose of the Grounding-type plug. A polarized plug has two blades with one wider than the other and should not be used with this product. A grounding-type plug has two blades and a third grounding prong and is the proper plug for this product. The wide blade or the third prong is provided for your safety. If the provided plug does not fit into your outlet, consult an electrician for replacement of the obsolete outlet.
10. Protect the power cord from being walked on or pinched, particularly at plugs, convenience receptacles, and the point where they exit from the apparatus.



11. Only use attachments/accessories specified by the manufacturer.
13. Unplug this apparatus during lightning storms or when unused for long periods of time.
14. Refer all servicing to qualified service personnel. Servicing is required when the apparatus has been damaged in any way, such as power-supply cord or plug is damaged, liquid has been spilled or objects have fallen into the apparatus, the apparatus has been exposed to rain or moisture, does not operate normally, or has been dropped.
15. Use the mains plug to disconnect the apparatus from the mains.
16. **WARNING: TO REDUCE THE RISK OF FIRE OR ELECTRIC SHOCK, DO NOT EXPOSE THIS APPARATUS TO RAIN OR MOISTURE.**



17. **DO NOT EXPOSE THIS EQUIPMENT TO DRIPPING OR SPLASHING AND ENSURE THAT NO OBJECTS FILLED WITH LIQUIDS, SUCH AS VASES, ARE PLACED ON THE EQUIPMENT.**

18. **THE MAINS PLUG OF THE POWER SUPPLY CORD SHALL REMAIN READILY OPERABLE.**



**TO PREVENT ELECTRIC SHOCK DO NOT REMOVE TOP COVER. NO USER SERVICEABLE PARTS INSIDE. REFER SERVICING TO QUALIFIED SERVICE PERSONNEL.**



**TO COMPLETELY DISCONNECT THIS EQUIPMENT FROM THE AC MAINS, DISCONNECT THE POWER SUPPLY CORD PLUG FROM THE AC RECEPTACLE. THE MAINS PLUG OF THE POWER SUPPLY CORD SHALL REMAIN READILY OPERABLE.**

## WATCH FOR THESE SYMBOLS:



The lightning bolt triangle is used to alert the user to the risk of electric shock.



The exclamation point triangle is used to alert the user to important operating or maintenance instructions.



## IMPORTANT



DriveCore Install Series amplifiers require Class 2 output wiring.

## MAGNETIC FIELD

**CAUTION!** Do not locate sensitive high-gain equipment such as preamplifiers or tape decks directly above or below the unit. Because this amplifier has a high power density, it has a strong magnetic field which can induce hum into unshielded devices that are located nearby. The field is strongest just above and below the unit.

If an equipment rack is used, we recommend locating the amplifier(s) in the bottom of the rack and the preamplifier or other sensitive equipment at the top.

## FCC COMPLIANCE NOTICE

This device complies with part 15 of the FCC rules. Operation is subject to the following two conditions: (1) This device may not cause harmful interference, and (2) this device must accept any interference received, including interference that may cause undesired operation.

**CAUTION:** Changes or modifications not expressly approved by the party responsible for compliance could void the user's authority to operate the equipment.

**NOTE:** This equipment has been tested and found to comply with the limits for a Class B digital device, pursuant to part 15 of the FCC Rules. These limits are designed to provide reasonable protection against harmful interference in a residential installation. This equipment generates, uses, and can radiate radio frequency energy and, if not installed and used in accordance with the instruction manual, may cause harmful interference to radio communications. However, there is no guarantee that interference will not occur in a particular installation. If this equipment does cause harmful interference to radio or television reception, which can be determined by turning the equipment off and on, the user is encouraged to try to correct the interference by one or more of the following measures:

- Reorient or relocate the receiving antenna.
- Increase the separation between the equipment and receiver.
- Connect the equipment into an outlet on a circuit different from that to which the receiver is connected.
- Consult the dealer or an experienced radio/TV technician for help.

## DECLARATION OF CONFORMITY

**Issued By:** HARMAN International  
 1718 W. Mishawaka Rd.  
 Elkhart, IN 46517 U.S.A.

**European Representative's Name and Address:**

HARMAN International  
 Cranborne Road Potters Bar,  
 EN6 3JN United Kingdom

**Equipment Type:** Installed Sound Power Amplifiers

**Family Name:** DCi

**Model Names:** DCi 2|300N, DCi 2|600N, DCi 2|1250N, DCi 4|300N, DCi 4|600N, DCi 4|1250N, DCi 8|300N, DCi 8|600N, DCi 2|2400N, DCi 4|2400N

**EMC Standards:**

**EN 55103-1:2009 +A1:2012** EMC Compatibility – Product Family Standard for Audio, Video, Audio-Visual and Entertainment Lighting Control Apparatus for Professional Use, Part 1: Emissions

**EN 55103-1:2009 +A1:2012** Magnetic Field Emissions – Annex A @ 10cm and 20cm

**EN 61000-3-2:2006 +A1:2008 +A2:2009** Limits for Harmonic Current Emissions (equipment input current less than or equal to 16A)

**EN 61000-3-3:2013** Limitation of Voltage Fluctuations and Flicker in Low-Voltage Supply systems Rated Current less than or equal to 16A

**EN 55022:2012** Limits and Methods of Measurement of Radio Disturbance Characteristics of ITE: Radiated, Class B Limits; Conducted, Class A

**EN 55103-2:2009** EMC Compatibility – Product Family Standard for Audio, Video, Audio-Visual and Entertainment Lighting Control Apparatus for Professional Use, Part 2: Immunity

**EN 61000-4-2:2009 Ed 9** Electrostatic Discharge Immunity (Environment E2-Criteria B, 4k V Contact, 8k V Air Discharge)

**EN 61000-4-3:2010 Ed 3.2** Radiated, Radio-Frequency, EMC Immunity (Environment E2, Criteria A)

**EN 61000-4-4:2012 Ed12** Electrical Fast Transient/Burst Immunity (Criteria B)

**EN 61000-4-5:2014** Surge Immunity (Criteria B)

**EN 61000-4-6:2009** Immunity to Conducted Disturbances Induced by Radio-Frequency Fields (Criteria A)

**EN 61000-4-11:2004** Voltage Dips, Short Interruptions and Voltage Variation

**Safety Standard:**

**EN60065:2002 +A12:2011, IEC 60065:2001 Ed 7 +A1:2005 +A2:2010** Safety Requirements – Audio, Video, and Similar Electronic Apparatus

**CAN/CSA 60065-03 incl. A1** Safety Requirements – Audio, Video, and Similar Electronic Apparatus

**UL Std No. 60065-2007** Safety Requirements – Audio, Video, and Similar Electronic Apparatus

I certify that the product identified above conforms to the requirements of the EMC Council Directive 2004/108/EC and the Low Voltage Directive 2006/95/EC.

Signed

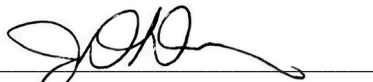

Jeff Denman  
 Sr. Director of Manufacturing

Date of Issue: March 26, 2015

# Table of Contents

Important Safety Instructions .....	2
Declaration of Conformity.....	3
Table of Contents.....	4
Welcome .....	5
Installation .....	6
Front & Back Panel Features.....	7
Hardware Setup and Configuration .....	9
Precautions.....	10
Software Setup .....	11
Netsetter .....	12
Offline/Online Operation.....	18
Set-up and System Configuration.....	20
General Purpose In/Out Control Port .....	27
Aux Port/Sleep/Amp Status .....	32
BLU link.....	33
Advanced Operation .....	37
Signal Path.....	48
Per Channel Settings.....	49
Protection System .....	50
Troubleshooting.....	51
DCi Specifications.....	53
AC Power Draw and Thermal Dissipation.....	56
Service .....	66
Warranty.....	68
Factory Service Information.....	69
Product Registration.....	71



# Welcome

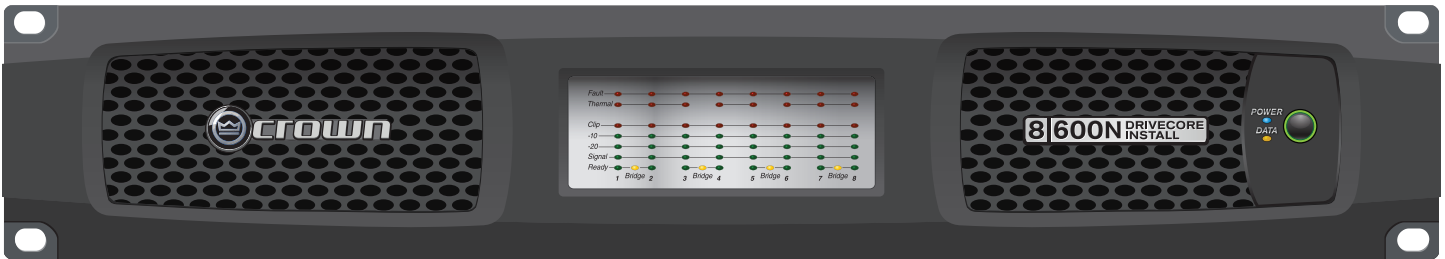

Thank you for purchasing a new Crown DriveCore™ Install Network Series installation amplifier, one in a complete line of high-performance amplifiers based on exclusive DriveCore technology. DriveCore Install Network Series amplifiers are designed, engineered and manufactured to the industry's highest quality standards, and provide system integrators with the advanced features and flexibility required for challenging 21st century installed sound applications. Versatile, compact and highly energy-efficient, DCi-N Series amplifiers continue the unbroken Crown tradition of leadership in professional and commercial power amplifier technology.

## Features

- Exclusive multi-patented DriveCore™ Technology – The patented DriveCore integrated circuit combines hundreds of discrete circuits into one chip for better performance, lower power consumption and improved reliability.
- BLU link Digital Audio Transport – Up to 256 Channels of digital audio over Category 5e– cabling.
- Configuration in HiQnet Audio Architect™
- Programmable General Purpose Input/Output Control Port
- Digital Signal Processing
  - Input/Output EQ Filters,
  - Crossover
  - Input/Output Delay
  - LevelMAX™ Limiters
- Priority Input Router
- PFC Power Supply–Universal PFC Power Supply for reduced current draw and provides industry leading efficiency.
- Monitoring and Control over TCP/IP.
- Real time Continuous Loading Monitoring.
- Power Saving Modes – Power consumption in sleep mode is less than 1W.
- Adjustable Auto Standby
- Remote Power Off – Sleep mode activated via AUX port.
- 70Vrms/100Vrms Direct Drive – Each channel individually selectable for low-Z or high-Z operation.
- Advanced Protection Circuits – Amplifier and loads are protected against shorted outputs, DC, mismatched loads, overheating, over- or under-voltage, and high frequency overload.
- Three Year, No-Fault Transferable Warranty – Your investment is fully protected.
- Complies with GreenEdge™ by HARMAN – Environmentally friendly practices in design, manufacturing, and packaging complement energy-efficient operation.

## How to Use This Manual

This manual provides you with the necessary information to safely and correctly setup and operate your Crown product. It does not cover every aspect of installation, setup or operation that might occur under every condition. For additional information, please contact technical support, your system installer or retailer.

We strongly recommend you read all instructions, warnings and cautions contained in this manual. Also, for your protection, please send in your warranty registration card today. And save your bill of sale — it's your official proof of purchase.

# Installation

## Unpacking

Unpack your amplifier and inspect for any damage that may have occurred during transit. If damage is found, notify the shipping company immediately. Only you can initiate a claim for shipping damage, though Crown will be happy to help as needed. If the product arrived showing signs of damage, save the shipping carton for the shipper's inspection.

We also recommend that you save all packing materials for use if you ever need to transport the unit. Never ship the unit without the factory carton and packing materials.

## Additional Materials

FOR INSTALLATION, YOU WILL NEED (not supplied):

- Input wiring cables
- Output wiring cables
- Flathead screwdriver
- Phillips screwdriver
- Rack for mounting amplifier (or a stable surface for stacking)
- Category 5e cabling



**WARNING:** Before you start to set up your amplifier, read and observe the Important Safety Instructions found at the beginning of this manual.

## Install the Amplifier



**CAUTION:** Before you begin, make sure your amplifier is disconnected from the power source and that all level controls (see Page 7) are set to ∞ knob Counterclockwise).

All DCi Series amplifiers are 3.5 in. (8.9 cm) high and 19 in. (48.3 cm) wide. All are 14.25 in. (36.2 cm) deep except the DCi8|600N & DCi4|1250N which are 17 in. (43.2 cm) deep, and the 2|2400N & 4|2400N which are 19 in. (48.3 cm) deep (See Figure 1)

Mount the unit in a standard 19-inch (48.3 cm) equipment rack (EIA RS-310B). You can also place a single amp on a solid, stable surface or stack multiple amps.

NOTE: Amplifiers should be supported at both the front and rear of the rack.

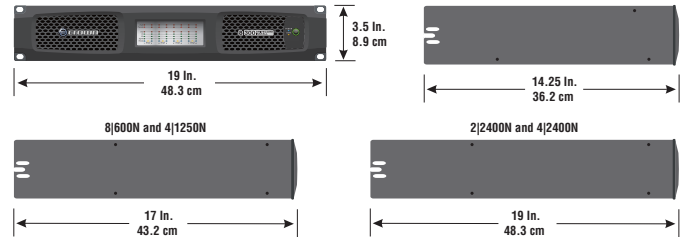

Figure 1

## Ensure Proper Cooling

When using an equipment rack, mount units directly on top of each other. Close any open spaces in the rack with blank panels. (Open spaces will reduce cooling efficiency.) DO NOT block front or rear air vents.

The rack should be a minimum of two inches (5.1 cm) away from the amplifier, and the back of the rack should be a minimum of four inches (10.2 cm) from the amplifier back panel.

Air flow is front to back as illustrated in Figure 2.

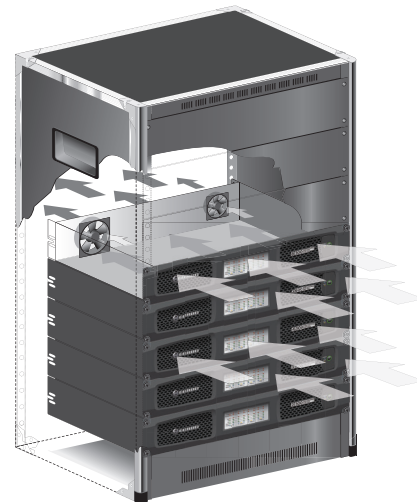

Figure 2

# Front Panel Features (All Models)

**Indicators:**

**Fault Indicator (red):** Flashes when the amplifier output channel has stopped operating. (See Page 50 Troubleshooting)

**Thermal Indicator (red):** Illuminates when the channel reaches 80 degrees Celsius, indicating the onset of protection compression. If the temperature continues to rise, the amplifier output will shut off at 98 degrees Celsius and remain off until a safe operating temperature is present.

**Clip Indicator (red):** Illuminates when any of the following conditions are present: Onset of audible clipping, clipped signal detected at input, clipped signal detected at output, engagement of protection circuits.

**Level and Signal Indicators (green):** Three LEDs indicate signal presence and level as follows: -10 = 10 dB below rated output -20 = 20 dB below rated output Signal = -40dBu input level

**Ready Indicator (green):** When this indicator is activated, the amplifier is ready to pass audio.

**Power Indicator (blue)**

Illuminates when the amplifier is ON and acceptable AC line voltage is present.

Blinks when AC line voltage is outside  $\pm 10\%$  range.

Flashes for 4 seconds if Power button pressed when amplifier is in sleep mode.

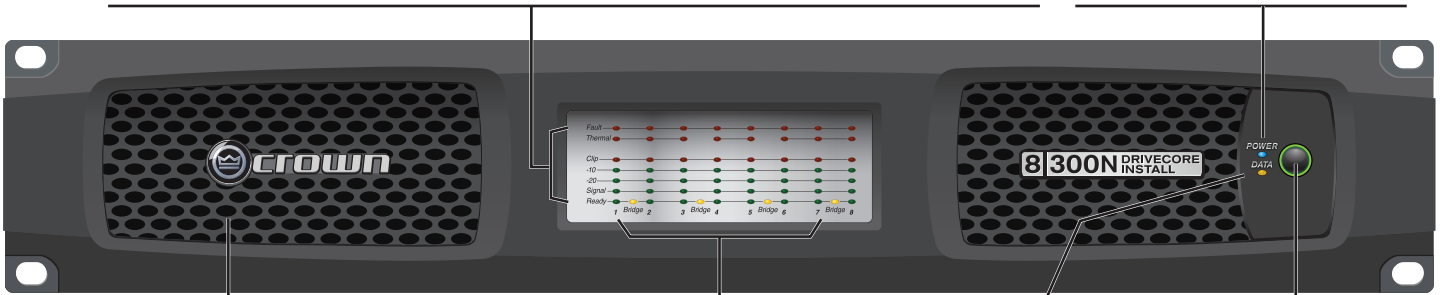

**Cooling Vent Grille**

Provides cooling air flow. Do not block or cover these vents.

**Bridge Mode Indicator (yellow)**

Illuminates when Bridge Mode is activated for the channel pair, only odd number channel will be active.

**Data Indicator (yellow)**

Illuminates when data present on the data network only. BLU link connectivity is not a part of this indicator.

**Power Button**

Power Ring Indicator (Green) - Illuminates when the amplifier is plugged into a wall outlet with acceptable power. NOTE: Power Button is disabled when AUX port Sleep circuit is used.

**Note:** Eight channel model shown. Indications per channel pair are identical for 2 and 4 channel models.

# Back Panel Features (2|300N, 2|600N, 2|1250N, 4|300N, 4|600N, 4|1250N, 8|300N, 8|600N)

**Power Fuse**

F20AH 250V, replace with same type fuse. Littelfuse 314 Series. DCi8|600N & 4|1250N incorporate the use of a resettable breaker instead of fuse.

**Ethernet\***

For monitoring and control of the amplifier over Category 5e wiring through the Audio Architect software.

**BLU link\***

**Input/Output Ring**  
Up to 256 channels of digital audio over Category 5e wiring. Only 60 nodes should be used in the BLU link Ring.

**Input Attenuators**

One 21-position detented potentiometer per channel. Logarithmic audio taper. Attenuation range mute to 0 dB.

**Input Connectors**

One 6-pin plug-in connector per input pair. High impedance balanced. (Refer to Page 9).

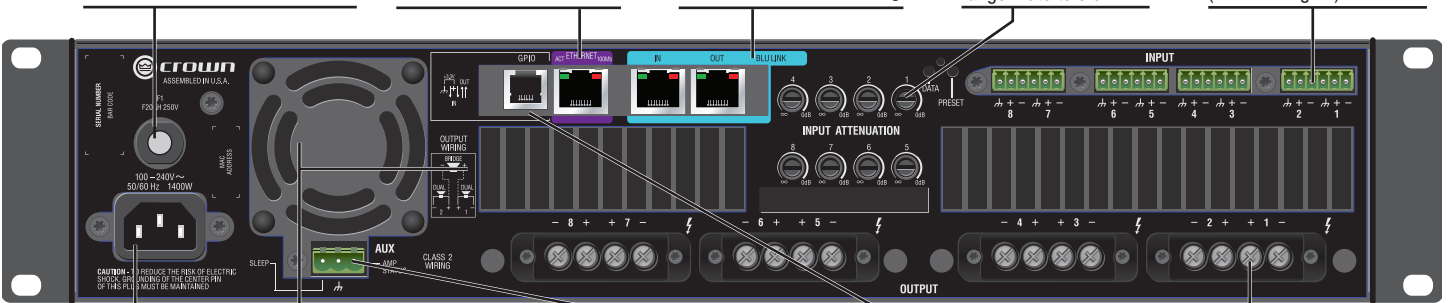

**AC Power Inlet**

Standard IEC type 320 inlet for detachable connector 100 - 240 V~. The DCi8|600N and 4|1250N use a 20A IEC connector.

**Cooling Fan Outlet**

Outlets for cooling air flow. Do not block or cover these outlets.

**Auxiliary Connector**

3-pin plug-in type connector, Enables SLEEP mode and monitoring of AMP STATUS unless the amplifier is in any of these conditions: OFF, SLEEP, or FAULT. (see Page 32)

**General Purpose Input/Output (GPIO)**

Connect to the amplifier via RJ-11. There are 2 analog input controls and 2 digital output controls.

**Output Connectors**

One four-pole touch-proof terminal strip per channel pair. Accepts up to 10 AWG wire or terminal forks.

**\*Warning:** Only connect to networks that remain inside the building

**Note:** This image reflects the DCi 8|300N back panel

# Back Panel Features (2|2400N, 4|2400N)

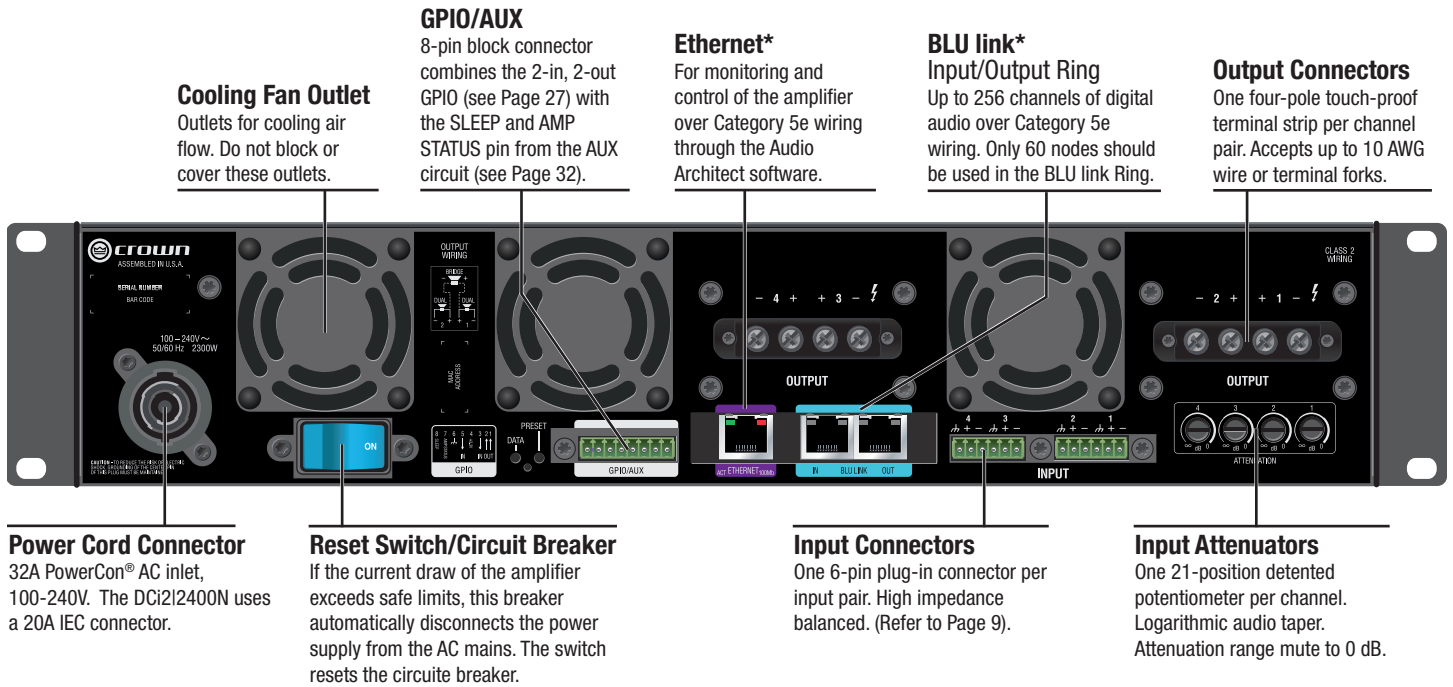

**\*Warning:** Only connect to networks that remain inside the building  
**Note:** This image reflects the DCi 4|2400N back panel

# Hardware Setup and Configuration

## Wire Input Connectors

Crown recommends using pre-built or professionally wired balanced cables (two-conductor plus shield). Balanced wiring provides better rejection of unwanted noise and hum; however, unbalanced line may also be used.

Use 6-pin plug-in cable ends at the amp input connectors. A male connector is supplied for each input of your model of amplifier. Additional connectors are available from Crown (P/N 5024623).

Figure 3 shows connector pin assignments for balanced wiring and Figure 4 shows connector pin assignments for unbalanced wiring. Note that for bridged operation, only the connectors for odd-numbered channels (1,3,5,7) for each bridged pair need be wired.

For BLU link audio connection, standard Category 5e cabling can be used. To increase fault tolerance of the BLU link audio ring, the input and the output should be connected to adjacent BLU link nodes. There is a maximum limit of 60 BLU link nodes for each audio ring.

Figure 3

### BALANCED LINE

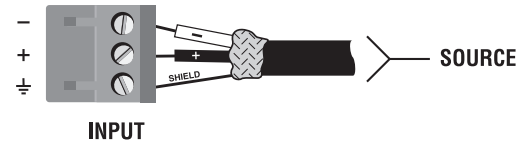

### UNBALANCED LINE

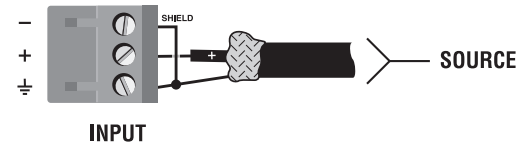

Figure 4

## Wire Output Connectors

Crown has designed an output cover that does not need to be removed to connect the output wiring.

Crown recommends using the included spade connectors and two- or four-conductor, heavy gauge speaker wire. You may use terminal forks up to 10 AWG or bare wire for your output connectors (see Figure 5). For best results, Crown recommends Panduit part #PV10-10LF-L or equivalent terminal fork. For bare wire, it is highly recommended that output wiring is tinned. To reduce strain on input and output wiring, Crown recommends the use of horizontal lacer bars. For best results, Crown recommends Middle Atlantic part# LBP-4R90 or equivalent horizontal lacer bar.

For low-impedance loads, select the appropriate size of wire based on the distance from amplifier to speaker.

Distance	Wire Size
Up to 25 ft. (7.6m)	16 AWG
26-40 ft. (7.9-12.2m)	14 AWG
41-60 ft. (12.5-18.3m)	12 AWG
> 60 ft (18.3m)	10 AWG

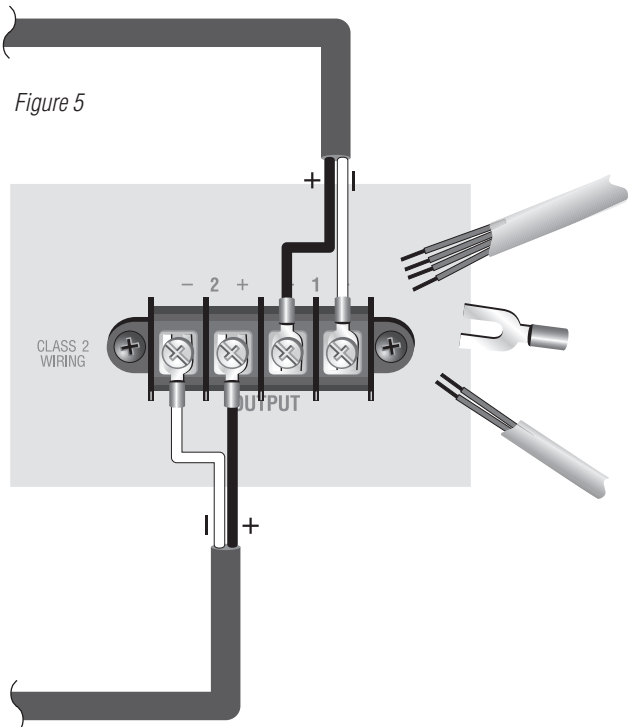

**CAUTION: Never use shielded cable for output wiring.**



**CAUTION: Never connect the speaker return to the chassis of the amplifier, or damage to the amplifier may result.**



**NOTE: Custom wiring should only be performed by qualified personnel. Class 2 output wiring is required.**

# Hardware Setup and Configuration

## Connect to AC Mains

Connect your amplifier to the AC mains power source (power outlet) using the supplied AC power cord set. First, connect the IEC end of the cord set to the IEC connector on the amplifier; then, plug the other end of the cord set to the AC mains.



**WARNING: The third prong of this connector (ground) is an important safety feature. Do not attempt to disable this ground connection by using an adapter or other methods.**

Make certain the AC mains voltage and current ratings are sufficient to deliver full power to all amplifiers. If the AC line voltage varies out of an acceptable range, the amplifier's power supply turns off and the blue Power LED flashes. The amplifier will turn back on when the AC line voltage returns to safe operating levels.

DriveCore Install Amplifiers utilize a universal power supply. The AC voltage requirements are 100VAC - 240VAC, 50/60Hz (+/-10%). If the voltage exceeds these requirements, then the Power LED will flash and the amplifier will stop passing audio until the voltage is within the requirements.

---

## Startup Procedure

When first turning on your amplifier:

1. Turn down the level of your audio source.
2. Turn down the input attenuators of the amplifier.
3. Turn on the "Power" switch. The Power indicator should light.
4. Turn up the level of your audio source to an optimum level. Ensure that at no point in the signal chain is the signal being clipped in any way.
5. Turn up the level controls on the amplifier to the desired loudness or power level.

**IMPORTANT:** Before making any wiring or installation changes, turn off the amplifier and disconnect the power cord.

For help with determining your system's optimum gain structure (signal levels) please refer to the Crown Amplifier Application Guide, available online at [www.crownaudio.com](http://www.crownaudio.com).

---

## Precautions

Your amplifier is protected from internal and external faults, but you should still take the following precautions for optimum performance and safety:

1. Configure the amplifier for proper operation, including input and output wiring hookup. Improper wiring can result in serious operating difficulties. For information on wiring and configuration, please consult Page 8 of this manual. For advanced setup techniques, consult Crown's Amplifier Application Guide available online at [www.crownaudio.com](http://www.crownaudio.com).
2. Use care when making connections, selecting signal sources and controlling the output level. The load you save may be your own!
  3. Do not short the ground lead of an output cable to the input signal ground. This may form a ground loop and cause oscillations.
-  **4. Never connect the output to a power supply, battery or power main. Electrical shock may result.**
  5. Tampering with the circuitry or making unauthorized circuit changes may be hazardous and invalidate all agency listings.
  6. Do not operate the amplifier with the RED Clip LEDs constantly flashing.
7. Do not overdrive the mixer, which will cause clipped signal to be sent to the amplifier. Such signals will be reproduced with extreme accuracy, and loudspeaker damage may result.
8. Do not operate the amplifier with less than the rated load impedance. Due to the amplifier's output protection, such a configuration may result in premature clipping and speaker damage.

Remember: Crown is not liable for damage that results from overdriving other system components.

# Software Setup

## Connect Loudspeakers and Configure for Loudspeaker Load

### Determine load impedances and power requirements

Before making any connections, carefully check and review the total impedance for loudspeaker systems to be connected to each amplifier output. If multiple loudspeakers are connected to one output (in series, parallel or series-parallel) for Low-Z operation, be certain the total system impedance is within allowed specification for the output. When multiple loudspeakers are connected to one output for Hi-Z operation, be certain total tapped power is below the rated power output for the channel.

**Note: Illustrations and some text references are for channel pair 1 - 2 only. Connections and settings are identical for channels 3 - 4 on four-channel models and for channels 5 - 6 and 7 - 8 on eight-channel models. Each channel may be configured independently on multichannel models.**

Set Up and Configuration of the DriveCore Install Network amplifiers can be completed through HiQnet Audio Architect™. The amplifier should be connected to a TCP/IP network via the Ethernet connection on the back of the amplifier. Note: the BLU link digital audio transport connectors cannot be used for control and monitoring of the amplifier.

To quickly configure your DriveCore Install Network amplifier, connect all of the amplifiers and configuration computer to the same network. For more information on network configuration, please visit <http://audioarchitect.harmanpro.com>. In the following example, we will only show amplifiers.

When Audio Architect is first loaded, the software will scan the network for HiQnet devices. All devices that are discovered on the network will be found under the ADD DEVICE tab on the left hand tree menu. If the devices are not found, then the network may not be configured correctly. See Figure 6.

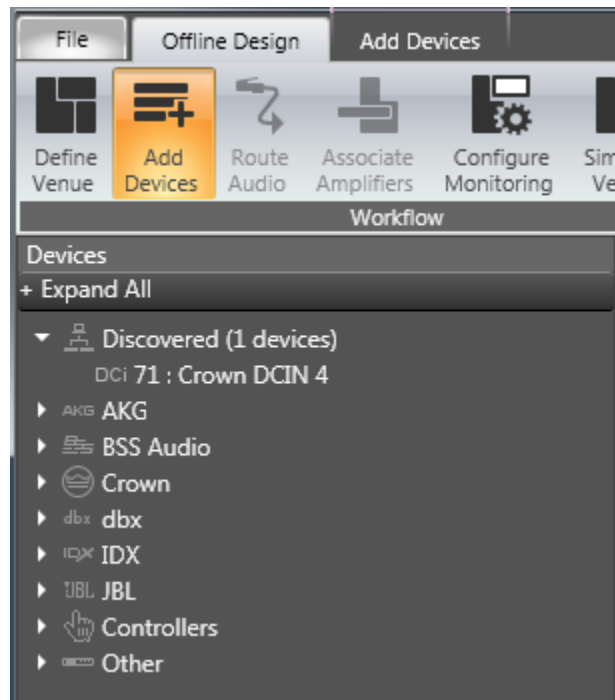

Figure 6



# NetSetter

## Introduction

The HiQnet NetSetter is a software tool which enables you to discover HiQnet devices and reconfigure network settings in real-time for each device. Its function is to configure a system of devices to interoperate correctly on the same network and resolve conflicts quickly and easily.

### NetSetter Window

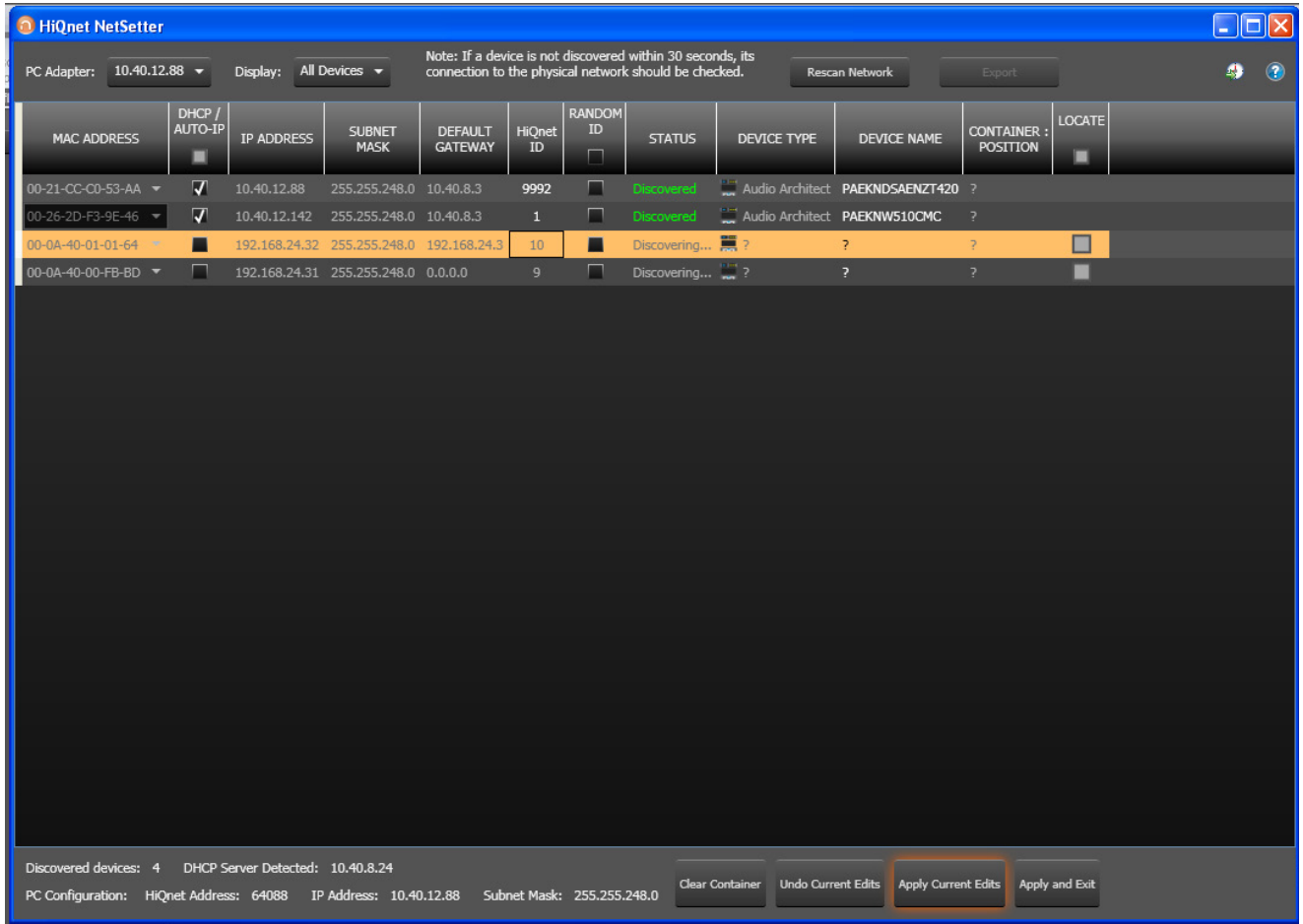

Figure 7

The top of the NetSetter page list overall operational functions that are available. They are as follows:

- **PC Adapter** – A drop list menu that selects the Network Interface Card (NIC)'s adapter that NetSetter will use to attempt to discover HiQnet devices. All available NIC's are listed by IP Address. Selecting a new NIC will force a rescan of the network to which the new NIC is connected.
- **Display** – This menu filters the device in the grid view by:
  - All Devices – Default setting. All discovered devices are displayed
  - HiQnet ID conflicts - Only discovered devices with HiQnet address conflicts are displayed.
  - IP address conflicts - Only discovered devices with IP address conflicts are displayed
  - All conflicts - Only discovered devices with either HiQnet address conflicts or IP address conflicts are displayed
  - Locked - Only devices in a Locked configuration.
  - Discovering-Only devices in the process of being discovered.
  - Discovered - Discovered devices with no conflicts.
  - DHCP / Auto IP - All devices which have been discovered with DHCP / Auto-IP enabled and those which have been set to use DHCP / Auto-IP on applying the edits
- **Rescan Network** – Clicking this button re-scans the network to which the currently selected NIC is connected.
- **Export** – The export button brings up a "Save As" window allowing you to save the HiQnet Addresses and IP Configurations of all devices on the network to a .CSV (Comma Separated Values) format. This allows you to archive the information and open it in a spreadsheet program such as Microsoft Excel.

At the bottom of the NetSetter window is an informational section that list the amount of discovered devices and the IP address of the DHCP Server. There is also information regarding the PC HiQnet Address, IP Address, and Subnet Mask. There are four buttons that perform the following functions:

- **Clear Container** - Resets the Container / Position Venue data of the selected device. The action occurs on either Apply Current Edits or Apply and Exit so that changes may be undone with the Undo Current Edits button.
- **Undo Current Edits** - Resets any open edits in the grid to the values as currently on the network.
- **Apply Current Edits** - Confirms any open edits in the grid. Devices update accordingly until connection is reestablished with HiQnet NetSetter
- **Apply and Exit** - Confirms and saves any open edits in the grid. The devices update accordingly until connection is reestablished with HiQnet.

Exit HiQnet NetSetter - If you have made changes to NetSetter, and attempt to exit the program the following window will pop up.

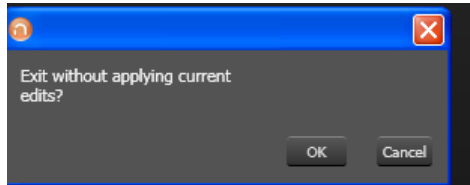

Figure 8

Clicking "OK" will apply the edits you have made since opening NetSetter.  
Clicking "Cancel" will return you to the program.

## The NetSetter Grid

The grid is divided into 12 sections:

- |                            |                          |
|----------------------------|--------------------------|
| 1. MAC Address             | 7. Random ID checkbox    |
| 2. DHCP / Auto-IP checkbox | 8. Status                |
| 3. IP Address              | 9. Device Type           |
| 4. Subnet Mask             | 10. Device Name          |
| 5. Default Gateway         | 11. Container : Position |
| 6. HiQnet ID               | 12. Locate               |

## MAC Address

Displays the MAC Address(es) of the discovered device.

If more than one MAC Address is discovered for a single device (HiQnet device MAC Address / AVB card MAC Address etc), the field is represented as a drop list. You may select between the connected MAC Addresses.

The data in this field cannot be edited.

- For a device connected to the same control network with two control MAC Addresses, the MAC Address field will be displayed in red.

## DHCP / Auto-IP

If the discovered device is set to use DHCP / Auto-IP, the check box will be checked. If the discovered device is not using DHCP / Auto-IP, you may check the box so it will do so on applying edits. The device row will then become selected. The device will attempt to have its IP settings configured by DHCP on applying the edits, if no DHCP server is present the device will attempt to have IP settings configured by Auto-IP.

All devices in the current filter view may be set to DHCP / Auto-IP on by checking the check box in the column header. The individual check boxes for all devices will be checked. If a single individual check boxes for all devices is subsequently unchecked the column header DHCP / Auto-IP checkbox will be automatically unchecked.

The devices in the current filter view may be set to DHCP / Auto-IP off by unchecking the check box in the column header.

DHCP server status will be among the information displayed at the bottom of the window. If a DHCP server is not detected, the information will read 'DHCP server not detected' Checking a device's DHCP / Auto-IP check box has no immediate effect on the column sort order.

Once edits have been made, it is critical to click the "Apply Current Edits" or "Apply and Exit" buttons.

## IP Address

Displays the IP address of the discovered device

A valid IP address may be edited inline. If the edited value scopes the device out of the current Display filter, it will not be visible.

### Devices discovered with a conflicting IP Address

A discovered device with an IP Address that conflicts with one that has already been discovered will be displayed in red. A conflicting IP Address may be edited inline if you wish to change the device IP Address on applying current edits.

### If DHCP / Auto-IP is enabled the IP address field may not be edited inline.

Once edits have been made, it is critical to click the "Apply Current Edits" or "Apply and Exit" buttons.

## Subnet Mask

Displays the Subnet Mask of the discovered device.

The Subnet Mask may be edited inline.

- The device row will be ordered accordingly with the current column sort immediately on successful editing of the field
- The device row will remain selected

### If DHCP / Auto-IP is enabled the Subnet Mask field may not be edited inline.

Once edits have been made, it is critical to click the "Apply Current Edits" or "Apply and Exit" buttons.

## Default Gateway

Displays the Default Gateway of discovered device

May be edited inline.

- The device row will be ordered accordingly with the current column sort immediately on successful editing of the field
- The device row will remain selected

### If DHCP / Auto-IP is enabled the Default Gateway field may not be edited inline

If the device is being rediscovered then:

- When the device is not selected, the device Default Gateway address field is displayed but is grayed out, represented in light gray.
- When the device is selected and highlighted in orange the field is represented in dark gray.

Once edits have been made, it is critical to click the "Apply Current Edits" or "Apply and Exit" buttons.

## HiQnet ID

Displays the HiQnet address of the discovered device.

May be edited inline if you want to change the device HiQnet address.

If the edited value scopes the device out of the current Display filter, it will not be visible. No devices will be selected

If devices discovered with a conflicting HiQnet Address then:

- The HiQnet ID field of a discovered device with a HiQnet Address which conflicts with a HiQnet Address which has already been discovered will be displayed in pink.
- A conflicting HiQnet Address may be edited inline if you want to change the device HiQnet Address.

- When the device is selected and highlighted in orange the field is represented in red.
- The HiQnet address is not displayed, instead a dash is displayed as grayed out.

**Devices not discoverable at the IP level**

A device which is not discoverable at the IP level (invalid IP address etc) will not be able to report a HiQnet address. In this instance, the HiQnet ID field will display a '?' to indicate that the field may exist but that the software does not have enough discoverability of the device to determine the value.

A blank field or '-' implies the value is null. The HiQnet ID field may not be edited inline.

Once edits have been made, it is critical to click the "Apply Current Edits" or "Apply and Exit" buttons.

**Random ID**

The device will be given a random HiQnet address. If you want to set the HiQnet address of a device to a random ID, check the Random ID check box. If the check box is unchecked before applying current edits, the prior HiQnet ID value will be restored.

All devices in the current filter view may be set to Random HiQnet ID by checking the check box in the column header. The individual check boxes for all devices will be checked if a single individual check boxes for all devices is subsequently unchecked the column header Random ID checkbox will be automatically unchecked.

If all devices in the current filter view are set to Random ID on and the Random HiQnet ID column header check box is checked, all devices may be set to Random ID off by unchecking the column header check box. The individual check boxes for all devices will be unchecked.

**Devices not discoverable at the IP level**

A device which is not discoverable at the IP level (invalid IP address etc) will not be able to report a HiQnet address. In this instance, the Random ID check box will be unavailable.

**Status**

Displays the current discovery status of the device. The Status field may not be edited. Discovery status hierarchy is as follows:

- Discovered. If a device has a unique IP address and a unique HiQnet address, this condition will be shown unless the device is access controlled. When the device is not selected, the 'Discovered' label is represented in green.
- IP conflict. If a device has an IP Address conflict, this error will be shown regardless of other status notifications. When the device is not selected, the 'IP conflict' label is represented in blue.
- HiQnet conflict. If a device has a unique IP address yet has a HiQnet address conflict, this error will be shown regardless of other status notifications. When the device is not selected, the 'HiQnet conflict' label is represented in red.
- Locked. If a device has a unique IP address and a unique HiQnet address, this condition will be shown if the device is access controlled. When the device is not selected, the 'Locked' label is represented in yellow.
- Discovering. This condition will be displayed if the device has had changes made to IP configuration or HiQnet address and HiQnet NetSetter is waiting to reestablish connection. When a device being rediscovered is not selected, all fields within the device row are displayed but is grayed out, represented in light gray.

**Discovered** - The 'Discovered' status is determined by the following conditions:

- The device is discoverable at the MAC Address level
- The device has a valid and unique IP Address (manual or DHCP / Auto-IP)
- The device has a unique HiQnet address
- The device is not Access Controlled

**IP conflict** - The 'IP conflict' status is determined by the following conditions:

- The device is discoverable at the MAC Address level
- The device has an IP address which conflicts with another device which has already been discovered by NetSetter

**HiQnet conflict** - The 'HiQnet conflict' status is determined by the following conditions:

- The device is discoverable at the MAC Address level
- The device has a valid and unique IP Address (manual or DHCP / Auto-IP)
- The device has a HiQnet address which conflicts with another device which has already been discovered by NetSetter

**Locked** - The 'Discovered' status is determined by the following conditions:

- The device is discoverable at the MAC Address level
- The device has a valid and unique IP Address (manual or DHCP / Auto-IP)
- The device has a unique HiQnet address
- The device is Access Controlled

When the device has been discovered in the Locked state, a dialog must be displayed to prompt for the Admin password the first time any field is attempted to be edited

- A successful login with the Admin password only will enable all fields to be edited subsequently
- This state may need to be reset on rediscovery after applying current edits, requiring the Admin password to be entered again

**Discovering** - The 'Discovering' status is determined by the following conditions:

- The device had been previously discovered at least the MAC Address level
- Edits had been made to one or more fields
- The device is being rediscovered after applying current edits.

Since the sort order automatically updates when a field within the sorted column is updated, the rediscovered device will occupy the same row on rediscovery. Unless DHCP / Auto-IP or Random ID has been set prior to applying current edits, in which case the rediscovered device will occupy the appropriate row in the current column sort order.

## Device Type

The device class name is displayed, as reported by the discovered device. To the left of each device class name is displayed the brand icon. The software application name is displayed for discovered PCs running an instance of HiQnet software:

- System Architect
- Performance Manager
- London Architect

The Device Type field may not be edited inline

### Devices not discoverable at the IP or HiQnet level

A device which is not discoverable at the IP level (invalid IP address etc.) or HiQnet address level (HiQnet address conflict etc) will not be able to report its class name. In this instance, the Device Type field will display a '?' to indicate that the field may exist but that the software does not have enough discoverability of the device to determine the value.

A blank field or '-' implies the value is null

## Device Name

The user-definable Device Name is displayed, as reported by the discovered device

- May be edited inline if you want to change the Device Name.
- May not be edited for discovered PCs running an instance of HiQnet software.

### **Devices not discoverable at the IP or HiQnet level**

A device which is not discoverable at the IP level (invalid IP address etc) or HiQnet address level (HiQnet address conflict etc) will not be able to report its Device Name. In this instance, the Device Name field will display a '?' to indicate that the field may exist but that the software does not have enough discoverability of the device to determine the value

A blank field or '-' implies the value is null

Once edits have been made, it is critical to click the "Apply Current Edits" or "Apply and Exit" buttons.

Container : Position

The Container and Position Venue Data is displayed (separated by a colon), as reported by the discovered device. The field is left blank for discovered PCs running an instance of HiQnet software.

- System Architect
- Performance Manager
- London Architect

The Container / Position Venue Data may not be edited inline.

A selected device may have its Venue Data cleared (including all Building, Floor and Room Venue data) by pressing the Clear Container button. This action takes place on applying current edits only and can be undone with the Undo Current Edits button

### **Devices not discoverable at the IP or HiQnet level**

A device which is not discoverable at the IP level (invalid IP address etc) or HiQnet address level (HiQnet address conflict etc) will not be able to report its Device Name. In this instance, the Device Name field will display a '?' to indicate that the field may exist but that the software does not have enough discoverability of the device to determine the value

A blank field or '-' implies the value is null

## **Locate**

Clicking in the Locate column for a device will put the corresponding device on the network into a Locate state, and the Locate icon will be displayed.

- Clicking an active Locate icon will disable the Locate state for the device
- Disabling the Locate state from the device will clear the icon
- Devices may be put into Locate state independently from selection so that more than one device can be located at any one time

# Offline/Online

Audio Architect has two define modes of operation: Online and Offline. Offline operation allows the system to be configured without real time changes to the system. In this mode, changes have to be sent to the edited device. In Online mode, changes to amplifiers are made real time.

When Audio Architect first opens, the Offline Design Tab is the ribbon presented, and the Device Toolbox appears on the left and an empty Properties window is at the bottom. The Add Devices box is highlighted. When going Online, it may be necessary to Match Devices and/or Synchronize Venue.

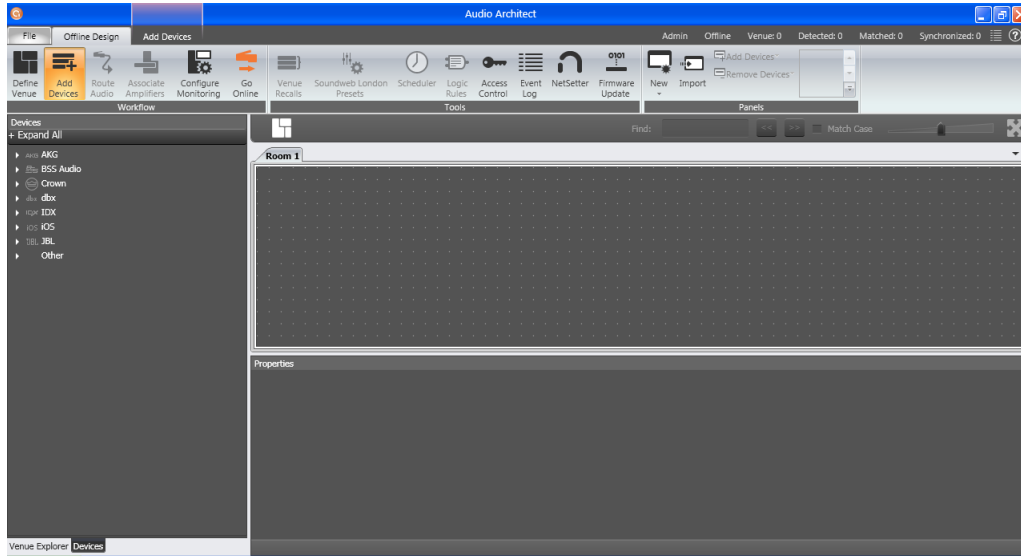

Figure 9

Match Devices allows users to associate amplifiers within their venue design to amplifiers on the network. In the Match Devices tab, the following options are available:

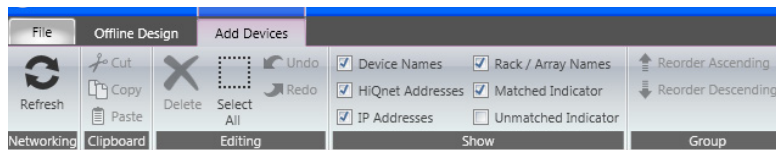

Figure 10

- **Refresh Networking:** Clicking this button will temporarily take Audio Architect offline, then restart the network.
- **Match**
  - Auto-Venue: Automatically enables matching between all the devices in the Audio Architect venue
  - Detach: Removes the device's virtual connection from Audio Architect.
- **Editing**
  - Undo: Erases the last change done, reverting to the previous state.
  - Redo: Re-establishes the previous state.
- **Show:** The checked items are displayed along side the appropriate devices in the venue; Device Names, Rack/Array Names, HiQnet Addresses, and IP Addresses. In Synchronize Venue, each device will be shown with either a Receive icon or a Send icon.
- **Receive** – device settings will be downloaded to the Audio Architect
- **Send** – device setting will be sent from Audio Architect to the device

When going Online, the following options are possible:

1. If one or more devices in the Venue are not matched AND corresponding devices are available on the network, going online lands in Match Devices mode.
2. If all the devices in the Venue are matched, going online lands in Synchronize Venue mode. In Synchronize Venue mode, the user is given the option to either Send data from Audio Architect to the device or Receive data from the device to Audio Architect.
3. If no devices require to be synced, going online lands in Run Venue mode.



Each amplifier can be dragged into the room window. Each device will have a IP address listed on the left of the amplifier and a Name ID on the right on the amplifier. The Name ID can be edited in the properties menu at the bottom of the page. The number to the left of Name ID is the HiQNet Device Address. The green circle only indicates that the amplifier has been discovered on the network. The small box located below the rack allows quick access to amplifier factory panels. These panels include the following items. Note: When a device is added to the window, it is automatically removed from the "Discovered" section.

- Factory Master Panels
- Monitor Panels
- Meter Panels
- Level and Mute Panels

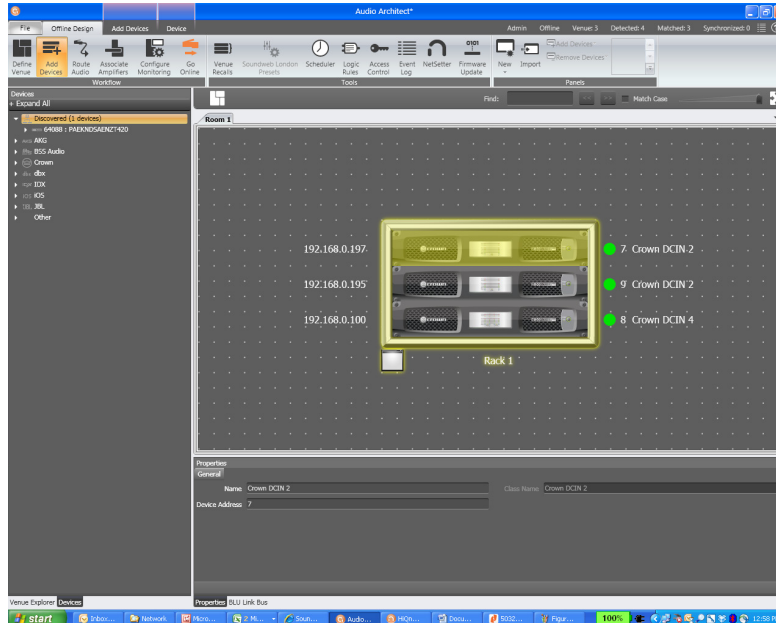

Figure 11

Double clicking an amplifier will access the amplifier factory control panel. At this point, Audio Architect is in OFFLINE MODE. In OFFLINE MODE, amplifier changes are not made in real time and will need to be sent to the amplifiers. Amplifier changes can also be sent in real time in ONLINE MODE. To go to ONLINE MODE, click on the GO ONLINE tab in the Workflow bar menu. RECEIVE and SEND buttons will appear for each device, rack, and room in the design. This gives the user the option to just update a single device, all devices in a rack or an entire venue. Click SEND to load the settings made in Audio Architect to the amplifier. Click RECEIVE to read the settings off of the amplifier to be reflected in Audio Architect.

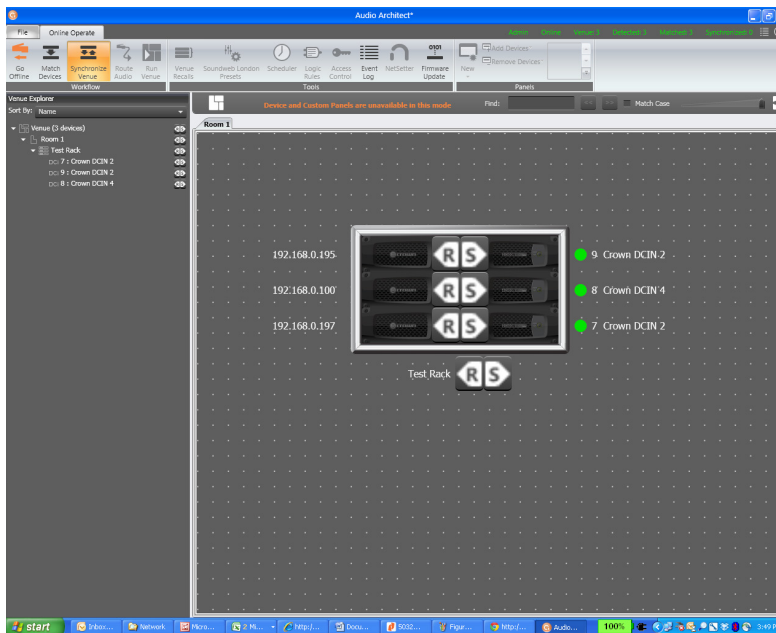

Figure 12

# Set-up and System Configuration

## Amplifier Mode Settings



Figure 13

Figure 13 (above) shows the DriveCore Install 2 channel configuration page. The 4 and 8 channel amplifier configuration pages have the same feature set. The DriveCore Install Network amplifier includes Digital Signal Processing (DSP), multiple input/output routing options and a comprehensive diagnostics feature set. All of these features can be adjusted in from the configuration page.

The DriveCore Install amplifiers are very capable and flexible amplifiers. In the Amplifier Mode Setting window, the following items can be adjusted.

- Hi-Z/Low-Z on an individual channel basis.
- 70Vrms or 100Vrms operation
- Any analog input can be sent to any amplifier output
- Mono Bridge Output - Output pairs can be bridged for mono operation

### Hi-Z/Low-Z

The DriveCore Install Network amplifiers are capable of High Z and Low Z outputs. Each individual channel is capable of Hi-Z or Low-Z operation. To select Hi-Z or Low-Z operation, double click on the mode button, the Amplifier Mode Setting Window will open (see Figure 14). Note: Choosing 70Vrms or 100Vrms is an amplifier global setting, and affects all output channels selected for High-Z operation.

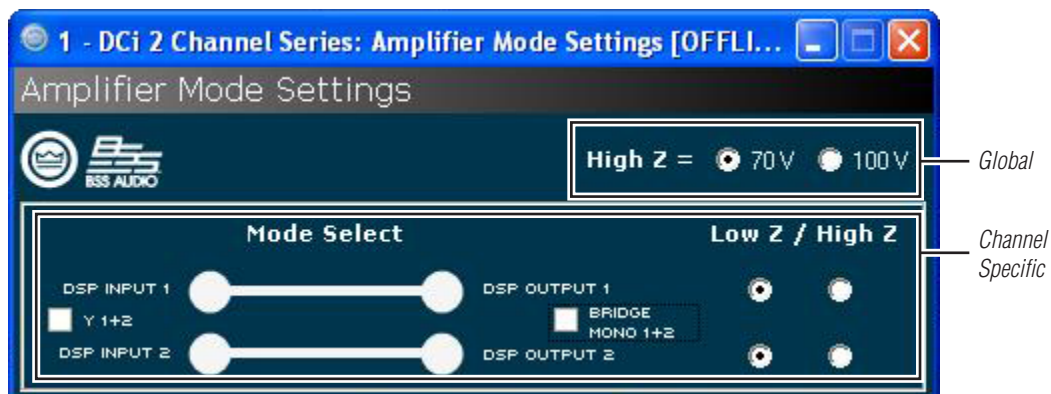

Figure 14

# Set-up and System Configuration

## Cascading Inputs

Cascading the analog inputs, or "Y-ing channels", gives more flexibility to the installation of this amplifier (See Figure 15). One input can be used to drive some or all of the amplifier outputs. NOTE: By cascading the inputs, the corresponding input DSP functions for individual channels will be removed and only the output DSP functions will be available (See Figure 16).

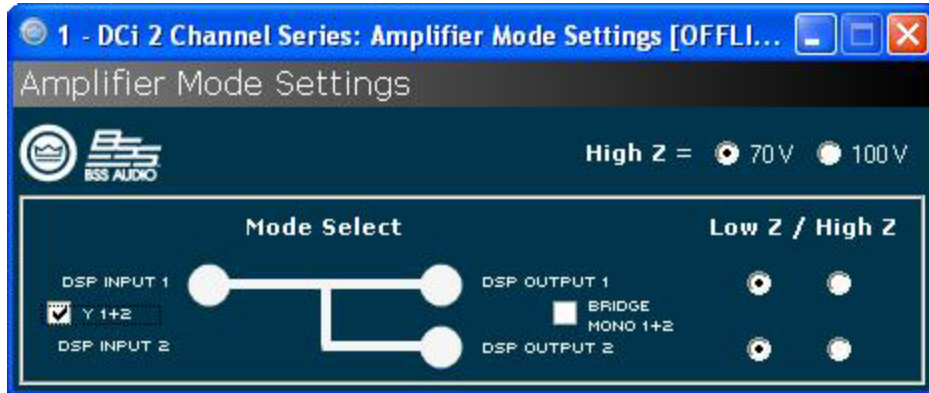

Figure 15 Use the "Y 1+2" etc. check boxes to cascade channel inputs



Figure 16 With the "Y 1+2" box checked, both output Ch.1 and Ch.2 are fed by input Ch.1 and input processing is organized accordingly.

# Set-up and System Configuration

## Bridge Mono Operation

The DriveCore Install amplifier outputs can be bridged to increase the power and voltage available at the output of the amplifier. The amplifier can be bridged in the Amplifier Mode window. By selecting the bridging option, only the first input channel will need to be wired. (See Figure 17). Low-Z and High-Z options are still available. NOTE: If the amplifier output is in bridge mono and the High-Z option is selected, the amplifier will produce 140Vrms or 200Vrms.

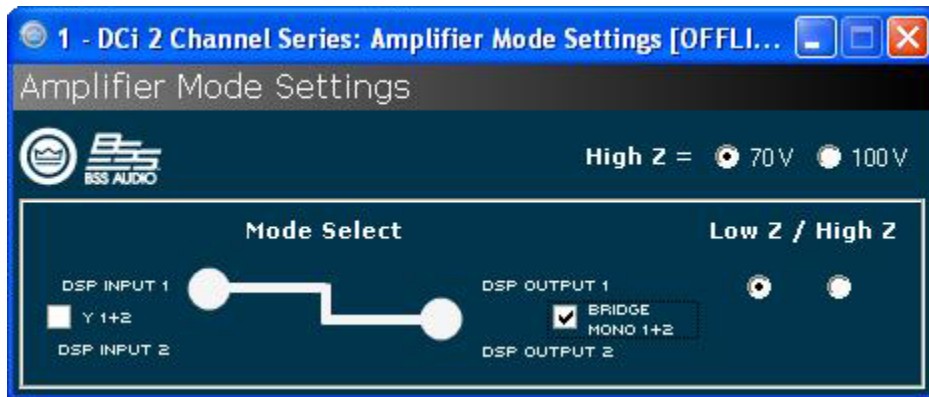

Figure 17



Figure 18

NOTE: By selecting Mono Bridge output, only one channel in the channel pair DSP will be available (See Figure 17).

# Set-up and System Configuration

## Low-Z (8Ω, 4Ω or 2Ω) Output Operation

Typical input and output wiring, along with Audio Architect software settings are shown in Figure 19.

**INPUTS:** Connect the input with wiring in place for each channel. If the same signal is to drive both outputs of a channel pair (“mono”), the input signal can be sent to adjacent amplifier channels. If using the BLU link input, it is important to understand that BLU link is a digital audio bus and cannot be routed through a network switch or router. To increase fault protection, use both the input and output BLU link wiring connection. For BLU link routing, refer to page 33.

**OUTPUTS:** Maintain proper polarity (+/-) on output connectors. Connect the Channel 1 speaker’s positive (+) lead to amplifier Channel 1 positive terminal; repeat for negative (-). Repeat Channel 2 wiring as for Channel 1, and for any subsequent channel pairs on multichannel models. Refer to Page 9 for output connector terminal assignments.

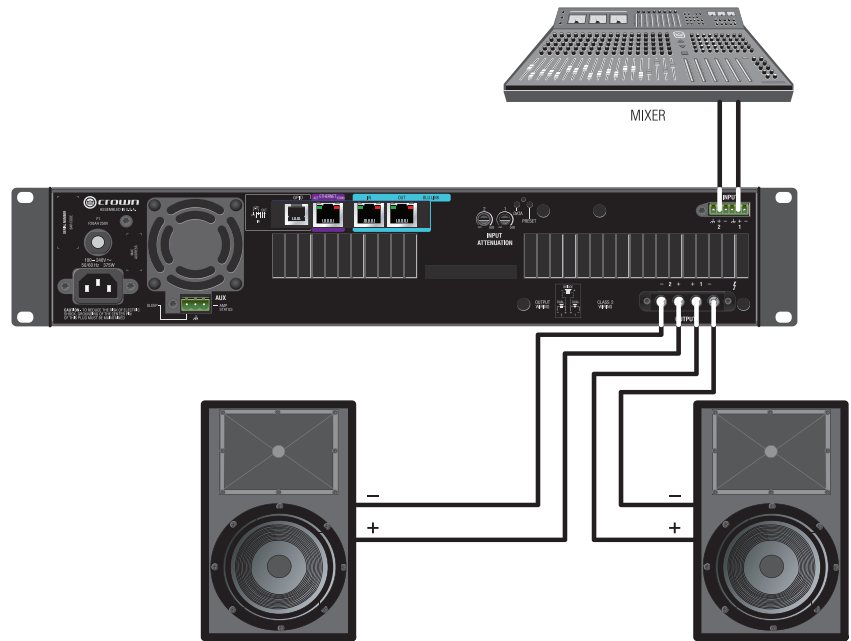

Figure 19 System Wiring Dual Mode

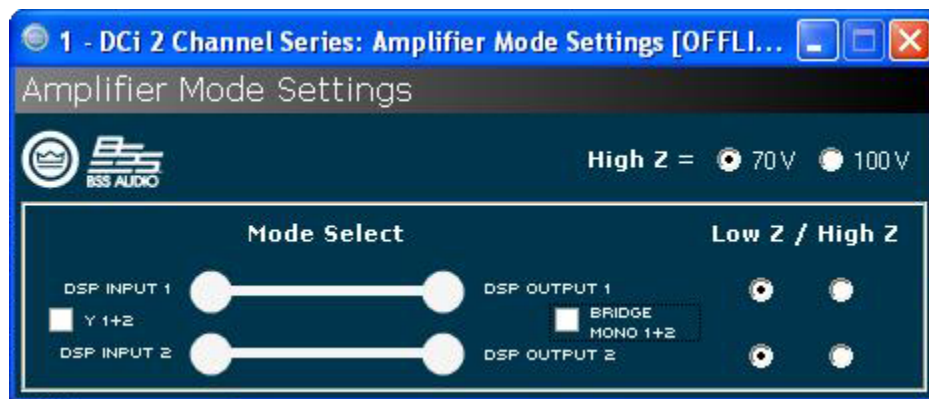

Figure 20

**Always route the input and output wires in separate bundles.**



# Set-up and System Configuration

## Bridge Mode (16Ω, 8Ω, or 4Ω) Output Operation

Typical input and output wiring, along with software settings are shown in Figure 21.

**INPUT WIRING:** If using analog inputs, it is only necessary to wire the odd number inputs. If using the BLU link input, it is important to understand that BLU link is a digital audio bus and cannot be routed through a network switch or router. To increase fault protection, use both the input and output BLU link wiring connection. For BLU link routing, refer to page 33.

**OUTPUTS:** Connect the speaker across the positive terminals of each channel pair. Do not use the negative terminals of the channel pair when the pair is being operated in Bridge Mono mode.



Figure 21 System Wiring Bridge Mode

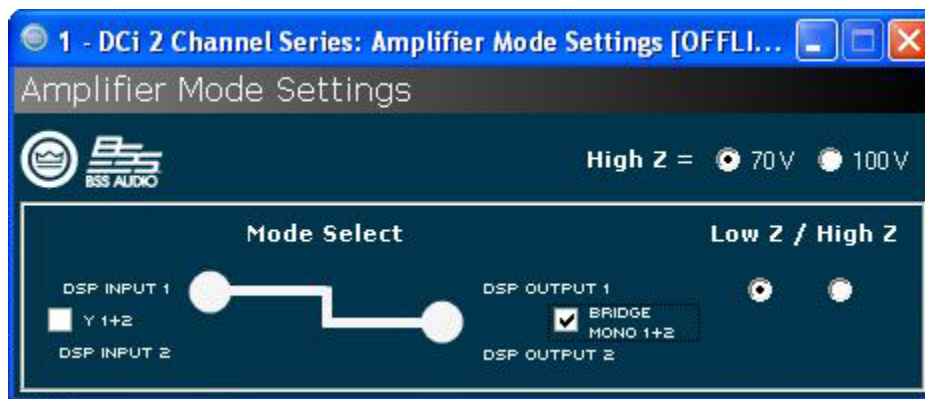

Figure 22 The bridge mono checkbox must be checked for proper operation

**Always route the input and output wires in separate bundles.**

# Set-up and System Configuration

## Dual Mode Hi-Z (70Vrms/100Vrms) Mode

Typical input and output wiring, along with software settings are shown in Figure 23. A 35Hz high pass filter is selected automatically when the amplifier channel is in Hi-Z or Bridged Hi-Z mode. Remember, DCi amplifiers allow each channel Hi-Z or Low-Z mode of operation to be selected independently, while 70Vrms/100Vrms selection is global.

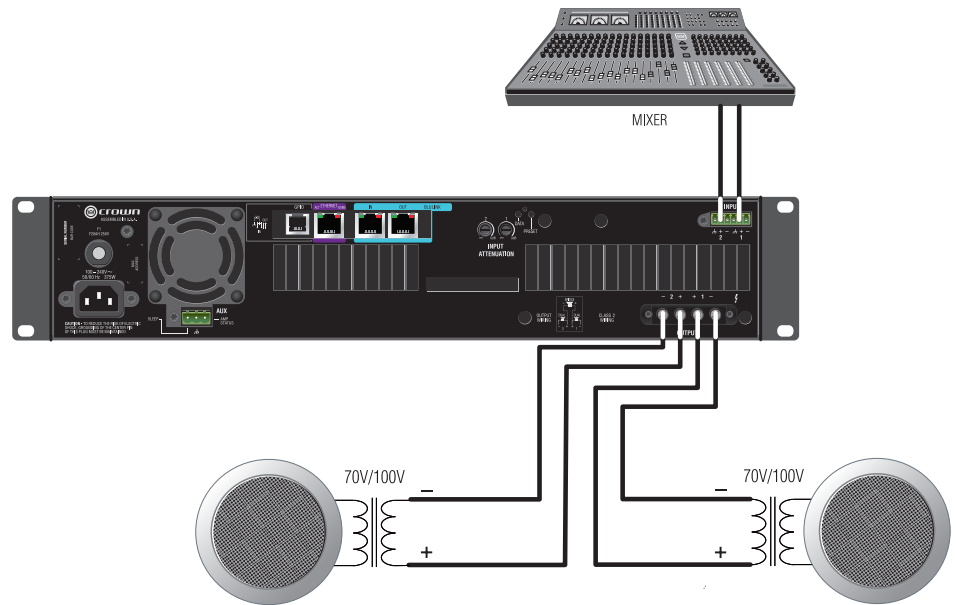

Figure 23 System Wiring for 70Vrms/100Vrms Operation

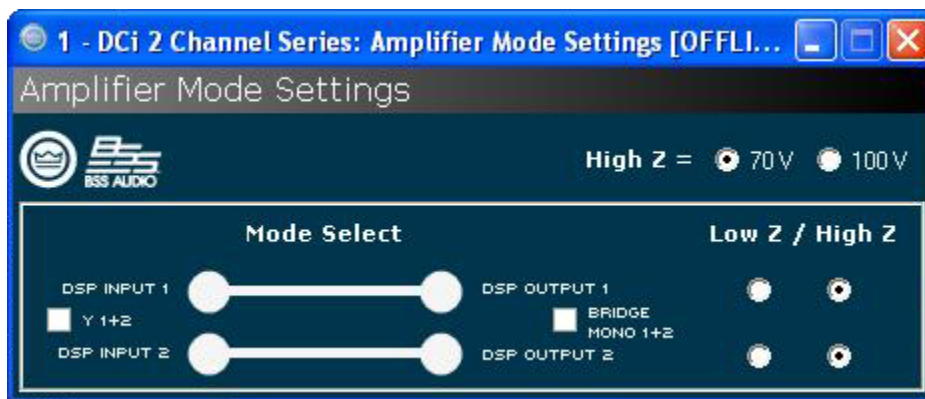

Figure 24

**Note:** 70Vrms/100Vrms is global, while Low-Z/Hi-Z is per output channel

**Always route the input and output wires in separate bundles.**



# Set-up and System Configuration

## Bridge Mode Hi-Z (140Vrms/200Vrms)

**INPUTS:** Connect the input to the odd-numbered channels (1,3,5,7) only. Even-numbered inputs are disabled when the Bridge Mono mode is active.

**OUTPUTS:** Connect the speaker across the positive terminals of each channel pair. Do not use the negative terminals of the channel pair when the pair is being operated in Bridge Mono mode.

**NOTE:** For global selection of 70Vrms (140Vrms bridged) or 100Vrms (200Vrms bridged) operation, refer to Page 25.

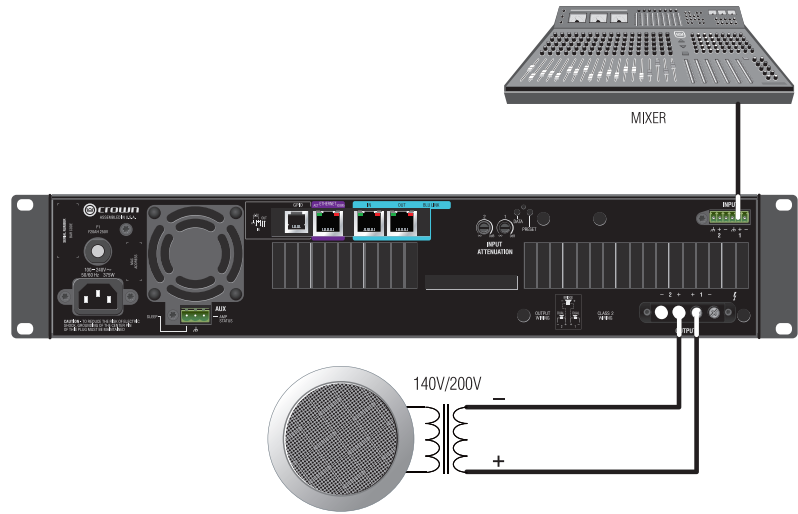

Figure 25 System Wiring for 140Vrms/200Vrms Operation

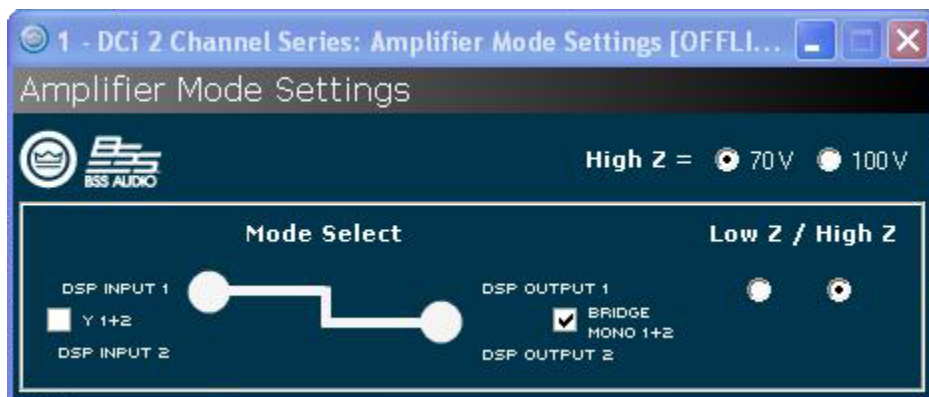

Figure 26

**Always route the input and output wires in separate bundles.**

# General Purpose In/Out Control Port

DriveCore Install Network amplifiers come with a 2-in, 2-out General Purpose In/Out (GPIO) control port in the form of either a 6 position RJ-11 connector (2|300N, 2|600N, 2|1250N, 4|300N, 4|600N, 4|1250N, 8|300N, 8|600N) or a block connector (2|2400N, 4|2400N). The Control Port has multiple functions and uses which include preset selection and gain control, among others.

## Hardware Specification

Inputs are capable of either binary or analog control of a State Variable (SV) within the amplifier. Outputs are binary only that represent an SV of the amplifier. Additionally, outputs can be controlled independently (on/off, polarity) via the software.

**PIN 1:** Output 1. 0VDC to +3.3VDC output. Output impedance = 1K $\Omega$  pullup to +3.3V.

**PIN 2:** Output 2. 0VDC to +3.3VDC output. Output impedance = 1K $\Omega$  pullup to +3.3V.

**PIN 3:** Input 1. 0VDC to +3.3VDC input. Logic = TTL thresholds. Analog = full scale 0-3.3V. Input impedance > 20K $\Omega$ .

**PIN 4:** +3.3VDC output. ILIMIT = 30mA. Output impedance = 100 $\Omega$  to +3.3V.

**PIN 5:** Input 2. 0VDC to +3.3VDC input. Logic = TTL thresholds. Analog = full scale 0-3.3V. Input impedance > 20K $\Omega$ .

**PIN 6:** GND.

---

## Configuration of the Control Port Inputs

2 inputs: Can be variable (connect to potentiometer), binary (connect to switch), or multilevel connect to rotary switch and voltage steps.

- Audio Architect is used to assign up to 40 SV's to each input
- An input mode is selected

**SET** - Sets the assigned SV(s) to a specific value

**VARY** - Continuously varies the assigned SV(s) by a specified value, typically a volume pot application.

**PRESET** - Recalls the max preset in one state (high) and the min preset in the other state (low)

**BUMP** - Similar to vary but implemented with a button instead of a pot. A high level will bump the assigned SV(s) by a specific value.

**AUTOBUMP** - Similar to bump, but will continue to bump the assigned SV(s) value as long as the input state is changed.

Right click on a DCi-N in the venue. Select "Configure Control Ports". A new tab labeled "(amplifier name) – Control Ports" will open.

---

## Software Parameters

**High Limit** – Available only on input, and only for parameters in "Analog Input" mode. This field determines the value that the selected assigned parameter will assume when the control port input is at the maximum end of its range.

**Input** - selects between control port inputs, labeled 1 and 2.

**Low Limit** – Available only on input, and only for parameters in "Analog Input" mode. This field determines the value that the selected assigned parameter will assume when the control port input is at the minimum end of its range.

**Mode** – For the control port input, the Mode field determines how the assigned parameters will be controlled. For the control port output, the Mode field determines the conditions under which the output status will change.

**Off Value** – Available only on input, and only for parameters in "Direct Action" mode. Determines what the value of the selected assigned parameter will be when the control port input is logic "Low".

**On Value** – Available only on input, and only for parameters in "Direct Action" mode. Determines what the value of the selected assigned parameter will be when the control port input is logic "High".

**Output** – Selects between control port outputs, labeled 1 and 2.

**Output Polarity** – Enables selection between "Normal" and "Inverted".

**Parameter Assignment** – List of parameters that are currently assigned to a given control port input

# General Purpose In/Out Control Port

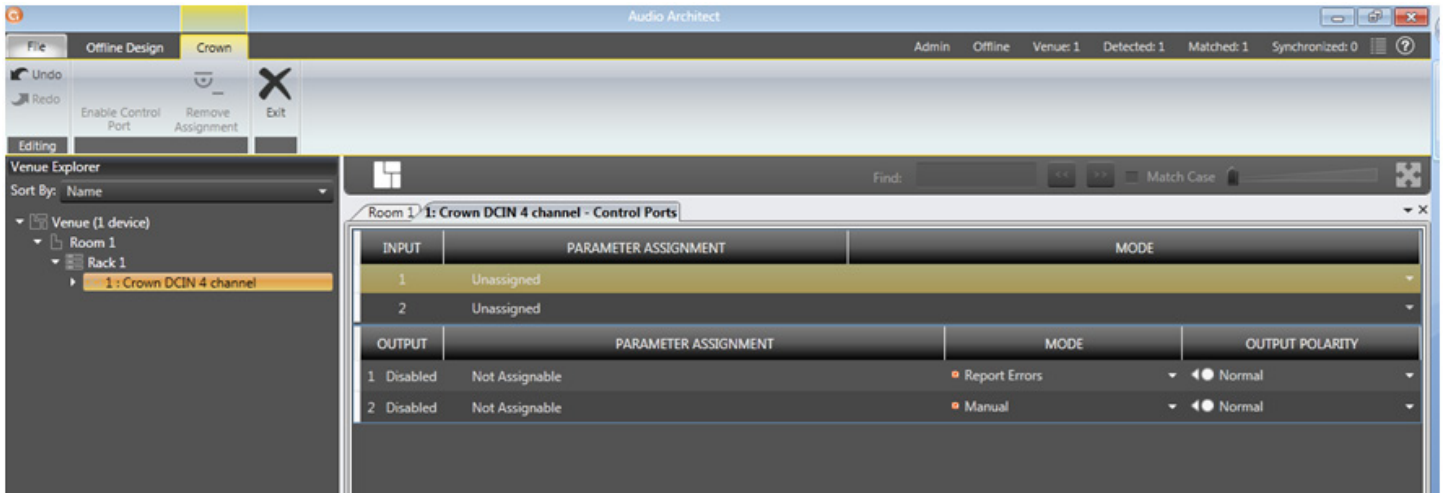

Figure 27 Control Port Configuration Page

In the Venue Explorer, select and expand the device for a list of objects. Expand an object for a list of state variables (SV's) within the object. A state variable can be added to the control port input assignment by clicking and dragging with the mouse into the "Parameter Assignment" tab for either input 1 or 2.

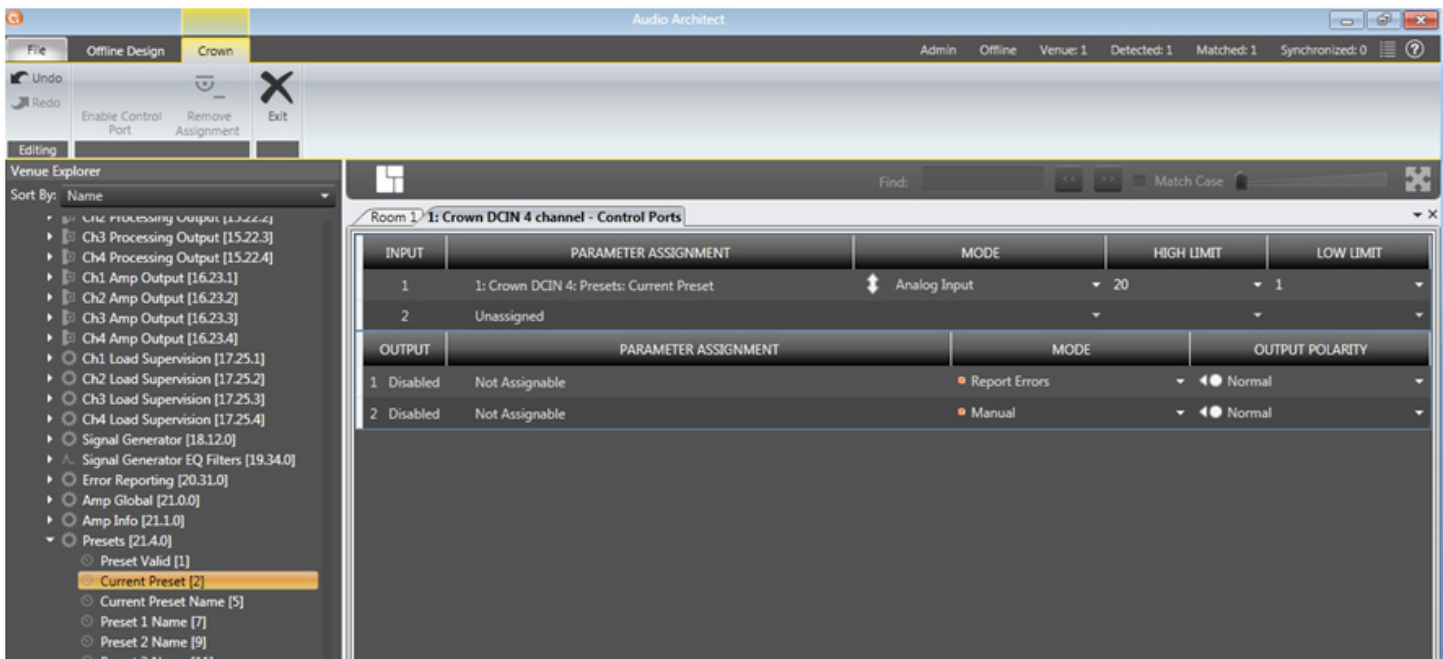

Figure 28 Assigning the "Current Preset" parameter to Control Port Input 1

Once an SV has been added, its type will determine which MODE options become available. If a binary SV has been assigned, only the "Direct Action" mode is selectable, and the "ON VALUE" and "OFF VALUE" parameters can be toggled as desired. However, if a non-binary SV is added, the "Analog Input" Mode becomes available. In this mode, the ON and OFF VALUE fields are unused, and the "HIGH LIMIT" and "LOW LIMIT" fields appear and become accessible. The LIMIT fields allow control of an SV over a specified range.

# General Purpose In/Out Control Port

Additional state variables can be added to a given control port input by selecting the SV and dragging on top of a previously assigned row of the desired input. However, once an SV has been assigned and the MODE has been set, any subsequent SV that is added must function in the same MODE. Up to 40 SV's can be assigned to a given input.

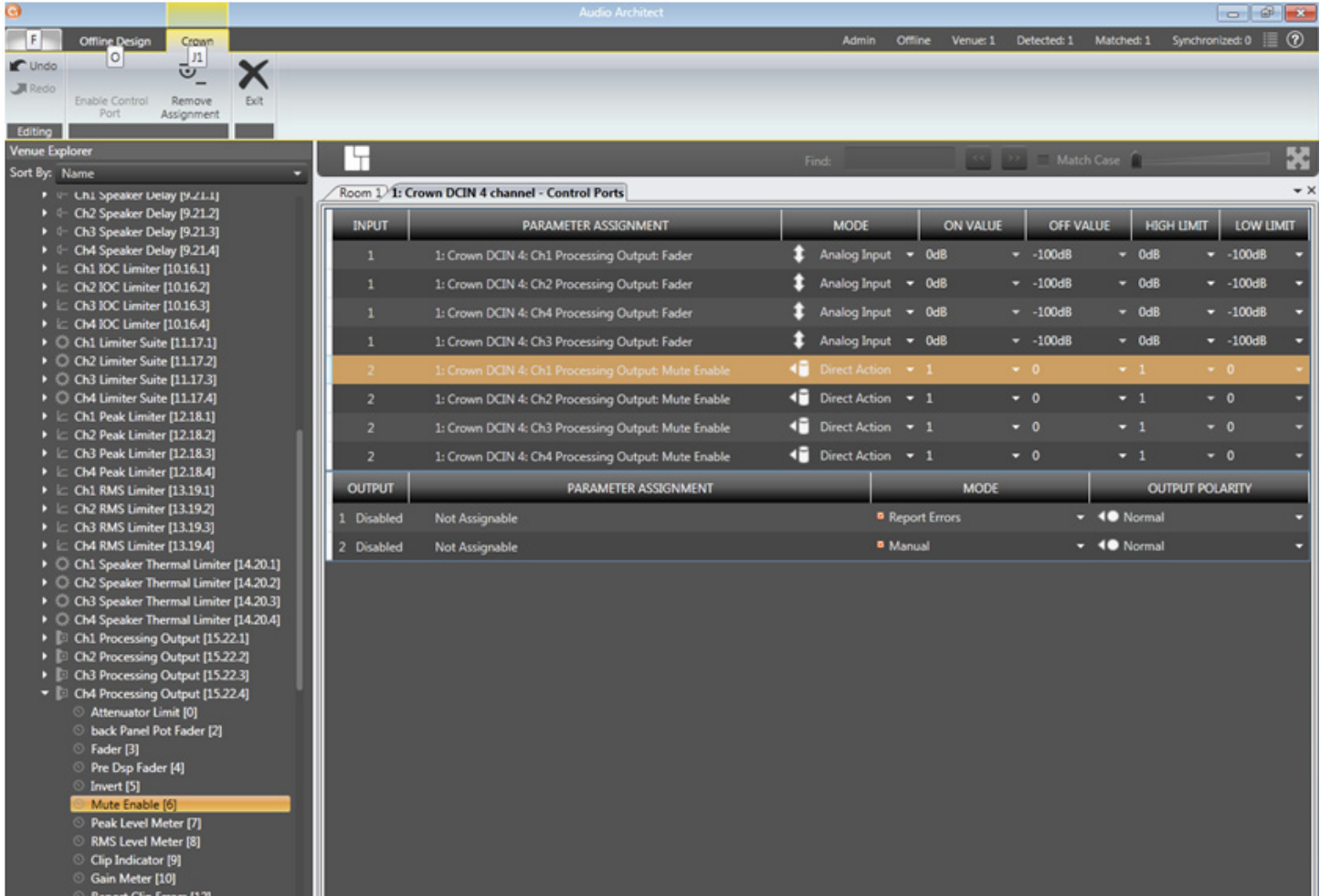

Figure 29 Configuring Input 1 to control Processing Output Faders for Channels 1 – 2, and Input 2 To control Processing Output Mutes for Channels 1 – 2

An assigned state variable can be removed by highlighting and selecting “Remove Assignment” in the upper left hand corner.

# General Purpose In/Out Control Port

## Configuration of the Control Port Outputs

2 outputs: Binary only.

- There is a polarity control on each output so that it may function as active-high or active-low
- Output Mode 1 - Manual: Controlled directly by the output enable button
- Output Mode 2 - Report Errors: Active when any enabled error is reported. The indicator will stay on for up to 60 seconds after the error is cleared. Errors include:
  - Load Supervision
  - AC Line Voltage is out of range
  - Hardware Protection (faults)
  - Over temperature (any channel or power supply)
  - Amp output clipping
  - Processing output clipping (off by default)
  - Analog Input clipping (off by default)
- Output Mode 3 - Report online status: Active when HiQnet connection is lost. The length of time to wait for a time out is user adjustable, default = 60 seconds

The Control Port output configuration options can be found directly below those for the input. No parameters can be assigned to the outputs. Instead, there are three modes available: Manual, Report Errors, and Report Online Status. Manual mode enables direct control over the selected output. In "Report Errors" mode, the output status will change if any errors are reported to the network, such as clip errors, temperature errors, line voltage errors, etc. Finally, in "Report Online Status" mode, the output status will change if no network communication is detected for at least 60 seconds. The control port output does not turn off right away when reporting errors or online status. There are several reasons for this. The online status does not change quickly, it can take up to 60 seconds to drop offline or to recover. In these modes, the output is intended to be used with devices such as a backup amp switcher or an electro-mechanical system. We want to prevent this output from toggling on/off quickly. It may take the output up to 90 seconds to recover (i.e. switch states) from an error or loss of connection.

# General Purpose In/Out Control Port

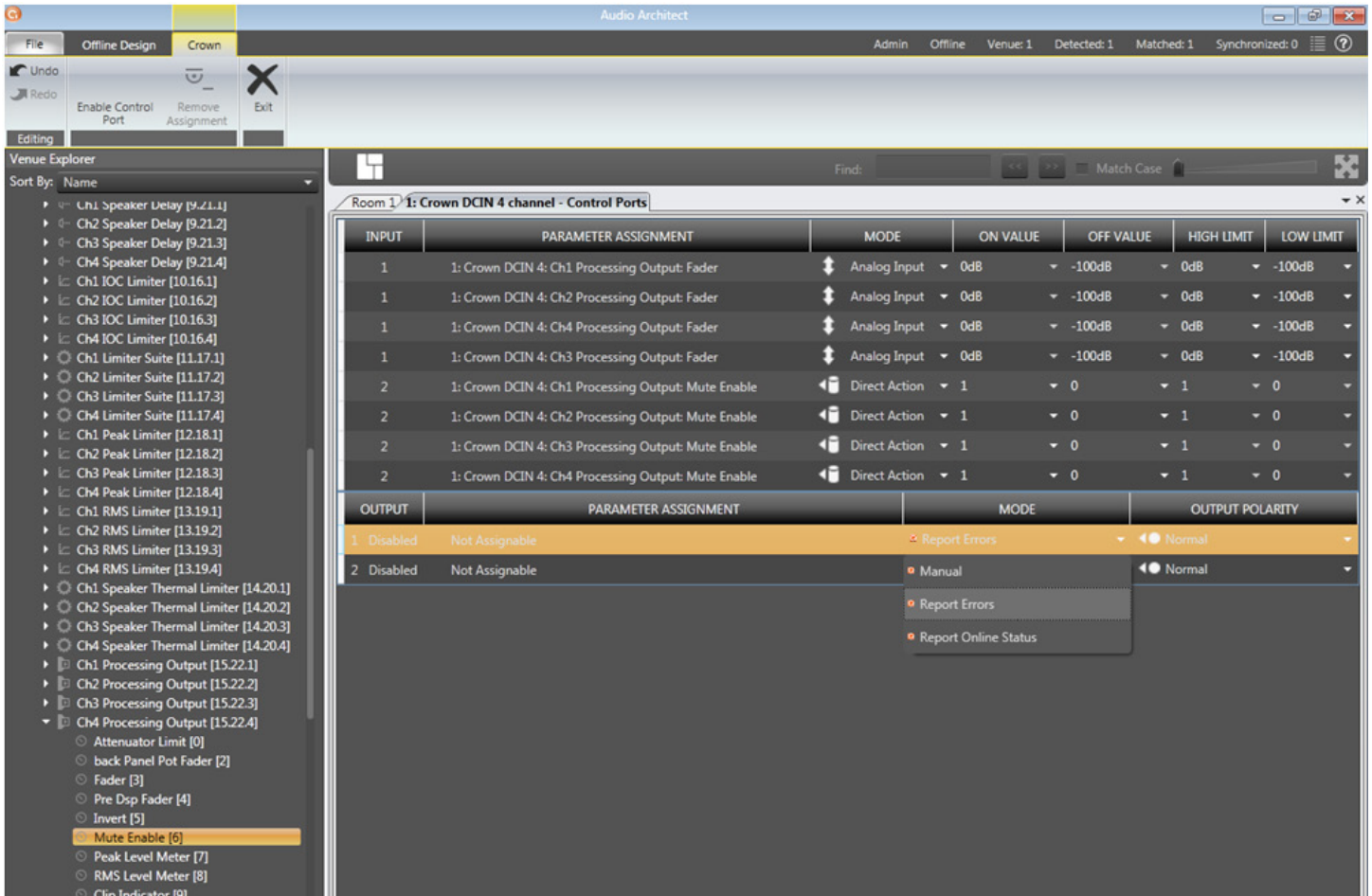

Figure 30 Control Port Output Configuration

NOTE: In all modes, the polarity of the binary output can be toggled under the OUTPUT POLARITY tab, where “Normal” or “Inverted” can be selected.



# Aux Port/Sleep/Amp Status

2|300N, 2|600N, 2|1250N, 4|300N, 4|600N, 4|1250N, 8|300N, 8|600N

---

## AUX Port

The AUX port can be used for basic monitoring of the amplifier and for remote standby. The port is a 3 pin block connector with pin-2 used as ground.

---

## Sleep

The amplifier can be put to sleep by connecting pins 1 and 2 together on the AUX port. When applying this connection, the amplifier will shut down and remain in sleep until the connection between pins 1 and 2 is open. While the amplifier is in sleep, the front panel power button is disabled. When the connection between pins 1 and 2 is open, the amplifier will revert to its last configuration and begin to output audio within 20 seconds. Communication via the network will take as long as the network interface card boots. If the front power button is pressed while the amp is in sleep mode, the blue power indicator will blink twice.

---

## Amp Status

AMP STATUS can be used for basic monitoring of the amplifier. Monitoring of the amplifier can determine if the amplifier is operating within optimal parameters or if the amplifier has been shut off or is in fault. Between pins 2 and 3, there will be either a +5VDC potential or a 2Hz square wave (heart beat). This option can be found in the AMP INFO button on the main amplifier page within Audio Architect..

---

2|2400N, 4|2400N

---

## AUX Port

The AUX port can be used for basic monitoring of the amplifier and for remote standby. The AUX Port is combined with the GPIO block connector, with pin-6 used as a shared ground between the GPIO and the AUX Port.

---

## Sleep

The amplifier can be put to sleep by connecting pins 8 and 6 together on the AUX port. When applying this connection, the amplifier will shut down and remain in sleep until the connection between pins 8 and 6 is open. While the amplifier is in sleep, the front panel power button is disabled. When the connection between pins 8 and 6 is open, the amplifier will revert to its last configuration and begin to output audio within 20 seconds. Communication via the network will take as long as the network interface card boots. If the front power button is pressed while the amp is in sleep mode, the blue power indicator will blink twice.

---

## Amp Status

AMP STATUS can be used for basic monitoring of the amplifier. Monitoring of the amplifier can determine if the amplifier is operating within optimal parameters or if the amplifier has been shut off or is in fault. Between pins 7 and 6, there will be either a +5VDC potential or a 2Hz square wave (heart beat). This option can be found in the AMP INFO button on the main amplifier page within Audio Architect..

---



# BLU link

## BLU link

BLU link is an audio bus found on the DriveCore Install Network amplifier series. It carries 256 channels of audio at 48kHz, and 128 channels at 96kHz, both at 24bit. When connected in a loop, it has redundancy, allowing any one BLU link cable to break while still maintaining audio.

---

### BLU link Specification

- Based on Gigabit Ethernet technology
- 100m over CAT5e cable between each point.
- >100m using fibre converters.
- 256 Channels at 48KHz
- 128 Channels at 96KHz
- Bus-like architecture. Audio transmitted on a channel is available at all other devices on the network automatically.
- Wired in a loop for redundancy
- Recovers from a single cable break

---

### Hardware Configuration

On the rear of the BLU link devices there are two BLU link ports. One is the BLU link In, and the other BLU link Out. Devices are connected together by wiring Out to In on all of the devices within your BLU link network, making sure that the loop is complete so that there are no empty BLU link ports. You should not connect the BLU link ports to anything other than BLU link ports. BLU link will not function if you try to connect the BLU link to an Ethernet switch for example.

---

### Fault Tolerance

The network is capable of a degree of fault tolerance due to the fact that each device receives the same audio from 2 other devices. If a cable is broken the devices which are no longer connected will detect the cable break. One device will detect that its 'In' port is unconnected and the other will detect that its 'Out' port is undetected.

NOTE: when the cable is broken, the audio takes longer to reach its destination than before. This added delay is not compensated for in any way, but is a side-effect of the way the fault tolerance works.

---

### Mastership

The BLU link network requires one device on the ring to act as master for the whole ring. The master will provide the clock for all the other devices on the ring. This means that the whole ring is synchronised to a single audio clock.

In certain cases, it is possible to utilize devices of more than one Ethernet transport type (AVB, CobraNet™, or Dante) connected within the same BLU link ring. In other words, if you're careful, you can design a Harman system which actually includes more than two transports. For example, it's possible for a Harman system to have CobraNet audio being converted to BLU link audio (BLU-800 and BLU-320 both have the ability to "bridge" CobraNet to/from BLU link), which is then converted to Dante audio (BLU-806 and BLU-326 both have the ability to "bridge" BLU link to/from Dante). It all depends on a given transport's ability to "slave" (AKA "re-clock") to a clock being generated by a separate transport.

*Can it be "slaved" to the clock of another transport?*

AVB	No
BLU link	Yes
CobraNet	No
Dante	Yes

The previous chart has critical implications on system-design when combining two or more transports. Any system based on Soundweb London (including Architectural Media Systems) supports the following five multi-transport combinations:

- BLU link + AVB (AVB provides the clock)
- BLU link + CobraNet (CobraNet provides the clock)
- BLU link + Dante (either BLU link or Dante provides the clock)
- BLU link + Dante + AVB (AVB provides the clock)

# BLU link

Any multi-transport combination NOT specifically listed above is not allowed in Soundweb London systems (without being forced to use analog interconnects between transports). For example, BLU link + AVB + CobraNet is NOT allowed, because the AVB and CobraNet networks would each be synced to different clocks—their own.

Mastership is negotiated between all the devices on the ring, and change to the ring will trigger the negotiation to be started. There are various rules for determining which device on the ring becomes clock master :

- If there is only one device connected to CobraNet/AVB then that is master.
- If there are multiple devices connected to CobraNet/AVB, then they compare master priorities.
- If there are multiple devices on CobraNet/AVB with the same highest priority, then they use MAC address to decide which is master.
- If there are no devices connected to CobraNet/AVB, then they first compare master priorities. Next, if the priorities are the same, they compare MAC addresses.

## BLU link LED indicators

These are found on the BLU link ports on the back panel of the device and indicate the following:

- Green LEDs

The green LED will indicate a link on that particular port

- Orange LEDs

Both on: The box is the master. (No green LEDs will be on if no cables are connected).

Only one on: The box is locked to the data coming in on that particular port

Both off: Boxes not locked

## BLU link Routing

The DriveCore Install Network Amplifiers series can utilize both analog and/or BLU link inputs

The DriveCore Install Network Amplifiers series can utilize both analog or BLU link inputs. To configure the input section of the amplifier, Input Icon > Source Routing > Input Configuration. This page allows you to make changes to the levels of the various sources. This feature allows you to not only adjust for different signal levels from the source (i.e. analog is quieter than BLU link ) as well as being able to be used for an additional location of gain if needed. The meters on this page allow you to see both Peak and RMS levels. You are also able to set the maximum input level for the amplifier which will affect both channels. Rx Status lights below each BLU link input channel provide confirmation of slot assignment.

NOTE: Gain Mode for the analog inputs can be used to maximize the Signal to Noise Ratio.

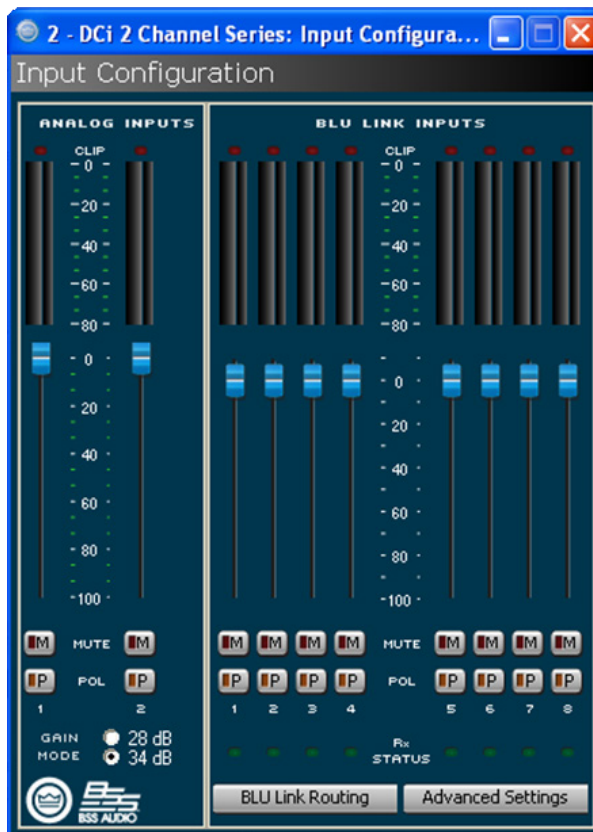

Figure 31 Input Configuration

# BLU link

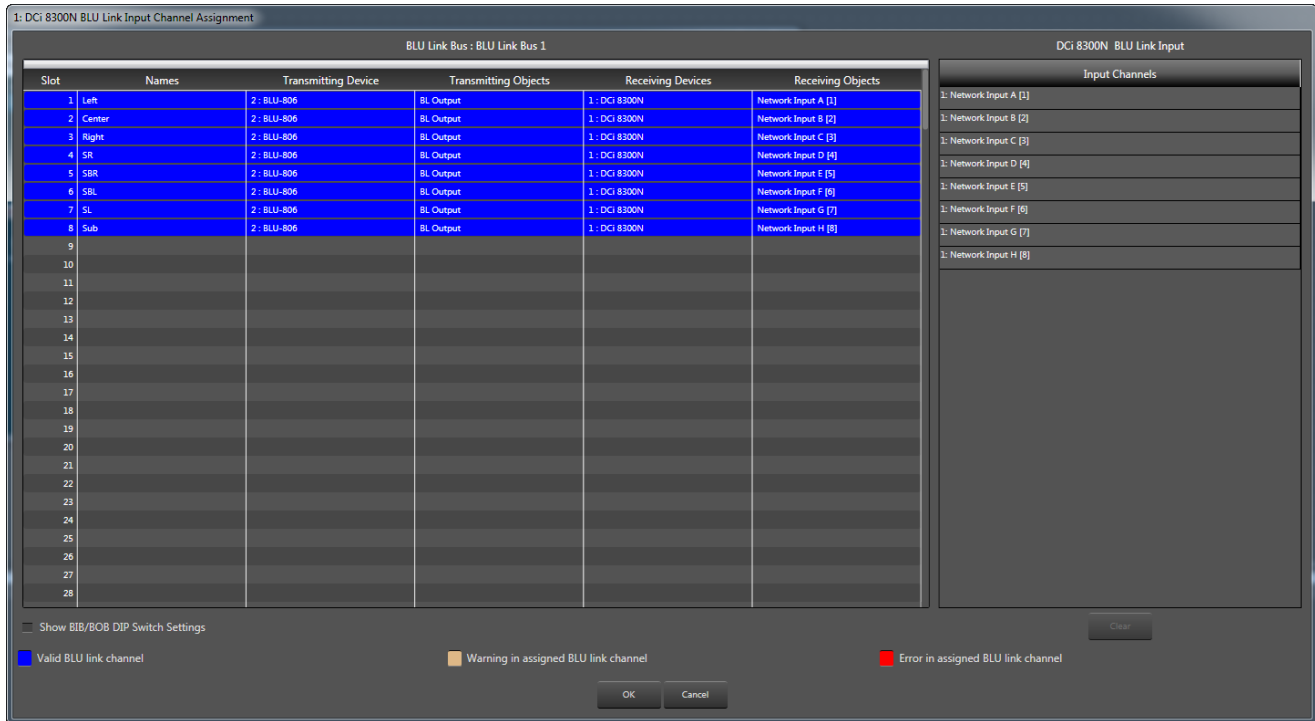

Figure 32 BLU link Input Channel Assignment

## BLU link Routing

Double-clicking on the BLU link Routing button opens the BLU link channel assignment dialogue. The DCi-N amplifiers have 8 'slots' (labeled A through H) available for receiving a BLU link audio stream, which can then be sent to any one of the channels in the amplifier via the Source Routing panel. Click and drag a stream from the list of BLU link channels on the left, and drop it into one of the 8 channel slots (A-H) available on the right side of the dialogue labeled Output Channels. Then go to Source Routing to assign that audio stream to an amplifier channel by selecting BLU link Input A through H from the dropdown menus presented. If you know the BLU link channel number you want to use, it can be assigned to a slot (A-H) on the Input Source Routing window by typing the BLU link channel number into the field next to the desired input slot letter. Press enter after entering the number for changes to take effect

## Output Configuration

Double-clicking on the BLU link Routing button opens the BLU link channel assignment dialogue. The DCi-N amplifiers have 8 'slots' available for receiving a BLU link audio stream, which can then be sent to any one of the channels in the amplifier via the Source Routing panel. Click and drag a stream from the list of slots on the left, and drop it into one of the 8 channel slots available on the right side of the dialogue labeled Output Channels. Then go to Source Routing to assign that audio stream to an amplifier channel by selecting BLU link Input 1 through 8 from the dropdown menus presented.

# BLU link

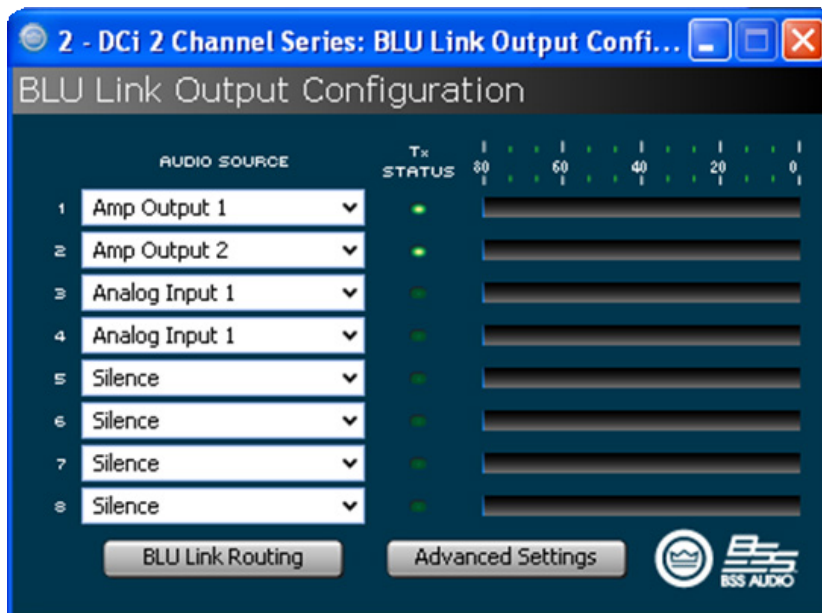

Figure 33 BLU link Output Configuration

The analog inputs for the DriveCore Install Network amplifier provide additional flexibility when for the BLU link digital audio bus. From the BLU link Output Configuration window (Input Icon >Source Routing > BLU link Output Configuration), it is possible to utilize the DCi-N amplifier to be a BLU link On-Ramp in two different ways:

Send unprocessed audio from the analog inputs of the amplifier to 1 of the 8 available BLU link outputs

NOTE: The audio from the analog inputs passes through the amplifier input gain stage (affected by selecting 28dB or 34dB of gain), and then through the input trim and polarity switches in the Source Routing - Input Configuration panel, before being sent to the BLU link bus.

Send post-processing audio from a DCi-N amp channel to 1 of the 8 available BLU link outputs

NOTE: The post-processing audio is bussed from a point at the end of the entire channel processing chain in the DCi-N. This is effectively analogous to taking the audio from the physical output of the amplifier feeding a loudspeaker, and routing it onto the BLU link network.

After selecting an Audio Source in the dialogue shown above, double-click on the BLU link Routing button. It is absolutely necessary to take this additional step, which allows the 8 BLU link output slots inside DCi-N to then be routed onto one of the slots available on the larger BLU link audio ring.

**NOTE - BLU link OUTPUTS (ON-RAMP FROM DCi-N TO BLU link ) ARE DISABLED WHEN THE BLU link NETWORK IS OPERATING AT 96KHZ SAMPLING RATE**

When attached to a BLU link network running at 96kHz, DCi-N will not be usable as an on-ramp. The amplifier will be able to receive a full compliment of up to 8 streams to send to the input router, but it will not be able to send any analog or post-processing audio signals back onto the BLU link network.

**Latency using BLU link in DCi-N**

Path	Total Latency (for selected path)
Analog Input to Amplifier Output	1.67ms
Analog Input to BLU link Output	1.0ms
48khz BLU link to Amplifier Output	2.47ms
96khz BLU link to Amplifier Output	2.27ms

See the section on BLU link Settings for more information about operation at different sample rates, mastership priority, and for more help on BLU link audio.

# Advanced Operation

## Introduction

Your DriveCore Install amplifier has a wide variety of onboard Digital Signal Processing (DSP). HiQnet Audio Architect software lets you adjust the DSP settings, such as filter slope, compression ratio, EQ frequency bands, and so on.

A **preset** is a group of DSP settings that configure the amp for a specific application. For example, you might use one preset that optimizes the amp's DSP for a JBL tri-amplified speaker setting. You might use another preset that sets up the DSP for a stereo pair of loudspeakers of your choice. You can choose any of 20 presets.

---

## Amplifier Presets and Speaker Tunings

Preset 1 is the factory default preset and cannot be overwritten. It sets up the amplifier for pass-thru operation with no DSP features enabled. The DriveCore Install amplifier works with two types of presets:

**User presets** – Using Audio Architect, you can create your own custom DSP presets, label them, and send them to the DriveCore Install amplifier. The amp stores those presets in firmware.

**Downloadable Presets** – Available for download from a variety of manufacturers, these presets are configured for optimal performance and can be sent to the amplifier via Audio Architect.

---

## User Presets

User presets are DSP presets that are configured manually. The following three steps outlines setting up User Presets.

1. Adjust the DSP settings as desired in the Audio Architect software.
2. Save this group of settings as preset, you will be prompted to name it.
3. Download the preset to the DriveCore Install amplifier. See the software Help file for details. As soon as you save the setting as a preset, it is sent to the amplifier.

# Advanced Operation

## Speaker Tunings

Crown and JBL engineers have designed DriveCore Install DSP settings that are optimized for various JBL loudspeakers. Speaker tunings can be downloaded at the following website: [www.jblpro.com](http://www.jblpro.com). An improved speaker tuning approach has been developed for the DriveCore Install Network Series. The system is software library based rather than device preset based. The new approach offers significant benefits:

- Unlimited number of tunings organized into an unlimited number of libraries
- Simple and fast drop-down tuning recall/store/delete within device GUI
- Channel/band specific tunings – no more managing tunings across channels or amp chassis. Also yields logical one-to-one correlation of amp output to transducer/band.
- Faster tuning load/store times – much easier to compare and run A/B tests on multiple tunings without audio dropouts
- Library based – allows logical groupings and archiving of similar tunings (e.g. Screen Array Series or VTX Series, etc.)
- Tunings can be held within but are de-coupled from device presets. Eliminates concern of accidentally deleting or changing other device parameters – speaker tunings only contain the parameters required for speaker tunings! Now presets can be used for complete device configurations – as intended.
- Simpler and faster third-party and user tunings and libraries development – more people will be willing to develop custom or 3rd party tunings
- Single panel access to all required tuning parameters – easier/faster to create/modify tunings.

---

## Speaker Tuning Panel

A new “speaker tuning” icon is implemented on the main device panel for each channel of DCi amplifiers. Double-clicking the speaker tuning icon will open the basic Speaker Tuning Panel (STP).

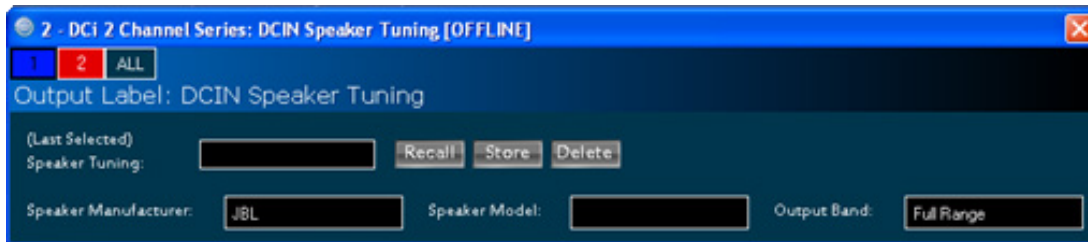

Figure 34 Basic Speaker Tuning Panel

Basic STP functions are:

### Recall

Loads the selected tuning from the working library (drop-down list) into the respective channel.

### Store

Stores the STP settings from the respective channel into the working library with specified user name. The stored tuning is then available in the drop-down list for any other channel or amp.

### Delete

Deletes the selected tuning from the working library.

### Speaker Manufacturer

This parameter displays a text description of the respective speaker manufacturer (i.e. JBL, Custom, etc.). The data for this parameter is stored within the tuning and also within the device settings.

### Speaker Model

This parameter displays a text description of the respective speaker model (i.e. 3722, Three-Way, etc.). The data for this parameter is stored within the tuning and also within the device settings.

### Band

This parameter displays a text description of the respective tuning band (i.e. LF, MF, HF). The data for this parameter is stored within the tuning and also within the device settings.

### Tool Tips

The Mfr, Model and Band text fields are displayed in the tool tip box when the mouse is hovered over the respective channel Speaker Tuning Icon.

# Advanced Operation

Advanced STP functions are available to create/modify speaker tunings. Holding CTRL-ALT-SHFT while double-clicking the speaker tuning icon opens the advanced panel. See Figure 25

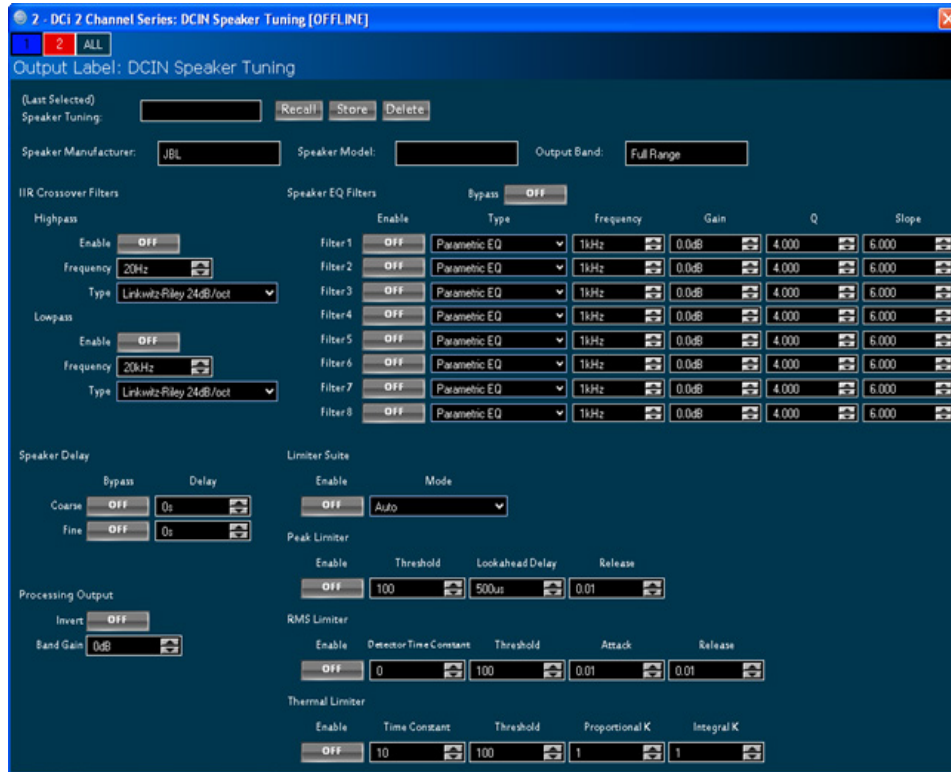

Figure 35 Basic Speaker Tuning Panel

The advanced panel includes every parameter implemented in a speaker tuning :

1. All parameters from basic panel (Recall, Store, Load, Delete, Mfr Name, Model, Band)
2. Crossover Filters (HP lower band-edge, LP upper band-edge, 18 types up to 48dB/oct)
3. EQ Filters (8 second order filter sections, 11 types, full parametric control)
4. LevelMax Limiter Suite (Peak, RMS, Thermal Limiters, Auto/Manual modes)
5. Delay (Fine adjustable from 0S to 0.1S, Coarse adjustable from 0S to 2S)
6. Band Gain (adjustable from -100dB to +20dB in 0.5dB steps)
7. Polarity/Invert

## Speaker Tuning Libraries

The new system uses software based Speaker Tuning Libraries. Audio Architect manages these libraries within the device DLL. A library can contain any number of tunings. Audio Architect can manage any number of libraries. The library system implemented includes:

## Working Library

The working library is opened and active when opening any Speaker Tuning Panel. The working library is automatically updated with the latest stored tunings/settings when exiting the open STP. Audio Architect is installed pre-configured for DCi amplifiers with a working library previously loaded with JBL Screen Array tunings from the JBL Master Screen Array Library. Note: Multiple STP's can be opened but only the last parameters on the last panel closed are saved to the working library.



# Advanced Operation

## JBL Master Screen Array Library

This library is included with Audio Architect at install. The tunings in this library were developed and validated against previous same tunings for Crown DSI amplifiers. It is read-only to prevent over-write. At any time, a user can load this library to access reference JBL tunings for these devices.

## User Libraries

At any time, the user may save the current working library to a custom user library file.

## Loading a Library

Click on the File/Open > Speaker Tuning dialog on the device main panel to open and load an existing library file into the working library. This action replaces the current working library. Any changes not saved to the existing working library will be lost.

## Saving a Library

Click on the File/Save > Speaker Tuning dialog on device main panel to save the current working library to any filename. Note: JBL files are write-protected/read-only and cannot be over-written.

## Library File Locations

The file location and naming conventions for all speaker tuning libraries is:

- Windows 7 and Windows 8.1 path C:\ProgramData\Harman Professional\Audio Architect\
- Windows XP path C:\Documents and Settings\All Users\Application Data\Harman Professional\Audio Architect\

## Library Filename Conventions

The general file names are:

- Working Library: Crown Library.DCi Series.SpeakerTuning
- JBL Screen Array Library: JBL Master Screen Array Library.DCi Series.SpeakerTuning
- User Libraries: Any\_user\_file\_name.DCi Series.SpeakerTuning

# Advanced Operation

## Software-Controllable Onboard DSP

Crown DriveCore Install Network amplifiers have Digital Signal Processing built into the amplifier.

When you use a DriveCore Install Network amp, the loudspeaker processors, crossovers, limiters and delays are in the onboard DSP – so discrete rack mount devices are not needed. This drastically cuts setup time, commissioning, rack space and costs. The DriveCore Install Network DSP can be monitored and controlled with a computer running Audio Architect software, and connected to the amplifier Network Connector by a Category 5 Network cable.

Some applications for this DSP are:

- Configure signal flow
- Optimize system gain structure
- Configure speaker configurations (set the drive levels, frequency bands, delays and limiting for your particular speakers)
- Configure EQ, filtering, and much more.

See the Audio Architect Help files for more detailed information.



Figure 36

On the left of this screen is the Input and Output Signal Level Monitor (explained later on this page). On the right side are rows of DSP selection buttons for each channel. When you double click on a button, a control panel opens for that button's function.

Also on the right are buttons that open control panels for these functions:

- Amplifier mode
- Signal generator (pink noise and sine wave)
- Amplifier information
- Recall and store presets
- Preset manager
- Apply to others (apply this amplifier's DSP settings to other devices)

We'll explain each of these functions on the next several pages.

# Advanced Operation

## Input Level, Faders, Mute, Link, I/O Level Meters, and Indicators



Figure 37

This panel is on the left side of the DriveCore Install Network main control panel shown above. Channels 1, and 2 Level Controls set the input signal level of each channel. Each channel can be muted, and both faders can be linked with the Link button.

### Input Signal Level Meter (green)

The measurement range is from 0dBFS to -40dBFS with 0.5dB resolution. Each audio channel has the following monitors:

- Switched Audio Input: This meter shows only the switched (selected) audio input after the Input Audio Router.
- Clip Indicator
- Peak + RMS levels

### Output Signal Level Meter (blue)

The measurement range is from 0 dB to -40 dB with 0.5 dB resolution. The monitors are scaled so that 0 dB is referenced to the full rated output voltage of the amplifier. The wider left meter is rms and the right meter is peak for each channel. An output clip indicator is provided.

### Indicators

- Temp: Lights if the temperature of the amplifier is too high and the amplifier is near shutdown.
  - Green: Thermal headroom used up is less than 59%.
  - Yellow: Thermal headroom used up is 60-80%.
  - Red: Thermal headroom used up is more than 81%.
- Limit: Lights when the amplifier signal is being limited.
- Load: Lights when the load impedance is out of range.
- Ready: Lights when the amplifier is on and ready to supply power.
- Fault: Lights when the amplifier is in a fault mode service may be required.

# Advanced Operation

## Input Signal Router

Each channel of the DriveCore Install signal processing has an Input Signal Router that lets you choose the audio signal that will be used by the channel.

- **Analog Audio:** This selection set up the input router for analog sources. Each output channel will select its corresponding analog input. Choices for the Analog Audio input are Channel 1, Channel 2, or a sum of Channels 1 and 2. Selecting Analog only will automatically change the MEDIUM input source to none.
- **BLU link Digital Audio:** This is the audio input from the BLU link connector on the back panel of the amp. Each amplifier has 8 BLU link input channels, plus 4 pairs of BLU link summed channels. This does not represent the BLU link channels 1-256, but rather the BLU link input channels that have been assigned to amplifier input slots A-H..
- **Digital with Analog Backup:** The input takes the digital signal as its source when the digital signal or just the digital clock is present. If the digital lock is lost, the input switches to the selected Analog Source. Once that digital lock is found again, the input switches back to the selected digital source. This works even when the digital signal has no audio but is sending a clock signal.
- **Analog Overrides:** BLU link input takes the digital signal as its source. If the analog signal level is greater than an Analog Signal Threshold that the user defines, the input switches to the analog signal. As long as the analog signal level exceeds the threshold, or as long as its level falls below threshold for a user-defined hold time, the input remains the analog signal

The control operation will vary based on the mode that is selected.

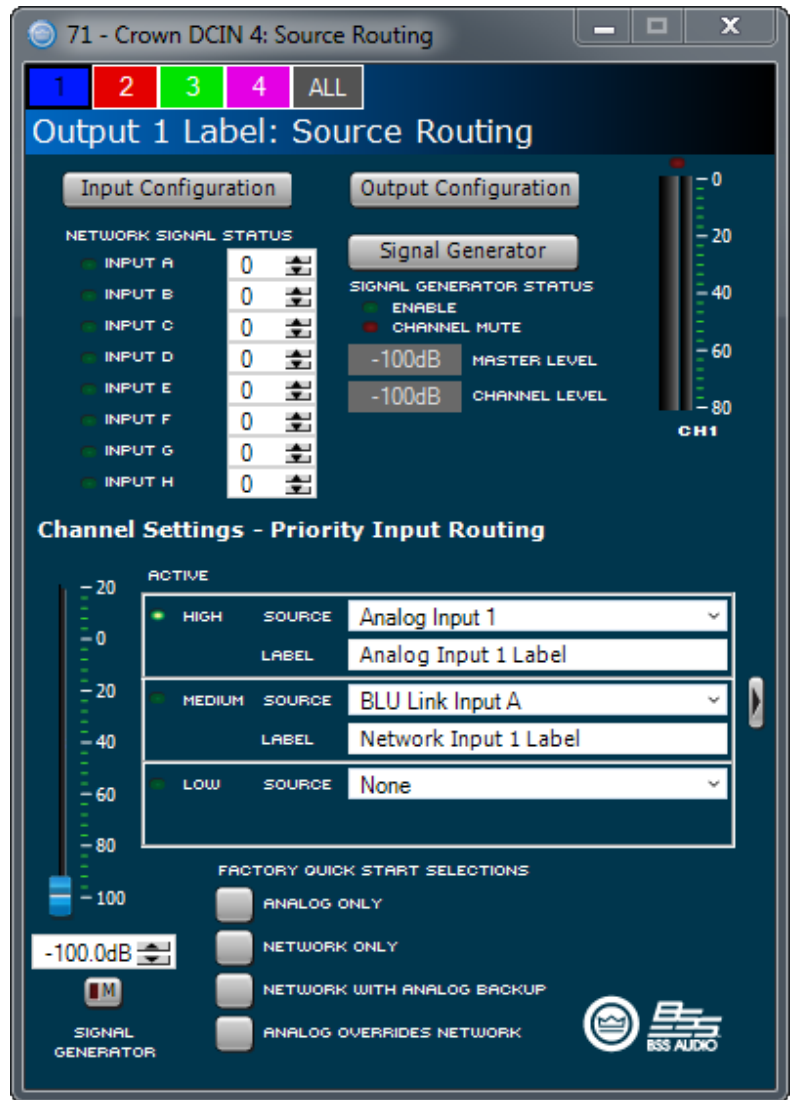

Figure 38

# Advanced Operation

## Source Routing/Configuration

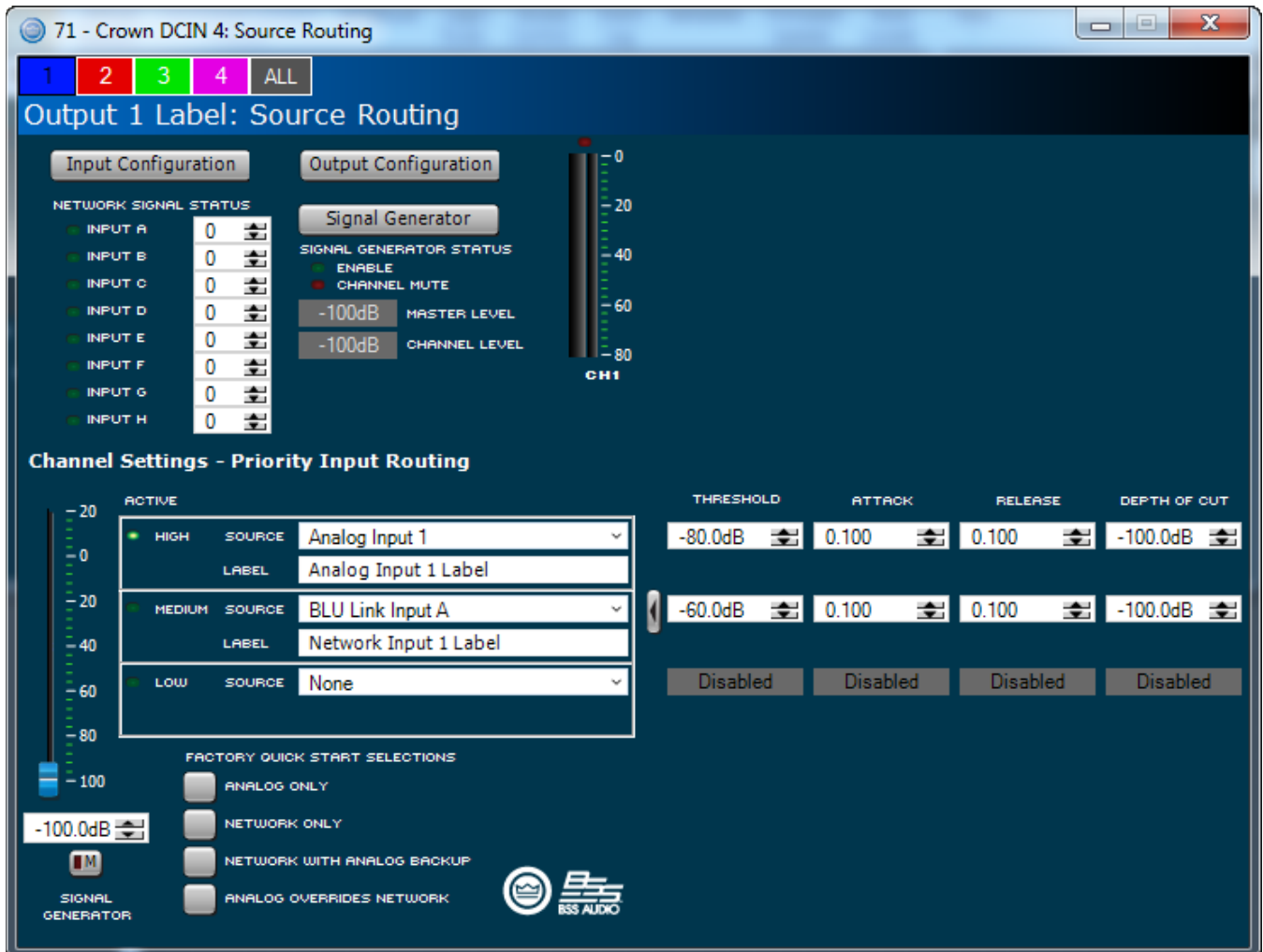

Figure 39

Quick Start Selection button at the bottom of the page. Manual configuration of Threshold, Attack, Release, and Depth of Cut can be adjusted in this page. These items are defined as follows:

- Threshold – Sets the level in dB below which the secondary input will be engaged.
- Attack – Defined as the time it takes for the secondary source to engage. This can range from 0.1 seconds to 1.0 seconds
- Release – Defined as the time it takes for the primary input to re-engage one the threshold level is exceeded.
- Depth of Cut – Defined as the level in dB of the primary source is held at if the release time is not exceeded.

Analog Only: This is the audio input from the audio connector on the back panel of the amp. Choices for the Analog Audio input are Channel 1, Channel 2, or a sum of Channels 1 and 2.

# Advanced Operation

## Input Delay and Driver/Output Delay

Input delay includes up to 2 seconds of delay. Output delay is typically used for driver alignment. Up to 0.1 seconds of output delay is provided. See Figure 40

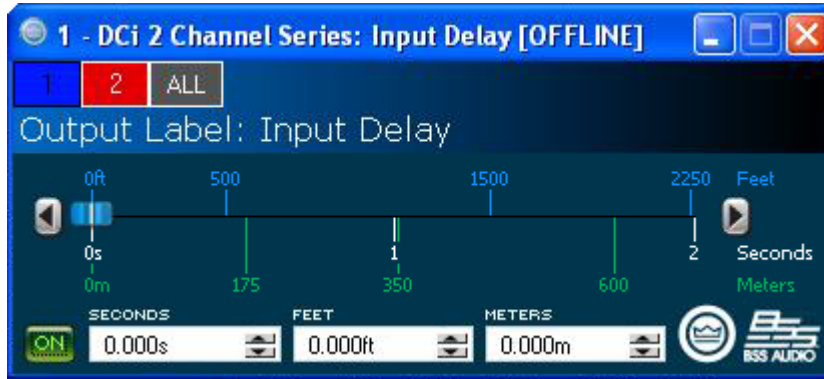

Figure 40

## Input/Output Equalization

These screens let you adjust channel equalization for up to 8 frequencies. You can select filter type, frequency, gain, and bandwidth in octaves or Q as set by the user preferences in Audio Architect. Changes to the equalizer's frequency response can be done by typing in parameters or by click-dragging the response curve. See Figure 41.



Figure 41



# Advanced Operation

## Crossover Filters

The Crossover section lets you use infinite impulse response (IIR) Crossover filter.

Each audio channel has three separate places where filters can be placed in the system: input EQ, Crossover, and Output EQ. Up to 16 EQ filters per channel are available, plus crossover filters. Each filter has up to +/-24dB of gain. The following filters are available:

- Lowpass & Highpass:
  - Bessel 12dB/oct, 18dB/oct, 24dB/oct, 30dB/oct, 36dB/oct, 42dB/oct, 48dB/oct
  - Butterworth 12dB/oct, 18dB/oct, 24dB/oct, 30dB/oct, 36dB/oct, 42dB/oct, 48dB/oct
  - Linkwitz-Riley 24dB/oct, 36dB/oct, 48dB/oct
- Lowshelf: Low-frequency shelving EQ
- Highshelf: High-frequency shelving EQ
- Lowpass EQ: Variable bandwidth, can be expressed as Q (0.100 to 35) or Octaves (0.041 to 6.672)
- Highpass EQ: Variable Q from 0.1 to 25
- Parametric EQ: Variable Q from 0.1 to 35

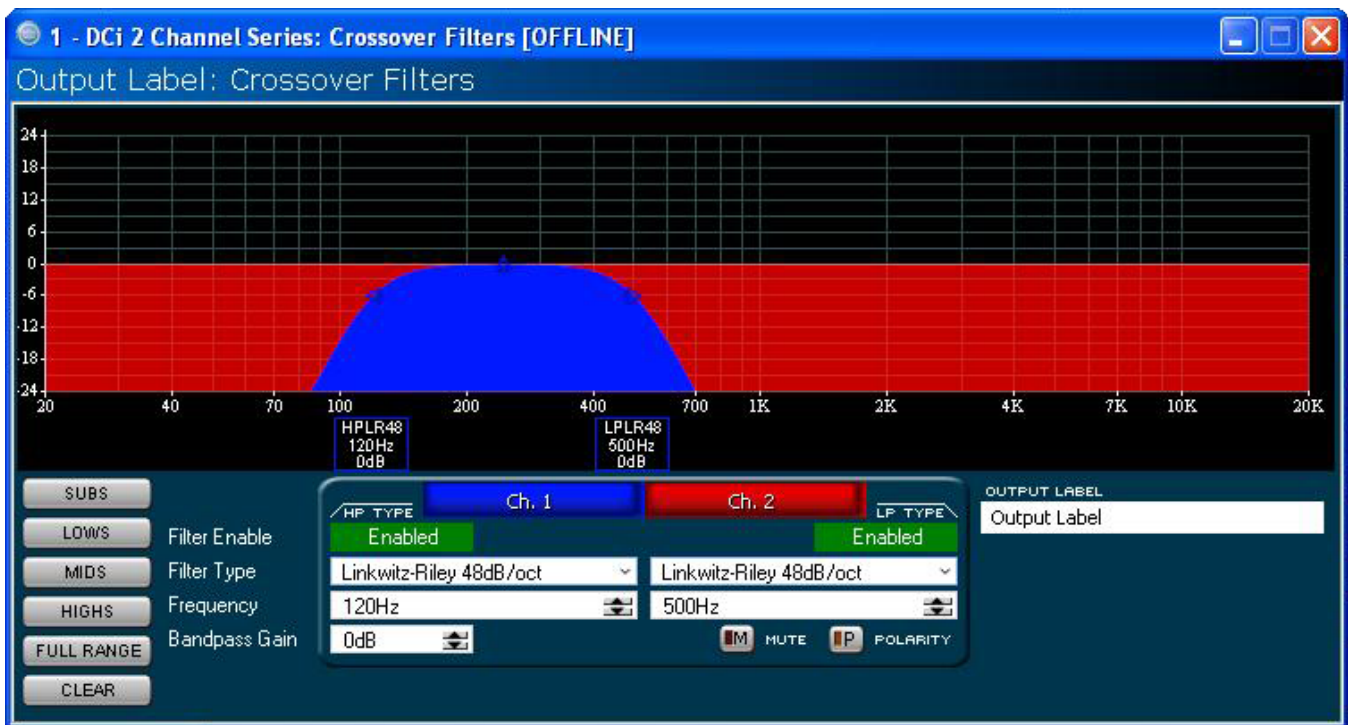

Figure 42



# Advanced Operation

## LevelMax™ Suite

This is a suite consisting of a peak voltage limiter, RMS power limiter, clip limiter and transducer thermal limiter. First you will set the mode to automatic or advanced: See Figure 43.

- Automatic mode: The software determines the best settings based on the signal characteristics. You can modify only the RMS threshold, Speaker Thermal threshold and time constant. Everything else is set automatically.
- Advanced mode: You can modify the RMS threshold, Speaker Thermal threshold, time constant, Peak threshold and Peak/RMS release. Peak Voltage Limiter This limits the peak voltage output of the amplifier.
- On: Enables or disables this function. You'll set the parameters below:
- Threshold: Sets the level, in absolute voltage, which the limiter will allow from the amplifier. The range is from 1 Vpk to 255 Vpk.
- Attack Time: Sets the attack time of the limiter. The attack time is defined as the time it takes the limiter to attenuate the output signal by 20 dB. The range is from .1 millisecond to 100 milliseconds. The Instant setting attack time is instant (0 millisecond).
- Release Time: Sets the release time of the compressor. The release time is defined as the time it takes the limiter to increase the output signal by 20 dB. The range is the same range as attack time above.

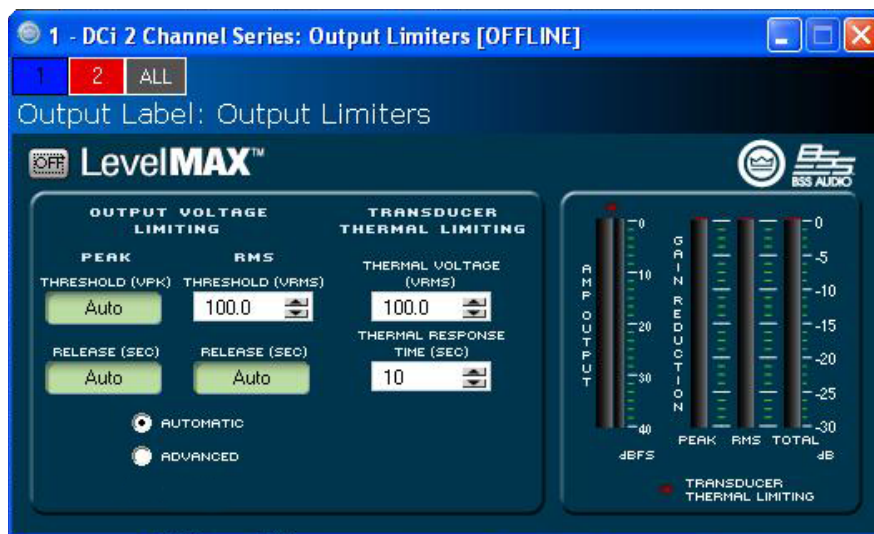

Figure 43

## Transducer Thermal Limiter

This limits the long-term output power of the amplifier to what the loudspeaker load can handle without overheating and going into thermal compression. You can set the voltage level at which the thermal limiter engages, the thermal response time and thermal voltage. Your loudspeaker manufacturer might be able to provide this information.

Meters show the amplifier output level in dBFS; and peak, RMS, and total gain reduction.

# Signal Path

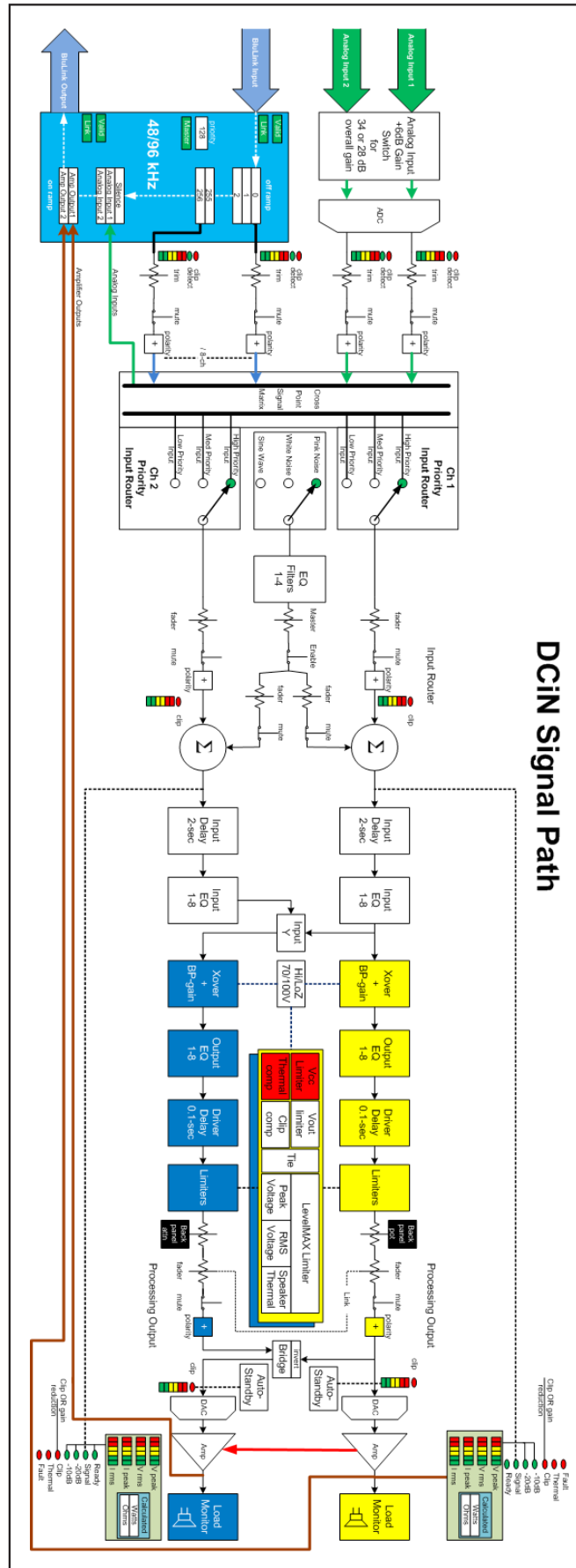

Figure 44 Signal Path

# Per Channel Settings

## Channel Attenuators

Each channel is supplied with a logarithmic 21-position detented input attenuator. Use a flat-blade screwdriver to set input level. Attenuation is from -95 dB (full counter-clockwise) to 0 dB (full clockwise). For gain structure purposes, it is important to note that attenuators are at the end of the DSP signal chain.

Position	0	1	2	3	4	5	6	7	8	9	10
Typical Attenuation	0	-0.1	-1	-2	-3	-4	-5	-6	-7	-8	-9

Position	11	12	13	14	15	16	17	18	19	20
Typical Attenuation	-10	-13	-16	-20	-30	-40	-50	-60	Mute	Mute

# Protection System

---

## Thermal Indicator

If the amplifier becomes too hot for safe operation, the channel that is generating too much heat will be shut down until the temperature drops below the thermal limit. The front-panel thermal indicator will illuminate at 80 degrees Celsius, indicating the onset of compression affecting the audio signal. The amplifier will continue to run in this state until either the temperature is reduced to a safe operating range, or if the temperature continues to rise, the channel will shut off to protect itself above 98 degrees Celsius.

---

## Fault

The amplifier will enter a Fault state if the amplifier senses an unsafe condition. This protection is for both internal and external faults. In addition, be sure that the load connected to the amplifier is within 2 - 16 Ohm limit (4 - 16 Ohm Bridge Mono). If wiring is verified as correct and the fault condition persists, see Page 63 for servicing information.

---

## Auto Insertion High-Pass Filters

A 35 Hz high-pass filter is inserted automatically when a channel is selected for Hi-Z operation.

---

## AC Under/Over Voltage Protection

If the AC line voltage drops below 10% or rises above 10% of the nominal operating voltage of the amplifier, the amplifier's power supply turns off and the blue Power LED flashes. The amplifier will turn back on when the AC line voltage returns to safe operating levels.

---

## Fuse

A fuse (F1) located near the IEC power inlet protects the amplifier from excessive AC current draw. The DCi2|2400N, 4|1250N, 4|2400N, and 8|600N models utilizes a resettable breaker instead of a fuse.. Please contact Crown Service department for more information.

---

## Fan-cooled Chassis

DCi Series amplifiers are cooled by quiet, variable speed fans. Maximum fan noise level of a DCi amplifier is 47 dBA.. The fans will pull air from the front of the amplifier to the rear of the amplifier.

The following fault conditions cause the fan to turn on full speed.

- High Frequency fault
- DC fault
- Short circuit fault
- Thermal fault
- Rail fault
- After a fault, the fan will remain at full speed for at least 60sec

---

## Universal Switching Power Supply

The DCi Series incorporates a new switching power supply designed for extremely high efficiency and high output power. The supply includes Power Factor Correction (PFC), a Series Resonant Converter (SRC) and accepts AC supply voltages from 100 V~ to 240 V~. Microprocessor controlled diagnostic and control capabilities both optimize performance, and enhance long-term reliability.

# Troubleshooting

Fault	●		
Thermal	●		
Clip	●		
-10	●		
-20	●		
Signal	●	Power	●
Ready	●	Data	●

**CONDITION: Power indicator is off. Mains indicator is on.**

**POSSIBLE REASON**

- The amplifier's Power switch is off.

**Key**

- Off
- ◐ Flashing
- Off/Flashing/On
- ☀ Lit

"Off/Flashing/On" above means that the LED can be off, or flashing, or on.

Fault	●		
Thermal	●		
Clip	●		
-10	●		
-20	●		
Signal	●	Power	●
Ready	●	Data	●

**CONDITION: Power indicator is off. Mains indicator is off.**

**POSSIBLE REASON**

- The power supply fuse has tripped.
- The amplifier has lost AC Power.
- The amplifier is not plugged in to the power receptacle.

Fault	●		
Thermal	●		
Clip	●		
-10	●		
-20	●		
Signal	●	Power	◐
Ready	●	Data	●

**CONDITION: Power indicator is flashing.**

**POSSIBLE REASON:**

- The AC line voltage has dropped below 10% or has risen above 10% of the nominal line voltage of the power supply.
- When the Amp is in Sleep Mode as set by the AUX Port, the amplifier will not power up until the ground closure on the AUX Port is released. When the power button is pushed in this condition, the Power Indicator will flash for 2 – 3 seconds.

Fault	●		
Thermal	☀		
Clip	●		
-10	●		
-20	●		
Signal	●	Power	☀
Ready	●	Data	○

**CONDITION: Thermal indicator is on.**

**POSSIBLE REASON:**

- The amplifier is becoming too hot for safe operation. Allow amplifier to cool. Check for loads less than 2Ω, and for excessive input levels. Check for proper ventilation and proper mode-switch setting.

Fault	◐		
Thermal	●		
Clip	●		
-10	●		
-20	●		
Signal	●	Power	☀
Ready	●	Data	●

**CONDITION: Fault indicator is flashing.**

**POSSIBLE REASON:**

- There are a number of conditions that result in the Fault indicator flashing: temperature above 98C, DC/LF protection is engaged, HF detect, output short circuit detected. These conditions should all be checked and attempted to be resolved before the amp is shipped back for service.

# Troubleshooting

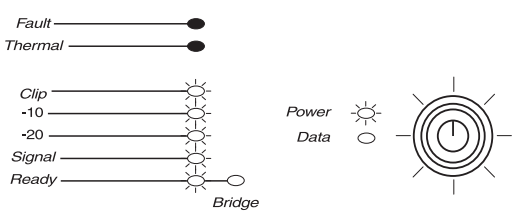

**CONDITION: Distorted sound.**

**POSSIBLE REASON:**

- Load is wired incorrectly or Stereo/Bridge mode switch is set incorrectly. Check both.
- Input is overloaded by a signal level that is too high. Turn down your amplifier level controls, or turn down the input signal, until the clip light goes out.

**Note:** If the signal sounds distorted even though the Clip LED is off, the input signal may be distorted before it reaches the amplifier input. Check gain staging and output levels of the mixer or preamp.

**Key**

- Off
- ◐ Flashing
- Off/Flashing/On
- ☀ Lit

"Off/Flashing/On" above means that the LED can be off, or flashing, or on.

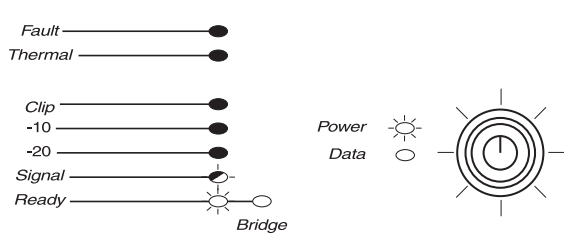

**CONDITION: No sound, even though the amp has power.** Power LED is on without flashing and the amp is receiving an input signal. Signal indicator is flashing.

**POSSIBLE REASON:**

- Speakers not connected.
- Open circuit due to speaker failure.

---

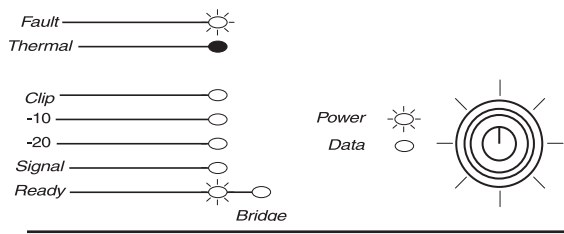

Based on the front panel LEDs, determine which channel has a short. Remove the associated input connector to ensure that no voltage will be present on the output. Remove the shorted load (and possibly attached cables) and have it checked by a qualified technician. If the shorted condition remains after the load is removed, the unit should be sent into a qualified service center.

---

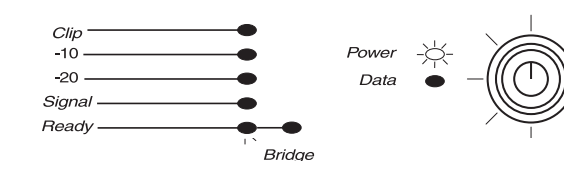

- Ready LED is off. Channel has been set to Sleep mode via the Aux port or Power Save mode.

# Troubleshooting

**CONDITION: No input signal.**  
Signal indicator is not flashing even though audio is applied, and the channel is ready..

**POSSIBLE REASON:**

- Input signal level is very low.

**Key**

- Off
- ◐ Flashing
- Off/Flashing/On
- ☀ Lit

“Off/Flashing/On” above means that the LED can be off, or flashing, or on.

**CONDITION: Bridge LED is lit.**

**POSSIBLE REASON:**

- Amplifier is in Bridge Mono mode.

# DCi Specifications

## Dual-Mode - All Channels Driven

DCi Network Model	Channels	2Ω	4Ω	8Ω	16Ω	70Vrms	100Vrms
2 300N	2	150W	300W	300W	150W	300W	300W
2 600N	2	300W	600W	600W	300W	600W	600W
4 300N	4	150W	300W	300W	150W	300W	300W
4 600N	4	300W	600W	600W	300W	600W	600W
8 300N	8	150W	300W	300W	150W	300W	300W
8 600N	8	300W	600W	600W	300W	600W	600W
2 1250N	2	1250W	1250W	1250W	625W	1250W	1250W
4 1250N	4	1250W	1250W	1250W	625W	1250W	1250W
2 2400N	2	2100W	2400W	1900W	950W	2100W	2300W
4 2400N	4	2100W	2400W	1900W	950W	2100W	2300W

Minimum Guaranteed Power (20 Hz - 20 kHz)



# DCi Specifications

## Bridge Mono Mode - All Channels Driven

DCi Network Model	4Ω	8Ω	16Ω	140Vrms	200Vrms
2I300N	300W	600W	600W	600W	600W
2I600N	600W	1200W	1200W	1200W	1200W
4I300N	300W	600W	600W	600W	600W
4I600N	600W	1200W	1200W	1200W	1200W
8I300N	300W	600W	600W	600W	600W
8I600N	600W	1200W	1200W	1200W	1200W
2I1250N	2500W	2500W	2500W	2500W	2500W
4I1250N	2500W	2500W	2500W	2500W	2500W
2I2400N	4200W	4800W	3800W	4200W	4600W
4I2400N	4200W	4800W	3800W	4200W	4600W

Minimum Guaranteed Power (20 Hz - 20 kHz)

## Input Sensitivity

DCi Network Model	8Ω	70Vrms	100Vrms
2I300N	1.0Vrms	1.4Vrms	2.0Vrms
2I600N	1.4Vrms	1.4Vrms	2.0Vrms
4I300N	1.0Vrms	1.4Vrms	2.0Vrms
4I600N	1.4Vrms	1.4Vrms	2.0Vrms
8I300N	1.0Vrms	1.4Vrms	2.0Vrms
8I600N	1.4Vrms	1.4Vrms	2.0Vrms
2I1250N	2.0Vrms	1.4Vrms	2.0Vrms
4I1250N	2.0Vrms	1.4Vrms	2.0Vrms
2I2400N	2.5Vrms	1.4Vrms	2.0Vrms
4I2400N	2.5Vrms	1.4Vrms	2.0Vrms

## Dimensions

DCi Network Model	Width	Height	Depth
2I300N	19 in. (48.3 cm)	3.5 in. (8.9 cm)	14.25 in. (36.2 cm)
2I600N	19 in. (48.3 cm)	3.5 in. (8.9 cm)	14.25 in. (36.2 cm)
4I300N	19 in. (48.3 cm)	3.5 in. (8.9 cm)	14.25 in. (36.2 cm)
4I600N	19 in. (48.3 cm)	3.5 in. (8.9 cm)	14.25 in. (36.2 cm)
8I300N	19 in. (48.3 cm)	3.5 in. (8.9 cm)	14.25 in. (36.2 cm)
8I600N	19 in. (48.3 cm)	3.5 in. (8.9 cm)	17 in. (43.2 cm)
2I1250N	19 in. (48.3 cm)	3.5 in. (8.9 cm)	14.25 in. (36.2 cm)
4I1250N	19 in. (48.3 cm)	3.5 in. (8.9 cm)	17 in. (43.2 cm)
2I2400N	19 in. (48.3 cm)	3.5 in. (8.9 cm)	19 in. (48.3 cm)
4I2400N	19 in. (48.3 cm)	3.5 in. (8.9 cm)	19 in. (48.3 cm)

# DCi Specifications

## Performance Specifications

	2 300N	2 600N	4 300N	4 600N	8 300N	8 600N	2 1250N	4 1250N	2 2400N	4 2400N
Voltage Gain (at maximum level setting) 4/8Ω, 70Vrms and 100Vrms Operation	34dB									
Frequency Response (8Ω, 20Hz - 20kHz)	±0.25dB									
BLU link Signal-to-Noise Ratio (ref. rated power, 8Ω, 20Hz - 20kHz)	>108dB									
Total Harmonic Distortion (at full rated power, from 20Hz - 20kHz)	0.35%									
Analog Input Signal to Noise Ratio (ref. rated power, 8Ω, 20Hz - 20kHz)	>104dB									
Intermodulation Distortion (60Hz and 7kHz at 4:1, from - 30dB to full rated power)	≤0.35%									
Damping Factor (20Hz to 100Hz)	>1000	>1000	>1000	>1000	>1000	>1000	>1500	>1500	>5000	
Crosstalk (below rated power, 20Hz to 1kHz)	>80dB									
Common Mode Rejection (20Hz to 1kHz, typical)	>70dB									
DC Output Offset (with inputs shorted)	±10mV									
Input Impedance (Nominally balanced, nominally unbalanced)	10 kΩ, 5 kΩ									
Maximum Input Level (Low Gain Mode)	+20dBu									
Required AC Mains (±10%)	100Vrms - 240Vrms~ 50/60Hz									
Cooling	Continuously variable speed forced air, front-to-back airflow									
Power Supply Connector	15A IEC Connector; 8 600N, 4 1250N, and 2 2400 utilize a 20A IEC connector. 4 2400 utilizes a 32A PowerCon® AC inlet, 100-240V.®									
Load Impedance Stereo/Dual Mode	2Ω - 16Ω; 70Vrms and 100Vrms									
Load Impedance Bridge Mono	4Ω - 16Ω; 140Vrms and 200Vrms									
Maximum Fan Noise (re dB SPL @ 1M)	45	45	45	45	47	47	47	47	–	–
Weight	18.8 lbs (8.53 kg)	18.8 lbs (8.53 kg)	20.1 lbs (9.12 kg)	20.1 lbs (9.12 kg)	23.5 lbs (10.66 kg)	30 lbs (13.60 kg)	20.1 lbs (9.12 kg)	30 lbs (13.60 kg)	24 lbs (10.9 kg)	29.7 lbs (13.5 kg)

# AC Power Draw and Thermal Dissipation

## AC Power Draw and Thermal Dissipation:

Pink noise 12dB crest factor, bandwidth limited 22Hz to 22kHz.

Typical line impedance used.

Data based on all channels driven.

DCi 2I300N - Bridge									
		120 VAC / 60 Hz				230 VAC / 50 Hz			
Condition	Load	"Line current (amps)"	Power Dissipated as Heat			"Line current (amps)"	Power Dissipated as Heat		
			watts	BTU	kcal/hr		watts	BTU	kcal/hr
At Idle Awake	N/A	0.6	67	229	58	0.4	68	231	58
<b>1/8 Power Pink Noise</b> Typical of program material just at clip	4Ω	1.1	86	293	74	0.6	83	284	72
	8Ω	1.4	88	300	76	0.8	86	293	74
	16Ω	1.4	83	282	71	0.7	78	267	67
	140V (32.67Ω)	1.3	78	265	67	0.7	74	252	64
	200V (66.67Ω)	1.3	76	260	66	0.7	72	246	62
<b>1/3 Power Pink Noise</b> Typical of program material at extreme clip	4Ω	1.9	108	370	93	1.0	105	357	90
	8Ω	2.7	113	387	98	1.4	106	363	92
	16Ω	2.7	99	339	85	1.3	89	305	77
	140V (32.67Ω)	2.4	86	295	74	1.3	82	280	70
	200V (66.67Ω)	2.5	87	295	74	1.3	80	273	69

DCi 2I300N - Dual									
		120 VAC / 60 Hz				230 VAC / 50 Hz			
Condition	Load	"Line current (amps)"	Power Dissipated as Heat			"Line current (amps)"	Power Dissipated as Heat		
			watts	BTU	kcal/hr		watts	BTU	kcal/hr
At Idle Awake	N/A	0.6	70	240	60	0.4	68	231	58
<b>1/8 Power Pink Noise</b> Typical of program material just at clip	2Ω	1.1	85	291	73	0.6	83	284	72
	4Ω	1.4	89	304	77	0.8	85	289	73
	8Ω	1.4	83	282	71	0.7	79	269	68
	70V (16.33Ω)	1.3	78	265	67	0.7	75	256	65
	100V (33.33Ω)	1.3	77	263	66	0.7	73	248	63
<b>1/3 Power Pink Noise</b> Typical of program material at extreme clip	2Ω	1.9	109	373	94	1.0	104	356	90
	4Ω	2.7	113	387	98	1.4	105	359	90
	8Ω	2.5	99	339	85	1.3	93	316	80
	70V (16.33Ω)	2.5	89	304	77	1.3	82	279	70
	100V (33.33Ω)	2.5	82	280	70	1.3	81	276	69

# AC Power Draw and Thermal Dissipation

## AC Power Draw and Thermal Dissipation:

Pink noise 12dB crest factor, bandwidth limited 22Hz to 22kHz.

Typical line impedance used.

Data based on all channels driven.

DCi 2 600N - Bridge									
		120 VAC / 60 Hz				230 VAC / 50 Hz			
Condition	Load	"Line current (amps)"	Power Dissipated as Heat			"Line current (amps)"	Power Dissipated as Heat		
			watts	BTU	kcal/hr		watts	BTU	kcal/hr
At Idle Awake	N/A	0.6	71	241	61	0.4	66	226	57
<b>1/8 Power Pink Noise</b> Typical of program material just at clip	4Ω	1.4	90	308	78	0.8	91	311	78
	8Ω	2.2	101	344	87	1.2	101	344	87
	16Ω	2.1	94	321	81	1.1	92	314	79
	140Vrms (16Ω)	2.1	93	318	80	1.1	91	312	79
	200Vrms (33.33Ω)	2.0	86	295	74	1.1	84	287	72
<b>1/3 Power Pink Noise</b> Typical of program material at extreme clip	4Ω	2.8	128	438	110	1.6	133	453	114
	8Ω	4.8	157	536	135	2.5	148	505	127
	16Ω	4.6	130	444	112	2.3	118	403	102
	140V (16Ω)	4.6	125	427	108	2.3	117	399	101
	200V (33.33Ω)	4.4	106	363	91	2.3	105	358	90

DCi 2 600N - Dual									
		120 VAC / 60 Hz				230 VAC / 50 Hz			
Condition	Load	"Line current (amps)"	Power Dissipated as Heat			"Line current (amps)"	Power Dissipated as Heat		
			watts	BTU	kcal/hr		watts	BTU	kcal/hr
At Idle Awake	N/A	0.6	70	240	60	0.4	71	241	61
<b>1/8 Power Pink Noise</b> Typical of program material just at clip	2Ω	1.6	102	348	88	0.9	93	319	80
	4Ω	2.3	107	364	92	1.2	104	355	89
	8Ω	2.2	98	333	84	1.2	96	328	83
	70V (8Ω)	2.2	96	329	83	1.2	94	322	81
	100V (16.67Ω)	2.0	87	297	75	1.1	87	298	75
<b>1/3 Power Pink Noise</b> Typical of program material at extreme clip	2Ω	3.0	142	486	122	1.6	134	456	115
	4Ω	4.8	161	549	139	2.5	153	521	131
	8Ω	4.5	131	446	112	2.4	129	441	111
	70V (8Ω)	4.5	130	442	111	2.3	122	417	105
	100V (16.67Ω)	4.5	122	417	105	2.4	109	370	93

# AC Power Draw and Thermal Dissipation

## AC Power Draw and Thermal Dissipation:

Pink noise 12dB crest factor, bandwidth limited 22Hz to 22kHz.

Typical line impedance used.

Data based on all channels driven.

DCi 2 1250N - Bridge									
		120 VAC / 60 Hz				230 VAC / 50 Hz			
Condition	Load	"Line current (amps)"	Power Dissipated as Heat			"Line current (amps)"	Power Dissipated as Heat		
			watts	BTU	kcal/hr		watts	BTU	kcal/hr
At Idle Awake	N/A	0.8	101	345	87	0.5	100	340	86
<b>1/8 Power Pink Noise</b> Typical of program material just at clip	4Ω	4.1	151	514	130	2.2	150	511	129
	8Ω	3.9	127	435	110	2.0	116	395	100
	16Ω	3.8	115	393	99	1.9	106	361	91
	140V (8Ω)	4.2	162	552	139	2.1	126	431	109
	200V (16Ω)	3.9	142	485	122	2.0	118	401	101
<b>1/3 Power Pink Noise</b> Typical of program material at extreme clip	4Ω	9.9	279	951	240	4.9	259	883	223
	8Ω	9.2	238	812	205	4.8	206	703	177
	16Ω	9.2	233	797	201	4.7	193	660	166
	140V (8Ω)	8.7	224	765	193	4.6	188	641	162
	200V (16Ω)	9.4	233	797	201	4.5	183	626	158

DCi 2 1250N - Dual									
		120 VAC / 60 Hz				230 VAC / 50 Hz			
Condition	Load	"Line current (amps)"	Power Dissipated as Heat			"Line current (amps)"	Power Dissipated as Heat		
			watts	BTU	kcal/hr		watts	BTU	kcal/hr
At Idle Awake	N/A	0.8	101	345	87	0.5	99	338	85
<b>1/8 Power Pink Noise</b> Typical of program material just at clip	2Ω	5.0	171	584	147	2.7	156	532	134
	4Ω	4.6	155	530	134	2.4	142	486	123
	8Ω	4.2	136	465	117	2.0	108	369	93
	70V (4Ω)	4.6	131	447	113	2.3	108	369	93
	100V (8Ω)	4.4	120	410	103	2.1	111	380	96
<b>1/3 Power Pink Noise</b> Typical of program material at extreme clip	2Ω	10.1	261	890	224	5.3	255	871	220
	4Ω	10.0	229	780	197	4.8	210	717	181
	8Ω	9.1	176	602	152	4.7	203	694	175
	70V (4Ω)	9.8	210	715	180	4.9	176	602	152
	100V (8Ω)	9.1	174	593	150	4.6	165	562	142

# AC Power Draw and Thermal Dissipation

## AC Power Draw and Thermal Dissipation:

Pink noise 12dB crest factor, bandwidth limited 22Hz to 22kHz.

Typical line impedance used.

Data based on all channels driven.

DCi 2 2400N - Bridge									
		120 VAC / 60 Hz				230 VAC / 50 Hz			
Condition	Load	"Line current (amps)"	Power Dissipated as Heat			"Line current (amps)"	Power Dissipated as Heat		
			watts	BTU	kcal/hr		watts	BTU	kcal/hr
At Idle Awake	N/A	1.8	179	612	154	1.6	201	685	173
<b>1/8 Power Pink Noise</b> Typical of program material just at clip	4Ω	10.7	523	1785	450	6.4	545	1859	469
	8Ω	7.3	353	1204	304	4.3	367	1252	316
	16Ω	4.5	239	817	206	2.8	260	888	224
	140V (32.67Ω)	8.3	401	1367	345	4.9	433	1477	372
	200V (66.67Ω)	8.3	362	1237	312	5.0	384	1310	330
<b>1/3 Power Pink Noise</b> Typical of program material at extreme clip	4Ω	23.6	881	3007	758	12.2	979	3341	842
	8Ω	16.9	611	2085	526	9.3	568	1939	489
	16Ω	9.2	286	975	246	5.0	331	1130	285
	140V (32.67Ω)	18.2	688	2348	592	10.0	657	2243	565
	200V (66.67Ω)	18.8	573	1954	493	10.5	584	1994	503

DCi 2 2400N - Dual									
		120 VAC / 60 Hz				230 VAC / 50 Hz			
Condition	Load	"Line current (amps)"	Power Dissipated as Heat			"Line current (amps)"	Power Dissipated as Heat		
			watts	BTU	kcal/hr		watts	BTU	kcal/hr
At Idle Awake	N/A	1.8	179	612	154	1.6	201	685	173
<b>1/8 Power Pink Noise</b> Typical of program material just at clip	2Ω	10.7	523	1785	450	6.4	545	1859	469
	4Ω	7.3	353	1204	304	4.3	367	1252	316
	8Ω	4.5	239	817	206	2.8	260	888	224
	70V (16.33Ω)	8.3	401	1367	345	4.9	433	1477	372
	100V (33.33Ω)	8.3	362	1237	312	5.0	384	1310	330
<b>1/3 Power Pink Noise</b> Typical of program material at extreme clip	2Ω	23.6	881	3007	758	12.2	979	3341	842
	4Ω	16.9	611	2085	526	9.3	568	1939	489
	8Ω	9.2	286	975	246	5.0	331	1130	285
	70V (16.33Ω)	18.2	688	2348	592	10.0	657	2243	565
	100V (33.33Ω)	18.8	573	1954	493	10.5	584	1994	503

# AC Power Draw and Thermal Dissipation

## AC Power Draw and Thermal Dissipation:

Pink noise 12dB crest factor, bandwidth limited 22Hz to 22kHz.

Typical line impedance used.

Data based on all channels driven.

DCi 4 300N - Bridge									
P1-32		120 VAC / 60 Hz				230 VAC / 50 Hz			
Condition	Load	"Line current (amps)"	Power Dissipated as Heat			"Line current (amps)"	Power Dissipated as Heat		
			watts	BTU	kcal/hr		watts	BTU	kcal/hr
At Idle Awake	N/A	1.0	118	402	101	0.6	118	401	101
<b>1/8 Power Pink Noise</b> Typical of program material just at clip	4Ω	1.9	152	520	131	1.0	148	505	127
	8Ω	2.5	152	517	130	1.3	151	515	130
	16Ω	2.5	141	480	121	1.3	136	464	117
	140V (32.67Ω)	2.5	133	453	114	1.3	131	446	113
	200V (66.67Ω)	2.4	128	435	110	1.2	126	430	108
<b>1/3 Power Pink Noise</b> Typical of program material at extreme clip	4Ω	3.2	190	650	164	1.7	185	630	159
	8Ω	5.2	205	699	176	2.6	194	664	167
	16Ω	4.9	171	583	147	2.5	168	575	145
	140V (32.67Ω)	4.7	157	535	135	2.4	153	523	132
	200V (66.67Ω)	4.8	148	507	128	2.5	146	498	125

DCi 4 300N - Dual									
P1-32		120 VAC / 60 Hz				230 VAC / 50 Hz			
Condition	Load	"Line current (amps)"	Power Dissipated as Heat			"Line current (amps)"	Power Dissipated as Heat		
			watts	BTU	kcal/hr		watts	BTU	kcal/hr
At Idle Awake	N/A	1.0	119	407	103	0.6	114	389	98
<b>1/8 Power Pink Noise</b> Typical of program material just at clip	2Ω	2.0	153	523	132	1.0	140	478	120
	4Ω	2.6	155	528	133	1.4	146	498	125
	8Ω	2.4	136	463	117	1.3	135	460	116
	70V (16.33Ω)	2.5	135	459	116	1.3	127	433	109
	100V (33.33Ω)	2.4	129	440	111	1.3	121	414	104
<b>1/3 Power Pink Noise</b> Typical of program material at extreme clip	2Ω	3.3	195	665	168	1.7	177	604	152
	4Ω	5.0	207	705	178	2.6	185	632	159
	8Ω	4.8	178	609	154	2.5	159	544	137
	70V (16.33Ω)	4.7	155	530	134	2.4	148	505	127
	100V (33.33Ω)	4.7	150	514	129	2.5	142	486	122



# AC Power Draw and Thermal Dissipation

## AC Power Draw and Thermal Dissipation:

Pink noise 12dB crest factor, bandwidth limited 22Hz to 22kHz.

Typical line impedance used.

Data based on all channels driven.

DCi 4 600N - Bridge									
P1-32		120 VAC / 60 Hz				230 VAC / 50 Hz			
Condition	Load	"Line current (amps)"	Power Dissipated as Heat			"Line current (amps)"	Power Dissipated as Heat		
			watts	BTU	kcal/hr		watts	BTU	kcal/hr
At Idle Awake	N/A	1.0	113	387	98	0.6	118	404	102
<b>1/8 Power Pink Noise</b> Typical of program material just at clip	4Ω	2.7	170	582	147	1.4	165	563	142
	8Ω	4.1	176	599	151	2.1	178	608	153
	16Ω	3.8	156	531	134	2.0	151	516	130
	140V (16Ω)	3.9	156	534	135	2.1	158	538	136
	200V (33.33Ω)	3.8	150	511	129	2.0	141	482	122
<b>1/3 Power Pink Noise</b> Typical of program material at extreme clip	4Ω	5.6	247	844	213	2.9	235	801	202
	8Ω	9.5	298	1018	257	4.8	269	916	231
	16Ω	8.7	223	760	192	4.5	207	705	178
	140V (16Ω)	8.7	230	786	198	4.5	214	730	184
	200V (33.33Ω)	8.7	203	692	174	4.4	176	601	151

DCi 4600N - Dual									
		120 VAC / 60 Hz				230 VAC / 50 Hz			
Condition	Load	"Line current (amps)"	Power Dissipated as Heat			"Line current (amps)"	Power Dissipated as Heat		
			watts	BTU	kcal/hr		watts	BTU	kcal/hr
At Idle Awake	N/A	1.0	113	386	97	0.6	115	391	99
<b>1/8 Power Pink Noise</b> Typical of program material just at clip	2Ω	2.8	172	588	148	1.5	162	555	140
	4Ω	4.1	165	564	142	2.1	171	582	147
	8Ω	3.9	151	514	130	2.0	138	470	119
	70V (16.33Ω)	3.9	147	500	126	2.1	143	488	123
	100V (33.33Ω)	3.7	138	470	118	2.0	134	458	115
<b>1/3 Power Pink Noise</b> Typical of program material at extreme clip	2Ω	5.9	256	874	220	3.1	253	862	217
	4Ω	9.0	264	900	227	4.5	234	799	201
	8Ω	8.6	213	726	183	4.5	206	704	178
	70V (16.33Ω)	8.8	223	760	192	4.5	200	682	172
	100V (33.33Ω)	8.5	196	670	169	4.4	190	648	163

# AC Power Draw and Thermal Dissipation

## AC Power Draw and Thermal Dissipation:

Pink noise 12dB crest factor, bandwidth limited 22Hz to 22kHz.

Typical line impedance used.

Data based on all channels driven.

DCi 4 1250N - Bridge									
P1-32		120 VAC / 60 Hz				230 VAC / 50 Hz			
Condition	Load	"Line current (amps)"	Power Dissipated as Heat			"Line current (amps)"	Power Dissipated as Heat		
			watts	BTU	kcal/hr		watts	BTU	kcal/hr
At Idle Awake	N/A	1.6	183	625	157	0.9	183	625	157
<b>1/8 Power Pink Noise</b> Typical of program material just at clip	4Ω	8.4	309	1054	266	4.3	238	813	205
	8Ω	8.0	263	898	226	3.8	207	707	178
	16Ω	7.4	232	792	200	3.8	216	737	186
	140V (8Ω)	7.3	227	775	195	4.3	230	785	198
	200V (16Ω)	7.6	226	773	195	3.9	229	781	197
<b>1/3 Power Pink Noise</b> Typical of program material at extreme clip	4Ω	19.5	533	1819	458	10.0	419	1432	361
	8Ω	17.5	384	1311	330	9.5	414	1412	356
	16Ω	17.5	365	1246	314	9.0	292	997	251
	140V (8Ω)	16.8	330	1128	284	8.8	345	1176	296
	200V (16Ω)	17.1	334	1139	287	9.0	291	991	250

DCi 4 1250N - Dual									
P1-32		120 VAC / 60 Hz				230 VAC / 50 Hz			
Condition	Load	"Line current (amps)"	Power Dissipated as Heat			"Line current (amps)"	Power Dissipated as Heat		
			watts	BTU	kcal/hr		watts	BTU	kcal/hr
At Idle Awake	N/A	1.6	183	625	157	0.9	184	628	158
<b>1/8 Power Pink Noise</b> Typical of program material just at clip	2Ω	8.9	217	740	187	4.5	230	787	198
	4Ω	9.0	245	835	210	4.3	215	734	185
	8Ω	8.3	232	792	200	3.9	195	665	168
	70V (4Ω)	8.5	220	751	189	4.4	198	675	170
	100V (8Ω)	7.6	219	747	188	3.9	177	604	152
<b>1/3 Power Pink Noise</b> Typical of program material at extreme clip	2Ω	21.3	443	1512	381	10.6	405	1382	348
	4Ω	20.3	397	1357	342	9.3	300	1025	258
	8Ω	18.0	301	1027	259	8.8	249	851	215
	70V (4Ω)	17.1	289	988	249	9.0	262	896	226
	100V (8Ω)	17.4	278	950	240	9.1	265	904	228

# AC Power Draw and Thermal Dissipation

## AC Power Draw and Thermal Dissipation:

Pink noise 12dB crest factor, bandwidth limited 22Hz to 22kHz.

Typical line impedance used.

Data based on all channels driven.

DCi 4 2400N - Bridge									
P1-32		120 VAC / 60 Hz				230 VAC / 50 Hz			
Condition	Load	"Line current (amps)"	Power Dissipated as Heat			"Line current (amps)"	Power Dissipated as Heat		
			watts	BTU	kcal/hr		watts	BTU	kcal/hr
At Idle Awake	N/A	2.9	318	1086	274	2.1	342	1167	294
<b>1/8 Power Pink Noise</b> Typical of program material just at clip	4Ω	20.5	889	3033	765	11.3	951	3247	819
	8Ω	14.5	631	2153	543	7.6	679	2318	584
	16Ω	8.3	442	1510	381	4.5	490	1672	422
	140V (8Ω)	16.5	767	2619	660	8.9	847	2892	729
	200V (16Ω)	15.9	685	2338	589	8.6	721	2462	621
<b>1/3 Power Pink Noise</b> Typical of program material at extreme clip	4Ω	50.3	1966	6711	1692	23.9	1778	6069	1530
	8Ω	32.6	1212	4137	1043	16.6	1100	3754	946
	16Ω	16.3	609	2080	524	9.0	595	2031	512
	140V (8Ω)	37.0	1381	4714	1188	18.2	1370	4677	1179
	200V (16Ω)	37.8	1177	4017	1013	19.5	1153	3936	992

DCi 4 2400N - Dual									
P1-32		120 VAC / 60 Hz				230 VAC / 50 Hz			
Condition	Load	"Line current (amps)"	Power Dissipated as Heat			"Line current (amps)"	Power Dissipated as Heat		
			watts	BTU	kcal/hr		watts	BTU	kcal/hr
At Idle Awake	N/A	2.9	318	1085	273	2.0	338	1153	291
<b>1/8 Power Pink Noise</b> Typical of program material just at clip	2Ω	16.3	867	2958	746	8.8	869	2966	748
	4Ω	17.2	635	2166	546	9.2	786	2683	676
	8Ω	13.2	533	1821	459	7.1	548	1870	471
	70V (4Ω)	17.9	995	3397	856	8.6	871	2973	749
	100V (8Ω)	17.0	887	3028	763	9.3	817	2787	703
<b>1/3 Power Pink Noise</b> Typical of program material at extreme clip	2Ω	37.2	1810	6177	1557	20.6	1544	5270	1328
	4Ω	39.8	1342	4581	1155	20.3	1197	4085	1030
	8Ω	31.2	909	3104	782	15.3	996	3399	857
	70V (4Ω)	40.1	1789	6107	1539	19.6	1503	5131	1293
	100V (8Ω)	40.4	1688	5760	1452	19.8	1205	4112	1037

# AC Power Draw and Thermal Dissipation

## AC Power Draw and Thermal Dissipation:

Pink noise 12dB crest factor, bandwidth limited 22Hz to 22kHz.

Typical line impedance used.

Data based on all channels driven.

DCi 8300N - Bridge									
P1-32		120 VAC / 60 Hz				230 VAC / 50 Hz			
Condition	Load	"Line current (amps)"	Power Dissipated as Heat			"Line current (amps)"	Power Dissipated as Heat		
			watts	BTU	kcal/hr		watts	BTU	kcal/hr
At Idle Awake	N/A	1.8	206	705	178	0.9	201	686	173
<b>1/8 Power Pink Noise</b> Typical of program material just at clip	4Ω	3.5	260	886	223	1.8	261	890	224
	8Ω	4.9	277	944	238	2.5	259	884	223
	16Ω	4.7	251	857	216	2.4	232	792	200
	140V (32.67Ω)	4.6	236	806	203	2.4	226	770	194
	200V (66.67Ω)	4.5	236	805	203	2.3	216	737	186
<b>1/3 Power Pink Noise</b> Typical of program material at extreme clip	4Ω	6.5	357	1220	308	3.3	335	1144	288
	8Ω	10.0	377	1287	324	5.2	369	1259	317
	16Ω	9.5	313	1069	269	4.8	305	1041	263
	140V (32.67Ω)	9.4	296	1011	255	4.8	279	951	240
	200V (66.67Ω)	9.2	287	979	247	4.8	273	932	235

DCi 8 300N - Dual									
P1-32		120 VAC / 60 Hz				230 VAC / 50 Hz			
Condition	Load	"Line current (amps)"	Power Dissipated as Heat			"Line current (amps)"	Power Dissipated as Heat		
			watts	BTU	kcal/hr		watts	BTU	kcal/hr
At Idle Awake	N/A	1.8	203	693	175	0.9	201	685	173
<b>1/8 Power Pink Noise</b> Typical of program material just at clip	2Ω	3.9	276	941	237	2.1	267	913	230
	4Ω	4.8	276	943	238	2.5	261	891	225
	8Ω	4.9	252	859	217	2.5	237	807	204
	70V (16.33Ω)	4.5	222	759	191	2.4	222	756	191
	100V (33.33Ω)	4.5	228	779	196	2.4	219	746	188
<b>1/3 Power Pink Noise</b> Typical of program material at extreme clip	2Ω	6.7	353	1206	304	3.4	343	1171	295
	4Ω	9.9	341	1165	294	5.0	318	1085	273
	8Ω	9.5	312	1066	269	4.8	293	1000	252
	70V (16.33Ω)	9.4	304	1037	262	4.8	275	938	237
	100V (33.33Ω)	9.2	295	1007	254	4.7	270	923	233

# AC Power Draw and Thermal Dissipation

## AC Power Draw and Thermal Dissipation:

Pink noise 12dB crest factor, bandwidth limited 22Hz to 22kHz.

Typical line impedance used.

Data based on all channels driven.

DCi 8 600N - Bridge									
15004563770		120 VAC / 60 Hz				230 VAC / 50 Hz			
Condition	Load	"Line current (amps)"	Power Dissipated as Heat			"Line current (amps)"	Power Dissipated as Heat		
			watts	BTU	kcal/hr		watts	BTU	kcal/hr
At Idle Awake	N/A	1.9	218	744	188	1.0	220	751	189
<b>1/8 Power Pink Noise</b> Typical of program material just at clip	4Ω	5.4	330	1126	284	2.8	325	1109	279
	8Ω	8.1	346	1181	298	4.2	335	1144	288
	16Ω	7.7	306	1044	263	3.8	276	941	237
	140V (16Ω)	7.7	300	1023	258	3.9	285	973	245
	200V (33.33Ω)	7.5	281	960	242	3.9	272	929	234
<b>1/3 Power Pink Noise</b> Typical of program material at extreme clip	4Ω	10.8	468	1597	403	5.4	445	1519	383
	8Ω	17.9	530	1810	456	9.0	476	1625	410
	16Ω	17.0	421	1437	362	8.7	389	1328	335
	140V (16Ω)	17.3	439	1500	378	8.8	382	1305	329
	200V (33.33Ω)	17.0	412	1407	355	8.6	342	1168	294

DCi 8600N - Dual									
15004563770		120 VAC / 60 Hz				230 VAC / 50 Hz			
Condition	Load	"Line current (amps)"	Power Dissipated as Heat			"Line current (amps)"	Power Dissipated as Heat		
			watts	BTU	kcal/hr		watts	BTU	kcal/hr
At Idle Awake	N/A	1.9	222	756	191	1.0	221	754	190
<b>1/8 Power Pink Noise</b> Typical of program material just at clip	2Ω	5.5	336	1147	298	3.0	332	1133	286
	4Ω	8.2	363	1241	313	4.4	348	1186	299
	8Ω	7.8	314	1071	270	4.1	293	999	252
	70V (16.33Ω)	7.6	307	1047	264	4.0	289	979	274
	100V (33.33Ω)	7.8	293	1001	252	3.9	262	896	226
<b>1/3 Power Pink Noise</b> Typical of program material at extreme clip	2Ω	11.0	498	1700	429	5.9	476	1625	410
	4Ω	17.5	510	1739	438	10.0	547	1868	471
	8Ω	17.4	467	1593	402	9.1	421	1437	362
	70V (16.33Ω)	17.0	446	1522	384	9.0	393	1342	338
	100V (33.33Ω)	16.8	419	1430	360	8.9	362	1234	311

# Service

Crown products are quality units that rarely require servicing. Before returning your unit for servicing, please contact Crown Technical Support to verify the need for servicing.

*Warranty is only valid within the country in which the product was purchased.*

This unit has very sophisticated circuitry which should only be serviced by a fully trained technician. This is one reason why each unit bears the following label:



**CAUTION: To prevent electric shock, do not remove covers. No user serviceable parts inside. Refer servicing to a qualified technician.**

Complete the Service Return Authorization form in the back of this manual, when returning a Crown product to the factory or authorized service center. The form must be included with your product inside the box or in a packing slip envelope securely attached to the outside of the shipping carton. Do not send this form separately.

## Worldwide Service

Service may be obtained from an authorized service center (contact your local Crown/Amcron representative or our office for a list of authorized service centers). To obtain service, simply present the bill of sale as proof of purchase along with the defective unit to an authorized service center. They will handle the necessary paperwork and repair.

Remember to transport your unit in the original factory pack.

## US and Canada Service

Service may be obtained in one of two ways: from an authorized service center or from the factory. You may choose either. It is important that you have your copy of the bill of sale as your proof of purchase.

### Service at a US or Canada Service Center

This method usually saves the most time and effort. Simply present your bill of sale along with the defective unit to an authorized service center to obtain service. They will handle the necessary paperwork and repair. Remember to transport the unit in the original factory pack. A list of authorized service centers in your area can be obtained from Crown Factory Service, or online from [http://www.crownaudio.com/en/support/service\\_lookup](http://www.crownaudio.com/en/support/service_lookup)

### Factory Service

Crown accepts no responsibility for non-serviceable product that is sent to us for factory repair. It is the owner's responsibility to ensure that their product is serviceable prior to sending it to the factory.

A Service Return Authorization (SRA) is required for product being sent to the factory for repair. An SRA can be completed online at <http://www.crownaudio.com/support/rma>. If you do not have access to the web, please call Customer Service at 574.294.8200 or 800.342.6939 extension 8205 in North America, Puerto Rico and the Virgin Islands only.

For warranty service, we will pay for ground shipping both ways in the United States. Contact Customer Service to obtain prepaid shipping labels prior to sending the unit. Or, if you prefer, you may prepay the cost of shipping, and HARMAN will reimburse you. Send copies of the shipping receipts to HARMAN to receive reimbursement.

Your repaired unit will be returned via UPS ground. Please contact us if other arrangements are required.

### Factory Service Shipping Instructions:

1. Service Return Authorization (SRA) is required for product being sent to the factory for service. Please complete the SRA by going to <http://www.crownaudio.com/support/rma>. If you do not have access to our website, call 1.800.342.6939, extension 8205 and we will create the SRA for you.
2. See packing instructions that follow.
3. Ship product to:  
HARMAN Factory Service  
1718 W Mishawaka Rd.  
Elkhart, IN 46517

## Service

4. Use a bold black marker and write the SRA number on three sides of the box.
5. Record the SRA number for future reference. The SRA number can be used to check the repair status.

### Packing Instructions

Important: These instructions must be followed. If they are not followed, HARMAN International, Inc. assumes no responsibility for damaged goods and/or accessories that are sent with your unit.

1. Fill out and include the Service Return Authorization Request in the back of this manual.
2. Do not ship any accessories (manuals, cords, hardware, etc.) with your unit. These items are not needed to service your product. We will not be responsible for these items.
3. When shipping your Crown product, it is important that it has adequate protection. We recommend you use the original pack material when returning the product for repair. If you do not have the original box, please call HARMAN at 800.342.6939 or 574.294.8210 and order new pack material. (Do not ship your unit in a wood or metal cabinet).
4. If you provide your own shipping pack, the minimum recommended requirements for materials are as follows:
  - a. 275 P.S.I. burst test, double-wall carton that allows for 2-inch solid Styrofoam on all six sides of unit or 3 inches of plastic bubble wrap on all six sides of unit.
  - b. Securely seal the package with an adequate carton sealing tape.
  - c. Do not use light boxes or "peanuts". Damage caused by poor packaging will not be covered under warranty.

Enclose the completed Service Return Authorization Request (or securely attach it to the outside of carton) and re-seal the shipping pack with a sturdy carton sealing tape.

### Estimate Approval

Approval of estimate must be given within 30 days after being notified by HARMAN International. Units still in the possession of HARMAN after 30 days of the estimate will become the property of HARMAN International.

### Payment of Non-Warranty Repairs

Payment on out-of-warranty repairs must be received within 30 days of the repair date. Units unclaimed after 30 days become the property of HARMAN International.

If you have any questions, please contact HARMAN.

#### **HARMAN Factory Service**

1718 W. Mishawaka Rd.,  
Elkhart, Indiana 46517 U.S.A.

#### **Telephone:**

574-294-8200  
800-342-6939 (North America, Puerto Rico, and Virgin Islands only)

#### **Facsimile:**

574-294-8301 (Technical Support)  
574-294-8124 (Factory Service)

#### **Web site:**

[www.crownaudio.com](http://www.crownaudio.com)



# Warranty — UNITED STATES ONLY



## SUMMARY OF WARRANTY

Crown International, 1718 West Mishawaka Road, Elkhart, Indiana 46517-4095 U.S.A. warrants to you, the ORIGINAL PURCHASER and ANY SUBSEQUENT OWNER of each NEW Crown product, for three years from the date of purchase by the original purchaser (the “warranty period”) that the new Crown product is free of defects in materials and workmanship. We further warrant the new Crown product regardless of the reason for failure, except as excluded in this Warranty.

*\*Warranty is only valid within the United States of America. For information on Warranty outside of the U.S.A, please contact your local distributor.*

## ITEMS EXCLUDED FROM THIS CROWN WARRANTY

This Crown Warranty is in effect only for failure of a new Crown product which occurred within the Warranty Period. It does not cover any product which has been damaged because of any intentional misuse, accident, negligence, or loss which is covered under any of your insurance contracts. This Crown Warranty also does not extend to the new Crown product if the serial number has been defaced, altered, or removed.

## WHAT THE WARRANTOR WILL DO

We will remedy any defect, regardless of the reason for failure (except as excluded), by repair, replacement, or refund. We may not elect refund unless you agree, or unless we are unable to provide replacement, and repair is not practical or cannot be timely made. If a refund is elected, then you must make the defective or malfunctioning product available to us free and clear of all liens or other encumbrances. The refund will be equal to the actual purchase price, not including interest, insurance, closing costs, and other finance charges less a reasonable depreciation on the product from the date of original purchase. Warranty work can only be performed at our authorized service centers or at the factory. Warranty work for some products can only be performed at our factory. We will remedy the defect and ship the product from the service center or our factory within a reasonable time after receipt of the defective product at our authorized service center or our factory. All expenses in remedying the defect, including surface shipping costs in the United States, will be borne by us. (You must bear the expense of shipping the product between any foreign country and the port of entry in the United States including the return shipment, and all taxes, duties, and other customs fees for such foreign shipments.)

## HOW TO OBTAIN WARRANTY SERVICE

You must notify us of your need for warranty service within the warranty period. All components must be shipped in a factory pack, which, if needed, may be obtained from us free of charge. Corrective action will be taken within a reasonable time of the date of receipt of the defective product by us or our authorized service center. If the repairs made by us or our authorized service center are not satisfactory, notify us or our authorized service center immediately.

## DISCLAIMER OF CONSEQUENTIAL AND INCIDENTAL DAMAGES

YOU ARE NOT ENTITLED TO RECOVER FROM US ANY INCIDENTAL DAMAGES RESULTING FROM ANY DEFECT IN THE NEW CROWN PRODUCT. THIS INCLUDES ANY DAMAGE TO ANOTHER PRODUCT OR PRODUCTS RESULTING FROM SUCH A DEFECT. SOME STATES DO NOT ALLOW THE EXCLUSION OR LIMITATIONS OF INCIDENTAL OR CONSEQUENTIAL DAMAGES, SO THE ABOVE LIMITATION OR EXCLUSION MAY NOT APPLY TO YOU.

## WARRANTY ALTERATIONS

No person has the authority to enlarge, amend, or modify this Crown Warranty. This Crown Warranty is not extended by the length of time which you are deprived of the use of the new Crown product. Repairs and replacement parts provided under the terms of this Crown Warranty shall carry only the unexpired portion of this Crown Warranty.

## DESIGN CHANGES

We reserve the right to change the design of any product from time to time without notice and with no obligation to make corresponding changes in products previously manufactured.

## LEGAL REMEDIES OF PURCHASER

THIS CROWN WARRANTY GIVES YOU SPECIFIC LEGAL RIGHTS, YOU MAY ALSO HAVE OTHER RIGHTS WHICH VARY FROM STATE TO STATE. No action to enforce this Crown Warranty shall be commenced after expiration of the warranty period.

THIS STATEMENT OF WARRANTY SUPERSEDES ANY OTHERS CONTAINED IN THIS MANUAL FOR CROWN PRODUCTS.  
04/15

# Service Return Authorization Request

Shipping Address: HARMAN Factory Service, 1718 W. Mishawaka Rd., Elkhart, IN 46517  
You may also request a service return authorization at [www.crownaudio.com/support/rma](http://www.crownaudio.com/support/rma)

**PLEASE PRINT CLEARLY**

SRA #: \_\_\_\_\_ (If sending product to Crown factory service)  
Model: \_\_\_\_\_ Serial Number: \_\_\_\_\_ Purchase Date: \_\_\_\_\_

**PRODUCT RETURN INFORMATION**

Individual or Business Name: \_\_\_\_\_  
Phone #: \_\_\_\_\_ Fax #: \_\_\_\_\_ E-Mail: \_\_\_\_\_  
Street Address (please, no P.O. Boxes): \_\_\_\_\_  
City: \_\_\_\_\_ State/Prov: \_\_\_\_\_ Postal Code: \_\_\_\_\_ Country: \_\_\_\_\_  
Nature of problem: \_\_\_\_\_  
\_\_\_\_\_  
\_\_\_\_\_  
\_\_\_\_\_

Other equipment in your system: \_\_\_\_\_  
If warranty is expired, please provide method of payment. Proof of purchase may be required to validate warranty.

**PAYMENT OPTIONS**

- I have open account payment terms. Purchase order required. PO#: \_\_\_\_\_  COD
- Credit Card (Information below is required; however if you do not want to provide this information at this time, we will contact you when your unit is repaired for the information.)

Credit card information:

Type of credit card:  MasterCard  Visa  American Express  Discover

Type of credit card account:  Personal/Consumer  Business/Corporate

Card # \_\_\_\_\_ Exp. date: \_\_\_\_\_ \*Card ID #: \_\_\_\_\_

\*Card ID # is located on the back of the card following the credit card #, in the signature area. On American Express, it may be located on the front of the card. This number is required to process the charge to your account. If you do not want to provide it at this time, we will call you to obtain this number when the repair of your unit is complete.

Name on credit card: \_\_\_\_\_

Billing address of credit card: \_\_\_\_\_  
\_\_\_\_\_  
\_\_\_\_\_





