

HANOVER®

Hanover Outdoor Furniture



IMPORTANT

If you have any problems with this product (missing or damaged parts, assembly issues, etc.),

PLEASE DO NOT RETURN TO THE RETAILER/STORE

from where you purchased the product.

Please call our Toll-Free Customer Service Hotline at: **1-800-416-3511**

Between 9:00 AM and 5:00 PM Eastern Time, Monday through Friday

Or visit our website at: **www.hanover-products.com**

To expedite any future warranty claims, please retain the Instruction Sheet, Warranty Card and receipt for future use.

For additional on-line support on assembly, troubleshooting and care & maintenance of your outdoor furniture, please visit our website at: **www.hanover-products.com**.

ASSEMBLY INSTRUCTIONS



CSA Model 98900

Printed in China

DRC02200

Installer: Leave these instructions with consumer.

Consumer: Keep these instructions for future reference.

⚠ DANGER
If you smell gas:

1. Shut off gas to the appliance.
2. Extinguish any open flame.
3. If odor continues, keep away from the appliance and immediately call your gas supplier or fire department.

⚠ WARNING:
Improper installation, adjustment alteration, service or maintenance can cause injury or property damage. Read the installation, operating and maintenance instructions thoroughly before installing or servicing this equipment.

⚠ WARNING
Do not store or use gasoline or other flammable vapors and liquids in the vicinity of this or any other appliance. An LP-cylinder not connected for use shall not be stored in the vicinity of this or any other appliance.

⚠ WARNING: For Outdoor Use Only

FOR USE WITH 20LB (9KG) PROPANE CYLINDER WITH TYPE 1 CONNECTION OR FOR USE WITH NATURAL GAS AFTER CONVERSION KIT IS INSTALLED (MUST BE PROFESSIONALLY INSTALLED) ALSO THE LP REGULATOR MUST BE SUPPLIED BY THE MANUFACTURER.

⚠ DANGER	CARBON MONOXIDE HAZARD
	<p>This appliance can produce carbon monoxide which has no odor. Using it in an enclosed space can kill you.</p> <p>Never use this appliance in an enclosed space such as a camper, tent, car or home.</p>

WARNING:
USE FACTORY APPROVED REPLACEMENT PARTS AND ACCESSORIES ONLY. USE OF UNAPPROVED PART OR ACCESSORIES CAN VOID THE WARRANTY ON THIS PRODUCT AND RESULT IN A HAZARDOUS CONDITION. PLEASE CONTACT US FOR INFORMATION REGARDING REPLACEMENT HOSES, THERMOCOUPLES, ELECTRODES, IGNITION MODULES, LAVAROCKS, LOGS, FIRE ICE, ETC.



Questions, Problems, Missing Parts? Before returning to your retailer, call our customer service department in the US and Canada at 1-800-416-3511, Monday-Friday, 9 a.m. – 5 p.m. Eastern Time.

IMPORTANT SAFETY INFORMATION

The installation must conform with local codes or, in the absence of local codes, with the National Fuel Gas Code, ANSI Z223.1/NFPA 54; International Fuel Gas Code. ; Natural Gas and Propane Installation Code, CSA B149.1; or Propane Storage and Handling Code, B149.2, as applicable.

The appliance and its appliance main gas valve must be disconnected from the gas supply piping system during any pressure testing of that system at test pressures in excess of 1/2 psi (3.5kPa).

The appliance must be isolated from the gas supply piping system by closing its equipment shutoff valve during any pressure testing of the gas supply system at test pressure equal to or less than 1/2 psi (3.5kPa).

The appliance area must be kept clear and free from combustible materials, gasoline and other flammable vapors and liquids.

Do not use this appliance if any part has been under water. Immediately call a qualified service technician to inspect the appliance and to replace any part of the control system and any gas control which has been under water.

Children and adults should be alerted to the hazards of high surface temperatures and kept at a safe distance to avoid burns or clothing ignition.

Young children should be carefully supervised when they are anywhere near the appliance.

Clothing or other flammable material should not be hung from the appliance, or placed on or near the appliance.

Any screen or guard removed for servicing an appliance must be replaced prior to operating the appliance.

Installation and repair should be done by a qualified service person. The appliance should be inspected before use and at least annually by a professional service person. More frequent cleaning may be required as necessary. It is imperative that the control compartments, burners and circulating air passageways of the appliance be kept clean.

Do NOT burn solid fuels in this gas fireplace.

CAUTION: The propane gas pressure regulator provided with this appliance must be used. This regulator is set for an outlet pressure of 11 inches water column.

This outdoor gas appliance is not intended to be installed in or on recreational vehicles and/or boats.

Before each use of this gas appliance, open the LP (Liquid Propane) Tank Drawer and inspect the LP Hose. If there is evidence of excessive abrasion or wear, or the hose is cut, it must be replaced prior to the gas appliance being put into operation. Use only the replacement hose assembly specified in this manual. Inspect the burner before each use of the appliance. The burner must be replaced prior to the appliance being put into operation if it is evident that the burner is damaged. Use only the burner listed in these instructions.

Keep the fuel supply hose away from any heated surfaces.

IMPORTANT SAFETY INFORMATION ABOUT PROPANE (LP) GAS

A self contained LP-gas cylinder for use with this appliance must have a capacity of 20 lbs. and must be equipped with a Type 1 connector and an OPD (overfill protection device). See Figure 1.

The LP-gas supply cylinder to be used must be constructed and marked in accordance with the specification for LP-gas cylinders of the U.S. Department of Transportation (DOT) or the National Standard of Canada, *CAN/CSA-B339, Cylinder, Sphere and Tubes for the Transportation of Dangerous Goods*.

- The cylinder supply system must be arranged for vapor withdrawal.
- The cylinder used must include a collar to protect the cylinder valve.
- This appliance shall be used only outdoors in a well-ventilated space and shall not be used in a building, garage or any other enclosed space.
- When this appliance is not in use, the gas must be turned off at the supply cylinder.
- Storage of this appliance indoors is permissible only if the cylinder is disconnected and removed from the appliance.
- Cylinders must be stored outdoors in a well-ventilated area out of the reach of children. Disconnected cylinders must have threaded valve plugs tightly installed and must not be stored in a building, garage or any other enclosed areas.

CSA (Canadian Standards Association) certified to ANSI Z21.97•CSA 2.41-2012 “ Outdoor Decorative Gas Appliances”. The gas hose is routed through a “U” bolt to prevent the hose from coming in contact with the burner. DO NOT remove the hose from the “U” bolt. See Figure 2.



Figure 1

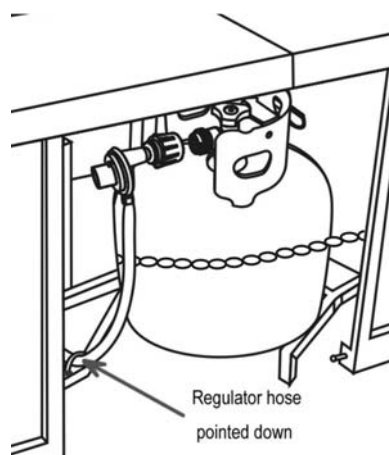

Figure 2 SPECIFICATIONS

INPUT	40,000 Btu/hr	30,000 Btu/hr Low fire
Propane Regulator Pressure	11 inches water column	
Natural Gas Minimum Inlet Pressure	7 inches water column	
Clearances to combustible surfaces	Sides 24in./61cm	Top: 72 in. / 183 cm

THE UNIT HAS BEEN PRE-ASSEMBLED BY MANUFACTURER AND DOES NOT REQUIRE ASSEMBLY BY CUSTOMER.

INSTALLATION

1. Carefully unpack all items from the box. Place the table in its final position. There must be a minimum of 24 inches of clearance from the side of the table top to any combustible walls.
2. With the help of another person, carefully place the natural stone table top onto the table base. After making any necessary adjustments to the alignment of the natural stone table top and the table base, use four bolts and washers as shown in Fig.3. Guide the bolts through hole in the table base into the pre-drilled hole on the underside of the natural stone table top. **Do not tighten completely.**

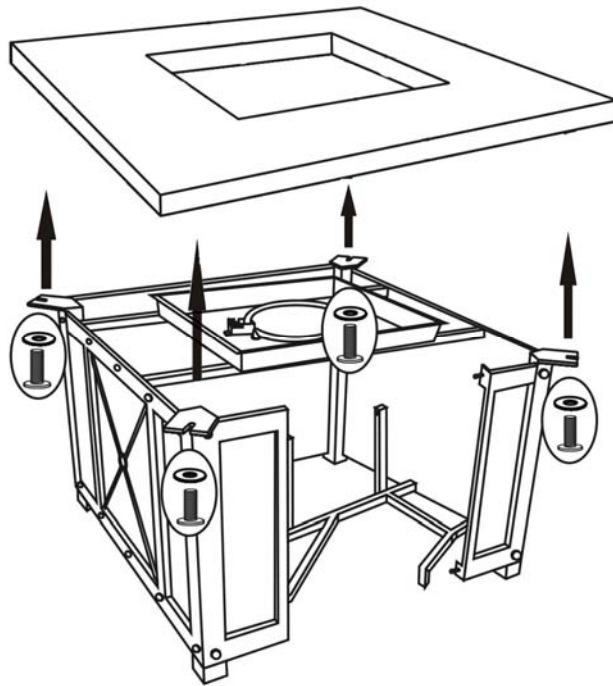
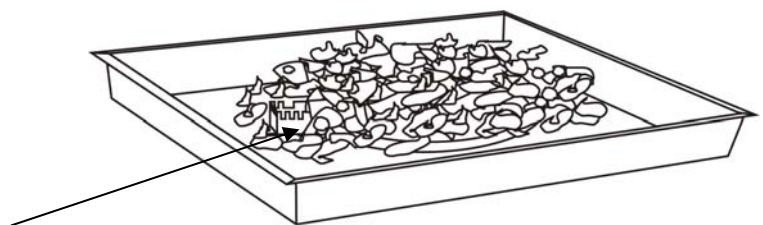

Figure 3

3. Pour all of the lava rock into the burner pan. Completely cover the burner tube with lava rocks as shown in Fig. 4.



Remove any lava rock from the ignition well

Figure 4

4. Lift off the tank door, place the tank in the holder and use the chain to hold the tank. Connect the regulator as shown in Fig. 5. Screw the black handle clock-wise to tighten. Turn the handle counterclock-wise to remove. The hose must point down. Open the control door and check that the valve is turned all the way clockwise to the “OFF” position. Open the tank valve. Apply a solution of soapy water to the tank-regulator connection and to the valve-hose connection to check for leaks. If soap bubbles continue to form, the connection has a leak. If a leak is found, close the tank valve and tighten all connections. **NEVER USE A FLAME TO CHECK FOR LEAKS.**

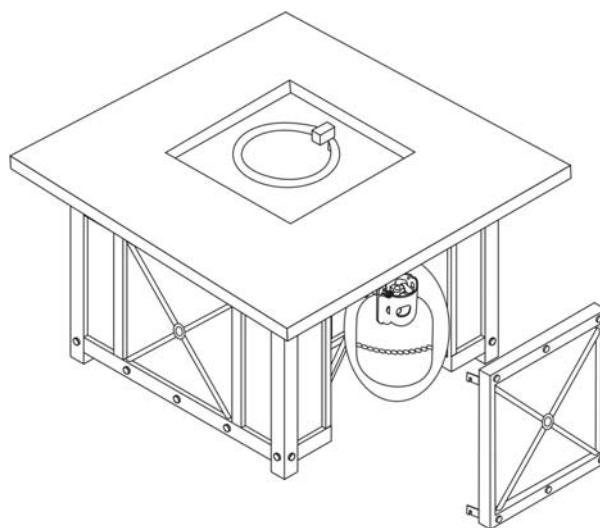

Figure 5



NATURAL GAS CONVERSION



Natural gas conversion must be performed only by natural gas provider or service company.

1. Disconnect the gas hose from the gas valve. See Fig. 6.

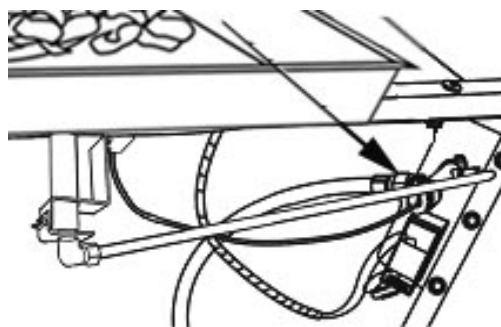

Figure 6

2. Disconnect the gas tube from the orifice and remove the orifice holder as shown in Fig .7.

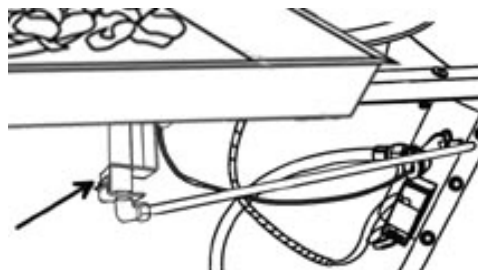

Figure 7

3. Replace the propane orifice (See Fig.8) with the natural gas orifice from the kit and reinstall the orifice holder by tightening the nuts as shown in Fig. 9. Reconnect and tighten the gas tube to the orifice.

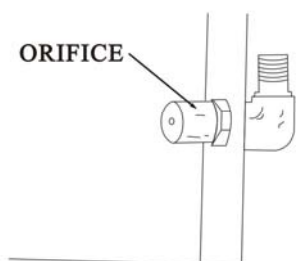

Figure 8

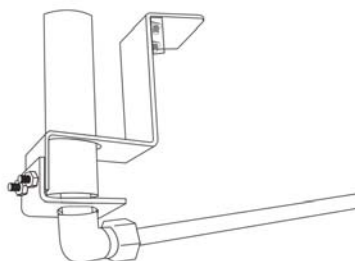

Figure 9

Apply a solution of soapy water to all connections to check for leaks. If soap bubbles continue to form, the connection has a leak. If a leak is found, close the tank valve and tighten all connections. **NEVER USE A FLAME TO CHECK FOR LEAKS.**

4. Stick the conversion label on the rating plate as shown in Fig. 10.

Metal Rating Plate

Serial Number _____	Model Number: 98910
CAUTION: The gas pressure regulator provided with this appliance must be used. This regulator is set for an outlet pressure of	
<div style="border: 1px solid black; padding: 5px; margin: 5px auto; width: 80%;"> <p>This appliance has been converted to use Natural Gas. Input 40,000 Btu/hr. Max Gas Supply Pressure 7 inch w.c. (12.2 kPa) Min. Gas Supply Pressure 5 inch w.c. (1.24 kPa)</p> </div>	
Minimum clearance from combustible constructions: Sides: 24 in.609 mm. Top 72 in. 1828 mm.	
FOR OUTDOOR USE ONLY. If stored indoors, detach and leave cylinder outdoors.	
<div style="border: 1px solid black; padding: 5px; margin: 5px auto; width: 80%;"> <p>⚠ WARNING: Improper installation, adjustment alteration, service or maintenance can cause injury or property damage. Refer to the owner's information manual provided with this appliance. For assistance, or additional information, consult a qualified installer, service agency, or the gas supplier.</p> </div>	

Figure 10

Conversion Label

LIGHTING INSTRUCTIONS

1. Locate the control and igniter panel. Make sure the control knob is in the “OFF” position. See Fig. 11. Open the tank door and open the tank valve all the way.
2. Push in the igniter button. You will hear a slight clicking sound. With the igniter button pushed in, push and turn the control knob to the “ON” position. The fire should light within a few seconds. Once the flame is lit, release the igniter button and continue to hold the control knob in for 10 to 15 seconds. Release the control knob. The control knob should pop back out and the fire should remain lit. Note: If the fire does not light, turn the knob to the “OFF” position and wait five (5) minutes before trying again.
3. To turn down the flame, push the control knob in slightly and turn to the Medium (medium flame) or Low (small flame).
4. To shut down the fire pit, turn the control knob to the “OFF” position and turn off the tank valve

Figure 11

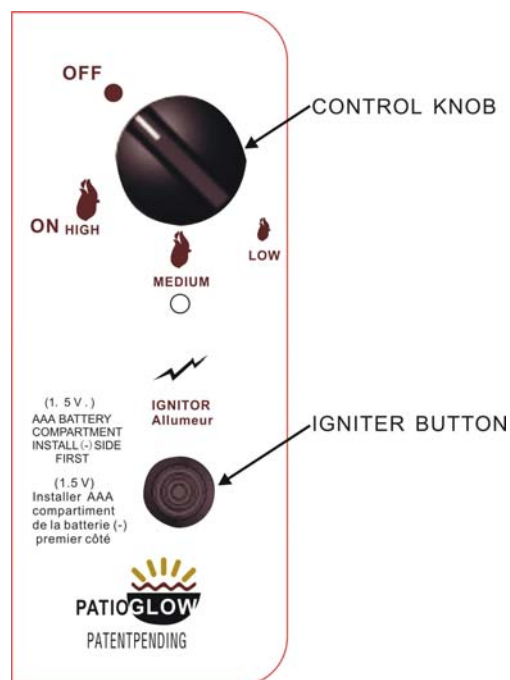

MAINTENANCE

The flames should look like those in Fig. 12. To clean the burner, use a soft brush after the burner and lava rocks have cooled completely. Never use a vacuum cleaner on the lava rocks. It is recommended that the lava rocks be stored indoors during the winter if they will be subjected to freezing temperatures. The propane cylinder must be disconnected and removed from the appliance before the appliance can be stored indoors.



Figure 12

BATTERIES

Make sure the control knob is in the “OFF” position. Unscrew the push button cap on the ignition module located on the control panel to access the battery compartment. The ignition module requires one AAA size battery. See Fig. 13.

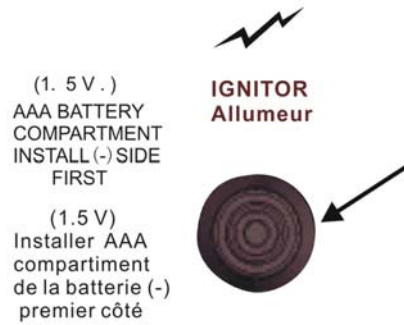

Figure 13

Parts List

Part Number	Description	
FP0002	LAVA ROCKS	Manufactured by: Agio-USA 1337 Taylor Farm Rd #100 Virginia Beach, VA 23453 Service Center: 1-800-416-3511 Made in China
FP0003	ELECTRODE	
FP0004	THERMOCOUPLE	
FP0006	IGNITION MODULE	
FP0008	NATURAL GAS FLEXIBLE CONNECTION HOSE	
FP0432	FIREPIT TABLETOP	
FP0433	FIREPIT BASE	
FC0069	FOOTCAP	
FP0434	HARDWARE PACK	

**IMPORTANT!! PLEASE READ ENTIRE INSTRUCTION SHEET BEFORE ASSEMBLY!!
TO EXPEDITE ANY FUTURE WARRANTY CLAIMS, PLEASE KEEP INSTRUCTION SHEET, WARRANTY CARD AND RECEIPT**

Step 1: Identify all parts packed in carton against the parts list. Remove all protective materials. Place parts on a non-abrasive surface to avoid scratching. If you are missing any parts or are unsure how to proceed with the assembly, call our Customer Service Center at 1-800-416-3511. **Do not attempt assembly if any parts are missing or damaged.**













Step 2: Attach the seat frame to the left chair frame by using three 1/4"x48 mm bolts and washers as shown in Fig.1. Guide bolts through holes in the seat frame and left chair frame, add a nut with washer to each bolt. **Hand tighten only.** Repeat for the right chair frame.

Step 3: Attach the back frame to the left chair frame by using two 1/4"x68 mm bolts and washers as shown in Fig.2. Guide bolts through holes in the back frame and left chair frame, add a nut with washer to each bolt. **Hand tighten only.** Repeat for the right chair frame.

Step 4: After making any necessary adjustments to the alignment of the frames, use the hex bolt driver and hex wrench to tighten all nuts and bolts. **Do not over tighten.** Over tightening may strip bolts. Cover all nuts and bolts with covers. Your sectional sofa is now ready for use.

IMPORTANT NOTE: Damage to welds or frames resulting from over tightened bolts or improper assembly is not covered under our warranty. Please read all instructions carefully before assembly. If you have any questions regarding your assembly, call our Customer Service Center at 1-800-416-3511.

* NOTE: PARTS SHOWN ON PARTS LIST ARE NOT TO SCALE

	PART LIST	DESCRIPTION	ORDER PART #	QTY		PART LIST	DESCRIPTION	ORDER PART #	QTY
A		LEFT CHAIR FRAME		1	H		1/4" NUT	HW0014	10
B		RIGHT CHAIR FRAME		1	I		NUT COVER	HW0027	10
C		BACK FRAME		1	J		BOLT COVER	HW0105	10
D		SEAT FRAME		1	K		HEX WRENCH	HW0009	1
E		1/4" X 48 MM BOLT	HW0274	6	L		HEX BOLT DRIVER	HW0006	1
F		1/4" X 68 MM BOLT	HW0447	4			FOOT CAP FACTORY ASSEMBLY	FC0030	
G		Ø6.5 X 1.0 MM WASHER	HW0004	20					

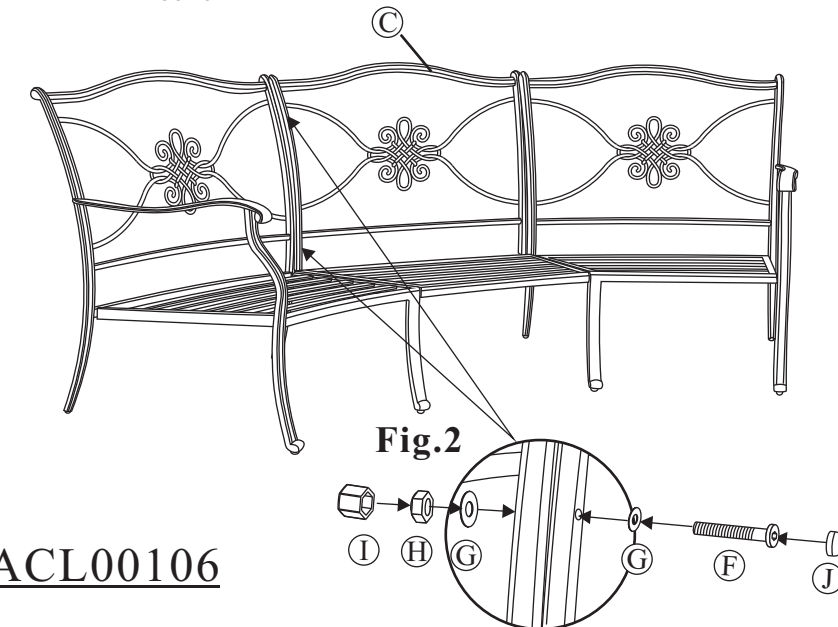
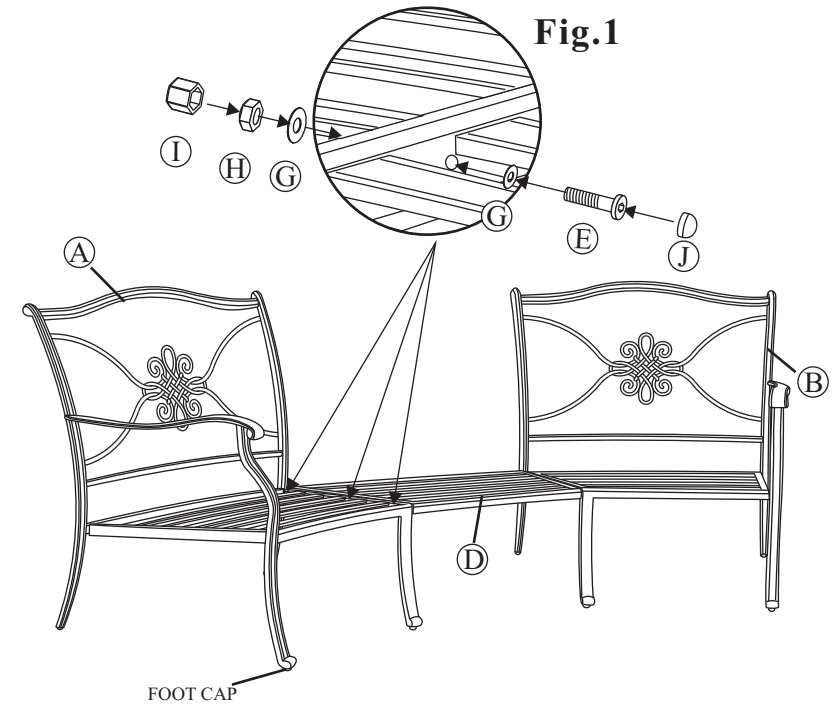

ACL00106