

HANOVER[®]

Hanover Outdoor Furniture



IMPORTANT

If you have any problems with this product (missing or damaged parts, assembly issues, etc.),

PLEASE DO NOT RETURN TO THE RETAILER/STORE

from where you purchased the product.

Please call our Toll-Free Customer Service Hotline at: **1-800-416-3511**

Between 9:00 AM and 5:00 PM Eastern Time, Monday through Friday

Or visit our website at: **www.hanover-products.com**

To expedite any future warranty claims, please retain the Instruction Sheet, Warranty Card and receipt for future use.

For additional on-line support on assembly, troubleshooting and care & maintenance of your outdoor furniture, please visit our website at: **www.hanover-products.com**.

Outdoor Furniture

1-Year Limited Warranty Program

For a period of one (1) year after purchase, the Manufacturer will either repair or replace defective components in accordance with this Limited Warranty. This warranty is between Manufacturer and the original purchaser and is valid only when accompanied by the original purchaser's sales receipt showing original date of purchase and location of purchase. Replacements under this warranty revert back to the date of original purchase for future warranty.

Manufacturer or its authorized dealer can accept or reject warranty claims based on its findings. This warranty applies in normal residential use only and is not intended for commercial use. Manufacturer can make substitutions as required of materials, components, and sub-components of comparable value and utility. This warranty is limited to product repair or replacement (to be determined solely by Manufacturer). Warranty return is limited to only the single affected component.

This warranty covers only manufacturing defects and does not cover normal wear and tear, damage due to acts of nature (such as, but not limited to freezing or high winds), abuse or misuse, including chemical damage from suntan oil or other chemicals, exposure to extreme heat or cold, abrasion or excessive weight. This product is intended to be used in standard installations only. This warranty is invalid if the product is not used for intended purpose. Manufacturer disclaims liability for any aspect of installation and any inconvenience caused by a defective part of a component.

Certain items are not covered by this warranty. These include, but are not limited to the following:

1. Components subjected to abuse, including abuse intended to simulate failure.
2. Damages caused by retailer, shipper or installation crew (such as scratches, dents, tears, chips, etc.).
3. Any part which merely exhibits normal wear yet functions essentially as new, including chips, scratches or stretching of materials and stitching.
4. Tears, punctures, scratches or any damage caused by improper installation or use.
5. Damage to frames/welds resulting from improper assembly or exposure to water and/or sub-freezing temperatures is not covered. General frame rusting is not covered.
6. Fading and/or discoloration of fabrics/cushions/straps/wicker resulting from exposure to the elements, chemicals, oils, fluids or any other cause are not covered.
7. Umbrella bases are not covered under any circumstances.
8. Items sold "as is" or floor models.

To make a claim, call the toll-free number below. Please have available a copy of the original sales receipt along with a brief description of the problem. Please also provide your email address and daytime telephone or cell phone #. Repairs or replacement will be made at the Manufacturer's option. *Sales and use taxes, plus shipping and handling charges are the responsibility of the consumer.*

THIS IS THE ENTIRE EXCLUSIVE EXPRESS LIMITED LIABILITY. THE MANUFACTURER NEITHER MAKES NOR IS RESPONSIBLE FOR ANY OTHER WARRANTIES, EITHER EXPRESS OR IMPLIED, INCLUDING THOSE OF RETAILING DEALERS. THIS EXCLUSIVE REMEDY IS LIMITED TO RECEIPT OF A CREDIT IN CONNECTION WITH THE REPAIR OR REPLACEMENT OF ANY PRODUCT OR COMPONENT DEEMED TO BE DEFECTIVE UNDER THE TERMS AND CONDITIONS AS STATED IN THIS WARRANTY. NEITHER THE PRODUCT MANUFACTURER NOR ITS AGENTS SHALL BE LIABLE IN ANY CASE FOR INCIDENTAL, INDIRECT, SPECIAL OR CONSEQUENTIAL DAMAGES RESULTING FROM THE USE OF THIS PRODUCT OR ARISING OUT OF ANY BREACH OF THIS WARRANTY OR NEGLIGENCE EVEN IF IT HAS BEEN ADVISED OF THE POSSIBILITY OF SUCH DAMAGES. EXCEPT AS OTHERWISE MAY BE REQUIRED BY LAW, THERE ARE NO OTHER EXPRESS OR IMPLIED WARRANTIES OTHER THAN THE WARRANTY DESCRIBED HEREIN, AND ALL OTHER WARRANTIES, INCLUDING ANY IMPLIED WARRANTY OF

Contact Warranty Services at **1-800-416-3511**

Care & Maintenance

Outdoor furniture can be enjoyed for many years when well maintained.

Regular Maintenance

Wash the furniture with a solution of mild detergent and water, rinse with clear water, and dry thoroughly. To all metal frames, apply a fine, clear automobile wax for maximum protection against harmful ultraviolet exposure and salt air.

For best protection, perform this maintenance two or three times per year in low pollution areas or more frequently in high pollution areas. Please note that these durable materials can be safely cleaned as often as desired. Note: Some suntan and sun block products may be harmful to resin, cushions and strap, mesh and vinyl lace and strap. Do not allow such products to come in contact with any seating surfaces to avoid deep penetrating stains, which are not covered under warranty.

How to Clean & Care for Teak Furnishings

Left alone to age, the natural color of teak furnishings will weather to a soft, silver grey. This process will take approximately nine months, depending on the degree of sunlight and rain exposure. Imperfections, which are inherent properties of the wood, will show over time, enhancing the beauty of the furniture. In humid or wet climates, or after rains, the wood may naturally expand and contract, causing the grain to rise. This is to be expected with exposure to the elements and will stabilize after the initial weathering occurs. To maintain teak furnishings, use a soft bristled utility brush and stroke lightly in the direction of the grain to remove surface dust. For more stubborn dirt, the wood may be washed with a mild solution of four parts laundry detergent or dish washing soap to one part bleach in water, then rinsed thoroughly and allowed to dry completely. Oiling the wood may cause mildew or irregular coloring.

How to Clean Woven Furnishings

Woven furnishings are made of durable and weatherproof extruded polyethylene resin weave. Light stains and soils may be removed with a solution of mild detergent and water, rinsed with clear water and dried thoroughly. Mildew and heavy stains can be removed with a quality commercial outdoor furniture cleaner and protectant. Woven furnishings may not be suitable for intensely hot climates.

How to Clean Fabric

Fine outdoor fabrics are designed to endure years of sun, soil and moisture. Wash outdoor cushions with a solution of mild detergent and water and thoroughly rinse with clear water. Stand cushions on end and allow to air dry completely. Light stains can be removed as above. Mildew and heavy stains can be removed with a quality commercial outdoor furniture cleaner and protectant. Note: Do not dry clean or use a washing machine or dryer. Do not steam or use water at temperatures above 100° F when washing. Note: Be careful to keep the outdoor furniture cleaner from contact with the cushions of your outdoor furniture, as it will cause discoloration. Do not use bleach on printed acrylic fabrics. Do not use solvent-type materials on woven vinyl, woven blend or ultra woven blend fabrics as they will damage the yarns. Do not use chlorine based cleaners.

How to Clean Mesh

Remove light stains with a solution of mild detergent and water, then rinse with clear water and dry thoroughly. Mildew and heavy stains can be removed with a quality commercial outdoor furniture cleaner and protectant.

How to Clean Strap

For general or light cleaning, begin by brushing dirt off the strap. Apply a solution of mild detergent and warm water and allow it to soak into the strap. Gently clean with a sponge or soft bristle brush, then rinse thoroughly with clear water and allow the strap to air dry.

How to Clean Vinyl Strap

Apply a quality vinyl protectant to guard against the effects of air pollution, salt air build-up, and mildew. To remove difficult stains use rubbing alcohol applied with a soft cloth.

How to Clean & Care for Stone and Marble Tops

Tabletops are designed for normal outdoor use in residential settings. To maintain the natural beauty we recommend resealing your table top when necessary, with the same sealer product applied during the manufacturing process. The sealer penetrates the stone and acts as a repellent, preventing absorption of moisture and stainable materials.

If tabletop is stained with products such as wine, soda, coffee, or other colorants of organic origin, clean these spills immediately with a mild detergent then rinse with water. In extreme cold climates, it is recommended that tabletops be stored in a dry indoor area or be covered with suitable outdoor furniture cover. Be sure to allow space between the tabletop and the cover so that moisture does not collect on the table; this will promote airflow and allow moisture to escape.

ASSEMBLY INSTRUCTIONS

1

Position the swivel base on a flat, solid surface. Make sure the swivel plate is positioned all the way into the base. It may have vibrated out during shipment. The two sets of holes in the swivel plate should be facing away from you.

Note the arrows on both the swivel plate and the "U" bar portion of the chair frame. Position the chair frame onto the swivel plate so that the two pairs of holes in the "U" bar are exactly aligned with the two pairs of holes in the swivel plate and the arrows on both the "U" bar and swivel plate are pointing in the same direction. Proper positioning of the chair frame on the swivel plate/swivel base assembly, and proper alignment of the holes in the "U" bar with the holes in the swivel plate are critical to the safe, well balanced swiveling motion of the chair.

2

Carefully examine the diagram. Attach a metal plate to two (2) bolts and guide the bolts through the top of one set of holes in the "U" bar (located at the bottom of the chair frame) and into the pair of holes in the swivel plate. From beneath the swivel plate, add a washer, then a spring washer and a nut to the end each bolt. Hand tighten 3-4 revolutions only. Repeat procedure for pair of holes on the opposite side. Again, hand tighten nuts 3-4 revolutions only. Do not tighten nuts completely.





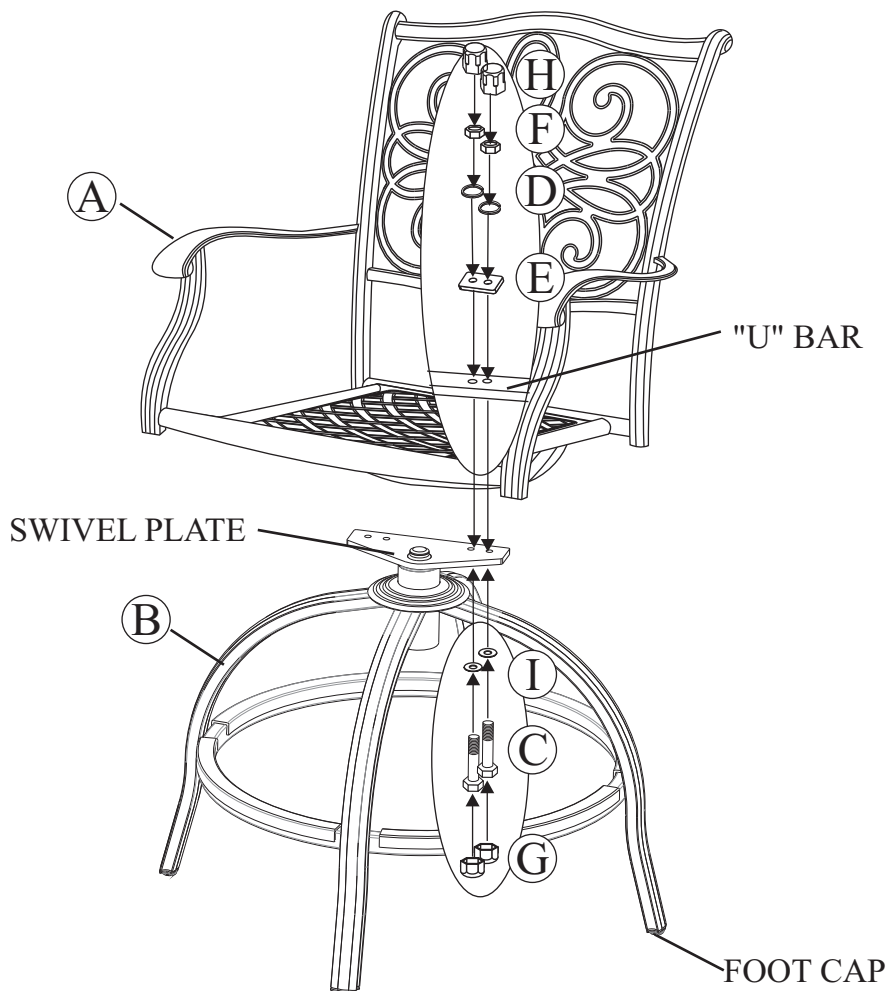





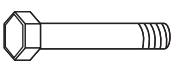

3

Using the hex wrenches provided, tighten the nuts and bolts. Be sure the bolts are fully tightened. Remove arrow labels from the "U" bar and swivel plate. Cover bolts and nuts with covers. Your chair is now ready for use.



PARTS IDENTIFICATION LIST

* NOTE: PARTS SHOWN ON PARTS LIST ARE NOT TO SCALE

	<u>PARTS LIST</u>	<u>DESCRIPTION</u>	<u>ORDER PART #</u>	<u>QTY</u>
A		CHAIR FRAME	AB1267	1
B		SWIVEL ASSEMBLY & BASE	AB1268	1
C		5/16" X 43 MM BOLT	HW0450	4
D		Ø8.0 X 2.3 MM SPRING WASHER	HW0003	4
E		METAL PLATE	HW0686	2
F		5/16" NUT	HW0015	4
G		BOLT COVER	HW0028	4
H		NUT COVER	HW0109	4
I		Ø8.5 X 1.5 MM WASHER	HW0005	4
J		HEX WRENCH-1	HW0008	1
K		HEX WRENCH-2	HW0007	1
		FOOTREST COVER <i>FACTORY ASSEMBLY</i>	G0304	
		FOOT CAP <i>FACTORY ASSEMBLY</i>	FC0030	

AA08011

ASSEMBLY INSTRUCTIONS



CSA Model WT17YP4
ARX13200

Installer: Leave these instructions with consumer.

Consumer: Keep these instructions for future reference.



DANGER

If you smell gas:

1. Shut off gas to the appliance.
2. Extinguish any open flame.
3. If odor continues, keep away from the appliance and immediately call your gas supplier or fire department.



WARNING:

Improper installation, adjustment alteration, service or maintenance can cause injury or property damage. Read the installation, operating and maintenance instructions thoroughly before installing or servicing this equipment.



WARNING

Do not store or use gasoline or other flammable vapors and liquids in the vicinity of this or any other appliance. An LP-cylinder not connected for use shall not be stored in the vicinity of this or any other appliance.



WARNING: For Outdoor Use Only

FOR USE WITH 20LB (9KG) PROPANE CYLINDER WITH TYPE 1 CONNECTION OR FOR USE WITH NATURAL GAS AFTER CONVERSION KIT IS INSTALLED (MUST BE PROFESSIONALLY INSTALLED).



DANGER

CARBON MONOXIDE HAZARD



This appliance can produce carbon monoxide which has no odor.

Using it in an enclosed space can kill you.

Never use this appliance in an enclosed space such as a camper, tent, car or home.

WARNING:

USE FACTORY APPROVED REPLACEMENT PARTS AND ACCESSORIES ONLY. USE OF UNAPPROVED PARTS OR ACCESSORIES CAN VOID THE WARRANTY ON THIS PRODUCT AND RESULT IN A HAZARDOUS CONDITION. PLEASE CONTACT US FOR INFORMATION REGARDING REPLACEMENT HOSES, THERMOCOUPLES, ELECTRODES, IGNITION MODULES, LAVAROCKS, LOGS, FIRE ICE, ETC.



Questions, Problems, Missing Parts? Before returning to your retailer, call our customer service department in the US and Canada at 1-800-416-3511, Monday-Friday, 9 a.m. – 5 p.m. Eastern Time.

TABLE OF CONTENTS

Important Safety Information	3
Important Information about Propane	4
Specification	4
Parts Identification List	5
Installation	6-7
Natural Gas Conversion	8-9
Maintenance	9
Batteries	10
Lighting Instructions	10-11
Troubleshooting Guide	11
Warranty	12

IMPORTANT SAFETY INFORMATION

The installation must conform with local codes or, in the absence of local codes, with the National Fuel Gas Code, ANSI Z223.1/NFPA 54; International Fuel Gas Code. ; Natural Gas and Propane Installation Code, CSA B149.1; or Propane Storage and Handling Code, B149.2, as applicable.

The appliance and its appliance main gas valve must be disconnected from the gas supply piping system during any pressure testing of that system at test pressures in excess of 1/2 psi (3.5kPa).

The appliance must be isolated from the gas supply piping system by closing its equipment shutoff valve during any pressure testing of the gas supply system at test pressure equal to or less than 1/2 psi (3.5kPa).

The appliance area must be kept clear and free from combustible materials, gasoline and other flammable vapors and liquids.

Do not use this appliance if any part has been under water. Immediately call a qualified service technician to inspect the appliance and to replace any part of the control system and any gas control which has been under water.

Children and adults should be alerted to the hazards of high surface temperatures and kept at a safe distance to avoid burns or clothing ignition.

Young children should be carefully supervised when they are anywhere near the appliance.

Clothing or other flammable material should not be hung from the appliance, or placed on or near the appliance.

Any screen or guard removed for servicing an appliance must be replaced prior to operating the appliance.

Installation and repair should be done by a qualified service person. The appliance should be inspected before use and at least annually by a professional service person. More frequent cleaning may be required as necessary. It is imperative that the control compartments, burners and circulating air passageways of the appliance be kept clean.

Do NOT burn solid fuels in this gas fireplace.

Do NOT ignite the burner before pouring all of the burner media (lava rock or fire ice) into the burner pan. The media must be evenly distributed over the burner.

During initial firing of firepit, please stay away from the firepit for 20 minutes as fire media (lava rock or fire ice) may pop and hit someone on the face or eyes

Do NOT ignite or use the firepit if the burner media (lava rock or fire ice) are wet. Ensure the burner media are completely dry before igniting as intense heat could cause the media to crack and pop.

It is UNSAFE to use this product for cooking!

CAUTION: The propane gas pressure regulator provided with this appliance must be used. This regulator is set for an outlet pressure of 11 inches water column.

This outdoor gas appliance is not intended to be installed in or on recreational vehicles and/or boats.

Before each use of this gas appliance, open the LP (Liquid Propane) Tank Drawer and inspect the LP Hose. If there is evidence of excessive abrasion or wear, or the hose is cut, it must be replaced prior to the gas appliance being put into operation. Use only the replacement hose assembly specified in this manual. Inspect the burner before each use of the appliance. The burner must be replaced prior to the appliance being put into operation if it is evident that the burner is damaged. Use only the burner listed in these instructions.

Keep the fuel supply hose away from any heated surfaces.

IMPORTANT SAFETY INFORMATION ABOUT PROPANE (LP) GAS

A LP-gas cylinder for use with this appliance must have a capacity of 20 lbs / 9kg. and must be equipped with a Type 1 connector and an OPD (overfill protection device). Figure 1

The LP-gas supply cylinder to be used must be constructed and marked in accordance with the specification for LP-gas cylinders of the U.S. Department of Transportation (DOT) or the National Standard of Canada, *CAN/CSA-B339, Cylinder, Sphere and Tubes for the Transportation of Dangerous Goods*.

- The cylinder supply system must be arranged for vapor withdrawal.
- The cylinder used must include a collar to protect the cylinder valve.
- This appliance shall be used only outdoors in a well-ventilated space and shall not be used in a building, garage or any other enclosed space.
- When this appliance is not in use, the gas must be turned off at the supply cylinder.
- Storage of this appliance indoors is permissible only if the cylinder is disconnected and removed from the appliance.
- Cylinders must be stored outdoors in a well-ventilated area out of the reach of children. Disconnected cylinders must have threaded valve plugs tightly installed and must not be stored in a building, garage or any other enclosed areas.

CSA (Canadian Standards Association) certified to ANSI Z21.97-2014 / CSA 2.41-2014 "Outdoor Decorative Gas Appliances"

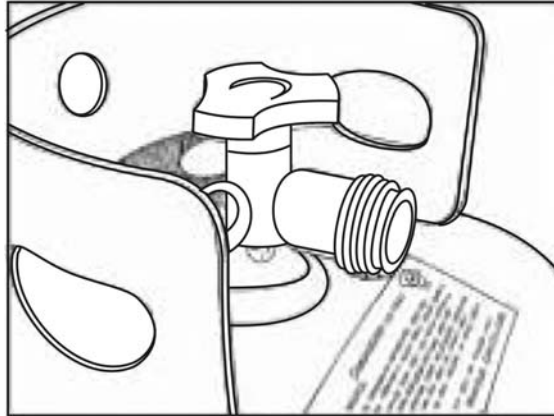























Figure 1

SPECIFICATIONS

INPUT	40,000 Btu/hr	
Propane Regulator Pressure	11 in / 2.74 kPa water column	
Natural Gas Minimum Inlet Pressure	7 in / 1.74 kPa water column	
Clearances to combustable surfaces	Sides 24 in / 60.96 cm	Top: 72 in / 182.88 cm

PARTS IDENTIFICATION LIST

	PART	DESCRIPTION	PART#	QTY
A		CONTROL PANEL	FP2187	1
B		LP REGULATOR HOSE	FP1916	1
C		LP TANK RETAINING KNOB	FP0585	2
D		ADJUSTABLE FOOT CAPS	FC0553	4
E		PROPANE ORIFICE	FP2205	1
F		NATURAL GAS ORIFICE	FP2206	1
G		FIRE ICE	FP2006	1
H		AIR SHUTTER	FP1922	1
I		1/4" X20 MM BOLT	HW0036	4
J		1/4" X30 MM BOLT	HW0038	12
K		Ø6.5 X 1.0 MM WASHER	HW0594	12
L		Ø20 X Ø6.5 X 2 MM WASHER	HW0901	4
M		HEX BOLT DRIVER	HW0006	1
N		"AAA" BATTERY(1.5V)	HW0705	1
O		FIREPIT TABLE TOP	FP2188	1
P		DOOR PANEL	FP2189	1
Q		SIDE PANEL-1	FP2190	1
R		SIDE PANEL-2	FP2191	1
S		BACK PANEL	FP2192	1
T		TOP FRAME	FP2193	1
U		BOTTOM FRAME	FP2194	1

V		BURNER COVER	FP2221	1
---	---	--------------	--------	---

INSTALLATION

1. Carefully unpack all items from the box. Place the base in the final position. There must be a minimum of 24 in / 60.96 cm of clearance from the side of the table top to any combustible walls.

2. Attach the bottom frame to the two side panels and the back panel by using six 1/4"x30 mm bolts and washers as shown in Figure 2a. Guide the bolts through the holes in the bottom frame, into the pre-drilled holes in two side panels and the back panel. Do not over tighten. Repeat for the top frame as shown in Figure 2b.

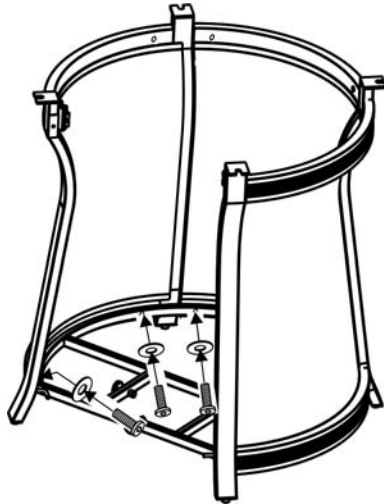

Figure 2a

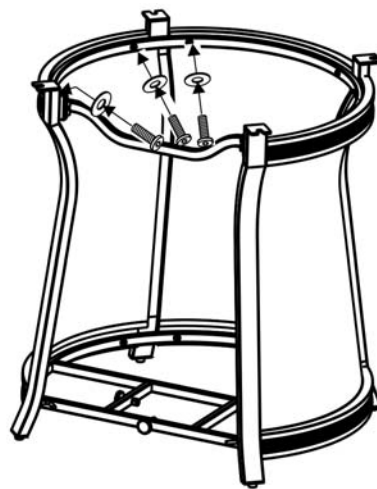

Figure 2b

3. Place the tabletop onto the firepit base. Secure the tabletop to the firepit base by using the four 1/4"x20 mm bolts and washers that are provided. See Figure 3.

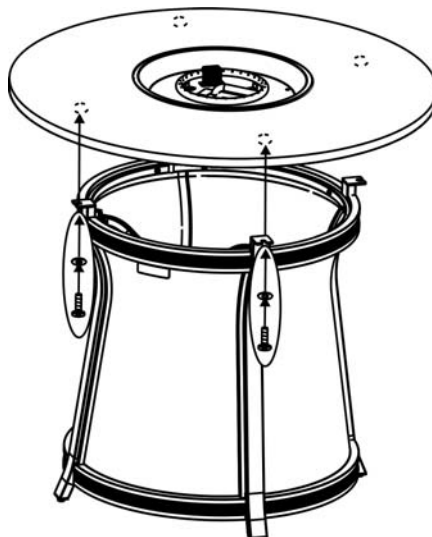

Figure 3

4. Pour the lava rocks or fire ice into the burner pan completely covering the burner. The weight of lava rocks is (3.6kg plus and minus 10%); the weight of the fire ice is (8kg plus and minus 10%). Remove any lava rocks or fire ice on top of the ignition well. See Figure 4.

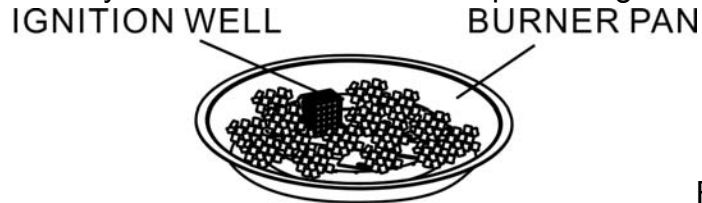

Figure 4

5. Remove the door panel and place the LP tank onto the bottom frame as shown in Figure 4. Connect the regulator as shown in Figure 4. Turn the black handle clockwise to tighten. Turn the handle counterclockwise to remove. The hose must point down. Check that the valve is turned all the way clockwise to the "OFF" position. Open the tank valve. Apply a solution of soapy water to the tank-regulator connection and to the valve-hose connection to check for leaks. If soap bubbles continue to form, the connection has a leak. If a leak is found, close the tank valve and tighten all connections.

NEVER USE A FLAME TO CHECK FOR LEAKS.

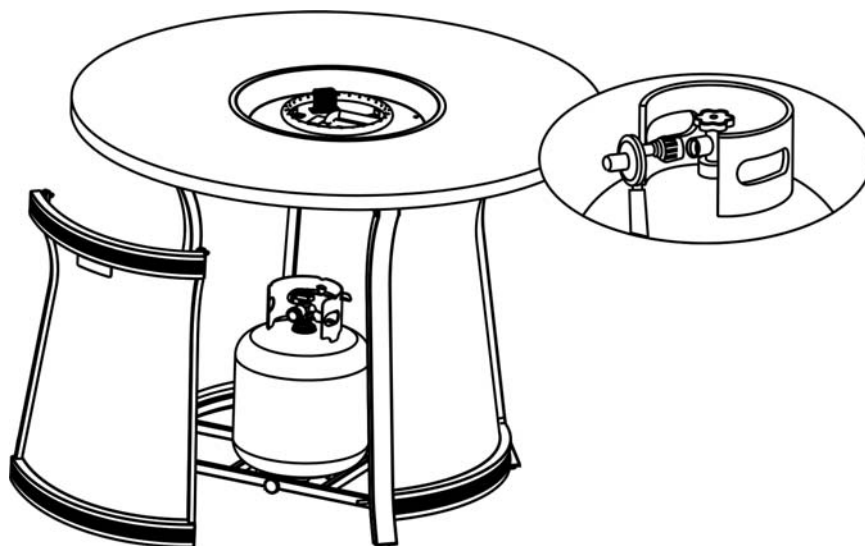

Figure 4

6. Tighten the threaded knobs found on the tank tray (Figure 5) so that the LP tank cannot move from side to side. Do not remove the plastic cap from the end of the threaded section.

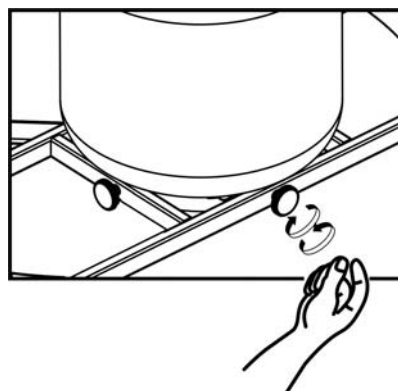

Figure 5



NATURAL GAS CONVERSION



Natural gas conversion must be performed only by your natural gas provider or service company.

1. SHUT OFF THE GAS SUPPLY TO THE UNIT AND ANY NEARBY ELECTRICAL SOURCE OR APPLIANCES

2. Below the burner, carefully disconnect flex connector attached to the orifice holder (see step1).

3. Carefully unscrew the orifice holder from the burner pipe (see step2).

4. Remove the propane orifice from the holder and replace with natural gas orifice (see step2).

5. Install the air shutter over burner pipe to cover the air holes. Then reattach orifice holder to burner pipe (see step3).

6. Reattach the flex connector to orifice holder. (see step4).

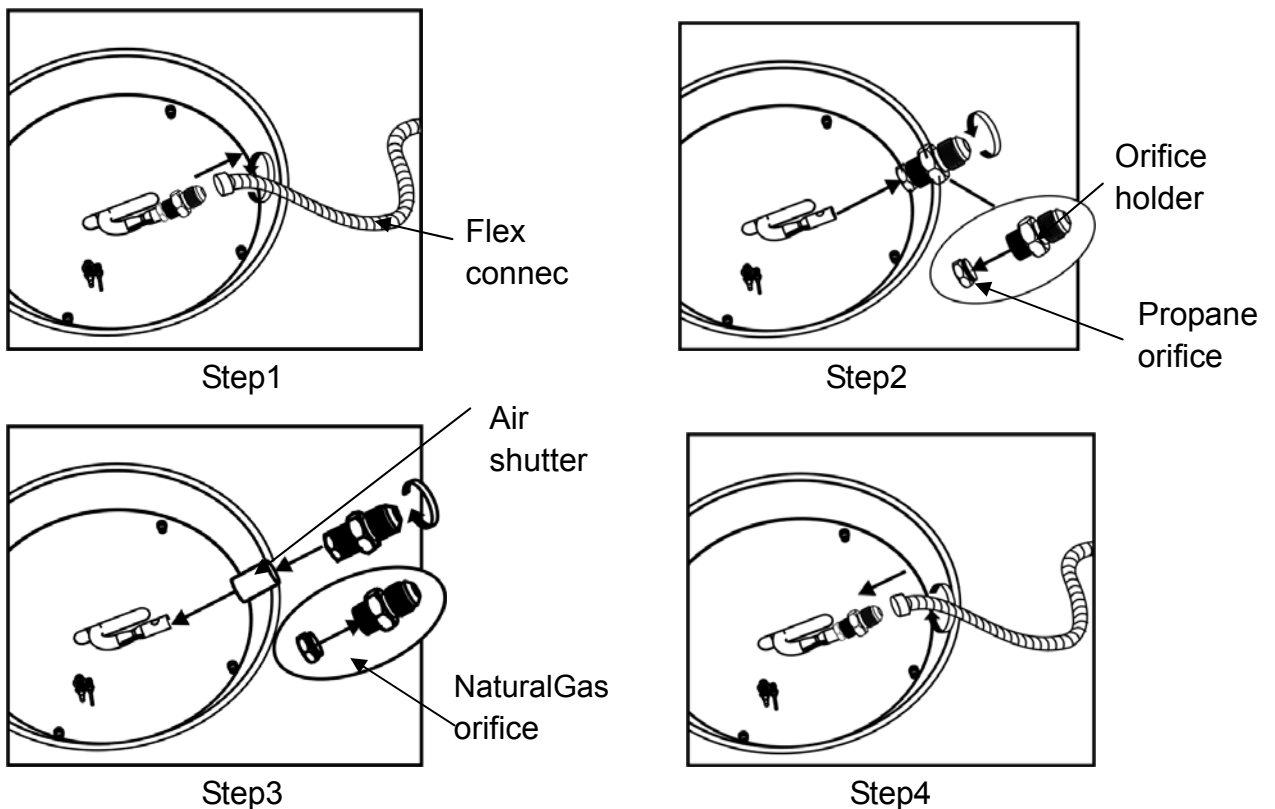

7. To convert the regulator from propane to natural gas the appliance must be isolated from the gas supply piping system by closing its individual manual shut off valve. Ensure any pressure testing of the gas supply piping system is at test pressure equal to or less than 1/2 psi(3.5KPA)

8. Remove the propane rubber hose from valve and replace with 5/8" natural gas pipe (see step5, natural gas pipe package is not provided).

9. Restore your gas supply and check ALL of the connections for leaks using a solution of soapy water. If a leak is discovered and any bubbles are seen, close the main gas valve and re-tighten ALL the connections. NEVER USE A FLAME TO CHECK FOR GAS LEAKS!

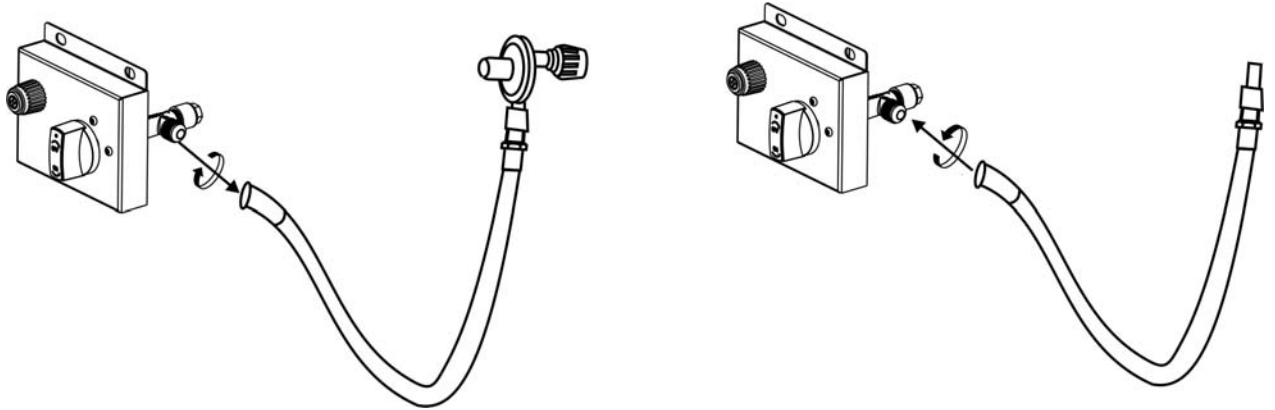

Step5

10. Stick the conversion label on the rating plate as shown in Figure 6.

Metal Rating Plate

Serial Number _____	Model Number: WT17YP4
CAUTION: The gas pressure regulator provided with this appliance must be used. This regulator is set for an outlet pressure of	
<div style="border: 1px solid black; padding: 5px;"> <p>This appliance has been converted to use Natural Gas. Input 40,000 Btu/hr. Max Gas Supply Pressure 7 inch w.c. (1.74 kPa) Min. Gas Supply Pressure 5 inch w.c. (1.24 kPa)</p> </div>	
Minimum clearance from combustible constructions: Sides: 24 in.609 mm. Top 72 in. 1828 mm.	
FOR OUTDOOR USE ONLY. If stored indoors, detach and leave cylinder outdoors.	
<div style="border: 1px solid black; padding: 5px;"> <p>⚠ WARNING: Improper installation, adjustment alteration, service or maintenance can cause injury or property damage. Refer to the owner's information manual provided with this appliance. For assistance, or additional information, consult a qualified installer, service agency, or the gas supplier.</p> </div>	

Figure 6

Conversion Label

MAINTENANCE

The flames should look like those in Figure 7. To clean the burner, use a soft brush after the burner has cooled completely. Never use a vacuum cleaner on the burner. It is recommended to store the fire pit indoors during winter if it will be subjected to freezing temperatures. The LP cylinder must be disconnected and removed from the appliance before the appliance can be stored indoors.



Figure 7

BATTERIES

Make sure the control knob is in the "OFF" position. Unscrew the push button cap on the ignition module located on the control panel to access the battery compartment. The ignition module requires one Alkaline AAA size battery (1.5V). The negative (-) end goes in first. See Figure 8. Dispose of battery safely. May explode or leak if charged or disposed of in fire. Make sure of the polarity. Mercury and cadmium free.

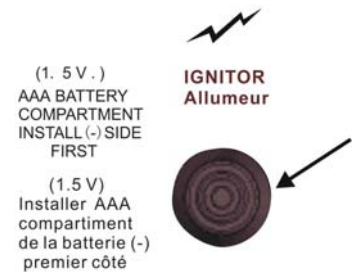

Figure 8

CAUTIONS: BATTERY INSTRUCTIONS

- Always purchase the correct size and grade of battery most suitable for the intended use.
- Clean the battery contacts and also those of the device prior to battery installation.
- Ensure the battery is installed correctly with regard to polarity (+ and -).
- Remove battery from equipment which is not to be used for an extended period of time.
- Remove used battery promptly.

For recycling and disposal of batteries to protect the environment, please check the internet or your local phone directory for local recycling centers and / or follow local government regulations.

LIGHTING INSTRUCTIONS

Warning: If these instructions are not followed exactly, a fire or explosion may result causing property damage, personal injury, or loss of life.

1. Open the tank drawer and find the control panel on the left. Make sure the control knob is in the "OFF" position. See Figure 9. Open the tank valve all the way.

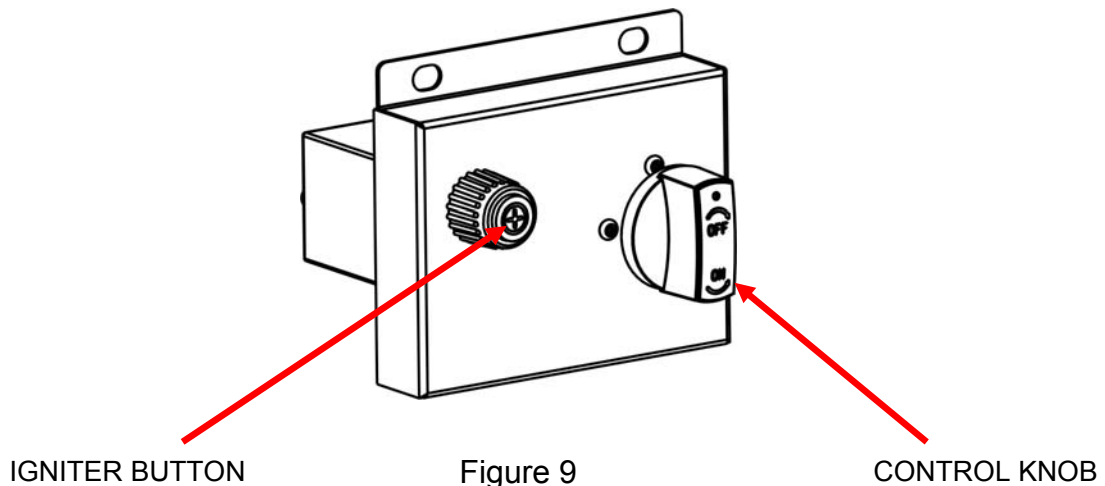

2. Push in the igniter button. You will hear a slight clicking sound. With the igniter button pushed in, push and turn the control knob to the "ON" position. The fire should light within a few seconds. Once the flame is lit, release the igniter button and continue to hold the control knob in for 10 to 15 seconds. Release the control knob. The control knob

should pop back out and then the fire remain lit. Note: If the fire does not light, turn the knob to the “OFF” position and wait five (5) minutes before trying again.

3. To turn down the flame, push the control knob in slightly and turn to Medium (medium flame), or Low (small flame).
4. To shut down the fire pit, turn the control knob to the “OFF” position and turn off the tank valve.

TROUBLESHOOTING GUIDE

PROBLEM	CAUSE	REMEDY
Burner won't light	No Propane Gas at Burner	Check that gas tank valve is open. Turn control knob to “ON” and push control knob in. Make sure tank has propane gas.
	No Spark at Electrode	Check that AAA battery is installed with negative (-) end first and has a charge. Check that the wire is connected to the ignition module. Check that the electrode is not cracked or broken.
	Lack of oxygen	Remove excess lava rocks or fire ice from around the ignition well.
Burner won't stay lit after lighting	Thermocouple not in flame	Check that the tip of the thermocouple is even with the top of the ignition well. Remove any lava rocks or fire ice from the ignition well.
	Thermocouple connection at the main control valve is loose	Tighten the thermocouple nut at the back of the valve.
	No lava rocks or fire ice on burner	Cover the burner with lava rocks or fire ice per the instructions.

ONE-YEAR LIMITED WARRANTY

What is Covered Under This Warranty?

The item you have purchased is warranted against defects in material and workmanship for the following parts from the date of purchase for the period of warranty as outlined below, but only when the unit is installed and operated in accordance with the instructions in this Owner's Manual and in compliance with local building and fire codes:

Limited 1 Year

- Stainless Tube/Plate burner

Limited 90 days

- All remaining parts

How Do I Obtain Warranty Service?

To obtain warranty service, you must contact our customer service center within the relevant warranty period and provide us with a copy of your dated register receipt as proof of the purchase date. We reserve the right to request photographs and/or return of the defective item(s) and/or such other evidence relating to any claim as we shall reasonably require. Please call our customer service center at 1-800-416-3511 for additional warranty claim details and procedures.

What are the Limitations and Exclusions of this Warranty?

Warranty Limitations:

This warranty is subject to the limitation set forth above. In addition, this warranty is made to the original purchaser only and is effective only if items are purchased from one of our authorized dealers. This warranty is not transferable. For warranty replacements based on warranty claims, we will not be responsible for charges associated with shipments outside continental North America at any time or for any reason.

Warranty Exclusions: This warranty is subject to the exclusions set forth above. In addition, the following are excluded from coverage under this warranty: any item used for commercial, contract or any other non-residential purpose; clearance items, display models or items purchased "as is"; freight damage; items subject to misuse, abuse, neglect or lack of proper care or maintenance (including without limitation as provided in any "care and maintenance guide" or similar information we provide); normal wear and tear; damage caused by acts of nature, acts of force majeure, vandalism, fire or other casualty, or improper assembly; hardware against corrosion or rusting; purchased or replacement parts; and all plastic parts. Also excluded are loss of use or time; inconvenience; money; travel; packaging; or incidental, special or consequential damages of any kind. Replacement of defective items or parts as provided herein, or (at our sole discretion) pro rated refund of your purchase price, shall constitute your sole and exclusive remedy for items which are not as warranted. In no event shall our responsibility exceed the purchase price of the item found to be other than as warranted. This warranty is the exclusive statement of your rights with respect to items you have purchased and supersedes any other express warranty or statement, written or oral, made in connection with the purchase and sale of such items. The term "item" when used herein in the singular refers to the specific piece found to be defective, and not to the entire set of which the item is a part.

Some states do not allow exclusion or limitation of incidental or consequential damage, so that limitation may not apply to you. This warranty gives you specific legal rights, and you may also have other rights that vary from state to state.