

# Outdoor Furniture



## IMPORTANT

If you have any problems with this product (missing or damaged parts, assembly issues, etc.),

**PLEASE DO NOT RETURN TO THE RETAILER/STORE**

from where you purchased the product.

Please call our Toll-Free Customer Service Hotline at: **1-800-416-3511**

Between 9:00 AM and 5:00 PM Eastern Time, Monday through Friday.

To expedite any future warranty claims, please retain the Instruction Sheet, Warranty Card, and Receipt for future use.

### Care and Maintenance

Store furniture in an upright position. Be careful to never allow water to build up in frames as this will cause corrosion and freeze damage in cold climates. Wash all frames with a solution of mild soap and water. Rinse with clean water and dry with a soft absorbent cloth towel. Frames can be treated with a liquid wax for maximum protection against UV rays and/or salty, damp air. If your set includes cushions, slings, and/or an umbrella they may be cleaned by hand with a solution of soap and water with a clean water rinse. (Never machine wash cushions, slings or umbrella covers as this will result in shrinkage or damage). After cleaning cushions tip on end and allow to drip dry. (Never use a commercial or home dryer to tumble dry fabric goods). Do not use bleach or solvents to clean any of the product! This will void the warranty.

# Care & Maintenance

*Outdoor furniture can be enjoyed for many years when well maintained.*

## **Regular Maintenance**

Wash the furniture with a solution of mild detergent and water, rinse with clear water, and dry thoroughly. To all metal frames, apply a fine, clear automobile wax for maximum protection against harmful ultraviolet exposure and salt air.

For best protection, perform this maintenance two or three times per year in low pollution areas or more frequently in high pollution areas. Please note that these durable materials can be safely cleaned as often as desired. Note: Some suntan and sun block products may be harmful to resin, cushions and strap, mesh and vinyl lace and strap. Do not allow such products to come in contact with any seating surfaces to avoid deep penetrating stains, which are not covered under warranty.

## **How to Clean & Care for Teak Furnishings**

Left alone to age, the natural color of teak furnishings will weather to a soft, silver grey. This process will take approximately nine months, depending on the degree of sunlight and rain exposure. Imperfections, which are inherent properties of the wood, will show over time, enhancing the beauty of the furniture. In humid or wet climates, or after rains, the wood may naturally expand and contract, causing the grain to rise. This is to be expected with exposure to the elements and will stabilize after the initial weathering occurs. To maintain teak furnishings, use a soft bristled utility brush and stroke lightly in the direction of the grain to remove surface dust. For more stubborn dirt, the wood may be washed with a mild solution of four parts laundry detergent or dish washing soap to one part bleach in water, then rinsed thoroughly and allowed to dry completely. Oiling the wood may cause mildew or irregular coloring.

## **How to Clean Woven Furnishings**

Woven furnishings are made of durable and weatherproof extruded polyethylene resin weave. Light stains and soils may be removed with a solution of mild detergent and water, rinsed with clear water and dried thoroughly. Mildew and heavy stains can be removed with a quality commercial outdoor furniture cleaner and protectant. Woven furnishings may not be suitable for intensely hot climates.

## **How to Clean Fabric**

Fine outdoor fabrics are designed to endure years of sun, soil and moisture. Wash outdoor cushions with a solution of mild detergent and water and thoroughly rinse with clear water. Stand cushions on end and allow to air dry completely. Light stains can be removed as above. Mildew and heavy stains can be removed with a quality commercial outdoor furniture cleaner and protectant. Note: Do not dry clean or use a washing machine or dryer. Do not steam or use water at temperatures above 100° F when washing. Note: Be careful to keep the outdoor furniture cleaner from contact with the cushions of your outdoor furniture, as it will cause discoloration. Do not use bleach on printed acrylic fabrics. Do not use solvent-type materials on woven vinyl, woven blend or ultra woven blend fabrics as they will damage the yarns. Do not use chlorine based cleaners.

## **How to Clean Mesh**

Remove light stains with a solution of mild detergent and water, then rinse with clear water and dry thoroughly. Mildew and heavy stains can be removed with a quality commercial outdoor furniture cleaner and protectant.

## **How to Clean Strap**

For general or light cleaning, begin by brushing dirt off the strap. Apply a solution of mild detergent and warm water and allow it to soak into the strap. Gently clean with a sponge or soft bristle brush, then rinse thoroughly with clear water and allow the strap to air dry.

## **How to Clean Vinyl Strap**

Apply a quality vinyl protectant to guard against the effects of air pollution, salt air build-up, and mildew. To remove difficult stains use rubbing alcohol applied with a soft cloth.

## **How to Clean & Care for Stone and Marble Tops**

Tabletops are designed for normal outdoor use in residential settings. To maintain the natural beauty we recommend resealing your table top when necessary, with the same sealer product applied during the manufacturing process. The sealer penetrates the stone and acts as a repellent, preventing absorption of moisture and stainable materials.

If tabletop is stained with products such as wine, soda, coffee, or other colorants of organic origin, clean these spills immediately with a mild detergent then rinse with water. In extreme cold climates, it is recommended that tabletops be stored in a dry indoor area or be covered with suitable outdoor furniture cover. Be sure to allow space between the tabletop and the cover so that moisture does not collect on the table; this will promote airflow and allow moisture to escape.

## ASSEMBLY INSTRUCTIONS

- 1 Attach a table leg to the leg connector bracket by using a 1/4"x15 mm bolt and washer as shown in **Figure 1**. Guide the bolt through the hole in the leg connector bracket, into the pre-drilled hole in the leg. **Hand tighten only 2-3 turns**. Repeat for the other three legs.

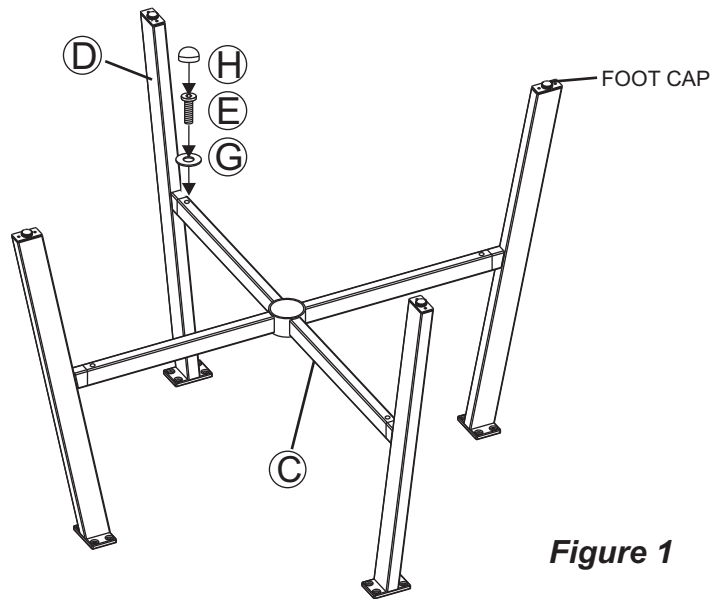

**Figure 1**

- 2 Place the table rim upside down on a flat, non-abrasive surface. Attach a table leg to the table rim by using four 1/4"x20 mm bolts and washers as shown in **Figure 2**. Guide the bolts through the holes in the table leg into the pre-drilled holes in the table rim. **Hand tighten only 2-3 turns**. Repeat for the other three legs.

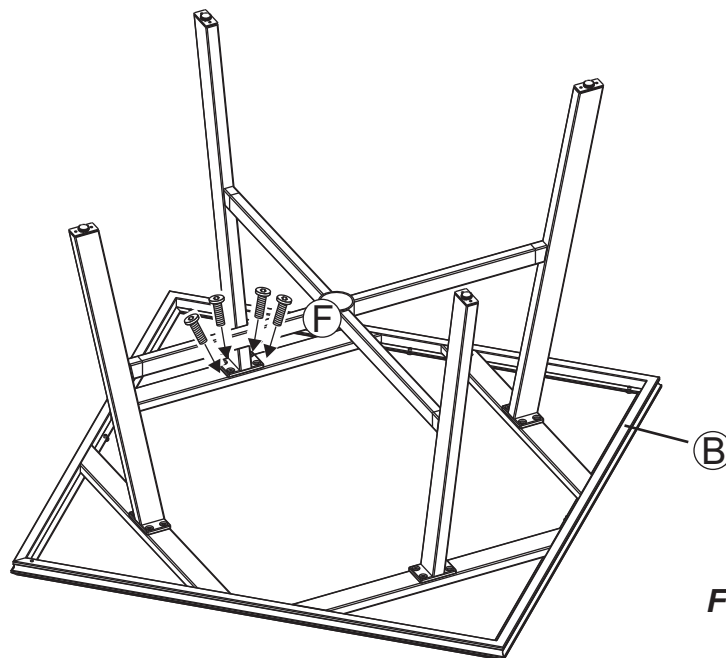
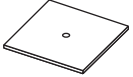

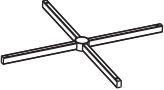











**Figure 2**

- 3 After making any necessary adjustments to the alignment of the table, use the hex bolt driver to tighten all bolts. Repeat until all bolts are tight. **Do not over tighten**. Over tightening may strip bolts.
- 4 With the help of another person, turn the table in the upright position. Note the clear bumpers spaced evenly throughout the inside of the table rim. Carefully place table glass inside the table rim, resting on the clear bumpers.

# PARTS IDENTIFICATION LIST

\* NOTE: PARTS SHOWN ON PARTS LIST ARE NOT TO SCALE

	<u>PARTS LIST</u>	<u>DESCRIPTION</u>	<u>ORDER PART #</u>	<u>QTY</u>
A		GLASS TOP		1
B		TABLE RIM	AT10299	1
C		LEG CONNECTOR BRACKET	AT10300	1
D		TABLE LEG	AT10301	4
E		1/4" X 15 MM BOLT	HW0034	4
F		1/4" X 20 MM BOLT	HW0036	16
G		Ø6.5 X 1.0 MM WASHER	HW0004	4
H		BOLT COVER	HW0105	4
I		HEX BOLT DRIVER	HW0006	1
		TABLE BUMPER FACTORY ASSEMBLY	G0217	
		TABLE BUMPER FACTORY ASSEMBLY	G0199	
		FOOT CAP FACTORY ASSEMBLY	FC0757	
		UMBRELLA CAP AND RING SET FACTORY ASSEMBLY	G0004	

ALE19910