

Outdoor Furniture



IMPORTANT

If you have any problems with this product (missing or damaged parts, assembly issues, etc.),

PLEASE DO NOT RETURN TO THE RETAILER/STORE

from where you purchased the product.

Please call our Toll-Free Customer Service Hotline at: **1-800-416-3511**

Between 9:00 AM and 5:00 PM Eastern Time, Monday through Friday

To expedite any future warranty claims, please retain the Instruction Sheet, Warranty Card and receipt for future use.

Care and Maintenance

Store furniture in an upright position. Be careful to never allow water to build up in frames as this will cause corrosion and freeze damage in cold climates. Wash all frames with a solution of mild soap and water. Rinse with clean water and dry with a soft absorbent cloth towel. Frames can be treated with a liquid wax for maximum protection against UV rays and/or salty, damp air. If your set includes cushions, slings, and/or an umbrella they may be cleaned by hand with a solution of soap and water with a clean water rinse. (Never machine wash cushions, slings or umbrella covers as this will result in shrinkage or damage). After cleaning cushions tip on end and allow to drip dry. (Never use a commercial or home dryer to tumble dry fabric goods). Do not use bleach or solvents to clean any product! This will void the warranty.

Outdoor Furniture

1-Year Limited Warranty Program

For a period of one (1) year after purchase, the Manufacturer will either repair or replace defective components in accordance with this Limited Warranty. This warranty is between Manufacturer and the original purchaser and is valid only when accompanied by the original purchaser's sales receipt showing original date of purchase and location of purchase. Replacements under this warranty revert back to the date of original purchase for future warranty.

Manufacturer or its authorized dealer can accept or reject warranty claims based on its findings. This warranty applies in normal residential use only and is not intended for commercial use. Manufacturer can make substitutions as required of materials, components, and sub-components of comparable value and utility. This warranty is limited to product repair or replacement (to be determined solely by Manufacturer). Warranty return is limited to only the single affected component.

This warranty covers only manufacturing defects and does not cover normal wear and tear, damage due to acts of nature (such as, but not limited to freezing or high winds), abuse or misuse, including chemical damage from suntan oil or other chemicals, exposure to extreme heat or cold, abrasion or excessive weight. This product is intended to be used in standard installations only. This warranty is invalid if the product is not used for intended purpose. Manufacturer disclaims liability for any aspect of installation and any inconvenience caused by a defective part of a component.

Certain items are not covered by this warranty. These include, but are not limited to the following:

1. Components subjected to abuse, including abuse intended to simulate failure.
2. Damages caused by retailer, shipper or installation crew (such as scratches, dents, tears, chips, etc.).
3. Any part which merely exhibits normal wear yet functions essentially as new, including chips, scratches or stretching of materials and stitching.
4. Tears, punctures, scratches or any damage caused by improper installation or use.
5. Damage to frames/welds resulting from improper assembly or exposure to water and/or sub-freezing temperatures is not covered. General frame rusting is not covered.
6. Fading and/or discoloration of fabrics/cushions/straps/wicker resulting from exposure to the elements, chemicals, oils, fluids or any other cause are not covered.
7. Umbrella bases are not covered under any circumstances.
8. Items sold "as is" or floor models.

To make a claim, call the toll-free number below. Please have available a copy of the original sales receipt along with a brief description of the problem. Please also provide your email address and daytime telephone or cell phone #. Repairs or replacement will be made at the Manufacturer's option. *Sales and use taxes, plus shipping and handling charges are the responsibility of the consumer.*

THIS IS THE ENTIRE EXCLUSIVE EXPRESS LIMITED LIABILITY. THE MANUFACTURER NEITHER MAKES NOR IS RESPONSIBLE FOR ANY OTHER WARRANTIES, EITHER EXPRESS OR IMPLIED, INCLUDING THOSE OF RETAILING DEALERS. THIS EXCLUSIVE REMEDY IS LIMITED TO RECEIPT OF A CREDIT IN CONNECTION WITH THE REPAIR OR REPLACEMENT OF ANY PRODUCT OR COMPONENT DEEMED TO BE DEFECTIVE UNDER THE TERMS AND CONDITIONS AS STATED IN THIS WARRANTY. NEITHER THE PRODUCT MANUFACTURER NOR ITS AGENTS SHALL BE LIABLE IN ANY CASE FOR INCIDENTAL, INDIRECT, SPECIAL OR CONSEQUENTIAL DAMAGES RESULTING FROM THE USE OF THIS PRODUCT OR ARISING OUT OF ANY BREACH OF THIS WARRANTY OR NEGLIGENCE EVEN IF IT HAS BEEN ADVISED OF THE POSSIBILITY OF SUCH DAMAGES. EXCEPT AS OTHERWISE MAY BE REQUIRED BY LAW, THERE ARE NO OTHER EXPRESS OR IMPLIED WARRANTIES OTHER THAN THE WARRANTY DESCRIBED HEREIN, AND ALL OTHER WARRANTIES, INCLUDING ANY IMPLIED WARRANTY OF

Contact Warranty Services at **1-800-416-3511**

Care & Maintenance

Outdoor furniture can be enjoyed for many years when well maintained.

Regular Maintenance

Wash the furniture with a solution of mild detergent and water, rinse with clear water, and dry thoroughly. To all metal frames, apply a fine, clear automobile wax for maximum protection against harmful ultraviolet exposure and salt air.

For best protection, perform this maintenance two or three times per year in low pollution areas or more frequently in high pollution areas. Please note that these durable materials can be safely cleaned as often as desired. Note: Some suntan and sun block products may be harmful to resin, cushions and strap, mesh and vinyl lace and strap. Do not allow such products to come in contact with any seating surfaces to avoid deep penetrating stains, which are not covered under warranty.

How to Clean & Care for Teak Furnishings

Left alone to age, the natural color of teak furnishings will weather to a soft, silver grey. This process will take approximately nine months, depending on the degree of sunlight and rain exposure. Imperfections, which are inherent properties of the wood, will show over time, enhancing the beauty of the furniture. In humid or wet climates, or after rains, the wood may naturally expand and contract, causing the grain to rise. This is to be expected with exposure to the elements and will stabilize after the initial weathering occurs. To maintain teak furnishings, use a soft bristled utility brush and stroke lightly in the direction of the grain to remove surface dust. For more stubborn dirt, the wood may be washed with a mild solution of four parts laundry detergent or dish washing soap to one part bleach in water, then rinsed thoroughly and allowed to dry completely. Oiling the wood may cause mildew or irregular coloring.

How to Clean Woven Furnishings

Woven furnishings are made of durable and weatherproof extruded polyethylene resin weave. Light stains and soils may be removed with a solution of mild detergent and water, rinsed with clear water and dried thoroughly. Mildew and heavy stains can be removed with a quality commercial outdoor furniture cleaner and protectant. Woven furnishings may not be suitable for intensely hot climates.

How to Clean Fabric

Fine outdoor fabrics are designed to endure years of sun, soil and moisture. Wash outdoor cushions with a solution of mild detergent and water and thoroughly rinse with clear water. Stand cushions on end and allow to air dry completely. Light stains can be removed as above. Mildew and heavy stains can be removed with a quality commercial outdoor furniture cleaner and protectant. Note: Do not dry clean or use a washing machine or dryer. Do not steam or use water at temperatures above 100° F when washing. Note: Be careful to keep the outdoor furniture cleaner from contact with the cushions of your outdoor furniture, as it will cause discoloration. Do not use bleach on printed acrylic fabrics. Do not use solvent-type materials on woven vinyl, woven blend or ultra woven blend fabrics as they will damage the yarns. Do not use chlorine based cleaners.

How to Clean Mesh

Remove light stains with a solution of mild detergent and water, then rinse with clear water and dry thoroughly. Mildew and heavy stains can be removed with a quality commercial outdoor furniture cleaner and protectant.

How to Clean Strap

For general or light cleaning, begin by brushing dirt off the strap. Apply a solution of mild detergent and warm water and allow it to soak into the strap. Gently clean with a sponge or soft bristle brush, then rinse thoroughly with clear water and allow the strap to air dry.

How to Clean Vinyl Strap

Apply a quality vinyl protectant to guard against the effects of air pollution, salt air build-up, and mildew. To remove difficult stains use rubbing alcohol applied with a soft cloth.

How to Clean & Care for Stone and Marble Tops

Tabletops are designed for normal outdoor use in residential settings. To maintain the natural beauty we recommend resealing your table top when necessary, with the same sealer product applied during the manufacturing process. The sealer penetrates the stone and acts as a repellent, preventing absorption of moisture and stainable materials.

If tabletop is stained with products such as wine, soda, coffee, or other colorants of organic origin, clean these spills immediately with a mild detergent then rinse with water. In extreme cold climates, it is recommended that tabletops be stored in a dry indoor area or be covered with suitable outdoor furniture cover. Be sure to allow space between the tabletop and the cover so that moisture does not collect on the table; this will promote airflow and allow moisture to escape.

ASSEMBLY INSTRUCTIONS

- 1 Assemble furniture on a smooth, non-abrasive surface. Attach the back frame to right arm by using two 1/4"x18 mm bolts and washers as shown in **Fig.1**. Guide the bolts through holes in back frame, into pre-drilled holes in the right arm. **Hand tighten only**. Attach the seat frame to right arm and back frame by using four 1/4"x18 mm bolts and washers as shown in **Fig.2**. **Hand tighten only**. Attach the left arm to back and seat frame by using four 1/4"x18 mm bolts and four washers as shown in **Fig.3**. **Hand tighten only**.

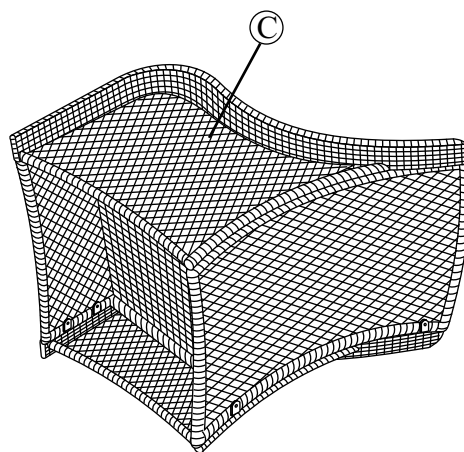
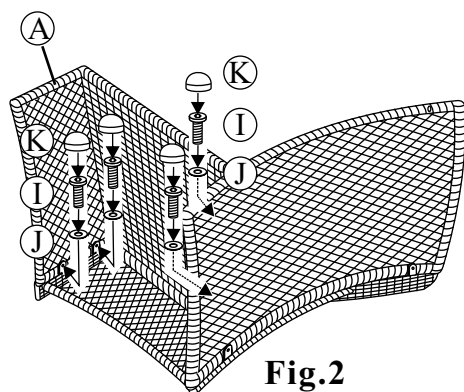
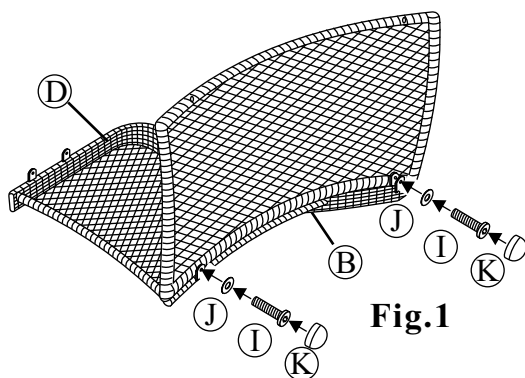

Fig.3

- 2 Attach the complete base to the complete seat by using four 5/16"x40 mm bolts and washers as shown in **Fig.4**. Guide the bolts through holes in base, into the pre-drilled holes in the seat. **Hand tighten only**.

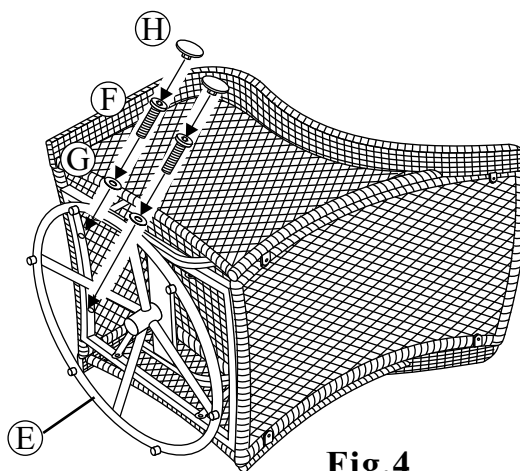



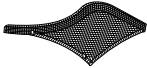

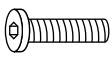





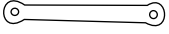



Fig.4

- 3 Using the hex bolt driver provided, tighten all bolts. **Do not over tighten bolts. If nuts and bolts are too tight or too loose, the glider will not function properly.** Test the operation of glider. Gliding motion should be smooth. Adjust tension on the glider brackets, nuts and bolts as needed. Cover nuts and bolts with covers provided.

PARTS IDENTIFICATION LIST

* NOTE: PARTS SHOWN ON PARTS LIST ARE NOT TO SCALE











	<u>PARTS LIST</u>	<u>DESCRIPTION</u>	<u>ORDER PART #</u>	<u>QTY</u>
A		SEAT FRAME	SG0154	1
B		BACK FRAME	SG0155	1
C		LEFT ARM	SG0156	1
D		RIGHT ARM	SG0157	1
E		GLIDER BASE W/ GLIDER BRACKET	SG0158 SG0159	1
F		5/16" X 40 MM BOLT	HW0275	4
G		Ø8.5 X 1.5 MM WASHER	HW0005	4
H		BOLT COVER-1	HW0022	4
I		1/4" X18 MM BOLT	HW0035	10
J		Ø6.5 X 1.0 MM WASHER	HW0004	10
K		BOLT COVER-2	HW0105	10
L		HEX BOLT DRIVER	HW0006	1
		GLIDER BRACKET <i>FACTORY ASSEMBLY</i>	G0080	
		ST4.8 X 25 BOLT <i>FACTORY ASSEMBLY</i>	HW0695	
		FOOT CAP <i>FACTORY ASSEMBLY</i>	FC0013	

BGS12023

**IMPORTANT. PLEASE READ ENTIRE INSTRUCTION SHEET BEFORE ASSEMBLY.
TO EXPEDITE ANY FUTURE WARRANTY CLAIMS, PLEASE KEEP INSTRUCTION SHEET, WARRANTY CARD AND RECEIPT**

- Step 1:** Identify all parts packed in the carton against the parts list. Remove all protective materials. If any parts are missing or damaged, call our Customer Service Center at 1-800-416-3511. **Do not attempt assembly any parts are missing or damaged.**
- Step 2:** Attach the seat frame to the back frame by using four 5/16" x 40 mm bolts and washer as shown in *Figure 1*. Guide these bolts through the holes in the seat frame, into the fixed nuts already in place in the back frame. **Do not over tighten.**
- Step 3:** Attach love seat arm by inserting two 5/16" x 25 mm bolts with washers through the holes in front seat portion of the love seat frame and into the holes in the rear portion of the love seat arm as shown in *Figure 2*. Attach back of love seat arm by inserting two 5/16" x 40 mm bolts with washers through holes in the back portion of love seat frame and into the holes in the rear portion of the love seat arm as shown in *Figure 2*. **Hand tighten only.** Repeat for the opposite side.
- Step 4:** Tighten all bolts using the hex bolt driver provided. Tighten each bolt a few revolutions at a time, alternating between bolt connections until all bolts are tight. **Do not over tighten. Over tightening may strip bolts or damage the welds or frame.** Cover all bolts with bolt covers provided.
- Step 5:** Your love seat is now ready for use. If you have any questions, please call our Customer Service Center at 1-800-416-3511.
- IMPORTANT NOTE: Damage to welds or frames resulting from over tightened bolts or improper assembly is not covered under our warranty. Please read all instructions carefully before assembly. If you have any questions regarding your assembly, call our Customer Service Center at 1-800-416-3511.**

* NOTE: PARTS SHOWN ON PARTS LIST ARE NOT TO SCALE

PARTS LIST	DESCRIPTION	ORDER PART #	QTY
	BACK FRAME	SK0939	1
	SEAT FRAME	SK0940	1
	LEFT ARM	SK0941	1
	RIGHT ARM	SK0942	1
	5/16" X 25 MM BOLT	HW0186	4
	5/16" X 40 MM BOLT	HW0275	8
	Ø8.5 X 1.5 MM WASHER	HW0005	12
	BOLT COVER	HW0022	12
	HEX BOLT DRIVER	HW0006	1
	FOOT CAP-1 FACTORY ASSEMBLY	FC0030	
	FOOT CAP-2 FACTORY ASSEMBLY	FC0308	

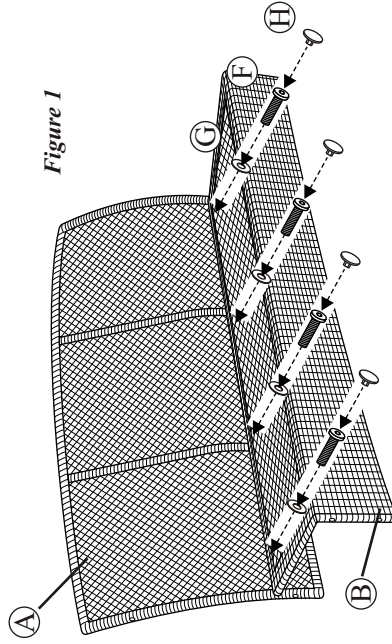

Figure 1

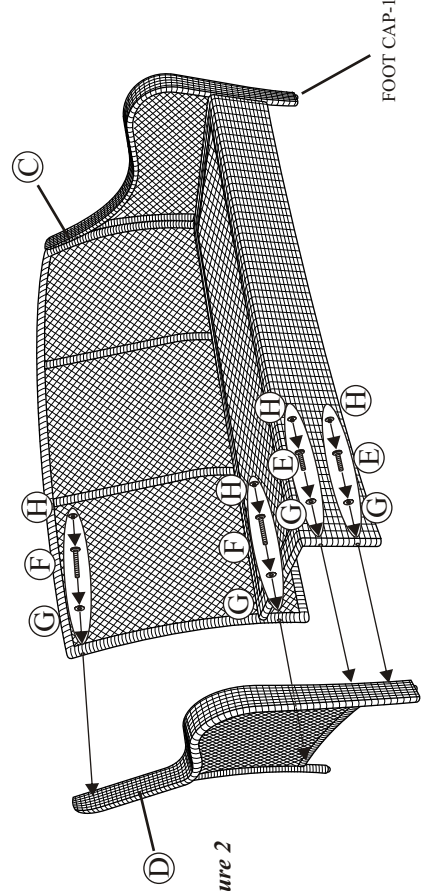

Figure 2

BGC08006

**IMPORTANT!! PLEASE READ ENTIRE INSTRUCTION SHEET BEFORE ASSEMBLY!!
TO EXPEDITE WARRANTY CLAIMS PLEASE KEEP INSTRUCTION SHEET, WARRANTY CARD AND COPY OF RECEIPT**

Step 1: Carefully remove glass and set aside until Step 5. Lay glass flat--do not stand glass on edge. Remove all protective materials and set parts on a flat, non-abrasive surface. Identify parts packed in carton against the parts list. If you are missing any parts or are unsure how to proceed with assembly, call our Customer Service Center at 1-800-416-3511. **Do not attempt assembly if any parts are missing or damaged.**

Step 2: Place the table rim (without glass) upside down on a flat, non-abrasive surface. Attach the table leg to the rim by using a 1/4"x25 mm bolt and a washer as shown in *Figure 1*. Guide the bolt through the hole in the table leg, into the pre-drilled hole in the table rim. **Do not tighten completely.** Some adjustments may be necessary to ensure proper alignment of the table legs. Repeat for the other three table legs.

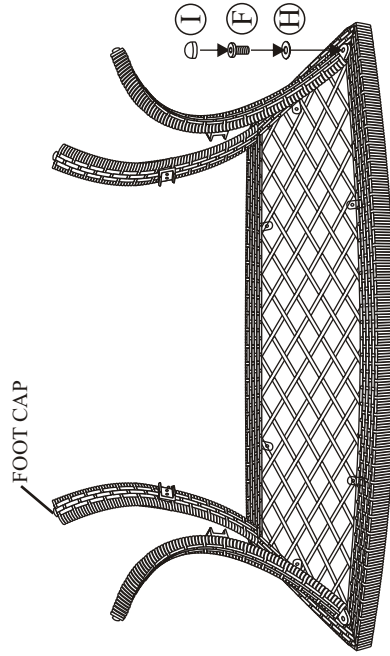

Figure 1

Step 3: Attach the leg connector bracket to the legs by using the 1/4"x35 mm bolts as shown in *Figure 2*. Add a washer to each bolt. Guide these bolts through the holes in the leg connector bracket, into the fixed nuts already in place in the legs. **Do not over tighten.**

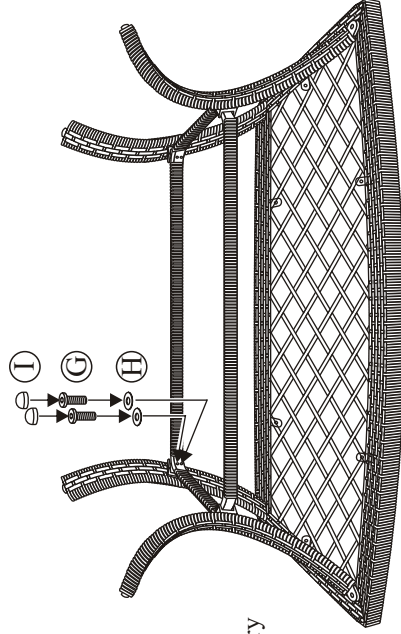

Figure 2

Step 4: After making any necessary adjustments to the alignment of the table legs and the leg connector bracket, use hex bolt driver to tighten all bolts. **Note:** Each bolt must be tightened a few revolutions at a time. In order to apply equal pressure to all bolt joints, we recommend working in a cross corner (X fashion). Repeat until all bolts are tight. **Do not over tighten.** Over tightening may strip bolts or damage the welds or frame. Cover all bolts with covers.

Step 5: With the help of another person, turn the table in the upright position. Note the clear bumpers spaced evenly throughout the inside of the rim. Carefully place glass inside the rim, resting on the clear bumpers. Your table is now ready for use. If you have any questions, please call our Customer Service Center at 1-800-416-3511.

IMPORTANT NOTE: Damage to welds or frames resulting from over tightened bolts or improper assembly is not covered under our warranty. Please read all instructions carefully before assembly. If you have any questions regarding your assembly, call our Customer Service Center at 1-800-416-3511.

** NOTE: PARTS SHOWN ON PARTS LIST ARE NOT TO SCALE*

	PARTS LIST	DESCRIPTION	ORDER PART #	QTY
A		GLASS TOP		1
B		TABLE RIM	ST1601	1
C		LEG CONNECTOR BRACKET	ST1602	1
D		TABLE LEG	ST1603	4
E		HEX BOLT DRIVER	HW0006	1
F		1/4" X 25 MM BOLT	HW0037	4
G		1/4" X 35 MM BOLT	HW0142	8
H		Ø6.5 X 1.0 MM WASHER	HW0004	12
I		BOLT COVER	HW0105	12
		BUMPER <i>FACTORY ASSEMBLY</i>	G0002	
		FOOT CAP <i>FACTORY ASSEMBLY</i>	FC0069	

BKS04310