



## Hanover Outdoor Furniture



### **IMPORTANT**

If you have any problems with this product (missing or damaged parts, assembly issues, etc.),

**PLEASE DO NOT RETURN TO THE RETAILER/STORE**

from where you purchased the product.

Please call our Toll-Free Customer Service Hotline at: **1-877-397-5144**

Between 9:00 AM and 5:00 PM Eastern Time, Monday through Friday

Or visit our website at: **[www.hanover-products.com](http://www.hanover-products.com)**

To expedite any future warranty claims, please retain the Instruction Sheet, Warranty Card and receipt for future use.

### **Care and Maintenance**

Store furniture in an upright position. Be careful to never allow water to build up in frames as this will cause corrosion and freeze damage in cold climates. Wash all frames with a solution of mild soap and water. Rinse with clean water and dry with a soft absorbent cloth towel. Frames can be treated with a liquid wax for maximum protection against UV rays and/or salty, damp air. If your set includes cushions, slings, and/or an umbrella they may be cleaned by hand with a solution of soap and water with a clean water rinse. (Never machine wash cushions, slings or umbrella covers as this will result in shrinkage or damage). After cleaning cushions tip on end and allow to drip dry. (Never use a commercial or home dryer to tumble dry fabric goods). Do not use bleach or solvents to clean any product! This will void the warranty.

For additional on-line support on assembly, troubleshooting and care & maintenance of your outdoor furniture, please visit our website at: **[www.hanover-products.com](http://www.hanover-products.com)**.

# Outdoor Furniture

## 1-Year Limited Warranty Program

For a period of one (1) year after purchase, the Manufacturer will either repair or replace defective components in accordance with this Limited Warranty. This warranty is between Manufacturer and the original purchaser and is valid only when accompanied by the original purchaser's sales receipt showing original date of purchase and location of purchase. Replacements under this warranty revert back to the date of original purchase for future warranty.

Manufacturer or its authorized dealer can accept or reject warranty claims based on its findings. This warranty applies in normal residential use only and is not intended for commercial use. Manufacturer can make substitutions as required of materials, components, and sub-components of comparable value and utility. This warranty is limited to product repair or replacement (to be determined solely by Manufacturer). Warranty return is limited to only the single affected component.

This warranty covers only manufacturing defects and does not cover normal wear and tear, damage due to acts of nature (such as, but not limited to freezing or high winds), abuse or misuse, including chemical damage from suntan oil or other chemicals, exposure to extreme heat or cold, abrasion or excessive weight. This product is intended to be used in standard installations only. This warranty is invalid if the product is not used for intended purpose. Manufacturer disclaims liability for any aspect of installation and any inconvenience caused by a defective part of a component.

Certain items are not covered by this warranty. These include, but are not limited to the following:

1. Components subjected to abuse, including abuse intended to simulate failure.
2. Damages caused by retailer, shipper or installation crew (such as scratches, dents, tears, chips, etc.).
3. Any part which merely exhibits normal wear yet functions essentially as new, including chips, scratches or stretching of materials and stitching.
4. Tears, punctures, scratches or any damage caused by improper installation or use.
5. Damage to frames/welds resulting from improper assembly or exposure to water and/or sub-freezing temperatures is not covered. General frame rusting is not covered.
6. Fading and/or discoloration of fabrics/cushions/straps/wicker resulting from exposure to the elements, chemicals, oils, fluids or any other cause are not covered.
7. Umbrella bases are not covered under any circumstances.
8. Items sold "as is" or floor models.

To make a claim, call the toll-free number below. Please have available a copy of the original sales receipt along with a brief description of the problem. Please also provide your email address and daytime telephone or cell phone #. Repairs or replacement will be made at the Manufacturer's option. *Sales and use taxes, plus shipping and handling charges are the responsibility of the consumer.*

THIS IS THE ENTIRE EXCLUSIVE EXPRESS LIMITED LIABILITY. THE MANUFACTURER NEITHER MAKES NOR IS RESPONSIBLE FOR ANY OTHER WARRANTIES, EITHER EXPRESS OR IMPLIED, INCLUDING THOSE OF RETAILING DEALERS. THIS EXCLUSIVE REMEDY IS LIMITED TO RECEIPT OF A CREDIT IN CONNECTION WITH THE REPAIR OR REPLACEMENT OF ANY PRODUCT OR COMPONENT DEEMED TO BE DEFECTIVE UNDER THE TERMS AND CONDITIONS AS STATED IN THIS WARRANTY. NEITHER THE PRODUCT MANUFACTURER NOR ITS AGENTS SHALL BE LIABLE IN ANY CASE FOR INCIDENTAL, INDIRECT, SPECIAL OR CONSEQUENTIAL DAMAGES RESULTING FROM THE USE OF THIS PRODUCT OR ARISING OUT OF ANY BREACH OF THIS WARRANTY OR NEGLIGENCE EVEN IF IT HAS BEEN ADVISED OF THE POSSIBILITY OF SUCH DAMAGES. EXCEPT AS OTHERWISE MAY BE REQUIRED BY LAW, THERE ARE NO OTHER EXPRESS OR IMPLIED WARRANTIES OTHER THAN THE WARRANTY DESCRIBED HEREIN, AND ALL OTHER WARRANTIES, INCLUDING ANY IMPLIED WARRANTY OF

Contact Warranty Services at **1-877-397-5144**

# Care & Maintenance

*Outdoor furniture can be enjoyed for many years when well maintained.*

## **Regular Maintenance**

Wash the furniture with a solution of mild detergent and water, rinse with clear water, and dry thoroughly. To all metal frames, apply a fine, clear automobile wax for maximum protection against harmful ultraviolet exposure and salt air.

For best protection, perform this maintenance two or three times per year in low pollution areas or more frequently in high pollution areas. Please note that these durable materials can be safely cleaned as often as desired. Note: Some suntan and sun block products may be harmful to resin, cushions and strap, mesh and vinyl lace and strap. Do not allow such products to come in contact with any seating surfaces to avoid deep penetrating stains, which are not covered under warranty.

## **How to Clean & Care for Teak Furnishings**

Left alone to age, the natural color of teak furnishings will weather to a soft, silver grey. This process will take approximately nine months, depending on the degree of sunlight and rain exposure. Imperfections, which are inherent properties of the wood, will show over time, enhancing the beauty of the furniture. In humid or wet climates, or after rains, the wood may naturally expand and contract, causing the grain to rise. This is to be expected with exposure to the elements and will stabilize after the initial weathering occurs. To maintain teak furnishings, use a soft bristled utility brush and stroke lightly in the direction of the grain to remove surface dust. For more stubborn dirt, the wood may be washed with a mild solution of four parts laundry detergent or dish washing soap to one part bleach in water, then rinsed thoroughly and allowed to dry completely. Oiling the wood may cause mildew or irregular coloring.

## **How to Clean Woven Furnishings**

Woven furnishings are made of durable and weatherproof extruded polyethylene resin weave. Light stains and soils may be removed with a solution of mild detergent and water, rinsed with clear water and dried thoroughly. Mildew and heavy stains can be removed with a quality commercial outdoor furniture cleaner and protectant. Woven furnishings may not be suitable for intensely hot climates.

## **How to Clean Fabric**

Fine outdoor fabrics are designed to endure years of sun, soil and moisture. Wash outdoor cushions with a solution of mild detergent and water and thoroughly rinse with clear water. Stand cushions on end and allow to air dry completely. Light stains can be removed as above. Mildew and heavy stains can be removed with a quality commercial outdoor furniture cleaner and protectant. Note: Do not dry clean or use a washing machine or dryer. Do not steam or use water at temperatures above 100° F when washing. Note: Be careful to keep the outdoor furniture cleaner from contact with the cushions of your outdoor furniture, as it will cause discoloration. Do not use bleach on printed acrylic fabrics. Do not use solvent-type materials on woven vinyl, woven blend or ultra woven blend fabrics as they will damage the yarns. Do not use chlorine based cleaners.

## **How to Clean Mesh**

Remove light stains with a solution of mild detergent and water, then rinse with clear water and dry thoroughly. Mildew and heavy stains can be removed with a quality commercial outdoor furniture cleaner and protectant.

## **How to Clean Strap**

For general or light cleaning, begin by brushing dirt off the strap. Apply a solution of mild detergent and warm water and allow it to soak into the strap. Gently clean with a sponge or soft bristle brush, then rinse thoroughly with clear water and allow the strap to air dry.

## **How to Clean Vinyl Strap**

Apply a quality vinyl protectant to guard against the effects of air pollution, salt air build-up, and mildew. To remove difficult stains use rubbing alcohol applied with a soft cloth.

## **How to Clean & Care for Stone and Marble Tops**

Tabletops are designed for normal outdoor use in residential settings. To maintain the natural beauty we recommend resealing your table top when necessary, with the same sealer product applied during the manufacturing process. The sealer penetrates the stone and acts as a repellent, preventing absorption of moisture and stainable materials.

If tabletop is stained with products such as wine, soda, coffee, or other colorants of organic origin, clean these spills immediately with a mild detergent then rinse with water. In extreme cold climates, it is recommended that tabletops be stored in a dry indoor area or be covered with suitable outdoor furniture cover. Be sure to allow space between the tabletop and the cover so that moisture does not collect on the table; this will promote airflow and allow moisture to escape.

# PARTS IDENTIFICATION LIST

---

*\* NOTE: PARTS SHOWN ON PARTS LIST ARE NOT TO SCALE*

	<u>PARTS LIST</u>	<u>DESCRIPTION</u>	<u>ORDER PART #</u>
A		FOOT CAP <i>FACTORY ASSEMBLY</i>	FC0030



AAF06000

# ASSEMBLY INSTRUCTIONS

- 1 Place the table top upside down on a flat, non-abrasive surface. Attach a table leg to the table top by using the bolts and washers as shown in the **Figure 1**. Guide the bolts through the holes in the table leg, into the pre-drilled holes in the table top. **Hand tighten 2-3 turns only**. Repeat for the other three legs.

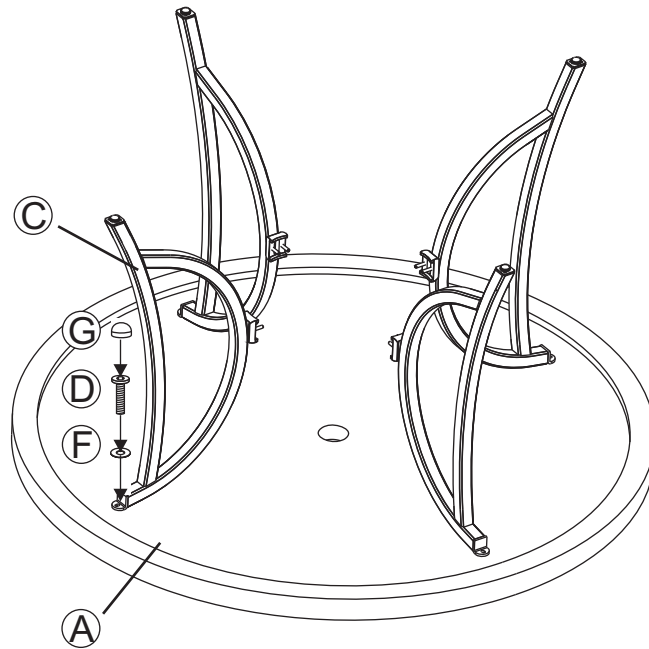

Figure 1

- 2 Attach a leg to the leg connector bracket by carefully guiding the bolts already in place on the table legs (each leg has two bolts) through the holes in the leg connector bracket. Add a washer and a nut to the end of each bolt as shown in the **Figure 2**. **Hand tighten 2-3 turns only**. Repeat on the other three legs.

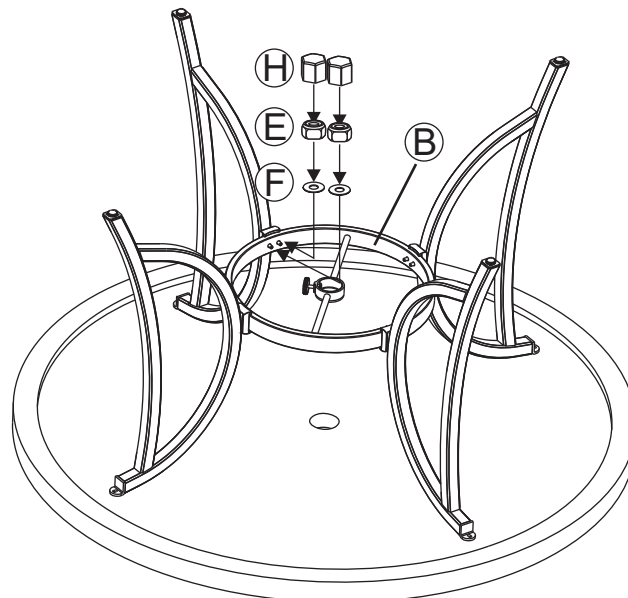
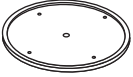
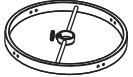











Figure 2

- 3 After making any necessary adjustments to the alignment of the table, use the hex bolt driver to tighten all bolts. Repeat until all bolts are tight. **Do not over tighten**. Over tightening may strip bolts. With the help of another person, turn the table in the upright position.

# PARTS IDENTIFICATION LIST

\* NOTE: PARTS SHOWN ON PARTS LIST ARE NOT TO SCALE

	<u>PARTS LIST</u>	<u>DESCRIPTION</u>	<u>ORDER PART #</u>	<u>QTY</u>
A		TABLE TOP	AT53135	1
B		LEG CONNECTOR BRACKET	AT53136	1
C		TABLE LEG	AT53137	4
D		1/4" X 18 MM BOLT	HW0035	4
E		1/4" NUT	HW0014	8
F		Ø6.5 X 1.0 MM WASHER	HW0004	12
G		BOLT COVER	HW0105	4
H		NUT COVER	HW0027	8
I		HEX WRENCH	HW0009	1
J		HEX BOLT DRIVER	HW0006	1
		UMBRELLA HOLE PROTECTIVE RING FACTORY ASSEMBLY	G0157	
		FOOT CAP FACTORY ASSEMBLY	FC0612	

ALT19517