

# HANOVER®

## Hanover Outdoor Furniture



### **IMPORTANT**

If you have any problems with this product (missing or damaged parts, assembly issues, etc.),

**PLEASE DO NOT RETURN TO THE RETAILER/STORE**

from where you purchased the product.

Please call our Toll-Free Customer Service Hotline at: **1-877-397-5144**

Between 9:00 AM and 5:00 PM Eastern Time, Monday through Friday

Or visit our website at: **[www.hanover-products.com](http://www.hanover-products.com)**

To expedite any future warranty claims, please retain the Instruction Sheet, Warranty Card and receipt for future use.

For additional on-line support on assembly, troubleshooting and care & maintenance of your outdoor furniture, please visit our website at: **[www.hanover-products.com](http://www.hanover-products.com)**.

# ASSEMBLY INSTRUCTIONS

1

Position the swivel base on a flat, solid surface. Make sure the swivel plate is positioned all the way into the base. It may have vibrated out during shipment. The two sets of holes in the swivel plate should be facing away from you.

Note the arrows on both the swivel plate and the "U" bar portion of the chair frame. Position the chair frame onto the swivel plate so that the two pairs of holes in the "U" bar are exactly aligned with the two pairs of holes in the swivel plate and the arrows on both the "U" bar and swivel plate are pointing in the same direction. Proper positioning of the chair frame on the swivel plate/swivel base assembly, and proper alignment of the holes in the "U" bar with the holes in the swivel plate are critical to the safe, well balanced swiveling motion of the chair.

2

Carefully examine the diagram. Attach a metal plate to two (2) bolts and guide the bolts through the top of one set of holes in the "U" bar (located at the bottom of the chair frame) and into the pair of holes in the swivel plate. From beneath the swivel plate, add a washer, then a spring washer and a nut to the end each bolt. Hand tighten 3-4 revolutions only. Repeat procedure for pair of holes on the opposite side. Again, hand tighten nuts 3-4 revolutions only. Do not tighten nuts completely.

3



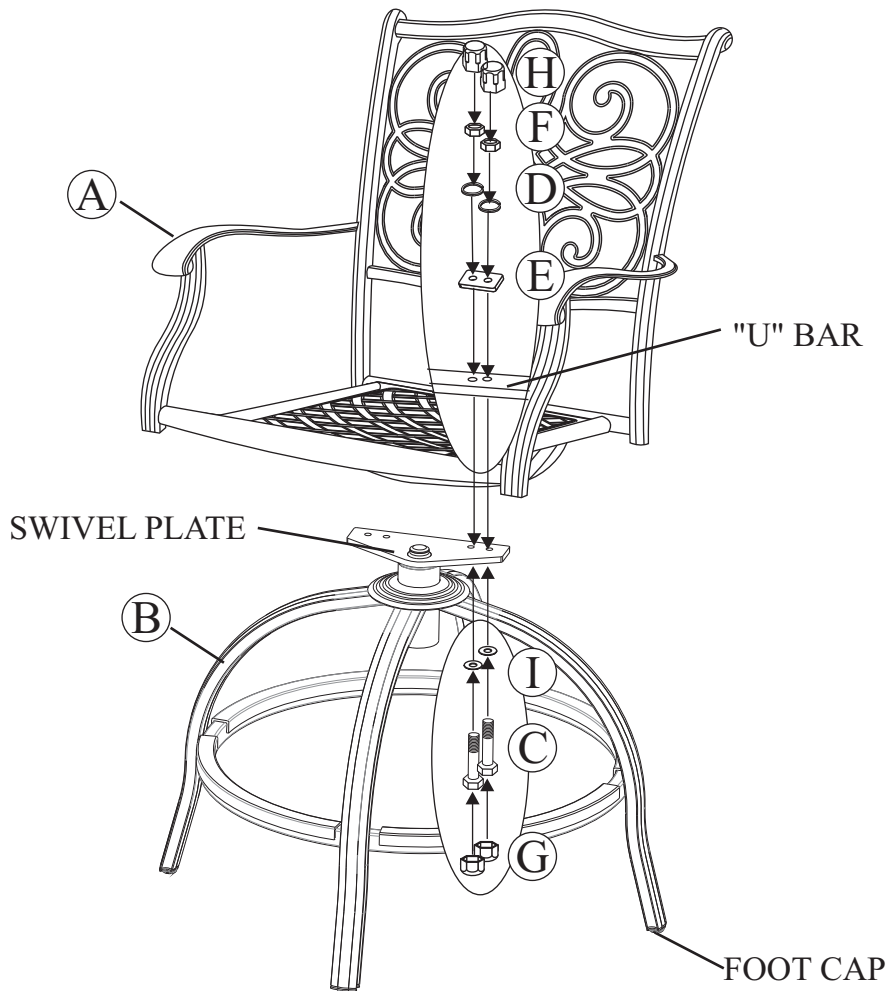







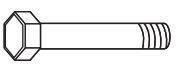

Using the hex wrenches provided, tighten the nuts and bolts. Be sure the bolts are fully tightened. Remove arrow labels from the "U" bar and swivel plate. Cover bolts and nuts with covers. Your chair is now ready for use.



## PARTS IDENTIFICATION LIST

---

\* NOTE: PARTS SHOWN ON PARTS LIST ARE NOT TO SCALE

	<u>PARTS LIST</u>	<u>DESCRIPTION</u>	<u>ORDER PART #</u>	<u>QTY</u>
A		CHAIR FRAME	AB1267	1
B		SWIVEL ASSEMBLY & BASE	AB1268	1
C		5/16" X 43 MM BOLT	HW0450	4
D		Ø8.0 X 2.3 MM SPRING WASHER	HW0003	4
E		METAL PLATE	HW0686	2
F		5/16" NUT	HW0015	4
G		BOLT COVER	HW0028	4
H		NUT COVER	HW0109	4
I		Ø8.5 X 1.5 MM WASHER	HW0005	4
J		HEX WRENCH-1	HW0008	1
K		HEX WRENCH-2	HW0007	1
		FOOTREST COVER <i>FACTORY ASSEMBLY</i>	G0304	
		FOOT CAP <i>FACTORY ASSEMBLY</i>	FC0030	

## ASSEMBLY INSTRUCTIONS

---

- 1 Attach a table leg to the leg connector bracket by using two 1/4"x30 mm bolts and Ø6.5x1.0 mm washers as shown in **Fig 1**. Guide the bolts through holes in leg connector brackets into pre-drilled holes in the legs. **Hand tighten only**. Repeat for other three table legs.

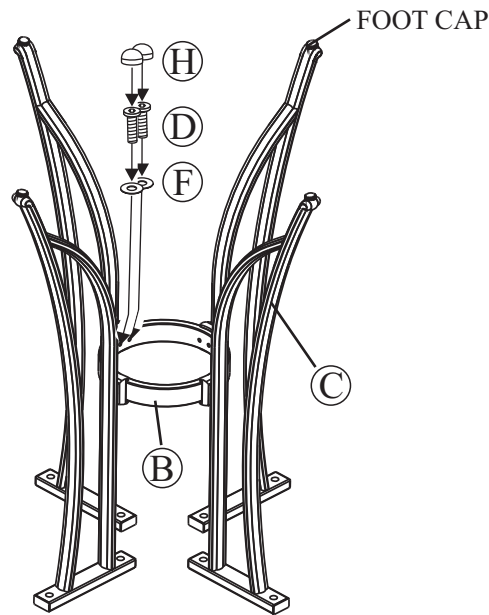

- 2 Place the table top upside down on a flat, non-abrasive surface. Attach a table leg to the table top by using two 1/4"x35 mm bolts and Ø20xØ6.5x2.0 mm washers as shown in **Fig.2**. Guide the bolts through the holes in the table leg into the pre-drilled hole in the table top. **Hand tighten only**. Repeat for the other table legs.

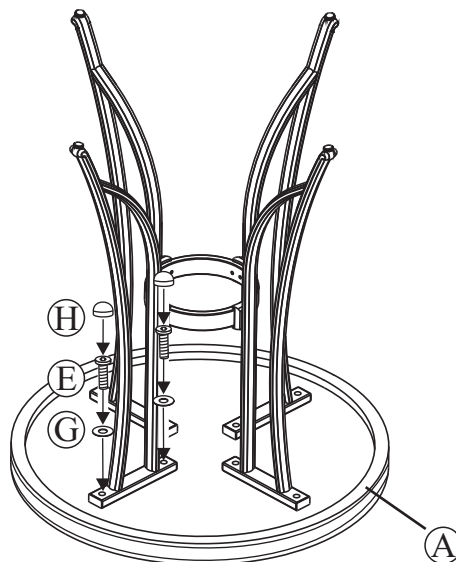









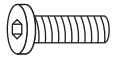

- 3 After making any necessary adjustments to the alignment of the table, use the hex bolt driver and hex wrench to tighten all bolts. **Note:** each bolt must be tightened a few revolutions at a time. In order to apply equal pressure to all bolt joints, we recommend working in a cross corner (X fashion). Repeat until all bolts are tight. **Do not over tighten**. Over tightening may strip bolts. Cover all bolts with covers.

## PARTS IDENTIFICATION LIST

---

\* NOTE: PARTS SHOWN ON PARTS LIST ARE NOT TO SCALE

	<u>PARTS LIST</u>	<u>DESCRIPTION</u>	<u>ORDER PART #</u>	<u>QTY</u>
A		TABLE TOP	AT52583	1
B		LEG CONNECTOR BRACKET	AT52584	1
C		TABLE LEG	AT52585	4
D		1/4" X 30 MM BOLT	HW0038	8
E		1/4" X 35 MM BOLT	HW0142	8
F		Ø6.5 X 1.0 MM WASHER	HW0004	8
G		Ø20 X Ø6.5 X 2.0 MM WASHER	HW0594	8
H		BOLT COVER	HW0105	16
I		HEX BOLT DRIVER	HW0006	1
J		TOUCH-UP PAINT	G0003	1
		FOOT CAP FACTORY ASSEMBLY	FC0069	