

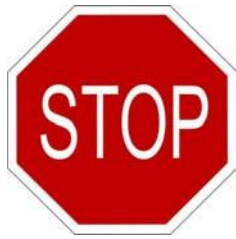

## Hanover Outdoor Furniture



### **IMPORTANT**

If you have any problems with this product (missing or damaged parts, assembly issues, etc.),

**PLEASE DO NOT RETURN TO THE RETAILER/STORE**

from where you purchased the product.

Please call our Toll-Free Customer Service Hotline at: **1-877-397-5144**

Between 9:00 AM and 5:00 PM Eastern Time, Monday through Friday

Or visit our website at: **[www.hanover-products.com](http://www.hanover-products.com)**

To expedite any future warranty claims, please retain the Instruction Sheet, Warranty Card and receipt for future use.

### **Care and Maintenance**

Store furniture in an upright position. Be careful to never allow water to build up in frames as this will cause corrosion and freeze damage in cold climates. Wash all frames with a solution of mild soap and water. Rinse with clean water and dry with a soft absorbent cloth towel. Frames can be treated with a liquid wax for maximum protection against UV rays and/or salty, damp air. If your set includes cushions, slings, and/or an umbrella they may be cleaned by hand with a solution of soap and water with a clean water rinse. (Never machine wash cushions, slings or umbrella covers as this will result in shrinkage or damage). After cleaning cushions tip on end and allow to drip dry. (Never use a commercial or home dryer to tumble dry fabric goods). Do not use bleach or solvents to clean any product! This will void the warranty.

For additional on-line support on assembly, troubleshooting and care & maintenance of your outdoor furniture, please visit our website at: **[www.hanover-products.com](http://www.hanover-products.com)**.



# Hanover Outdoor Furniture

## 1-Year Limited Warranty Program

For a period of one (1) year after purchase, Hanover ("Manufacturer") will either repair or replace defective components in accordance with this Limited Warranty. This warranty is between Manufacturer and the original purchaser and is valid only when accompanied by the original purchaser's sales receipt showing original date of purchase and location of purchase. Replacements under this warranty revert back to the date of original purchase for future warranty.

Manufacturer or its authorized dealer can accept or reject warranty claims based on its findings. This warranty applies in normal residential use only and is not intended for commercial use. Manufacturer can make substitutions as required of materials, components, and sub-components of comparable value and utility. This warranty is limited to product repair or replacement (to be determined solely by Manufacturer). Warranty return is limited to only the single affected component.

This warranty covers only manufacturing defects and does not cover normal wear and tear, damage due to acts of nature (such as, but not limited to freezing or high winds), abuse or misuse, including chemical damage from suntan oil or other chemicals, exposure to extreme heat or cold, abrasion or excessive weight. This product is intended to be used in standard installations only. This warranty is invalid if the product is not used for intended purpose. Manufacturer disclaims liability for any aspect of installation and any inconvenience caused by a defective part of a component.

Certain items are not covered by this warranty. These include, but are not limited to the following:

1. Components subjected to abuse, including abuse intended to simulate failure.
2. Damages caused by retailer, shipper or installation crew (such as scratches, dents, tears, chips, etc.).
3. Any part which merely exhibits normal wear yet functions essentially as new, including chips, scratches or stretching of materials and stitching.
4. Tears, punctures, scratches or any damage caused by improper installation or use.
5. Damage to frames/welds resulting from improper assembly or exposure to water and/or sub-freezing temperatures is not covered. General frame rusting is not covered.
6. Fading and/or discoloration of fabrics/cushions/straps/wicker resulting from exposure to the elements, chemicals, oils, fluids or any other cause are not covered.
7. Umbrella bases are not covered under any circumstances.
8. Items sold "as is" or floor models.

To make a claim, call the toll-free number below. Please have available a copy of the original sales receipt along with a brief description of the problem. Please also provide your email address and daytime telephone or cell phone#. All items may be charged actual freight costs plus \$15 for handling. Repairs or replacement will be made at the Manufacturer's option. ***Sales and use taxes, plus shipping and handling charges are the responsibility of the consumer.***

**THIS IS THE ENTIRE EXCLUSIVE EXPRESS LIMITED LIABILITY. THE MANUFACTURER NEITHER MAKES NOR IS RESPONSIBLE FOR ANY OTHER WARRANTIES, EITHER EXPRESS OR IMPLIED, INCLUDING THOSE OF RETAILING DEALERS. THIS EXCLUSIVE REMEDY IS LIMITED TO RECEIPT OF A CREDIT IN CONNECTION WITH THE REPAIR OR REPLACEMENT OF ANY PRODUCT OR COMPONENT DEEMED TO BE DEFECTIVE UNDER THE TERMS AND CONDITIONS AS STATED IN THIS WARRANTY. NEITHER HANOVER, THE PRODUCT MANUFACTURER NOR ITS AGENTS SHALL BE LIABLE IN ANY CASE FOR INCIDENTAL, INDIRECT, SPECIAL OR CONSEQUENTIAL DAMAGES RESULTING FROM THE USE OF THIS PRODUCT OR ARISING OUT OF ANY BREACH OF THIS WARRANTY OR NEGLIGENCE EVEN IF IT HAS BEEN ADVISED OF THE POSSIBILITY OF SUCH DAMAGES. EXCEPT AS OTHERWISE MAY BE REQUIRED BY LAW, THERE ARE NO OTHER EXPRESS OR IMPLIED WARRANTIES OTHER THAN THE WARRANTY DESCRIBED HEREIN, AND ALL OTHER WARRANTIES, INCLUDING ANY IMPLIED WARRANTY OF MERCHANTABILITY OR FITNESS FOR A PARTICULAR PURPOSE ARE EXPRESSLY DISCLAIMED.**

Contact Warranty Services at **1-877-397-5144**

or

**[www.hanover-products.com](http://www.hanover-products.com)**



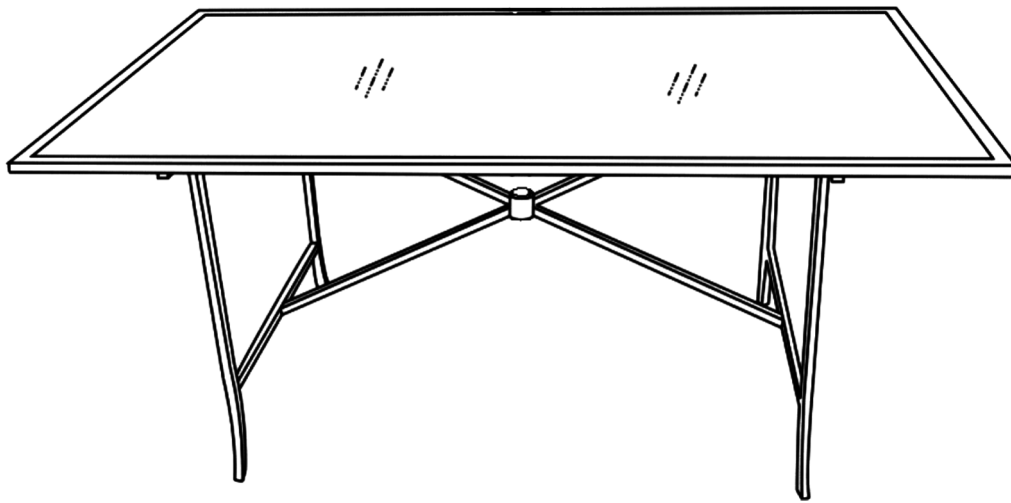

# Patio Dining Table

## Owner's Manual

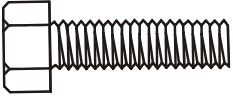
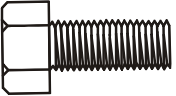

If you have any problems with this product, DO NOT RETURN IT TO THE STORE.  
CALL OUR CUSTOMER SERVICE HOT-LINE AT  
**1-877-397-5144**  
8am-5pm (EST), Monday-Thursday, 8am-4pm (EST), Friday

## Parts List

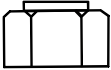
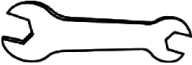
PART NAME	DESCRIPTION	PICTURE	QTY
A		Table Rim and Glass Top	1
B		Leg Connector	1
C		Table Leg	2
D		Long Bolt M6x35 mm	4
E		Short Bolt M6x20 mm	4
F		Washer (M6)	8
G		Bolt cap	8
H		Hex Wrench	1

**Don't tighten Bolts until Product is completely assembled.**

Step 1. Take the plastic glass clamp off from the table rim (A), then take the glass top away from the table rim and place the Glass top on a soft surface carefully.

Step 2. Turn the table rim upside down (See figure 1)

Step 3. Assemble the table legs (C) to table rim (A) with M6x35mm bolts (D) and hex wrench (H) as shown in figure 1.

Step 4. Assemble the leg connector (B) to table legs (C) with M6x20mm bolts (E) and hex wrench (H) as shown in figure 1.

**NOTE:** Please be sure the side with the drain holes on the leg connector (B) is facing down after the table is assembled and in the upright position!

Failure to do this can lead to freeze damage which is not warranted.

Step 5. Tighten all bolts with hex wrench.

Figure 1

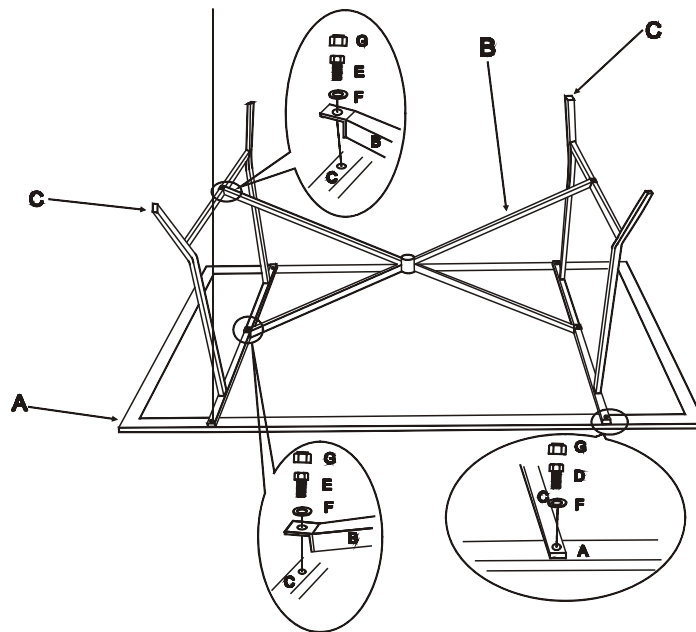

Step 6. Cover all bolt heads with bolt caps (G) provided.

Step 7. Verify all bolts are securely tightened before use.

Step 8. Turn your table right side up, Place the glass top on the table rim (See Figure 2).

Figure 2

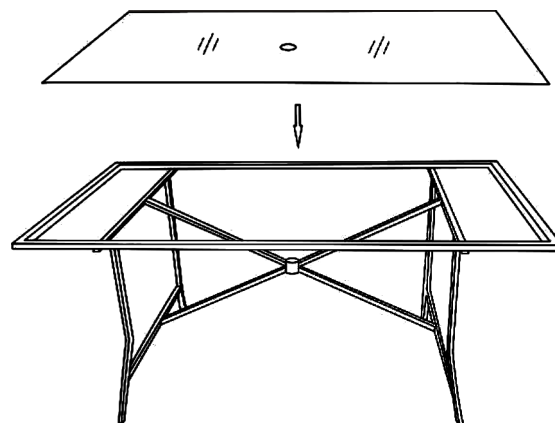

**Now your table is ready for your enjoyment!**

**WARNING:**

**Do not crawl, stand, or sit on glass table tops.**

**Do not set or lay heavy items on glass table tops.**

**Avoid extreme hot & cold items being placed on glass table tops.**

**This glass table top is produced with tempered glass which is designed to safely shatter in small pieces when impacted or stressed beyond strength limitations.**

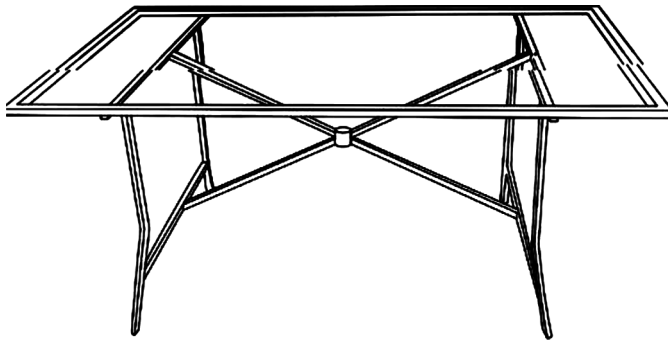



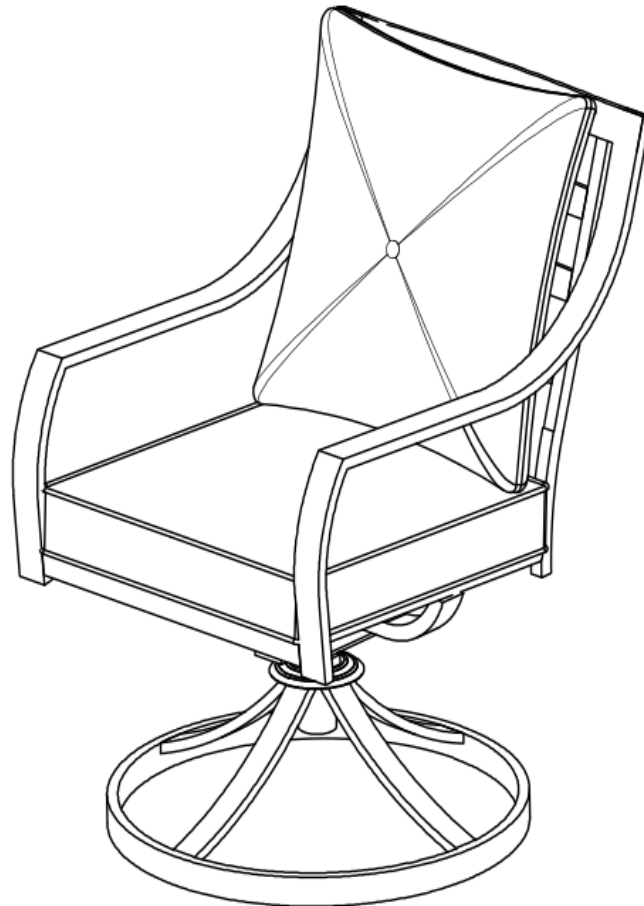







# Swivel Dining Chair Owner's Manual

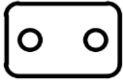

If you have any problems with this product, DO NOT RETURN IT TO THE STORE  
CALL OUR CUSTOMER SERVICE HOT-LINE AT  
1-877-397-5144

Between 9 A.M. - 5 P.M. Eastern Time, Monday through Friday

# PARTS LIST

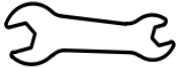
PART#	DESCRIPTION	PICTURE	QTY
A	Chair Frame		1
B	T Rocker		1
C	Base		1
D	Steel Panel		4
E	Seat Cushion		1
F	Back Cushion		1
AA	Bolt M8 x 45mm		4
BB	M8 Washer		8
CC	M8 Spring Gasket		4
DD	M8 Nut		4
EE	M8 Bolt Cover		4
FF	Bolt Cover For M8 Nut		4
GG	Open Wrench		1



**Assembly Steps:**

**Note: Do not fully tighten bolts until assembly is completed and alignment is correct.**

Step 1. Carefully place the chair frame (A) upside down on a non-abrasive surface. Assemble the T rocker(B) to the chair frame(A) with steel panel(D) and Bolts(AA) and Washer(BB) and M8 Spring gasket (CC) and M8 Nut(DD) by using open wrench(GG), then cover the bolts with bolt covers (EE and FF) as shown in Figure 1.

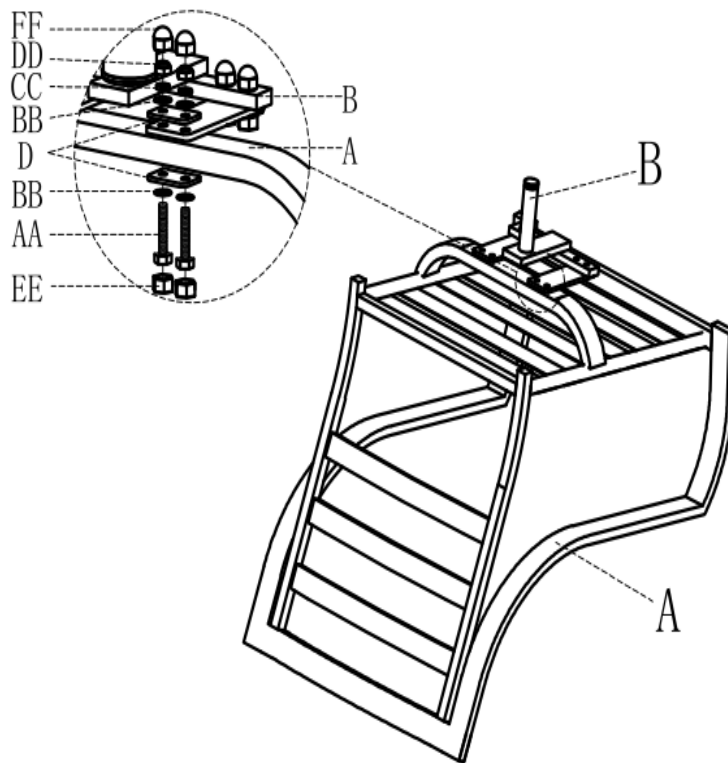

Figure 1

Step 2. Place the chair frame (A) into the base (C) as shown in Figure 2 .

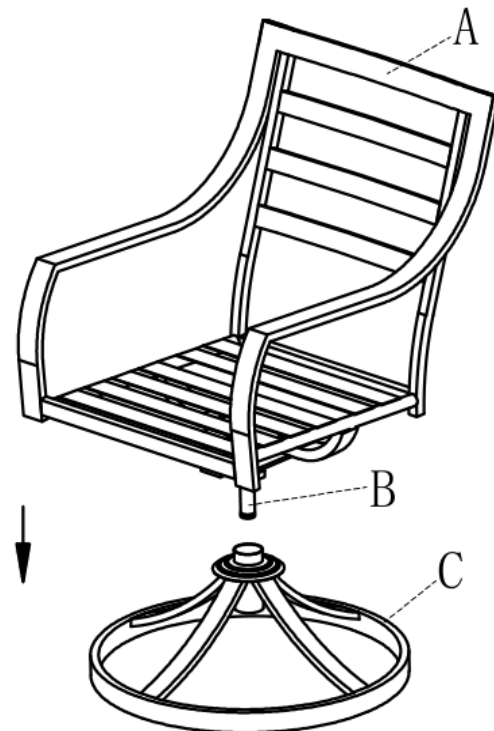

Figure 2

Step 3. Put seat cushion( E ) and back cushion ( F ) in chair.  
Your chair is now ready to use. (Figure 3).

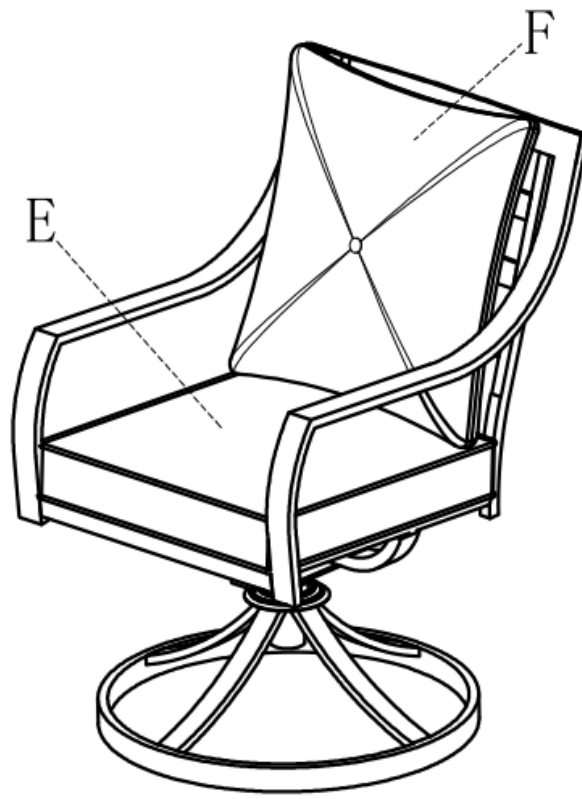
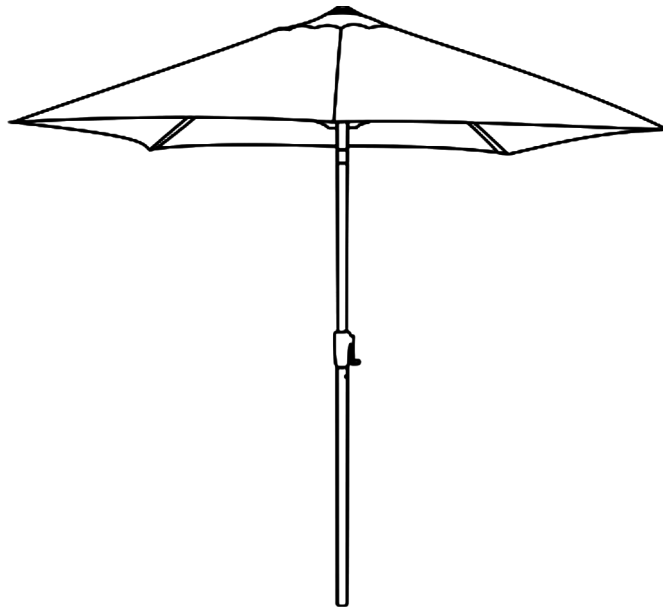

Figure 3

# Umbrella Owner's Manual





If you have any problems with this product, DO NOT RETURN IT TO THE  
STORE. CALL OUR CUSTOMER SERVICE HOT-LINE AT:

1-866-851-8438

8am-5pm (EST), Monday-Thursday

8am-4pm (EST), Friday.

# PARTS LIST

Part	Description	Picture	Quantity
A	Support tube		1
B	Umbrella		1

## Assembly Steps:

Step 1:

Part# A x 1



Part# B x 1

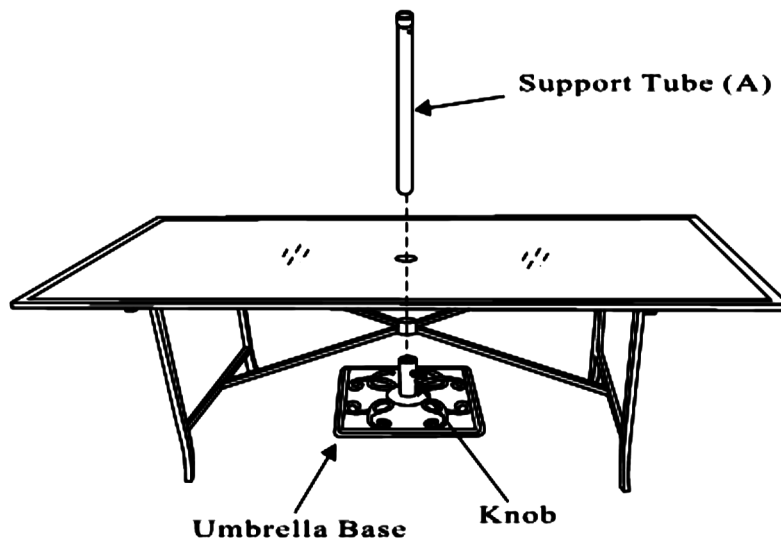

Step 2:

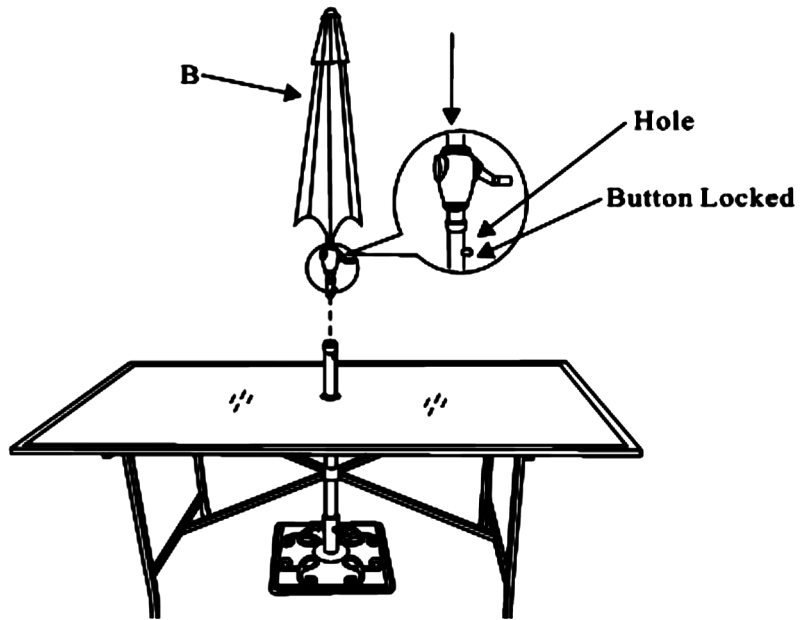

Step 3:

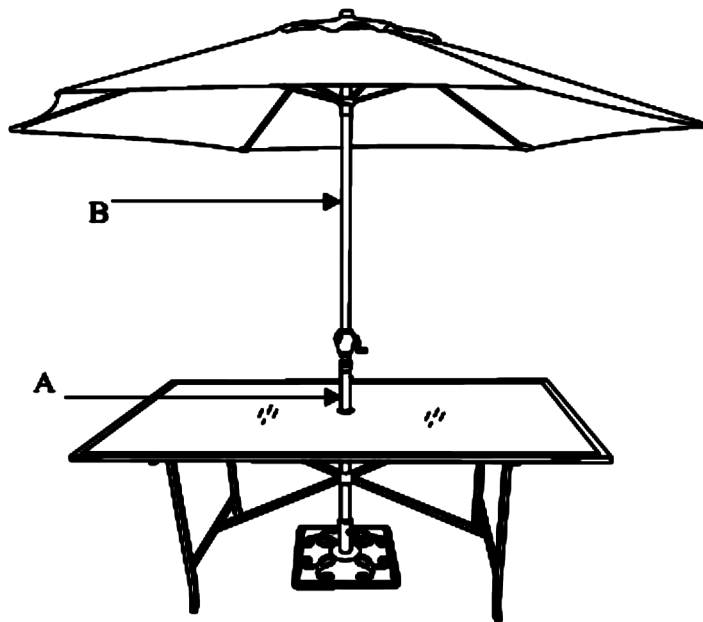

**Figure 3**

**Warning:**

Please remove Umbrella from Table when not in use and store in a safe place to ensure longevity.  
Always leave your umbrella in the down position when not in use.  
Never use umbrella in high wind conditions. As this could result in damage to umbrella and / or your table.  
**Never use your umbrella without umbrella base & table.**