

HANOVER[®]

Assembly & Care Guide For Gaming Chair



The model number of your chair is printed on the side of your carton.

Always use this number to identify your chair.

Thank you for your purchase of this quality office furniture. With proper use and care, your chair will provide you with years of use. Please follow the instructions on how to assemble and disassemble your chair. If you should have any problems with your chair DO NOT return it to the place of purchase. Please call our toll-free number: **877-397-5144** and a customer service representative will assist you.



Warning: Risk of Suffocation!

Keep any packing materials away from children - these materials are a potential source of danger, including suffocation.



















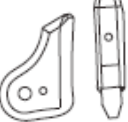
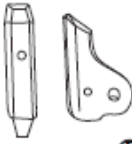

Safety Information

- For domestic and office use only.
- A competent adult must assemble this chair.
- Keep children and pets away while assembling the chair.
- Do not let children climb on or play with the chair.
- Always use your chair on a firm, level surface.
- Do not use this chair if any parts are missing, damaged, or worn.
- Do not overtighten the fasteners.
- Regularly examine the chair for wear and tear. Stop using at first sign of damage or if parts become detached.
- Do not stand on the seat.
- Do not sit on the armrest.
- This chair is intended for users up to 250 lbs.
- Any other use is at user's risk.

Cleaning Information

- To clean wipe with a soft, slightly damp cloth.
- Never use corrosive detergents, wire brushes, abrasive cleaners, metal, or sharp utensils to clean your chair.

Model:9810106

 1	 2	 3	 4	 5	 6	
 7	 5PCS 8	 9	 10	 11	 12	  13
 M8*30 8PCS A	 M8*20 12PCS B	 M8*18*1.5 20PCS C	 M8 20PCS D	 M5*8 4PCS E	 4PCS F	 M6 G
 H						

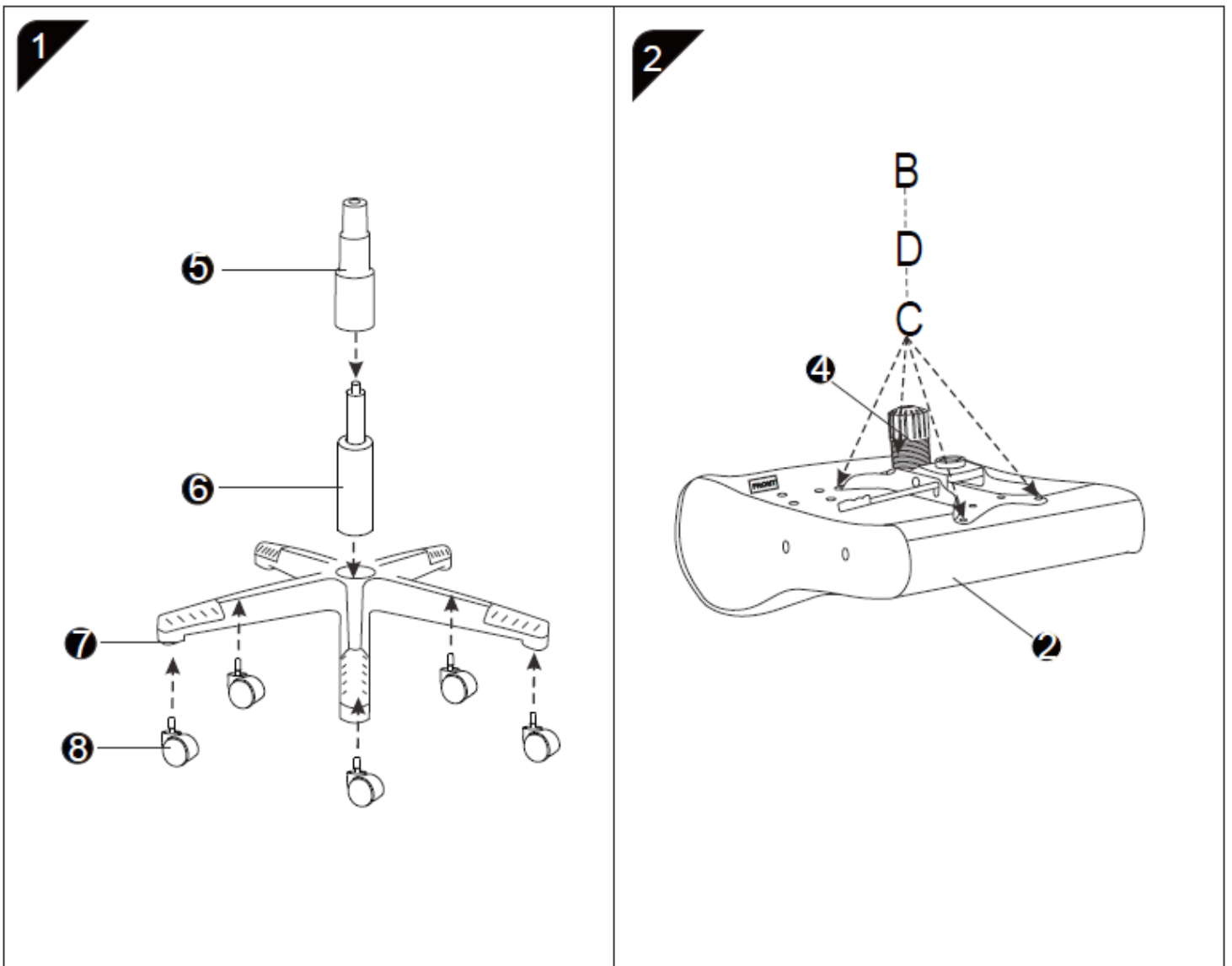

3

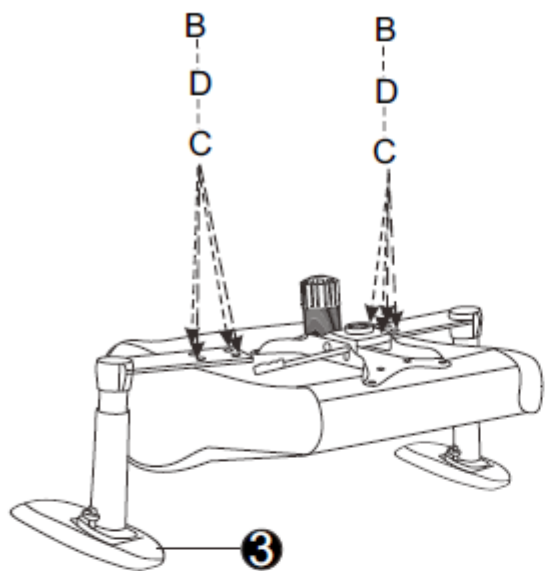

4

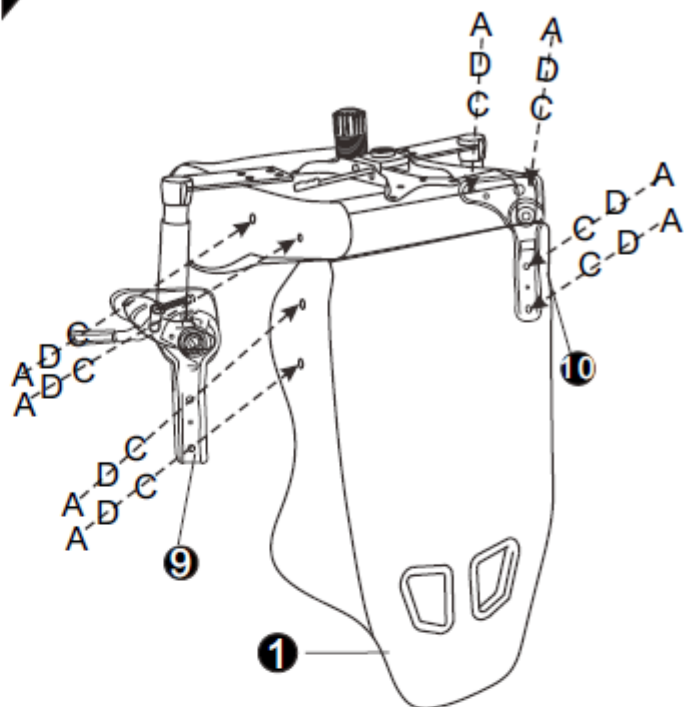

5

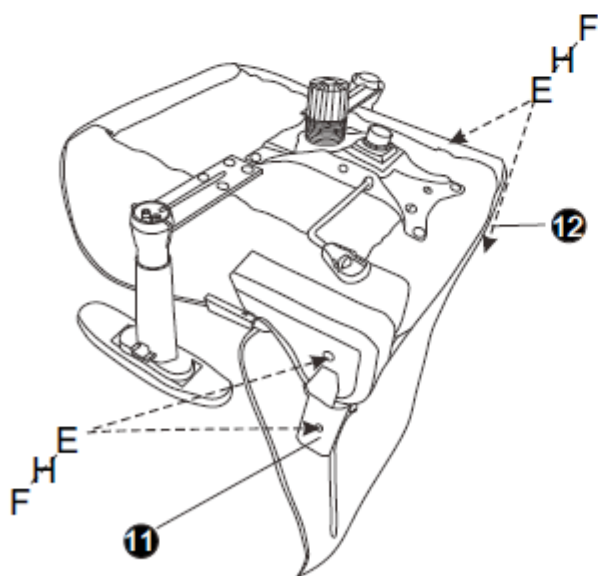

6

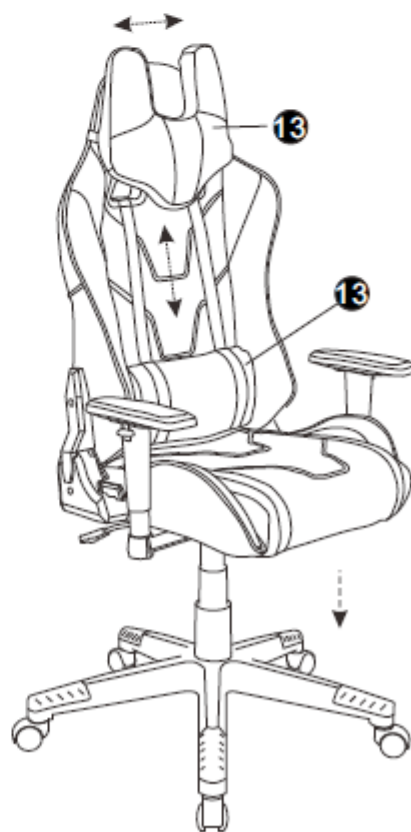

Office Furniture Warranty

2-Year Limited Warranty Program

For a period of two (2) years after purchase, Hanover Products, Inc. ("Manufacturer") will either repair or replace defective components in accordance with this Limited Warranty. This warranty is between Manufacturer and the original purchaser and is valid only when accompanied by the original purchaser's sales receipt showing original date of purchase and location of purchase. Replacements under this warranty revert back to the date of original purchase for future warranty.

Manufacturer or its authorized dealer can accept or reject warranty claims based on its findings. This warranty applies in normal office use only and is not intended for industrial or public use. Manufacturer can make substitutions as required of materials, components, and sub-components of comparable value and utility. This warranty is limited to product repair or replacement (to be determined solely by Manufacturer). Warranty replacement is limited to only the single affected component.

This warranty covers only manufacturing defects and does not cover normal wear and tear, abuse or misuse, exposure to extreme heat or cold, abrasion or excessive weight. This product is intended to be used in standard installations only. This warranty is invalid if the product is not used for intended purpose. Manufacturer disclaims liability for any aspect of installation and any inconvenience caused by a defective part of a component.

Certain items are not covered by this warranty. These include, but are not limited to the following:

1. Components subjected to abuse, including abuse intended to simulate failure.
2. Damages caused by retailer, shipper or installation crew (such as scratches, dents, tears, chips, etc.).
3. Any part which merely exhibits normal wear yet functions essentially as new, including chips, scratches or stretching of materials and stitching.
4. Tears, punctures, scratches or any damage caused by improper installation or use.
5. Damage to frames/welds resulting from improper assembly is not covered. General frame rusting is not covered.
6. Fading and/or discoloration of fabrics resulting from exposure to the elements, chemicals, oils, fluids or any other cause are not covered.

To make a claim, call the toll-free number below. Please have available a copy of the original sales receipt along with a brief description of the problem. Please also provide your email address and daytime telephone or cell phone#. All items may be charged actual freight costs plus \$15 for handling. Repairs or replacement will be made at the Manufacturer's option. *Sales and use taxes, plus shipping and handling charges are the responsibility of the consumer.*

THIS IS THE ENTIRE EXCLUSIVE EXPRESS LIMITED LIABILITY. THE MANUFACTURER NEITHER MAKES NOR IS RESPONSIBLE FOR ANY OTHER WARRANTIES, EITHER EXPRESS OR IMPLIED, INCLUDING THOSE OF RETAILING DEALERS. THIS EXCLUSIVE REMEDY IS LIMITED TO RECEIPT OF A CREDIT IN CONNECTION WITH THE REPAIR OR REPLACEMENT OF ANY PRODUCT OR COMPONENT DEEMED TO BE DEFECTIVE UNDER THE TERMS AND CONDITIONS AS STATED IN THIS WARRANTY. NEITHER HANOVER PRODUCTS, INC., THE PRODUCT MANUFACTURER NOR ITS AGENTS SHALL BE LIABLE IN ANY CASE FOR INCIDENTAL, INDIRECT, SPECIAL OR CONSEQUENTIAL DAMAGES RESULTING FROM THE USE OF THIS PRODUCT OR ARISING OUT OF ANY BREACH OF THIS WARRANTY OR NEGLIGENCE EVEN IF IT HAS BEEN ADVISED OF THE POSSIBILITY OF SUCH DAMAGES. EXCEPT AS OTHERWISE MAY BE REQUIRED BY LAW, THERE ARE NO OTHER EXPRESS OR IMPLIED WARRANTIES OTHER THAN THE WARRANTY DESCRIBED HEREIN, AND ALL OTHER WARRANTIES, INCLUDING ANY IMPLIED WARRANTY OF MERCHANTABILITY OR FITNESS FOR A PARTICULAR PURPOSE ARE EXPRESSLY DISCLAIMED.

Contact Warranty Services at: **ContactUs@Hanover-Products.com**
1-877-397-5144